

playmobil®

9387



WARNING:
CHOKING HAZARD

Small parts. Not for children under 3 years.

"Ne concerne que les USA"

Wichtige Unterlagen, bitte sorgfältig aufbewahren!
Important: Please keep these instructions for future reference!
Documents importants, à conserver soigneusement!
Belangrijke documenten, bewaar deze zorgvuldig!



5159
7350



- Nachrüstbar mit Unterwassermotor
- Compatible with the underwater motor (sold separately)
- Monteur submersible, vendu séparément, s'adapte sur ce bateau



Ghostbusters™ & © 2018 Columbia Pictures Industries, Inc. All rights reserved.

1

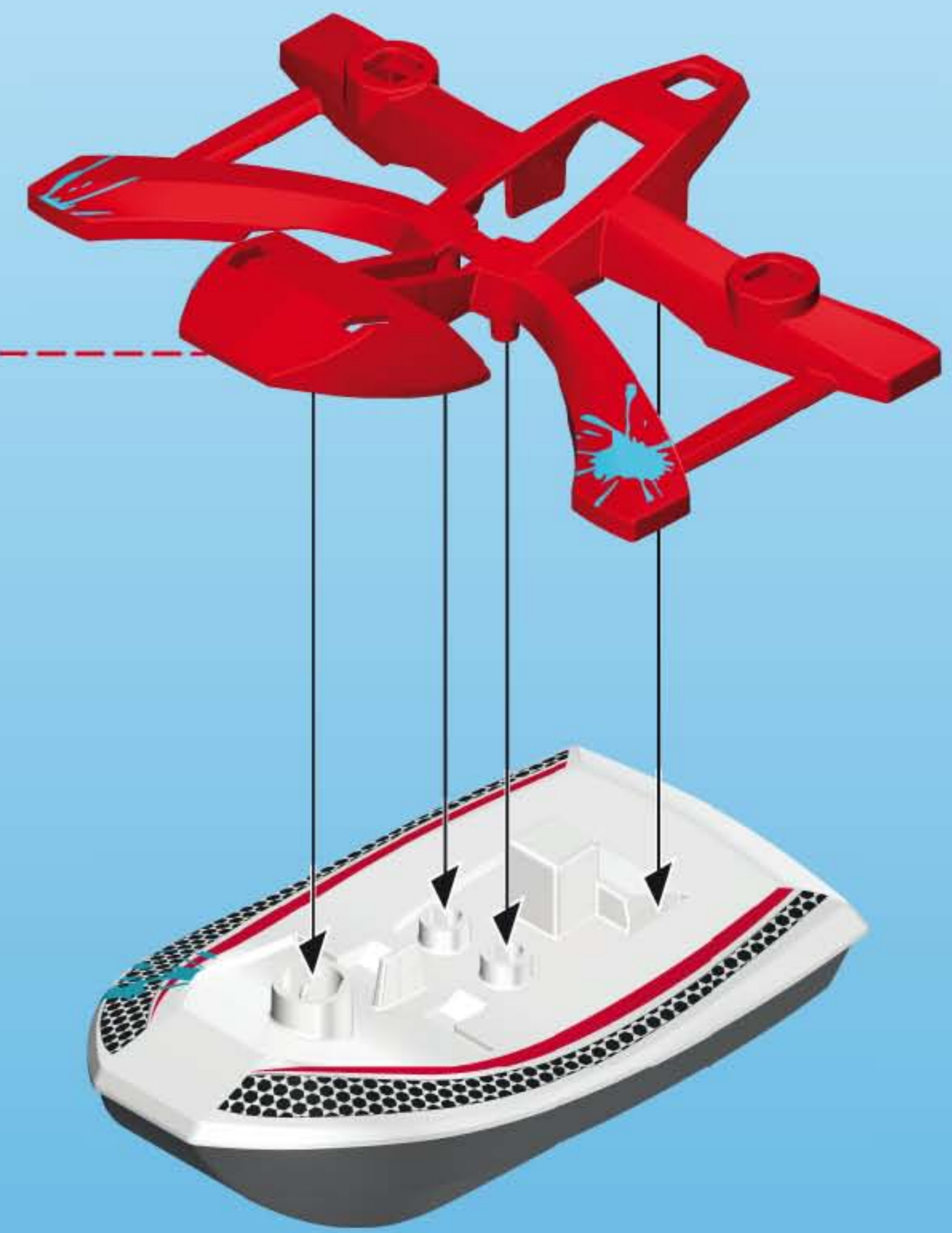
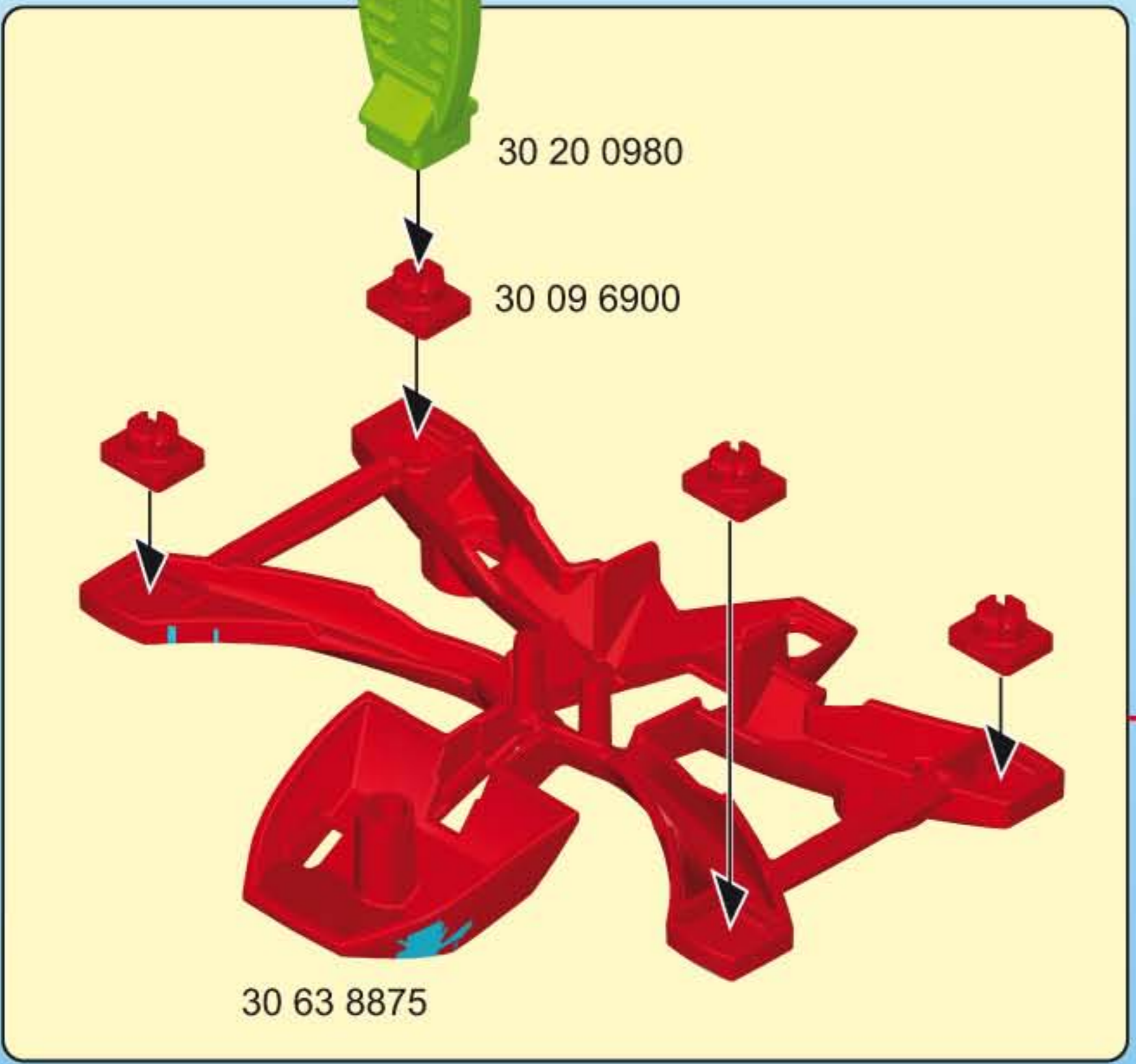

2

2



3

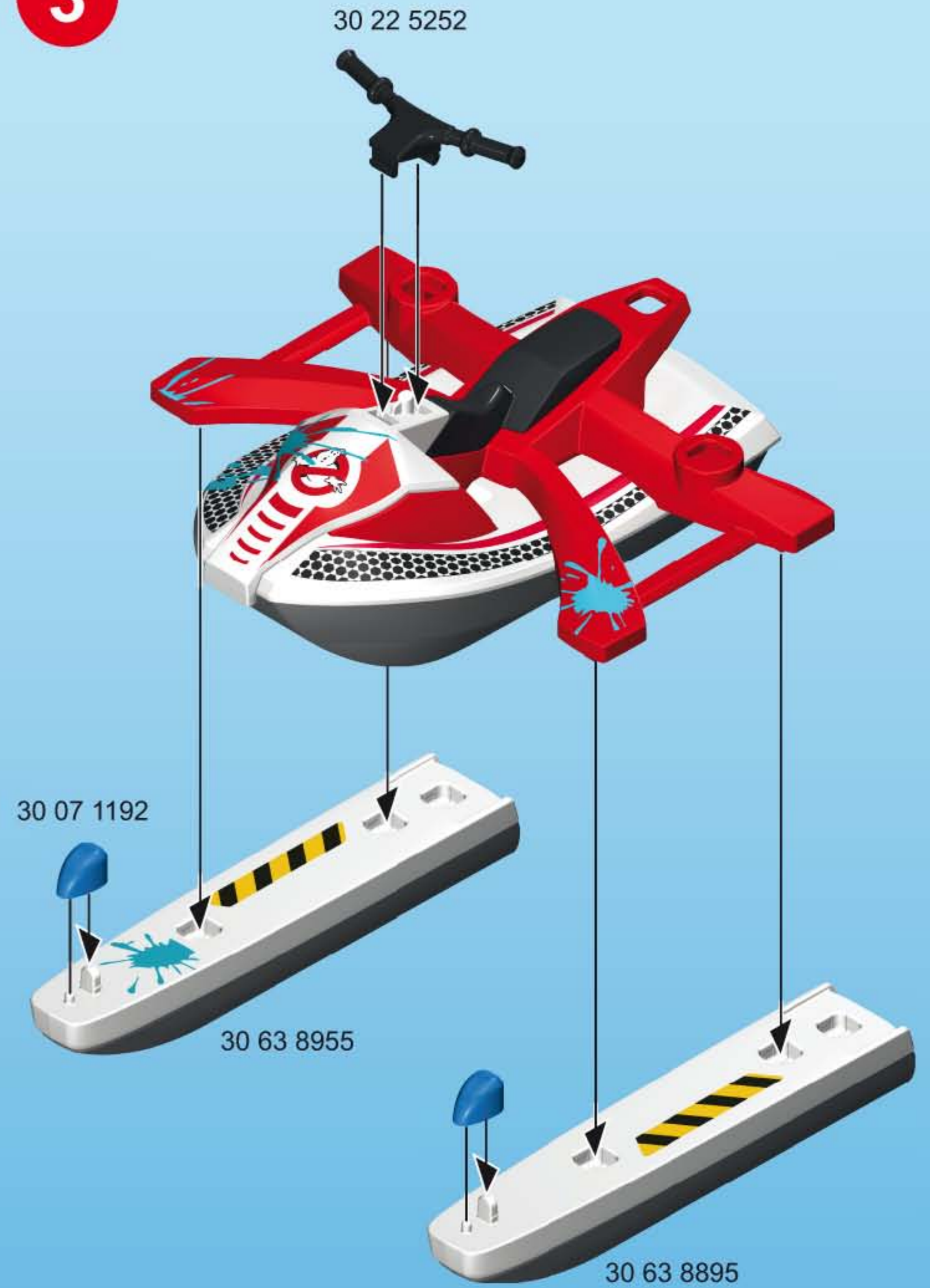

4

2x

1

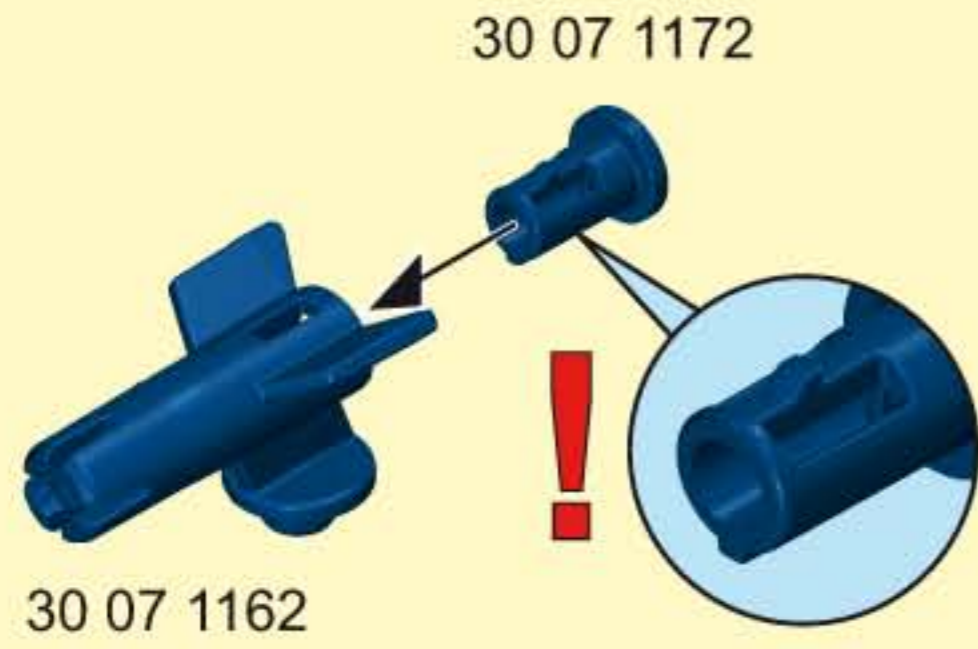

2



3

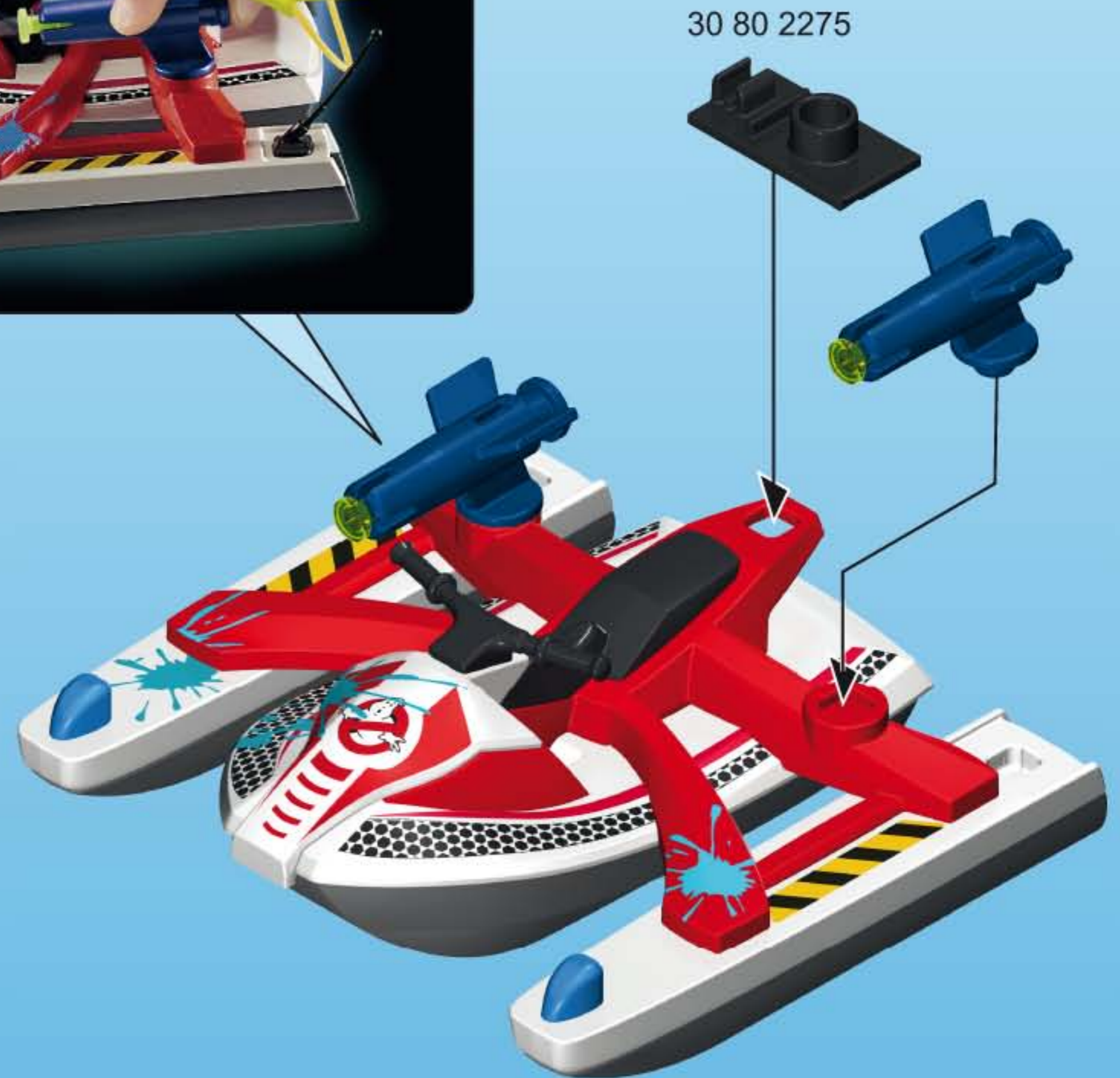
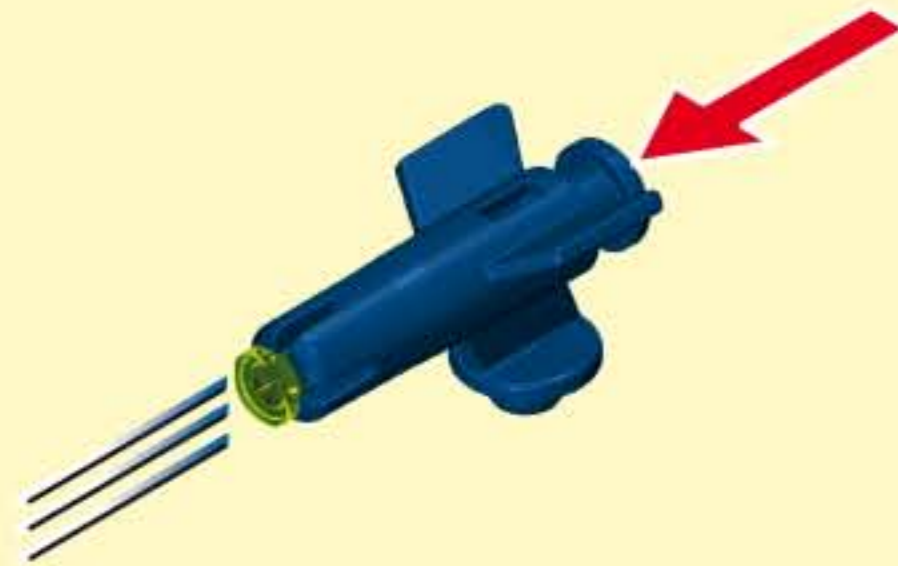

D A CH L B ACHTUNG!

- Nur im flachen Wasser unter Aufsicht von Erwachsenen verwenden. Nach dem Spielen austrocknen lassen.
- Nur mitgelieferte PLAYMOBIL Geschosse verwenden. Nicht auf Augen oder Gesicht zielen.

USA GB CDN M IRL WARNING!

- Only to be used in water in which the child is within its depth and under adult supervision. Dry thoroughly after play.
- Only use the PLAYMOBIL projectiles supplied. Do not aim at eyes or face.

F CDN B L CH ATTENTION!

- À n'utiliser qu'en eau où l'enfant a pied et sous la surveillance d'un adulte. Faire sécher après chaque utilisation.
- Seulement utiliser les projectiles PLAYMOBIL fournis. Ne pas viser les yeux ou le visage.

E MEX ¡ADVERTENCIA!

- Utilizar sólo en agua donde el niño pueda permanecer de pie y bajo vigilancia de un adulto. Dejar secar antes de guardar.
- Utiliza únicamente los proyectiles PLAYMOBIL suministrados. No apuntar a los ojos ni a la cara.

NL B WAARSCHUWING!

- Gebruiken in water waar kinderen kunnen staan en onder toezicht van volwassenen. Na het spelen laten drogen.
- Uitsluitend meegeleverde PLAYMOBIL delen gebruiken. Niet op ogen of gezicht richten.

I CH AVVERTENZA!

- Da utilizzare unicamente in acqua dove il bambino tocca il fondo con i piedi e sotto la sorveglianza di un adulto. Asciugare bene dopo ogni uso.
- Usare soltanto i proiettili PLAYMOBIL in dotazione. Non mirare agli occhi o al viso.

P ATENÇÃO!

- Só utilizar em água onde a criança tenha pé e sob vigilância de adultos. Deixar secar antes de guardar.
- Usar apenas os projécteis PLAYMOBIL juntamente fornecidos. Não apontar para os olhos ou face.

DK ADVARSEL!

- Må kun anvendes under opsyn af en voksen og på vanddybder, hvor barnet kan bunde. Lad det tørre ud når du er færdig med at lege.
- Anvend kun de medfølgende PLAYMOBIL projektiler. Sigt ikke mod øjne eller ansigt.

N ADVARSEL!

- Skal kun brukes i vann som ikke er for dypt for barnet, og der barnet er under tilsyn. Tørk opp etter at leken er ferdig.
- Benytt kun PLAYMOBIL prosjektil som leveres med. Sikt ikke på ansikt eller øyne.

S FIN VARNING!

- Får endast användas i vatten där barnet bottnar och under tillsyn av en vuxen. Låt torka efter användandet.
- Använd endast medlevererade PLAYMOBIL-skott. Sikta inte mot ögon eller ansikte.

FIN VAROITUS!

- Lelua saa käyttää vain aikuisen valvonnassa vedessä, jossa lapsi ylettyy pohjaan. Anna kuivua leikin jälkeen.
- Käytä vain mukana toimitettuja PLAYMOBIL-ammuksia. Ei saa kohdistaa suoraan silmiin tai kasvoihin.

H FIGYELMEZTETÉS.

- Csak a gyermek magasságához képest biztonságos sekély vízben és felnőtt felügyelete mellett szabad használni! Játék után ajánlott a termék kiszárítása!
- Csak a csomagban található PLAYMOBIL lövedékeket szabad használni. Tilos szemre vagy arcra célozni.

CZ UPOZORNĚNÍ!

- Používat pouze ve vodě takové hloubky, kde dítě stačí, a pouze pod dohledem dospělé osoby. Po hraní nechat vyschnout.
- Používejte pouze střely PLAYMOBIL, které jsou součástí dodávky. Nemiřte na oči nebo na obličej!

EST HOIATUS!

- Kasutada ainult täiskasvanu järelevalve all vees, kus laps ulatub jalgadega põhja. Mängimise järel kuivatada!
- Kasutage ainult kaasaantud PLAYMOBIL'i laskemoona. Ära sihi silmadesse ega näkku.

LV BRĪDINĀJUMS!

- Lietot tikai seklā ūdenī un pieaugušo uzraudzībā. Pēc spēlēšanās ļaut nožūt.
- Izmantot tikai PLAYMOBIL piegādes komplektā iekļautos šāviņus. Nevērst pret acīm vai seju.

LT ĮSPĖJIMAS!

- Naudoti tik vaikui tinkamame gylyje ir prižiūrint suaugusiesiems. Pažaidus, išdžiovinkite.
- Naudokite tik pridedamus PLAYMOBIL šaudmenis. Netaikyti į akis arba veidą.

SLO OPOZORILO!

- Uporabljajte samo v vodi, primerno plitvi za otroka in pod nadzorom odrasle osebe. Po igri naj se igrača posuši.
- Uporabljajte le priložene PLAYMOBIL-ove krogle. Ne merite v oči ali obraz.

SK UPOZORNENIE!

- Používať len vo vode, v ktorej dieťa dočiahne na dno, a pod dohľadom dospelej osoby. Po hre nechať vyschnúť.
- Používajte len náboje dodávané spolu so sadou PLAYMOBIL. Nemieriť do očí alebo do tváre.

PL OSTRZEŻENIE!

- Do używania jedynie w wodzie na głębokości, na której dziecko wyczuwa dno pod nogami oraz pod nadzorem osoby dorosłej. Po zabawie pozostaw do wyschnięcia.
- Stosować tylko załączone PLAYMOBIL - kule / pociski. Nie celować w oczy i twarz.

TR CY DİKKAT!

- Sadece denetim altında ve sadece alçak sularda kullanın. Oyundan sonra kurumaya bırakın.
- Sadece birlikte verilen PLAYMOBIL mermileri kullanınız. Göze veya yüze doğru tutmayınız.

GR CY Προειδοποίηση!

- Να χρησιμοποιείται μόνο σε νερά όπου πατώνει το παιδί και υπό την επίβλεψη ενήλικου. Μόλις τελειώσετε, αφήστε το παιχνίδι να στεγνώσει εντελώς.
- Να χρησιμοποιούνται αποκλειστικά τα βλήματα της PLAYMOBIL που περιέχονται στη συσκευασία. Μη μην γίνεται στόχευση στα μάτια ή στο πρόσωπο.

RO AVERTISMENT!

- A se utiliza numai acolo unde copilul poate sta în picioare în apă și este sub supraveghere. După joacă se lasă să se usuce.
- Se folosesc doar proiectilele incluse PLAYMOBIL. Nu se țintește în ochi sau în față.

BG Внимание!

- Да се използва само във вода, която е дълбока до нормалния ръст на детето, и под надзора на възрастен. След игра оставете да изсъхне.
- Използвайте само приложени PLAYMOBIL снаряди. Не насочвайте към очите и лицето.

HR UPOZORENJE!

- Koristiti samo u plitkoj vodi pod nadzorom odraslih. Poslije igranja pustiti da se osuši.
- Upotrijebiti samo od strane PLAYMOBIL-a isporučene projekte. Ne ciljati u oči ili lice.

CN 警告!

- 仅供儿童在齐胸以下的浅水中使用并且必须由成人监护。玩具玩后请拭干。
- 仅能使用PLAYMOBIL内置的弹射物。请勿瞄准眼睛或脸。(说明书上含有重要信息, 请保留备用。)

5

1



1 2 3
4 5 6 7

© 2018 geobra Brandstätter Stiftung & Co. KG No. 30800735
Brandstätterstraße 2-10, 90513 Zirndorf/Germany 04.18
Ghostbusters® & © 2018 CPT Holdings, Inc. All Rights Reserved

30 80 0735

4

3 2

1

30 06 7702

2

7 6

30 06 7712

30 06 7722

30 23 1952

Detailed description: This diagram shows the assembly of a control console. Part 1 is a blue base (30 06 7702) with a red and yellow warning label (30 80 0735) being attached. Part 2 shows a blue control panel (30 06 7712) being placed on top of the base. A yellow cable (30 23 1952) is connected to the panel. A yellow and black striped warning label (30 06 7722) is also shown. A parts list at the top identifies components 1 through 7.



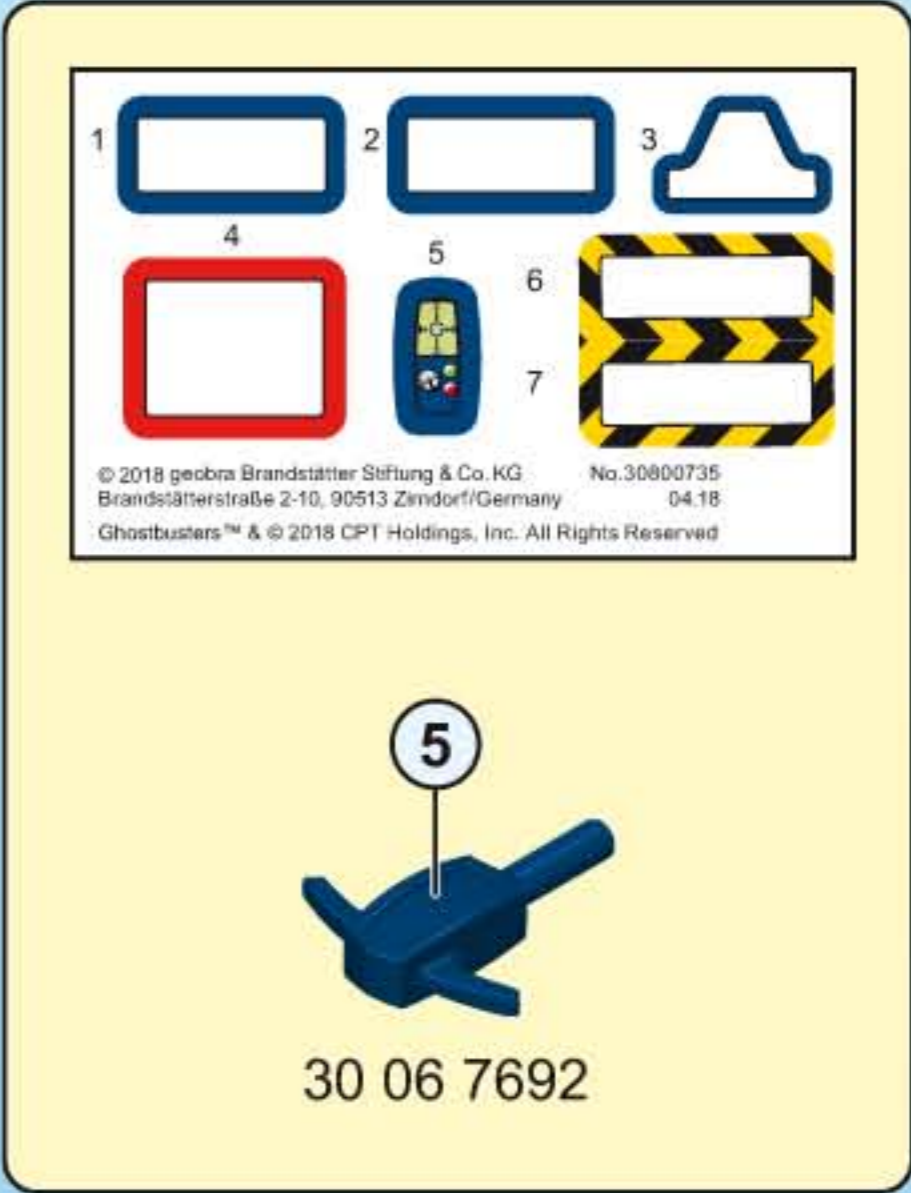
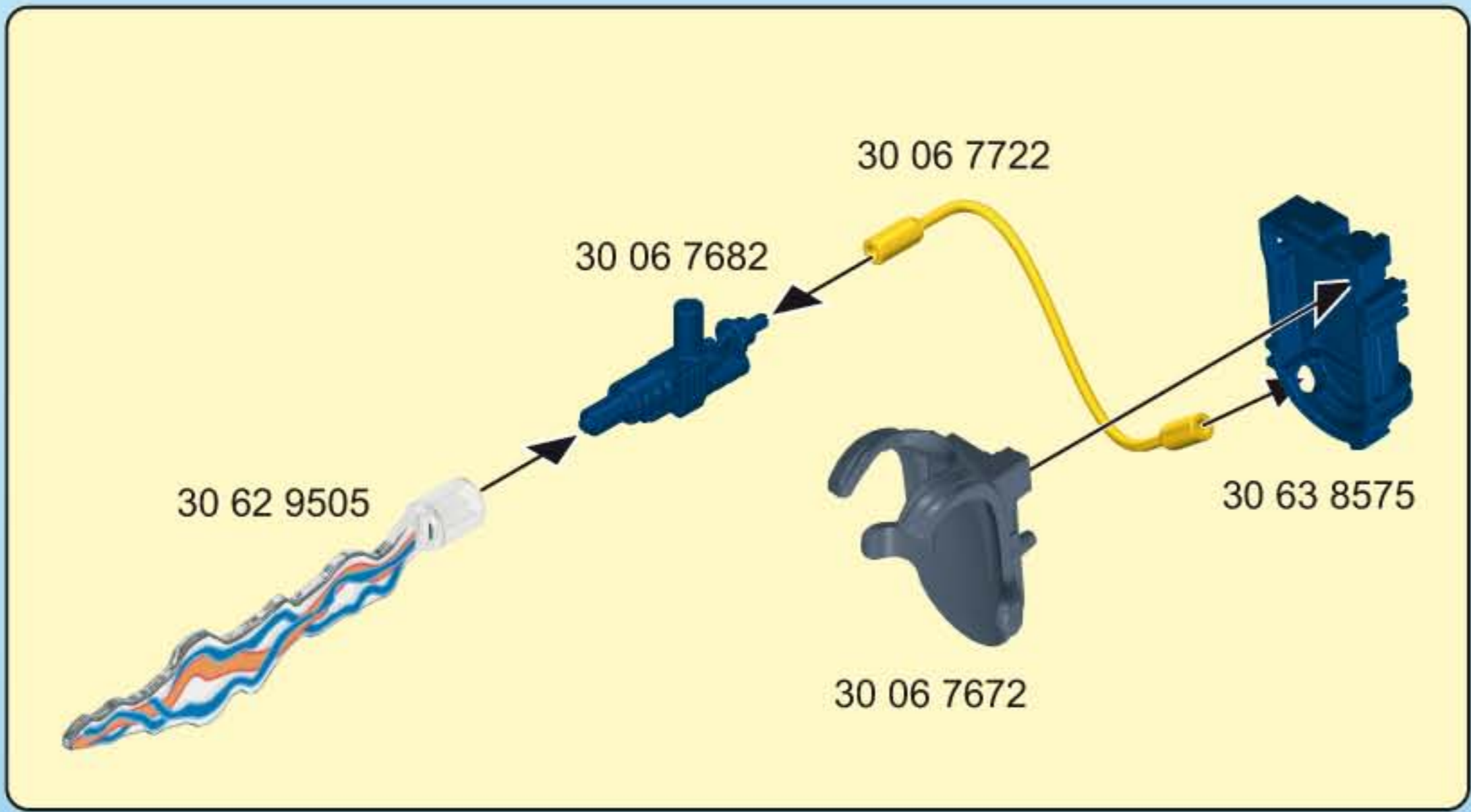

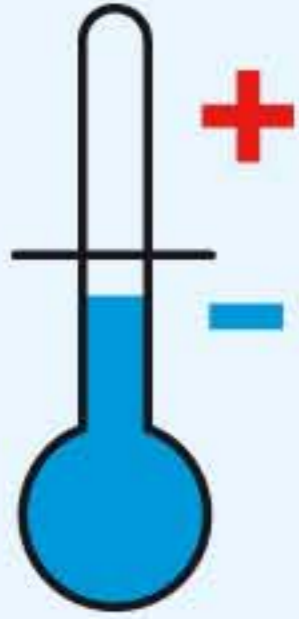

30 07 1132

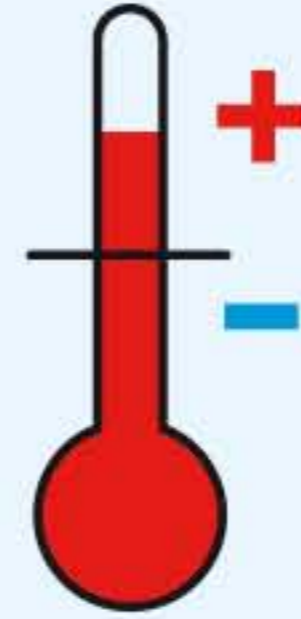

Serviceadressen finden Sie in allen Playmobil-Prospekten

Addresses of Customer Service Departments are shown in all Playmobil catalogues

L'adresse du service consommateurs est indiquée dans tous les catalogues Playmobil

Troverete gli indirizzi dei centri di assistenza in tutti i cataloghi Playmobil

In alle PLAYMOBIL catalogi vindt u het adres van onze klantendienst.

Las Direcciones de los Departamentos de Servicio al Consumidor se encuentran en todos los catálogos Playmobil

Η διεύθυνση του Γραφείου Εξυπηρέτησης Καταναλωτών PLAYMOBIL βρίσκεται σε όλους τους καταλόγους PLAYMOBIL.

pronounce: plāy-mō-bēēl

Abbildungen können vom Original abweichen. / Product may differ from image shown.
Les illustrations peuvent différer de l'original. / Afbeeldingen kunnen verschillen van het werkelijke artikel.



© 2018 geobra Brandstätter Stiftung & Co.KG
Brandstätterstr. 2-10
90513 Zirndorf, Germany.
No. 30 80 3105 11.17

www.playmobil.com