

playmobil myLife



WARNING:
CHOKING HAZARD

Contains a small ball and small parts.
Not for children under 3 years.



AVERTISSEMENT:
RISQUE DE SUFFOCATION.

Contient une petite balle et de petites pièces.
Ne convient pas aux enfants de moins de 3 ans.

Bauanleitung | Assembly instruction |
Instructions de construction | Instrucciones de construcción

72057

1

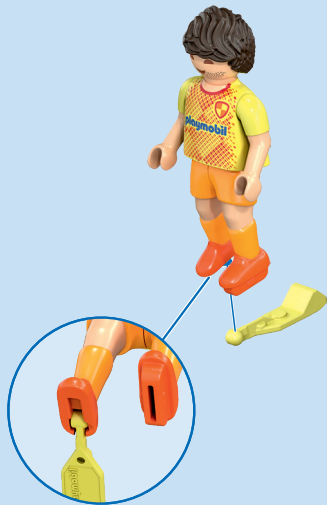

2

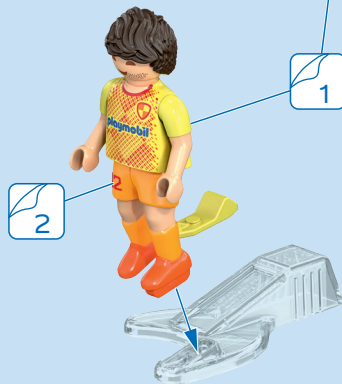

© 2026 geobra Brandstätter Stiftung & Co. KG
 Brandstätterstraße 2-10 No.30804007
 90513 Zirndorf/Germany 09.25

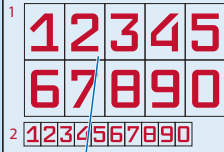

1

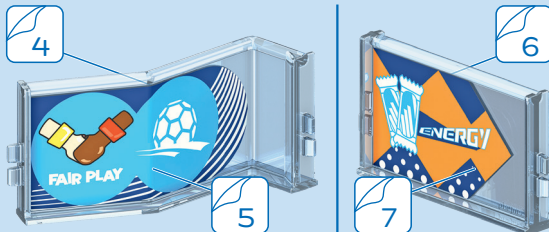
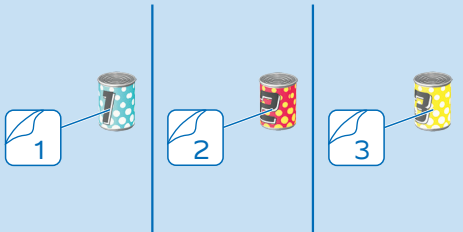
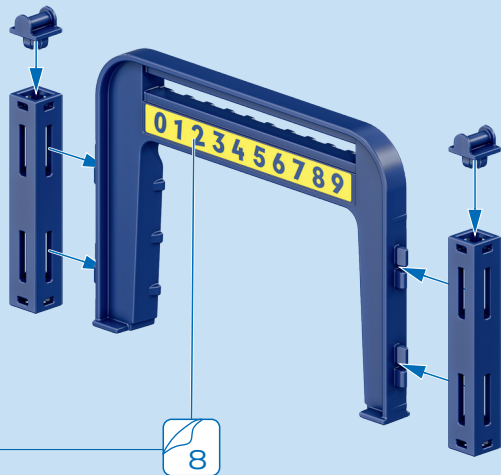

3

2

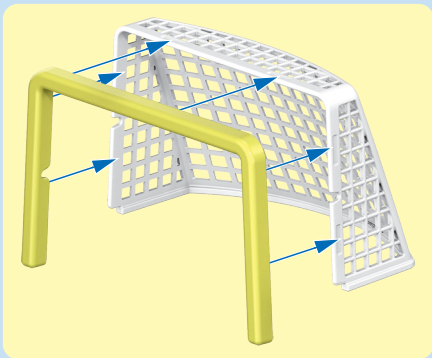

3



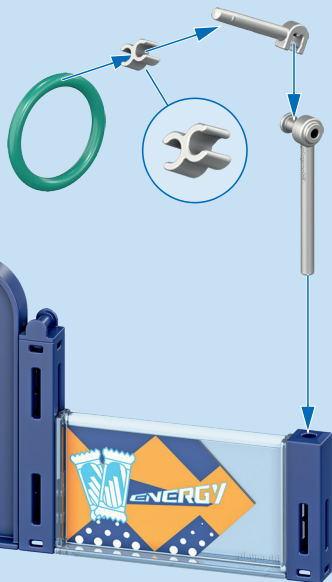

DE AT CH LU BE ACHTUNG!
Nicht auf Augen oder Gesicht zielen.

US GB CA MT IE WARNING!
Do not aim at eyes or face.

FR CA BE LU CH ATTENTION!
Ne pas viser les yeux ou le visage

ES MX ¡ADVERTENCIA!
No apuntar a los ojos ni a la cara.

NL BE WAARSCHUWING!
Niet op ogen of gezicht richten.

IT CH AVVERTENZA!
Non mirare agli occhi o al viso.

PT ATENÇÃO!
Não apontar para os olhos ou face.

DK ADVARSEL!
Sigt ikke mod øjne eller ansigt.

NO ADVARSEL!
Sikt ikke på ansikt eller øyne.

SE FI VARNING!
Sikta inte mot ögon eller ansikte.

FI VAROITUS!
Ei saa kohdistaa suoraan silmiin tai kasvoihin.

HU FIGYELMEZTETÉS.
Tilos szemre vagy arcra célozni.

CZ UPOZORNĚNÍ!
Nemířte na oči nebo na obličej!

EE HOIATUS!
Ära sihi silmadesse ega näkku.

LV BRĪDINĀJUMS!
Nevērst pret acīm vai seju.

LT ĮSPĖJIMAS!
Netaikyti į akis arba veidą.

SI OPOZORILO!
Ne merite v oči ali obraz.

SK UPOZORNENIE!
Nemieriť do očí alebo do tváre.

PL OSTRZEŻENIE!
Nie celować w oczy i twarz.

TR CY DİKKAT!
Göze veya yüze doğru tutmayınız.

GR CY Προειδοποίηση!
Μη μην γίνεται στόχευση στα μάτια ή στο πρόσωπο.

RO AVERTISMENT!
Nu se țintește în ochi sau în față.

BG Внимание!
Не насочвайте към очите и лицето.

HR UPOZORENJE!
Ne ciljati u oči ili lice.

RU Внимание!
Не цельтесь в глаза или лицо.

CN 警告!
请勿瞄准眼睛或脸。

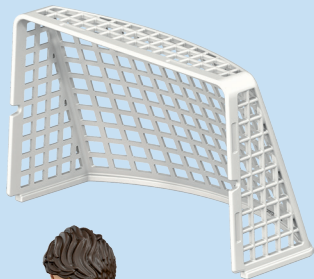

30 06 9215

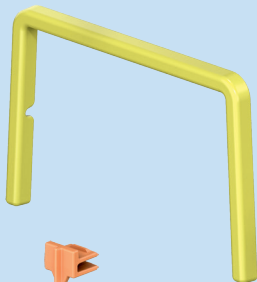

30 21 6604



30 21 6634



30 05 4784



2x 30 21 6584



30 00 9615

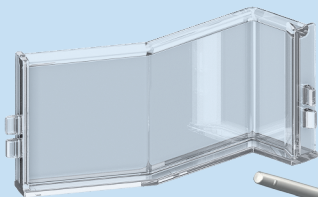

30 05 8815

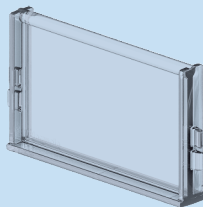

30 07 0385



30 09 2405



2x 30 21 6664



30 05 9412

30 21 6994

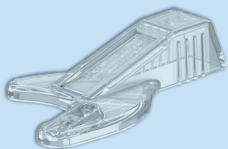

30 03 9264



30 21 6734



30 64 9249



30 21 7024



30 05 9402



30 21 7014



2x 30 21 6554



3x 30 23 1310



2x 30 09 6610



3x 30 22 6530



30 27 1060



30 04 8472



30 21 7172



30 80 4007



30 80 3997

Serviceadressen finden Sie in allen PLAYMOBIL-Prospekten

Addresses of Customer Service Departments are shown in all PLAYMOBIL catalogues

L'adresse du service consommateurs est indiquée dans tous les catalogues PLAYMOBIL

Troverete gli indirizzi dei centri assistenza in tutti i cataloghi PLAYMOBIL

In alle PLAYMOBIL catalogi vindt u het adres van onze klantendienst.

Las Direcciones de los Departamentos de Servicio al Consumidor se encuentran en todos los catálogos PLAYMOBIL

Η διεύθυνση του Γραφείου Εξυπηρέτησης Καταναλωτών PLAYMOBIL βρίσκεται σε όλους τους καταλόγους PLAYMOBIL.

pronounced: plāymō-bēēl

Abbildungen können vom Original abweichen. Product may differ from image shown. Les illustrations peuvent différer de l'original. Las ilustraciones pueden diferir del original. Afbeeldingen kunnen verschillen van het werkelijke artikel.

Wichtige Unterlagen, bitte sorgfältig aufbewahren! Important: Please keep these instructions for future reference! Documents importants, à conserver soigneusement ! ¡Por favor, guarde estas instrucciones para el futuro! Belangrijke documenten, bewaar deze zorgvuldig!

UK Importer: Playmobil UK Ltd. Regency House 1 Miles Gray Road Basildon • Essex SS14 • 3RE • UK

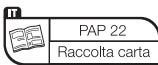

ASSOCIATION



MAGASIN



LIVRAISON



DÉCHÈTERIE



PAP



100%

©2025 geobra Brandstätter Stiftung & Co. KG • Brandstätterstr. 2-10 • 90513 Zirndorf, Germany No. 30 90 6397 10.25

Adresses sur quefairedemesdechets.fr