

playmobil®

myLife



71509



SCAN MICH  
SCAN ME  
SCANNEZ-MOI  
ESCANÉAME



\*TINY HOUSE PRODUKTE  
\*TINY HOUSE PRODUCTS  
\*GAMME TINY HOUSE  
\*PRODUCTOS DE LA CASA PEQUEÑA

\*Im Schnitt zu über 80% mit recycelten und biobasierten Materialien.

\*With more than 80% recycled and bio based materials on average.

\*Avec plus de 80% de matériaux recyclés et biosourcés en moyenne.

\*Con una media de más del 80% de materiales reciclados y biodegradables.

**HINWEIS**  
Note notice  
Atención



Aufbauen leicht gemacht mit nummerierten Tüten.  
Viel Spaß mit deinem neuen PLAYMOBIL-Spielzeug!

Set-up made easy with numbered bags.  
Have fun with your new PLAYMOBIL toy!

Simplicité de montage avec les sachets numérotés.  
Amuse-toi avec tes nouveaux PLAYMOBIL!

El montaje es más fácil con las bolsas numeradas.  
¡Diviértete con tu nuevo juguete de PLAYMOBIL!





# WARNING: CHOKING HAZARD

Contains a small ball and small parts.  
Not for children under 3 years.

"Ne concerne que les USA"

Wichtige Unterlagen, bitte sorgfältig aufbewahren!  
Important: Please keep these instructions for future reference!  
Documents importants, à conserver soigneusement!  
¡Por favor, guarde estas instrucciones para el futuro!  
Belangrijke documenten, bewaar deze zorgvuldig!

Abbildungen können vom Original abweichen.  
Product may differ from image shown.  
Les illustrations peuvent différer de l'original.  
Las ilustraciones pueden diferir del original.  
Afbeeldingen kunnen verschillen van het werkelijke artikel.

Serviceadressen finden Sie in allen  
PLAYMOBIL-Prospekten

Addresses of Customer Service Depart-  
ments are shown in all PLAYMOBIL  
catalogues

L'adresse du service consommateurs  
est indiquée dans tous les catalogues  
PLAYMOBIL

Troverete gli indirizzi dei centri di  
assistenza in tutti i cataloghi PLAYMOBIL

In alle PLAYMOBIL catalogi vindt u  
het adres van onze klantendienst.

Las Direcciones de los Departamentos  
de Servicio al Consumidor se encuentran  
en todos los catálogos PLAYMOBIL

Η διεύθυνση του Γραφείου Εξυπηρέτησης  
Καταναλωτών PLAYMOBIL βρίσκεται σε  
όλους τους καταλόγους PLAYMOBIL.

pronounced: plāy-mō-bēēl

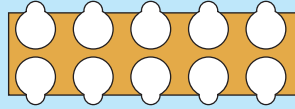

30 80 9313



30 82 1936



30 04 2265



30 04 2225

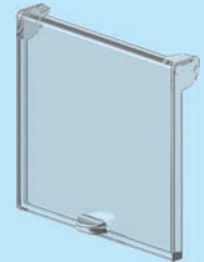

30 04 2205

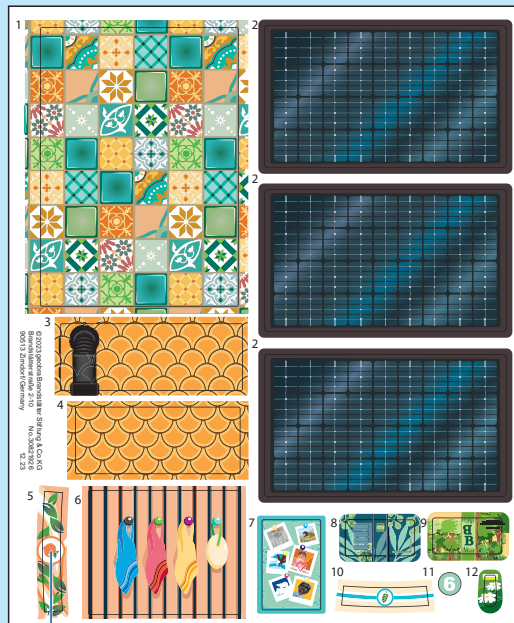

30 82 1926



30 51 5573



30 65 8822



10x 30 07 3784



7x 30 07 3814



5x 30 04 6275

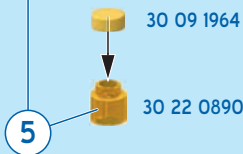

30 09 1964

30 22 0890



3x 30 04 2685



30 04 2655



30 04 2645

5



30 00 5925



30 14 8452



30 10 5800

30 04 2155

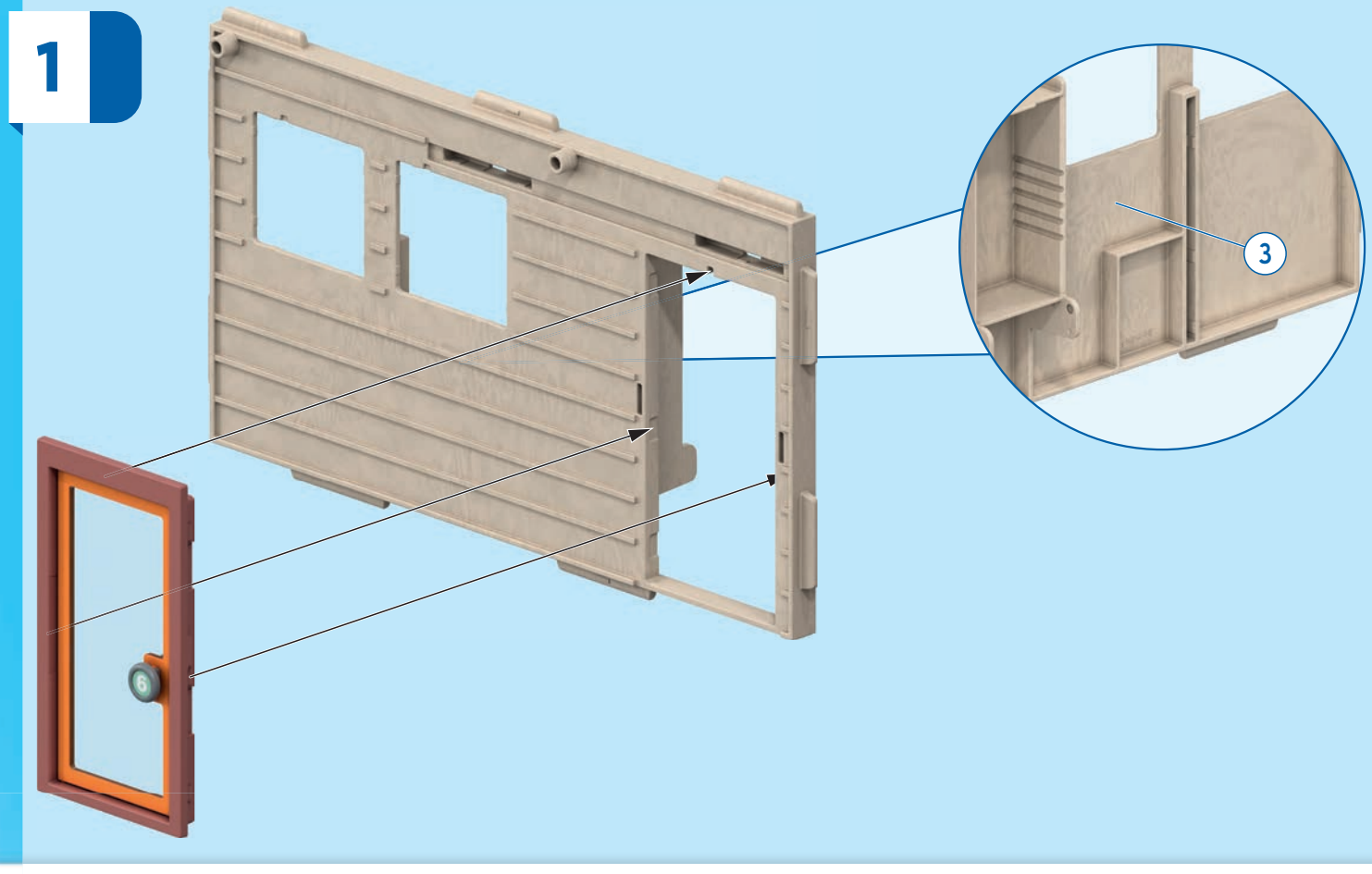
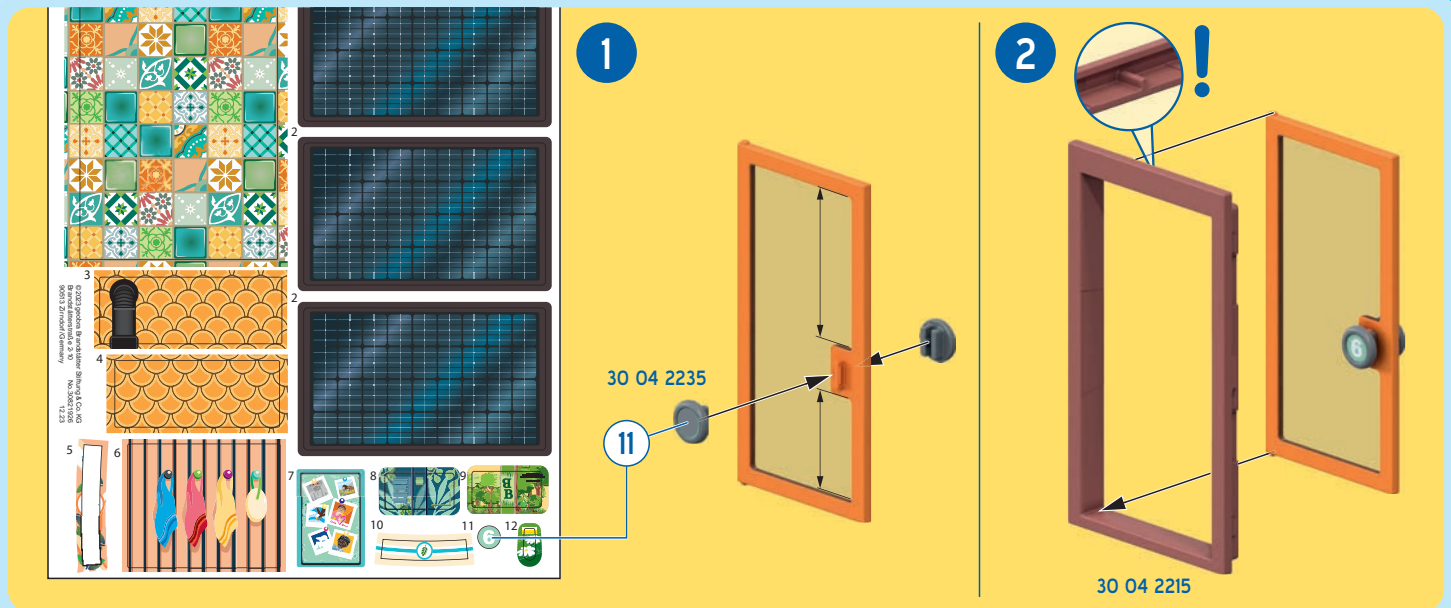
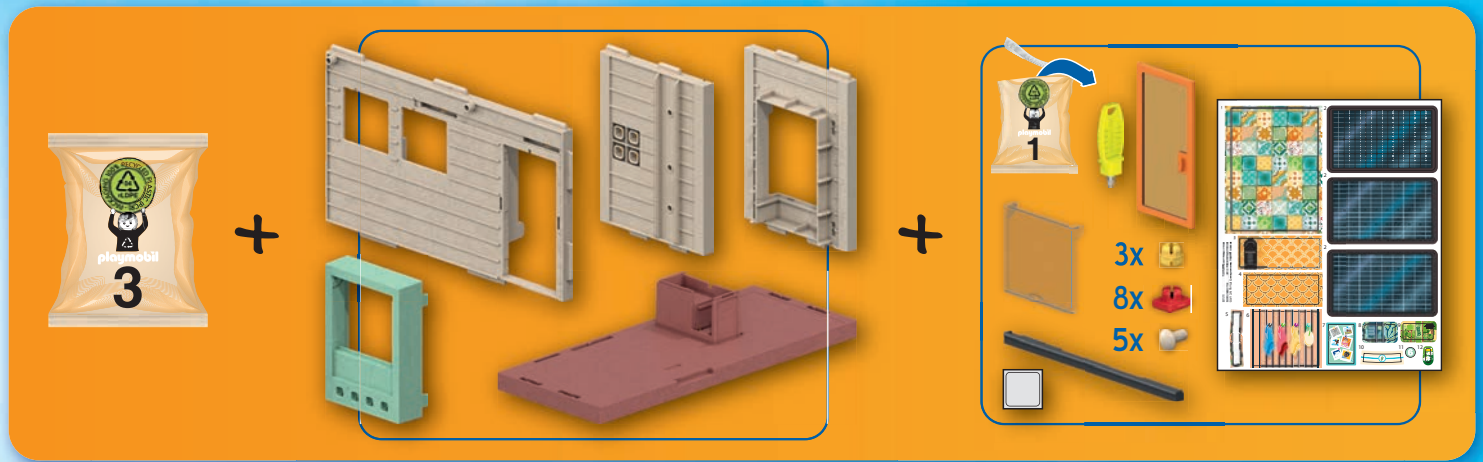

2

2x

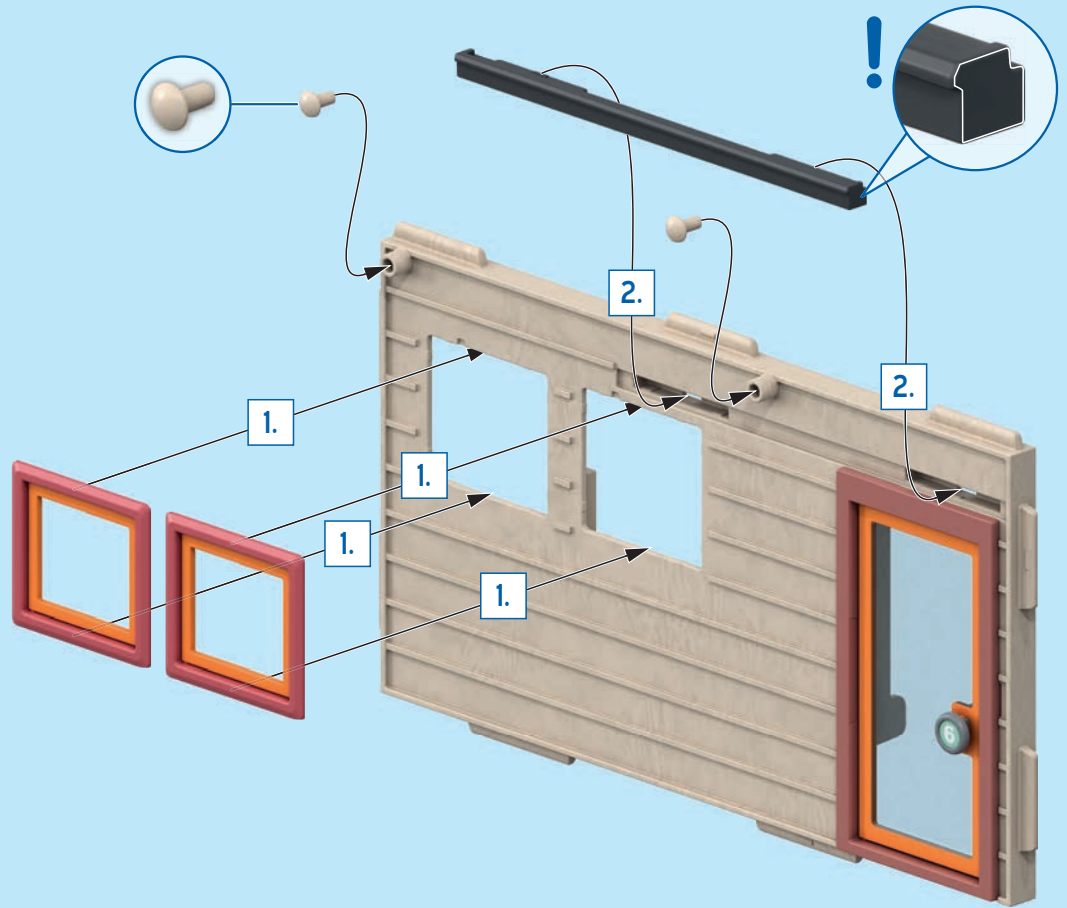
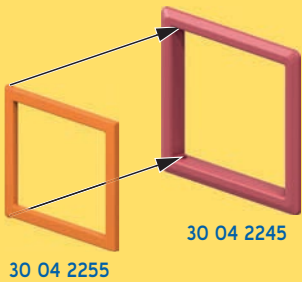

3

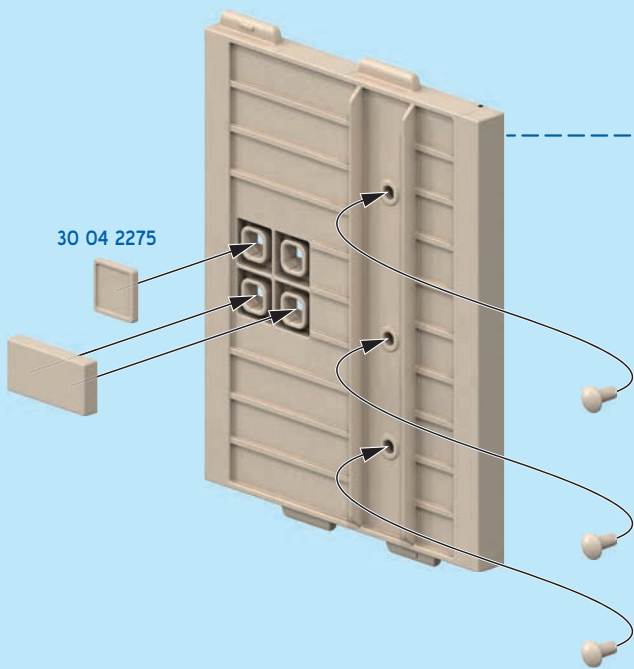

4

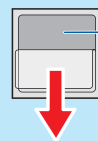

5

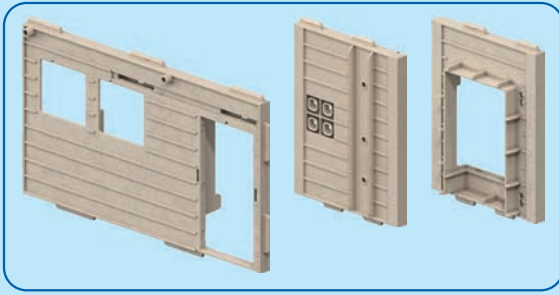

30 51 5743

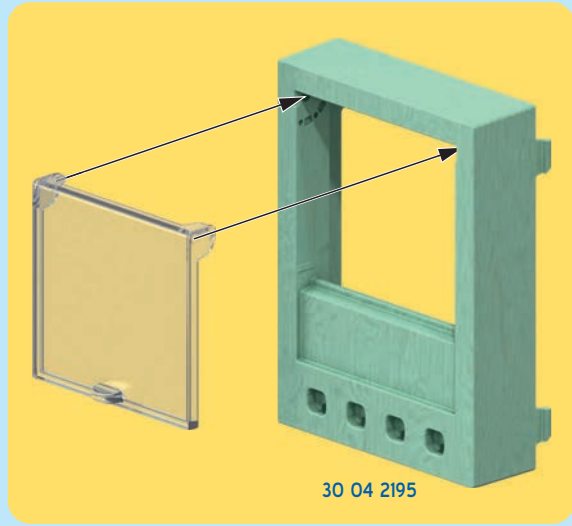

30 04 2195

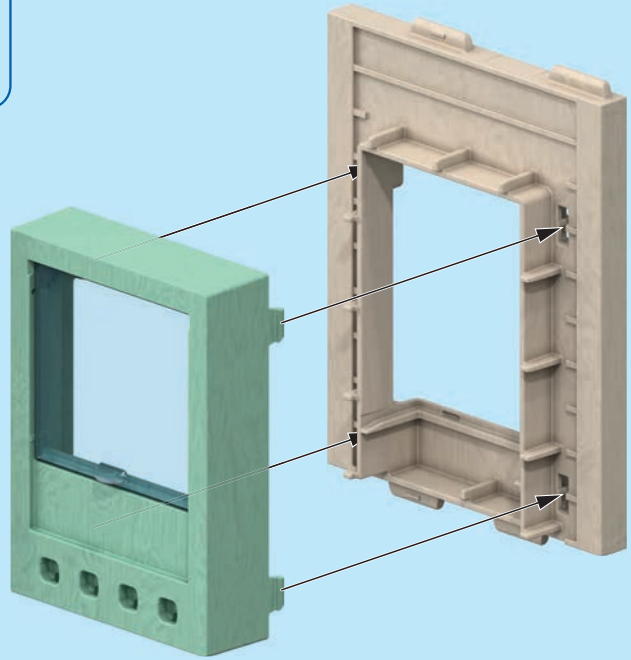

6

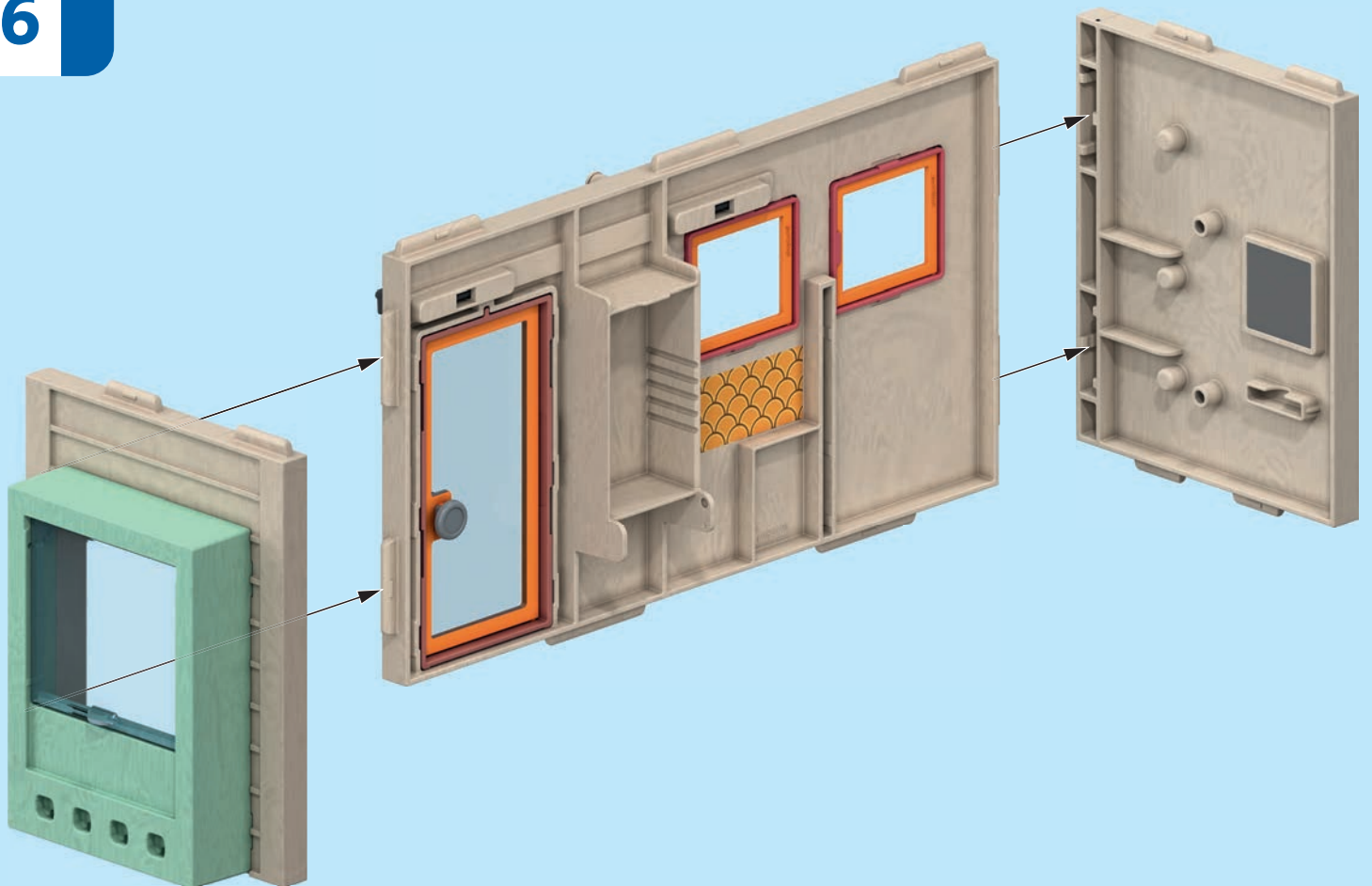

7

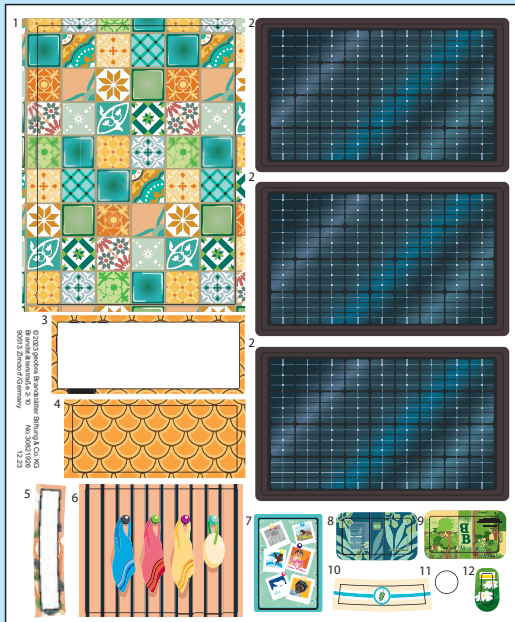

30 04 2185

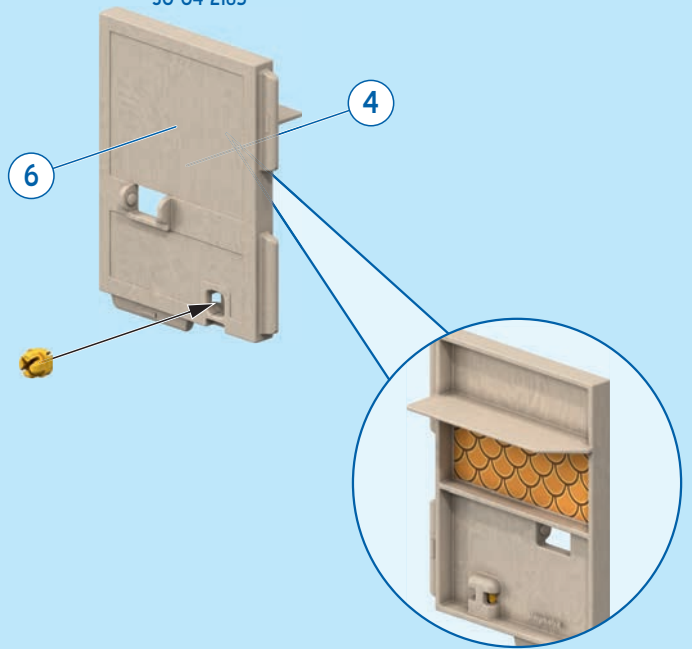

8

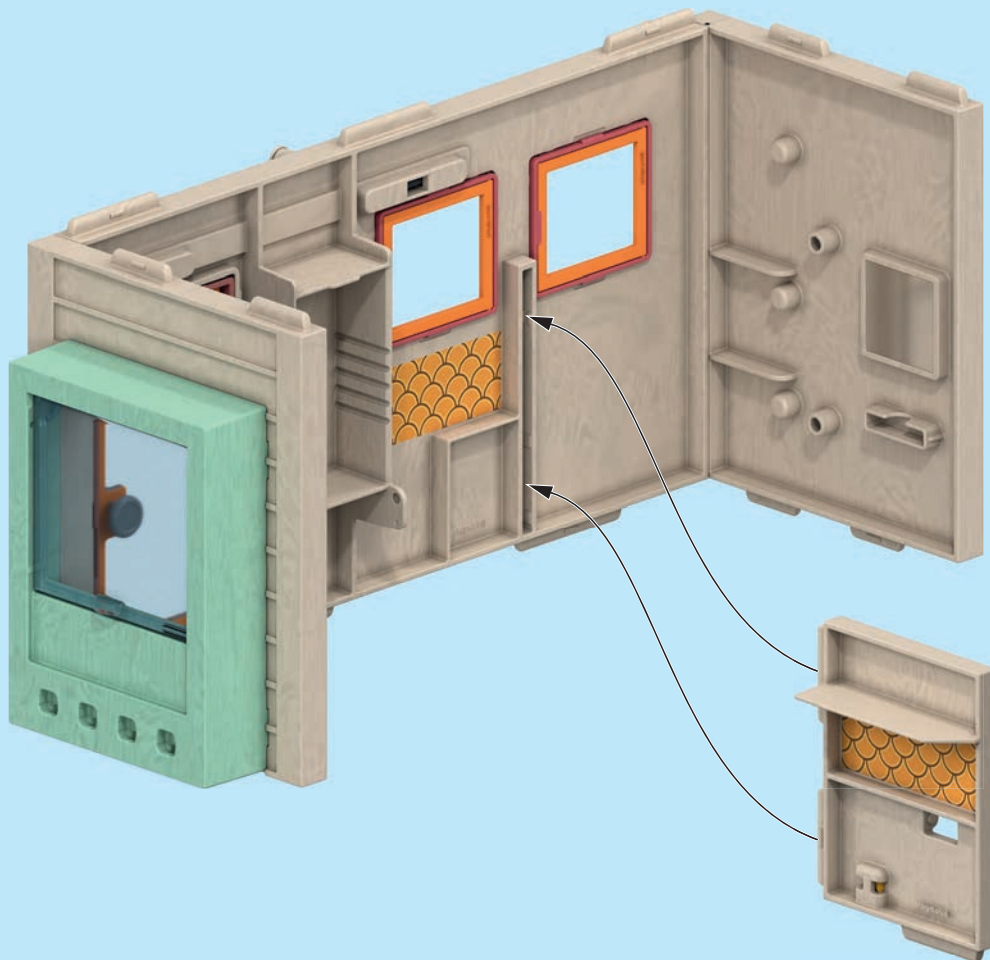

9

4x

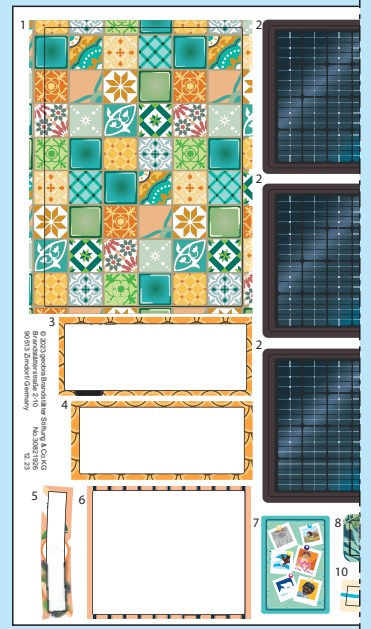
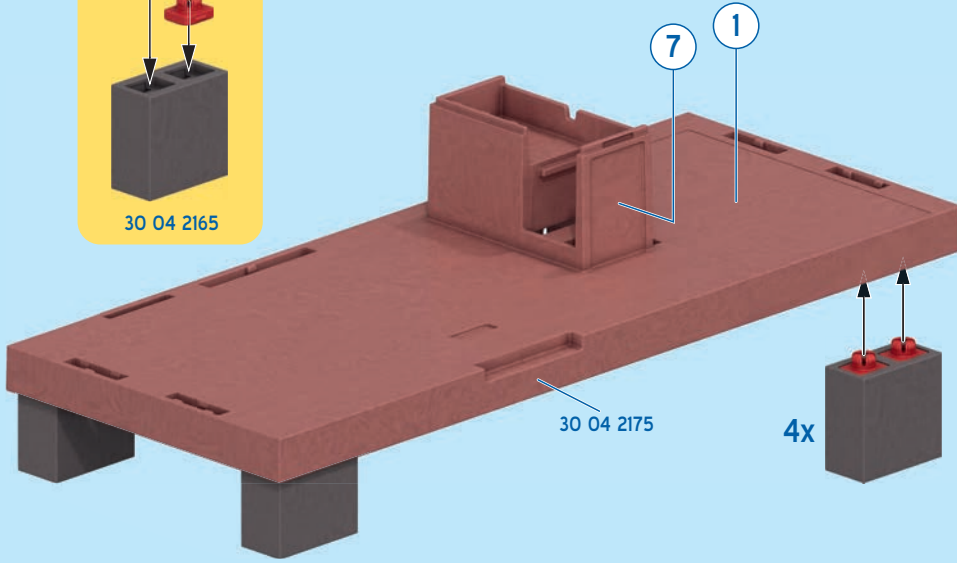
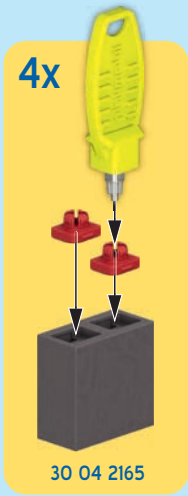

10

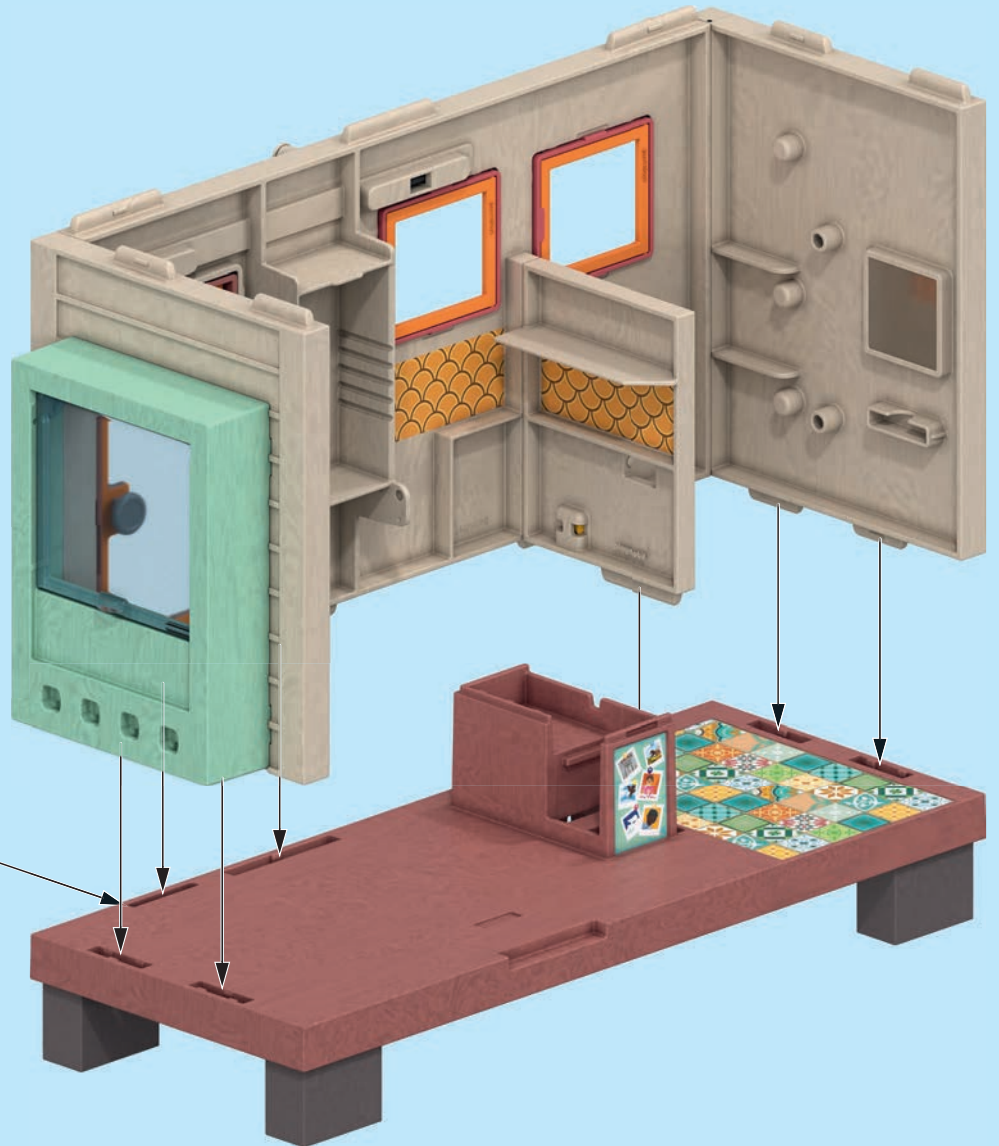
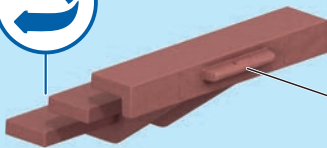
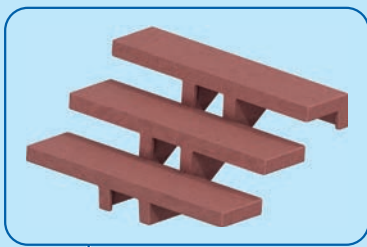





+



+

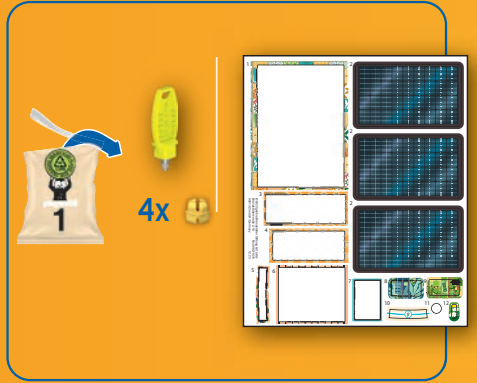

1

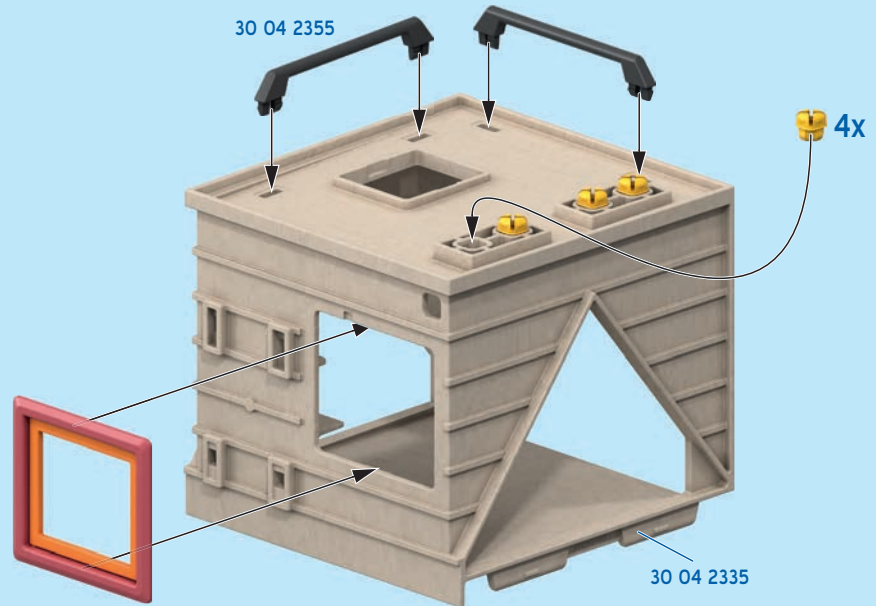
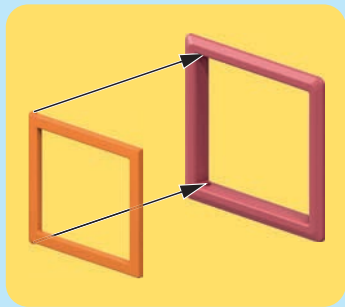

2

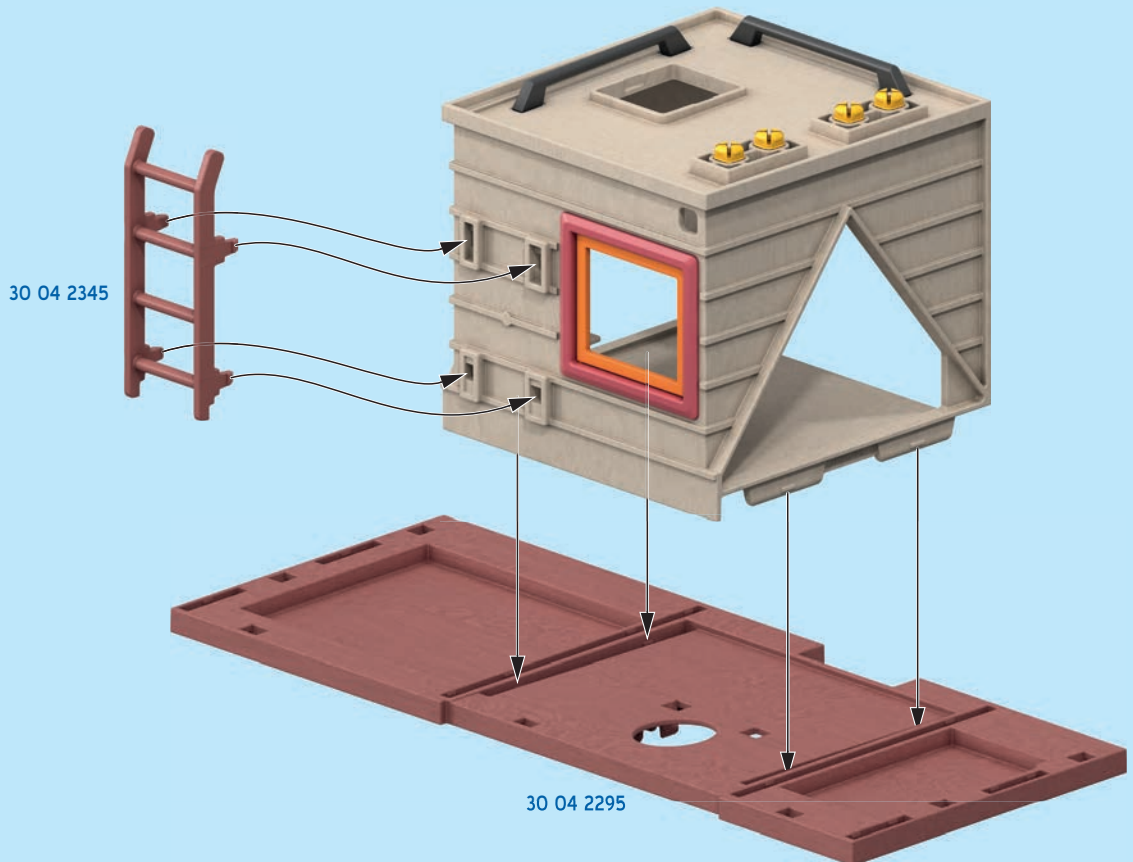

30 04 2325

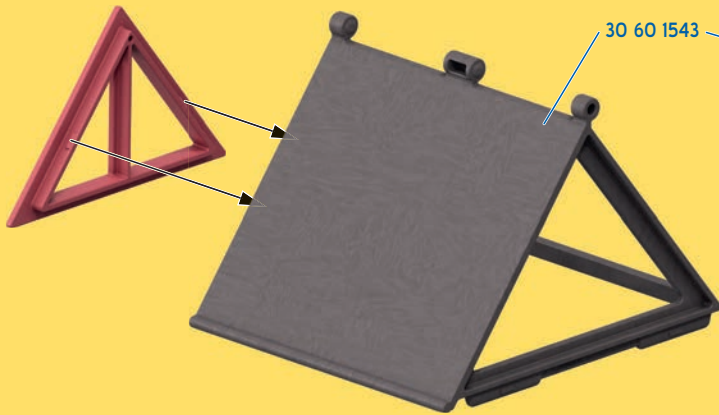

30 60 1543

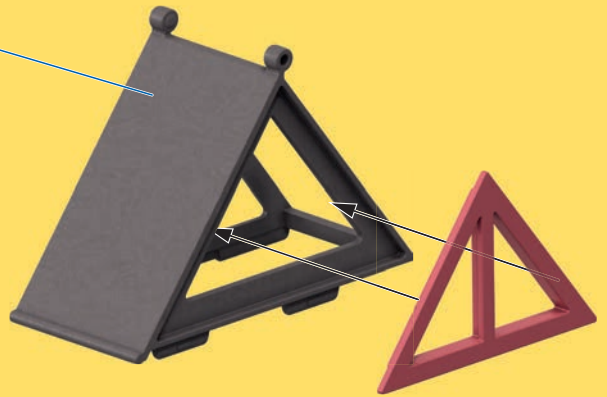

3

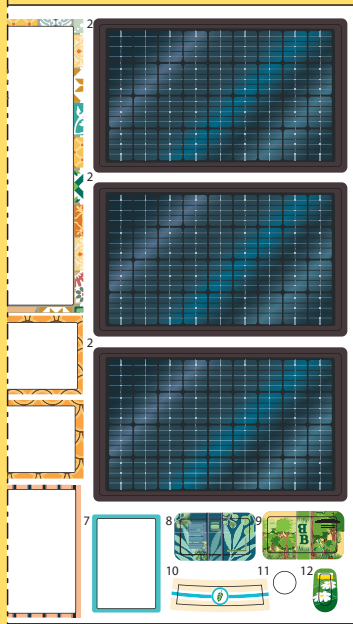

3x

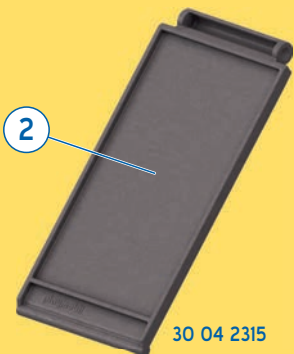

30 04 2315

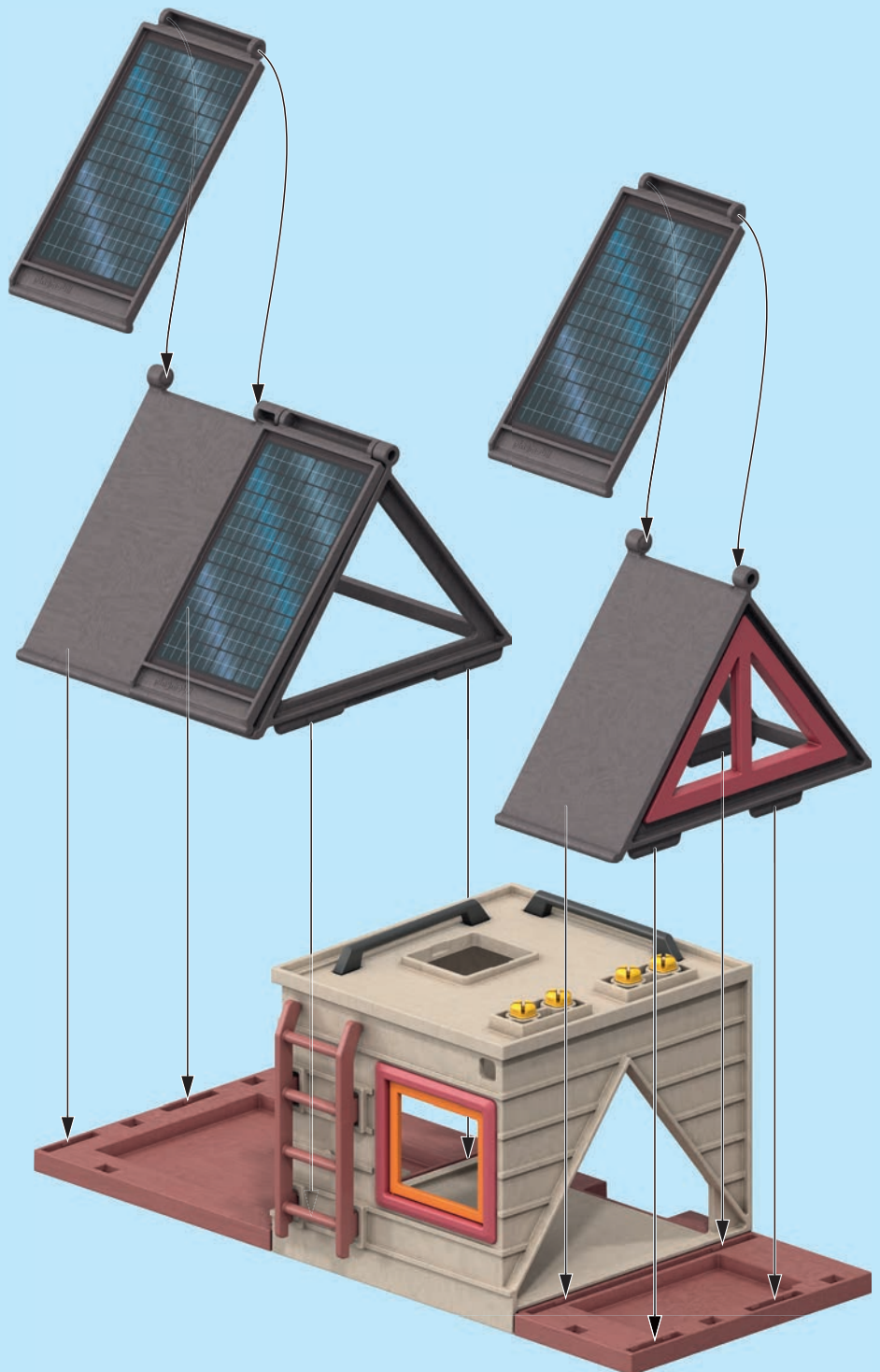



+



+



+



1

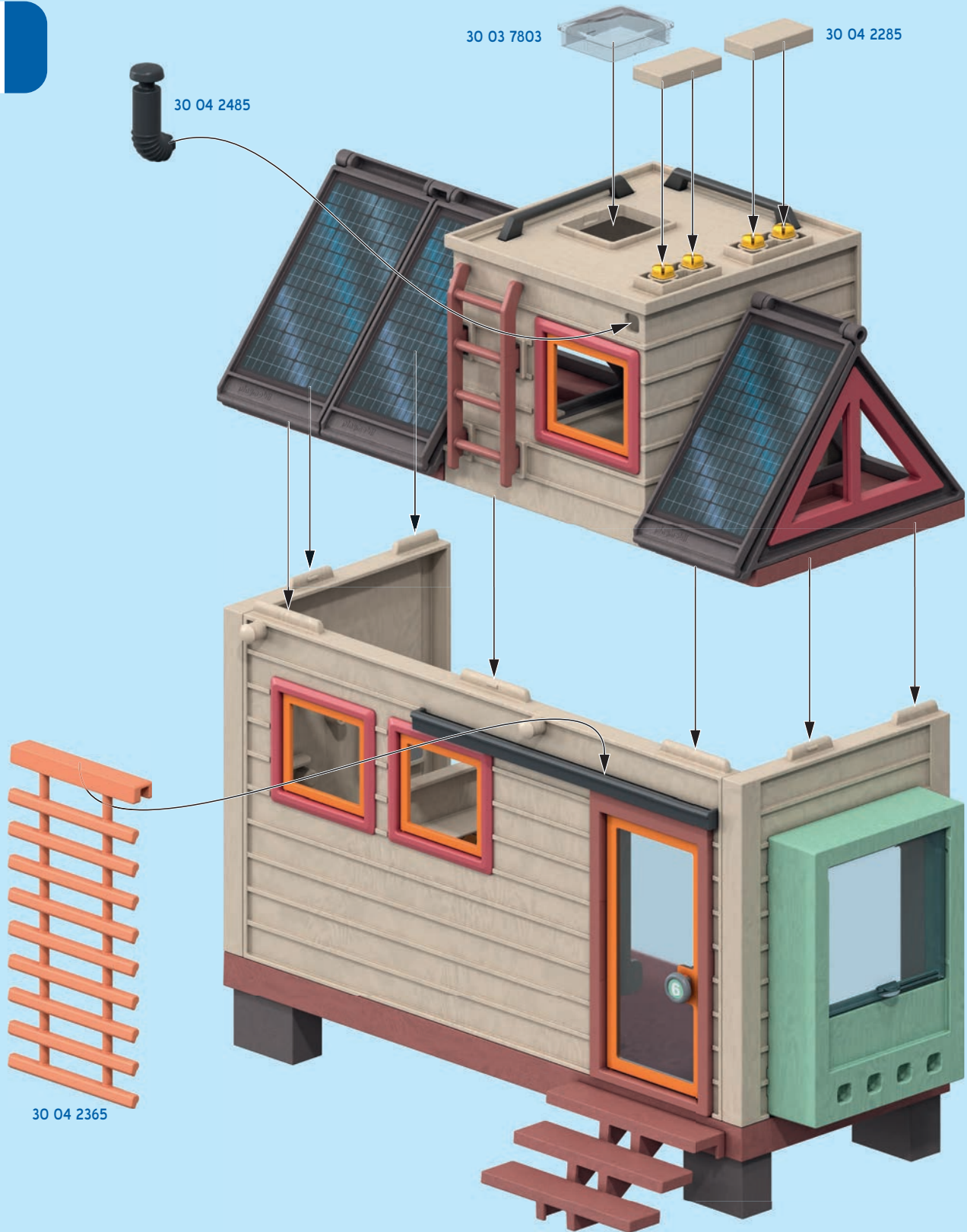

1

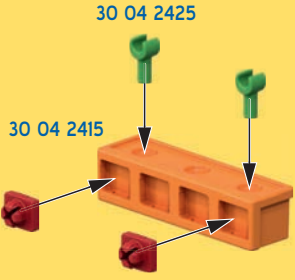

2



1



2



30 07 7984



2



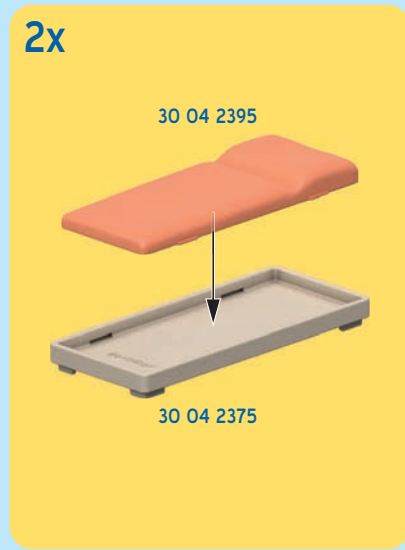
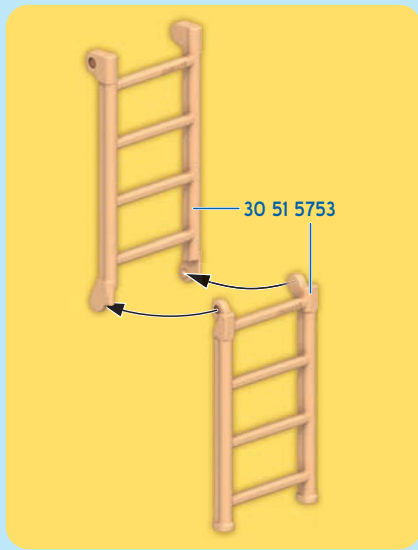

**3**





+



1

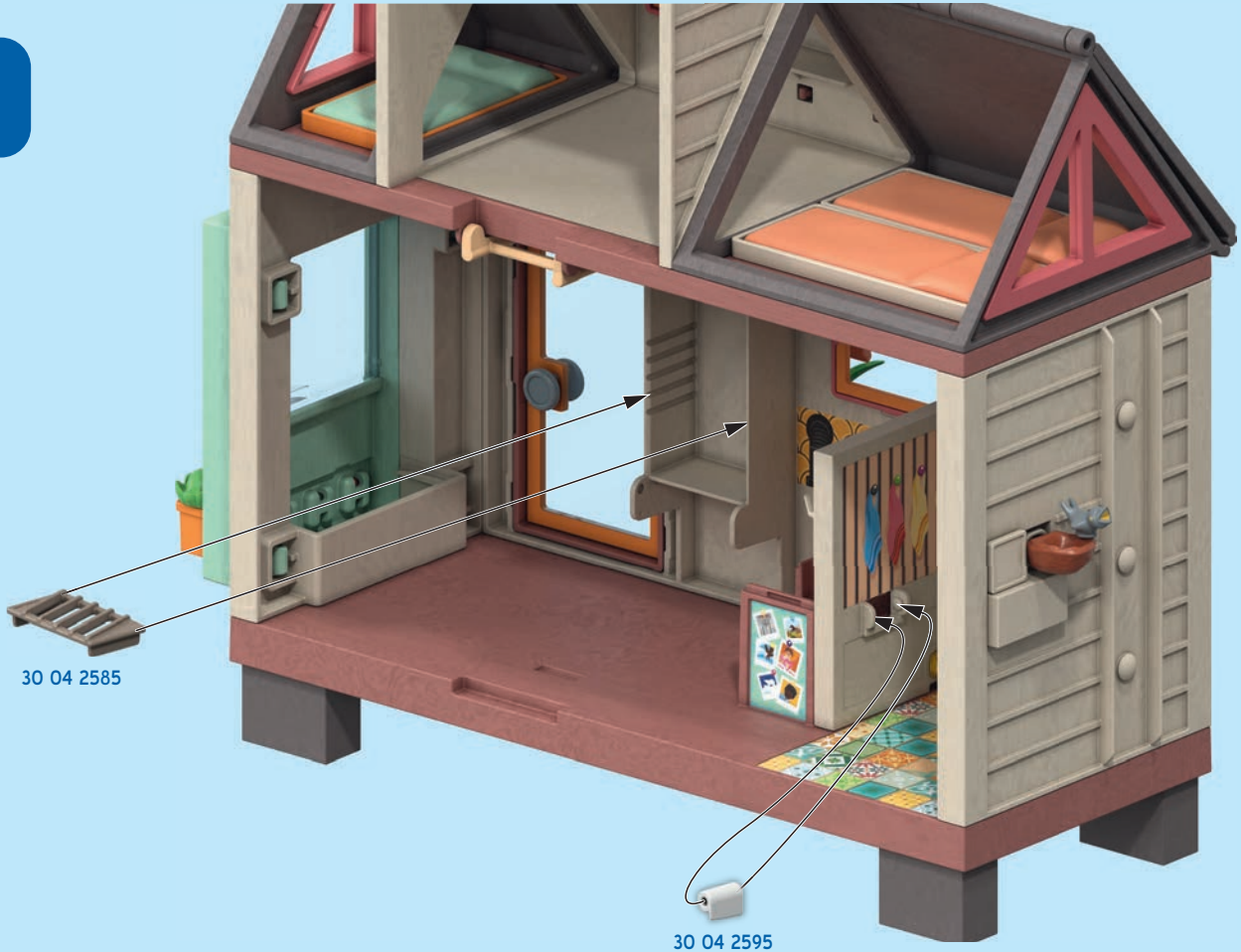

30 04 2585

30 04 2595

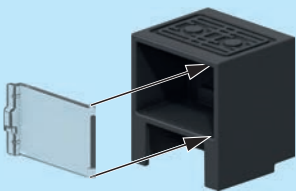

30 04 2535

30 04 2525

30 22 4983

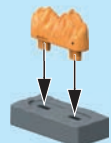

30 04 2745

30 22 6223



30 20 4184

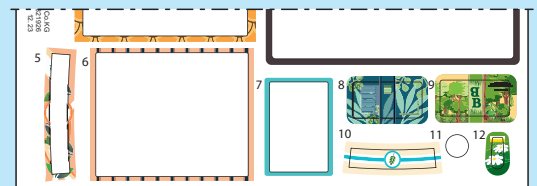

30 04 2665

30 04 2675

30 04 2695



9



8



12



30 04 2605



3x 30 24 2943

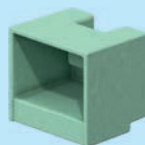

30 04 2515



30 05 0790



30 03 4752



30 09 8974



30 04 2735



+



+

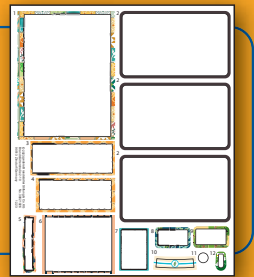

+



1

30 04 2505

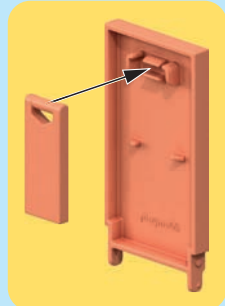

30 60 1553

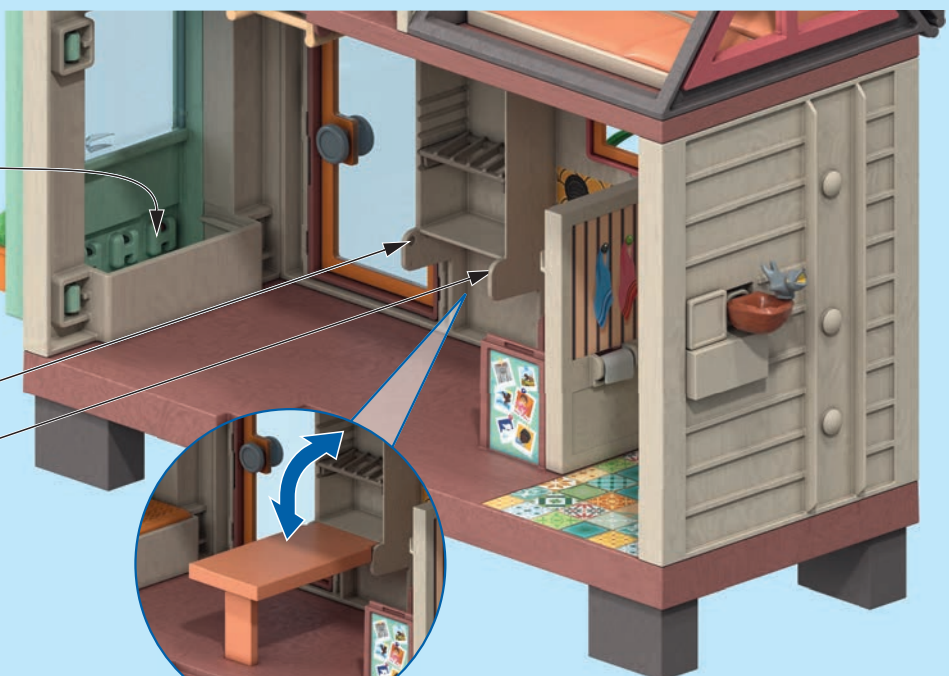
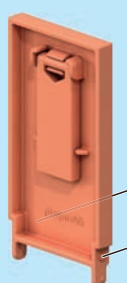

2

30 04 2575



30 04 2565

30 20 3964



30 04 2555

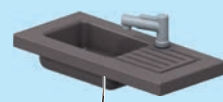

30 60 1563

3



30 04 2615



1.

1.

2.

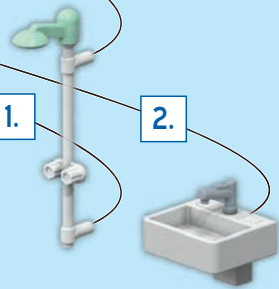

4

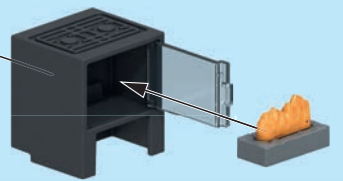
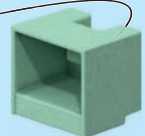
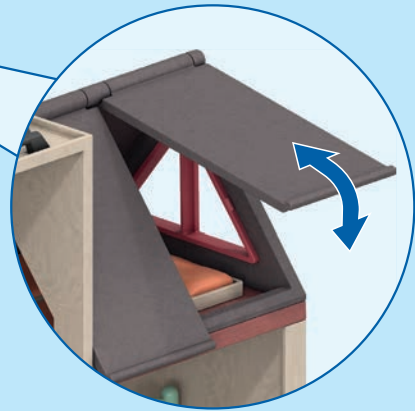



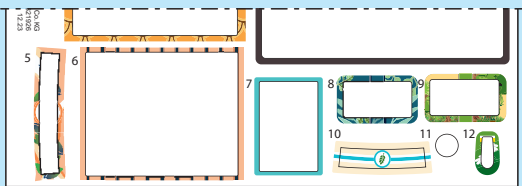

10  
30 04 2755



30 04 2635



30 04 2705



30 04 2715



30 20 4254



4x 30 04 2725

71509 + 70771



1.

3.

2.

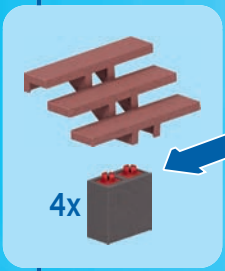

4x

1



2

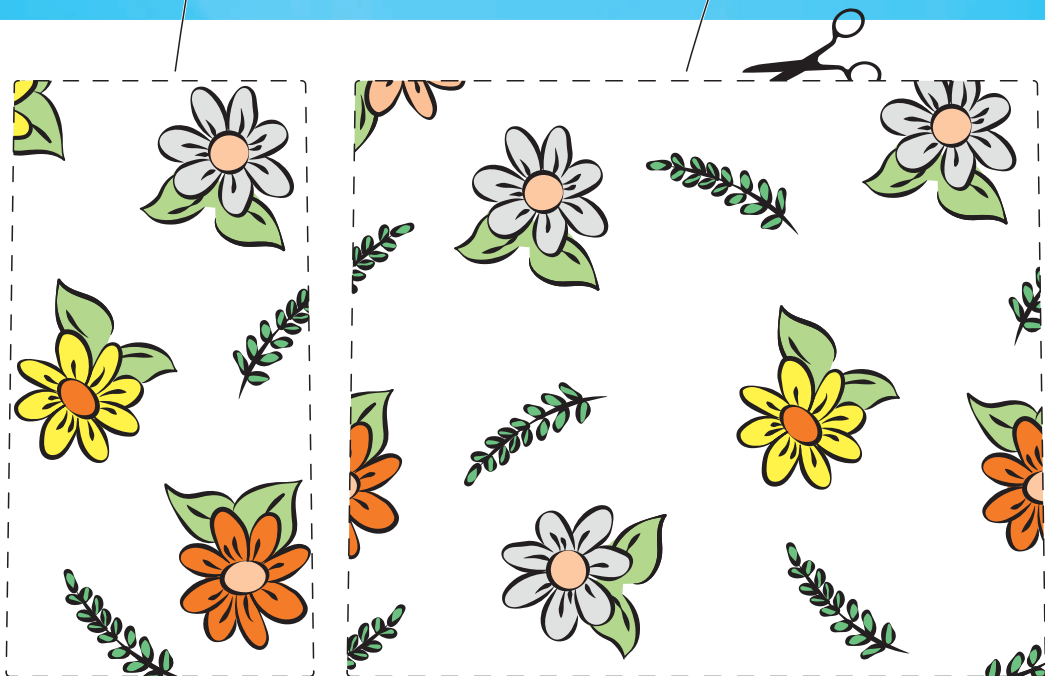

**DE** **AT** **CH** **LU** **BE** Zu-/Ausschneiden mit einer Kinderscherer unter Aufsicht von Erwachsenen.  
**US** **GB** **CA** **MT** **IE** Cut or out using children's scissors under adult supervision.  
**FR** **CA** **BE** **LU** **CH** Procéder au découpage/à la mise à longueur avec des ciseaux pour enfants sous la surveillance d'adultes.  
**ES** **MX** Cortar / recortar con tijeras para niños, bajo la supervisión de adultos.  
**NL** **BE** Knippen/uitknippen met een kinderschaar onder toezicht van volwassenen.

**IT** **CH** Tagliare/ritagliare con una forbice per bambini sotto la sorveglianza di un adulto.  
**PT** Realizar cortes com uma tesoura para crianças sob vigilância de um adulto.  
**DK** Klippes til og klippes ud med en børnesaks under opsyn af en voksen.  
**NO** Klippes ut med børnesaks under tilsyn av en voksen.  
**SE** **FI** Barn får endast klippa till/klippa ut något med barnsaxen under uppsikt av en vuxen.  
**FI** Leikataan lasten saksilla aikuisten valvonnassa.

**HU** Ki-levágása gyermekkorlál, felnőt felügyelete mellett iörsnik.  
**CZ** Používání dětských nůžek na střihání / vystřihování musí být pod dohledem dospělé osoby.  
**EE** Väijälõikamine lastekõõrdega on lubatud üksnes täiskasvanute järelevalve all.  
**LV** Izgriezt att bērnu šķērēm pieaugušo uzraudzībā.  
**LT** Kerpani vaikiškomis žirkėmis vaikų turi prižiūrėti suaugęs asmuo.  
**SI** Prirezovanje/izrezovanje s škarjami za otroke pod nadzorom odraslih.  
**SK** Používání dětských nožnic na strihanie / vystřihovanie musí byť pod dohľadom dospelého.  
**PL** Do wycinania nożyczkami dla dzieci pod kontrolą osób dorosłych.

**TR** **CY** Çocuk makasıyla bir yetişkinin denetimi altında kesilmelidir.  
**GR** **CY** Köşete je παιδικό ψαλίδι υπό την επίβλεψη ενήλικου.  
**RO** Decuparea/ajustarea lungimii se face cu un foarfece pentru copii sub supravegherea unor adulti.  
**BG** Рязането/изрязването с детска ножница да става под надзора на възрастних.  
**HR** Rezanje/izrezivanje škarama pod nadzorom odraslih.  
**CN** 在成年人的照看下用儿童剪刀裁切 / 剪下。

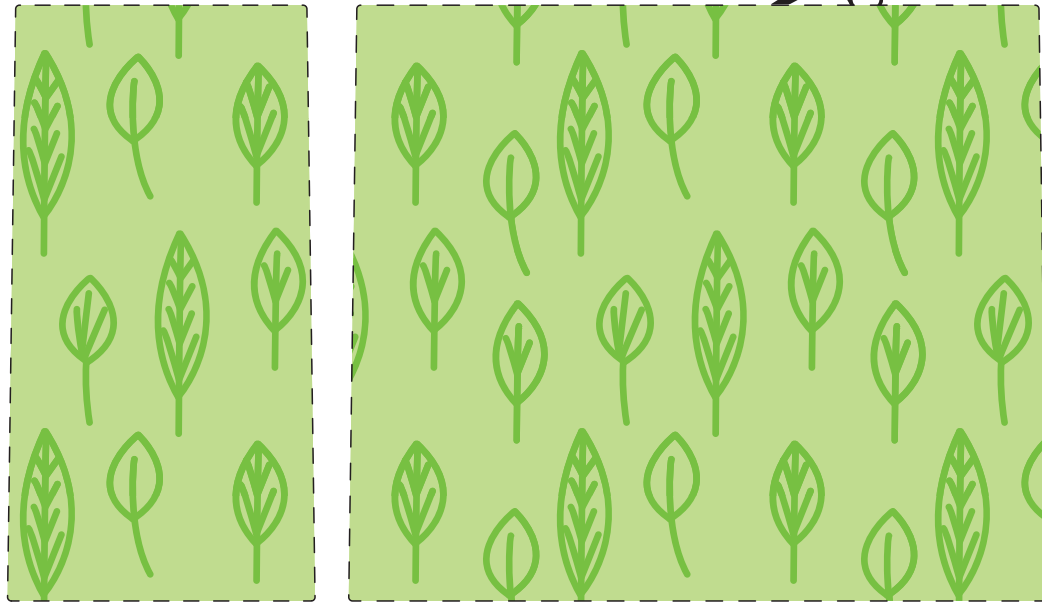
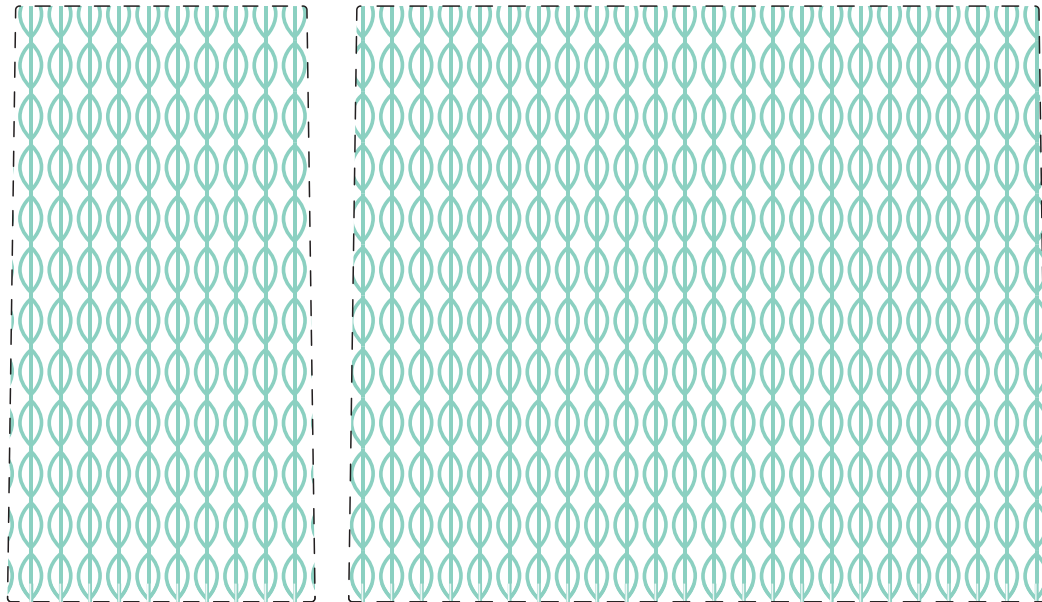

UK-Importer:  
 Playmobil UK Ltd.  
 Regency House  
 1 Miles Gray Road  
 Basildon  
 Essex  
 SS14 3RW  
 UK



FR **DONNEZ** OU **RECYCLEZ**  
 OU  
 ASSOCIATION  
 OU  
 MGRASIN  
 OU  
 LIVRAISON  
 OU  
 DÉCHÈTERIE

Adresses sur [quefairemedesdechets.fr](http://quefairemedesdechets.fr)

IT **PAP 22**  
 Raccolta carta

©2023 geobra Brandstätter Stiftung & Co. KG  
 Brandstätterstr. 2-10 • 90513 Zirndorf, Germany  
 No. 30 82 3536 02.24