

# playmobil®

## HORSES OF Waterfall



71493



# HORSES OF Waterfall

scan mich  
scan me  
scannez-moi  
escanéame



\*Wir arbeiten ständig an der Verbesserung unserer Produkte, um eine nachhaltigere Zukunft zu schaffen. Unsere neuen Horses of Waterfall-Produkte sind Teil dieses Verbesserungsprozesses und bestehen im Durchschnitt zu mehr als **80 %** aus recycelten und biobasierten Materialien.

\*Nous améliorons constamment nos produits pour agir plus durablement. La gamme Horses of Waterfall fait partie de ce processus d'optimisation permanente, et chaque produit de cette gamme est fabriqué avec plus de **80%** de matériaux recyclés et biosourcés en moyenne.

\*We are constantly improving our products to create a more sustainable future. Our new Horses of Waterfall products are part of that improvement process and are made with more than **80%** recycled and bio-based materials on average.

\*Trabajamos constantemente para mejorar nuestros productos y crear un futuro más sostenible. Nuestros nuevos productos de la línea Horses of Waterfall forman parte de ese proceso de mejora y están fabricados con una media de más del **80%** de materiales reciclados o biodegradables.

**HINWEIS**  
Note notice  
Atención



Aufbauen leicht gemacht mit nummerierten Tüten.  
Viel Spaß mit deinem neuen PLAYMOBIL-Spielzeug!

Set-up made easy with numbered bags.  
Have fun with your new PLAYMOBIL toy!

Simplicité de montage avec les sachets numérotés.  
Amuse-toi avec tes nouveaux PLAYMOBIL!

El montaje es más fácil con  
las bolsas numeradas.  
¡Diviértete con tu nuevo  
juguete de PLAYMOBIL!





# WARNING: CHOKING HAZARD

Small parts. Not for children under 3 years.

”Ne concerne que les USA“

Wichtige Unterlagen, bitte sorgfältig aufbewahren!  
Important: Please keep these instructions for future reference!  
Documents importants, à conserver soigneusement!  
¡Por favor, guarde estas instrucciones para el futuro!  
Belangrijke documenten, bewaar deze zorgvuldig!

Abbildungen können vom Original abweichen.  
Product may differ from image shown.  
Les illustrations peuvent différer de l'original.  
Las ilustraciones pueden diferir del original.  
Afbeeldingen kunnen verschillen van het  
werkelijke artikel.

Serviceadressen finden Sie in allen  
PLAYMOBIL-Prospekten

Addresses of Customer Service Depart-  
ments are shown in all PLAYMOBIL  
catalogues

L'adresse du service consommateurs  
est indiquée dans tous les catalogues  
PLAYMOBIL

Troverete gli indirizzi dei centri di  
assistenza in tutti i cataloghi PLAYMOBIL

**UK-Importer:**  
**Playmobil UK Ltd.**  
**Regency House**  
**1 Miles Gray Road**  
**Basildon**  
**Essex**  
**SS14 3RW**  
**UK**

**UK  
CA**

In alle PLAYMOBIL catalogi vindt u  
het adres van onze klantendienst.

Las Direcciones de los Departamentos  
de Servicio al Consumidor se encuentran  
en todos los catálogos PLAYMOBIL

Η διεύθυνση του Γραφείου Εξυπηρέτησης  
Καταναλωτών PLAYMOBIL βρίσκεται σε  
όλους τους καταλόγους PLAYMOBIL.

pronounced: plāy-mō-bēēl



30 82 4382



30 04 4075

30 88 7672



30 82 4362

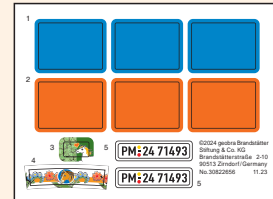

30 82 2656

30 03 1212



30 03 1442



2x 30 82 3044



4x 30 80 3756

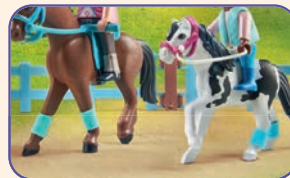

30 04 4395

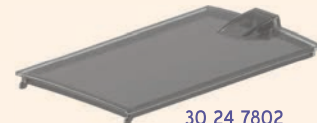

30 24 7802



+



30 04 4195



30 04 4205



30 14 8512

30 62 6369



30 11 5820

30 04 4225



30 10 5830

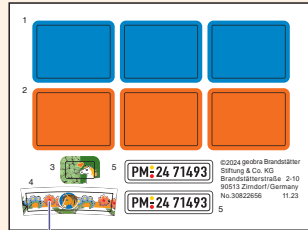

4



30 20 4244

3



30 04 4245



30 04 4235



30 63 5628

30 03 9415



30 03 9405



30 04 4485



+



1

30 04 4275



30 04 4255

30 66 2806

2

30 04 4265



30 03 9135



30 04 4285



30 04 4305

30 04 4325

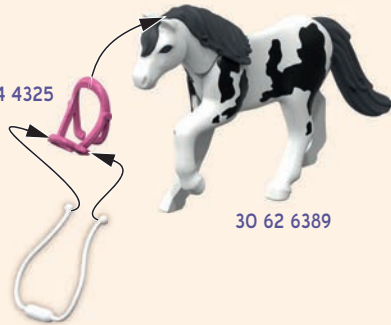

30 62 6389

30 04 4315

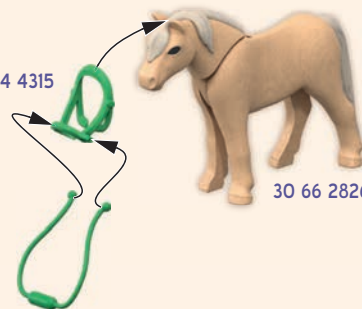

30 66 2826

30 04 4295



30 06 9724

1



+

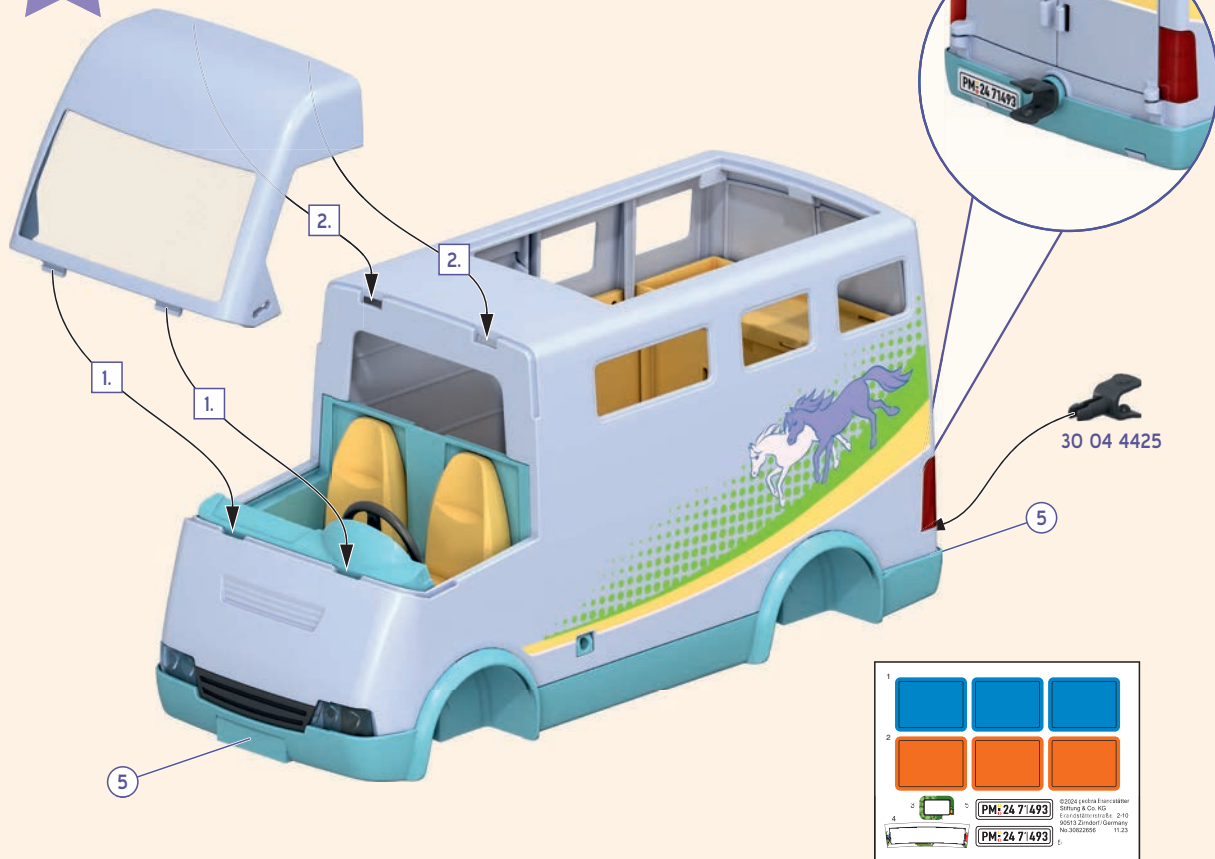

30 04 4425

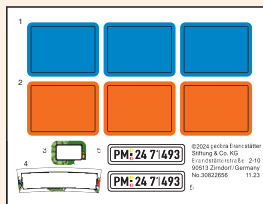

2

4x

1

30 82 4690



30 04 4405

2

30 09 9174

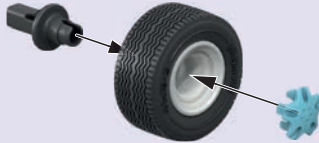

30 04 4415

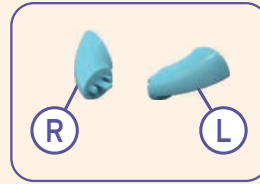

30 51 5783



30 02 9575

30 02 9565





+



2x



4x

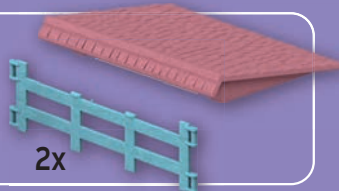

2x

+



30 07 3814

2x

30 07 3814



30 02 9865

30 03 9275

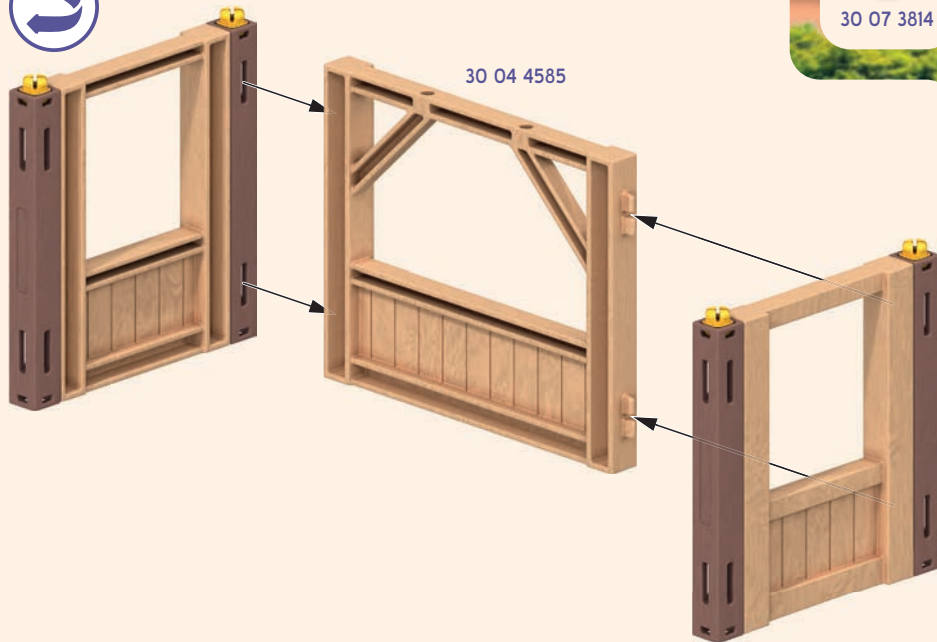

30 04 4585

2

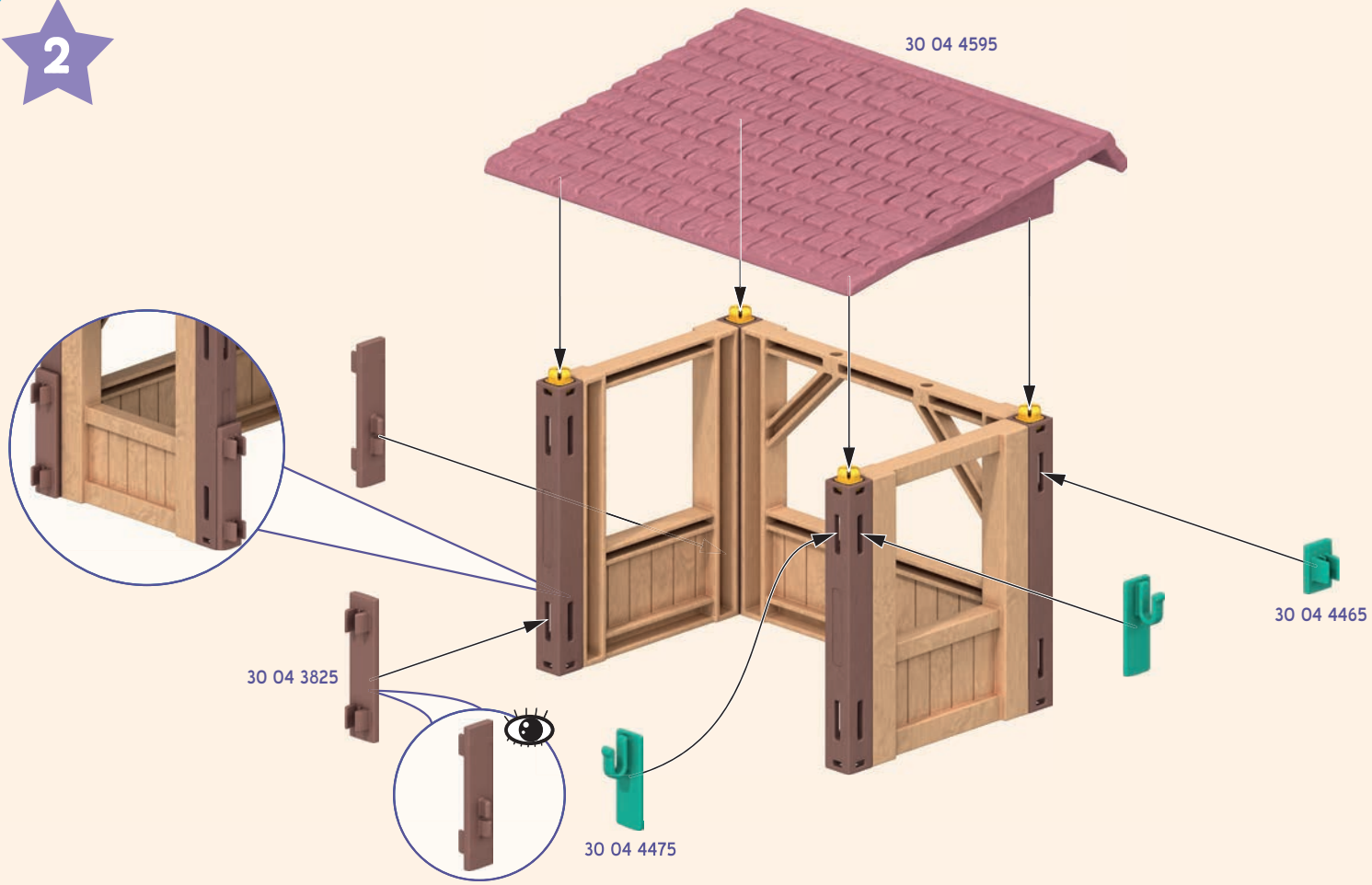

3

2x

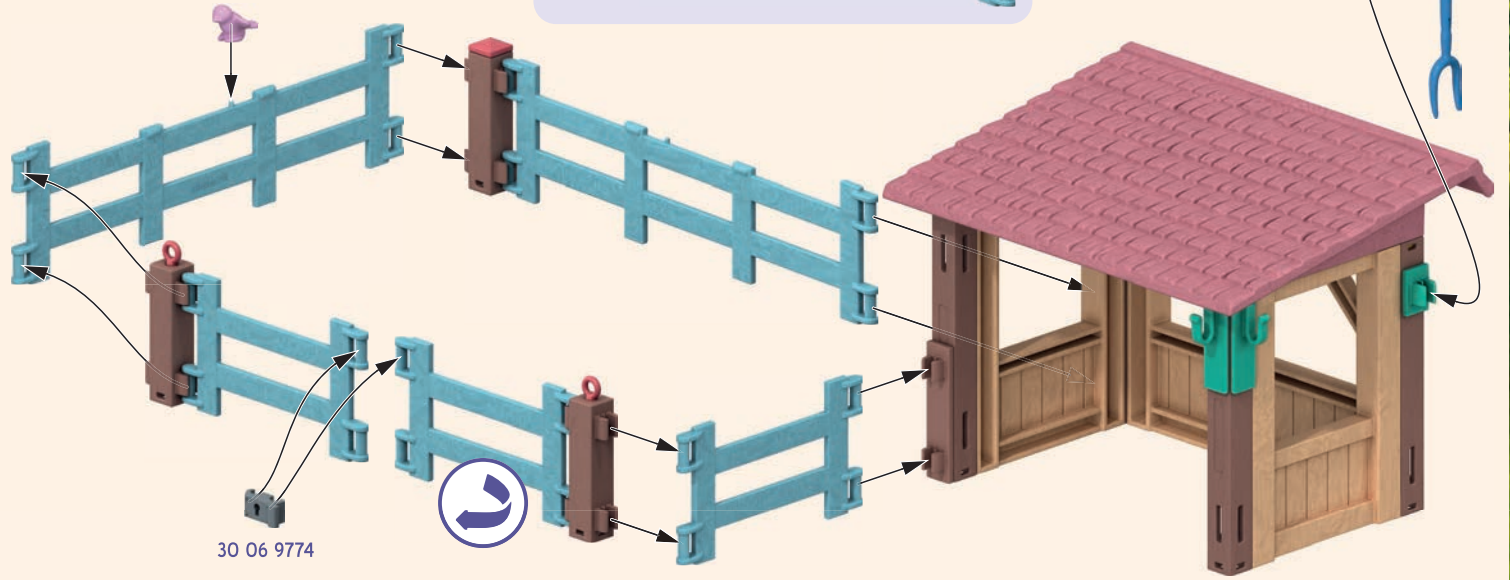
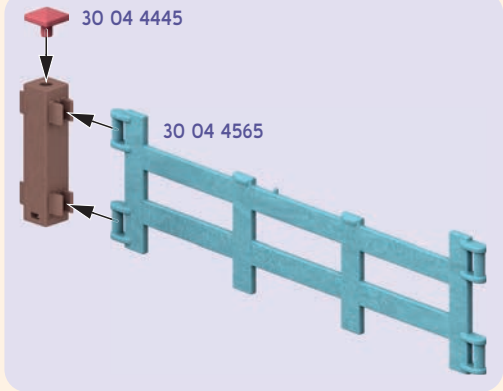
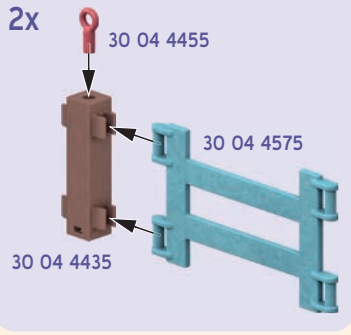

1



+



2

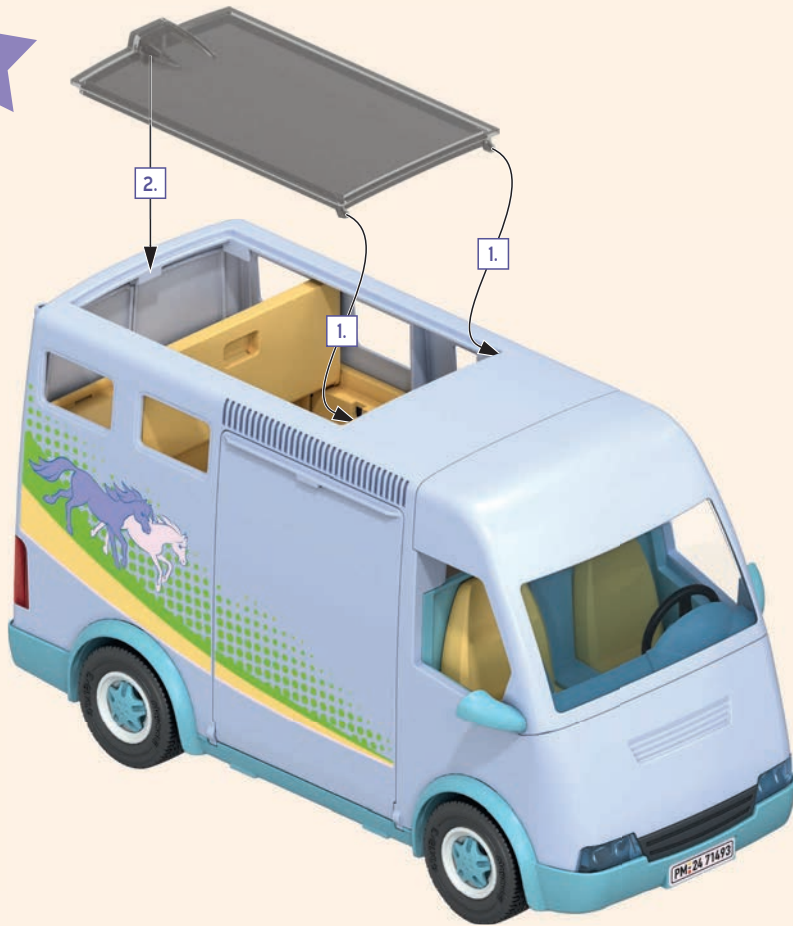

1

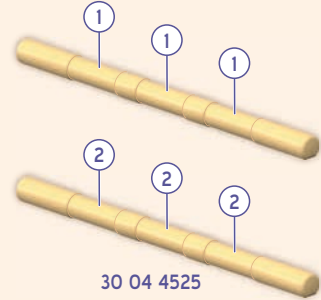
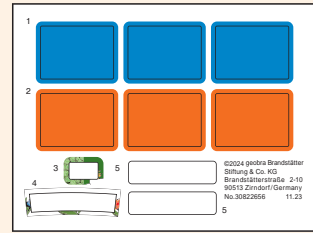

2

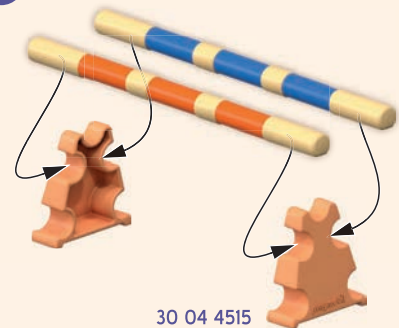

oder  
or  
ou

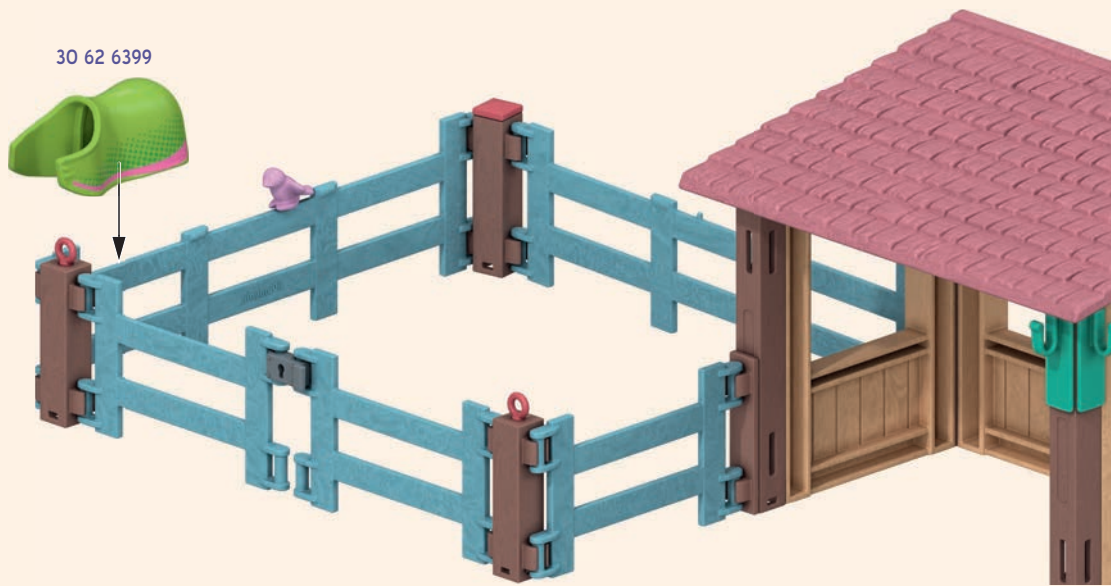

30 02 0985



30 03 5165



30 04 4555



30 04 4545



3x 30 04 4535



2x 30 02 0995



30 06 1594

Fabelhafte Pony-Abenteuer erwarten dich auf der Waterfall Ranch! Entdecke tolle Videos und kreative Bastelideen!

Fabulous pony adventures await you at Waterfall Ranch! Discover great videos and creative craft ideas!

Tes amis poneys t'attendent au Ranch de Waterfall pour de nouvelles aventures ! Découvre aussi des vidéos et des activités créatives !

¡Grandes aventuras te esperan en el Rancho de Waterfall! ¡Descubre videos y manualidades creativas!

scan mich  
scan me  
scannez-moi  
escanéame





71495



71496



71498



71497



71493



71494



FR DONNEZ OU RECYCLEZ ASSOCIATION MBRGIN OU LIVRABON DÉCHÈTERIE

Adresses sur [quefairemedesdechets.fr](http://quefairemedesdechets.fr)

©2023 geobra Brandstätter Stiftung & Co. KG • Brandstätterstr. 2-10 • 90513 Zirndorf, Germany  
11.23  
No. 30 82 4296