



\*COUNTRY BAUERNHOF PRODUKTE  
\*COUNTRY FARM PRODUCTS  
\*GAMME COUNTRY FERME

\*Im Schnitt zu über 80%  
mit recycelten und  
biobasierten Materialien.

\*With more than 80%  
recycled and bio based  
materials on average.

\*Avec plus de 80% de  
matériaux recyclés et  
biosourcés en moyenne.





# Country



\* Wir arbeiten ständig an der Verbesserung unserer Produkte, um eine nachhaltigere Zukunft zu schaffen. Unsere neuen Bauernhof-Sets sind Teil dieses Verbesserungsprozesses und bestehen im Durchschnitt zu mehr als **80 %** aus recycelten oder biobasierten Materialien.

\* We are constantly improving our products to create a more sustainable future. Our new farm products are part of that improvement process and are made with more than **80%** recycled or bio-based materials on average.

\* Nous améliorons constamment nos produits pour agir plus durablement. La gamme Country Ferme fait partie de ce processus d'optimisation permanente, et chaque produit de cette gamme est fabriqué avec plus de **80%** de matériaux recyclés et biosourcés en moyenne.

\* Trabajamos constantemente para mejorar nuestros productos y crear un futuro más sostenible. Nuestros nuevos productos de granja forman parte de ese proceso de mejora y están fabricados con una media de más del **80%** de materiales reciclados o de origen biológico.

Scan mich  
Scan me  
Scannez-moi  
escanéame

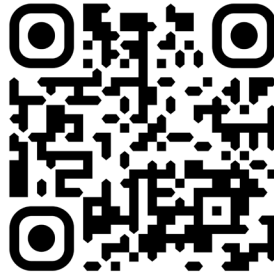

**HINWEIS**  
Note notice  
Atención

Aufbauen leicht gemacht mit nummerierten Tüten.  
Viel Spaß mit deinem neuen PLAYMOBIL-Spielzeug!

Set-up made easy with numbered bags.  
Have fun with your new PLAYMOBIL toy!

Simplicité de montage avec les sachets numérotés.  
Amuse-toi avec tes nouveaux PLAYMOBIL!

El montaje es más fácil con las bolsas numeradas.  
¡Diviértete con tu nuevo juguete de PLAYMOBIL!







# WARNING: CHOKING HAZARD

Small parts. Not for children under 3 years.

"Ne concerne que les USA"

Wichtige Unterlagen, bitte sorgfältig aufbewahren!  
Important: Please keep these instructions for future reference!  
Documents importants, à conserver soigneusement!  
¡Por favor, guarde estas instrucciones para el futuro!  
Belangrijke documenten, bewaar deze zorgvuldig!

Abbildungen können vom Original abweichen.  
Product may differ from image shown.  
Les illustrations peuvent différer de l'original.  
Las ilustraciones pueden diferir del original.  
Afbeeldingen kunnen verschillen van het werkelijke artikel.

Serviceadressen finden Sie in allen  
PLAYMOBIL-Prospekten

Addresses of Customer Service Departments are shown in all  
PLAYMOBIL catalogues

L'adresse du service consommateurs est indiquée dans tous les catalogues  
PLAYMOBIL

Troverete gli indirizzi dei centri di  
assistenza in tutti i cataloghi PLAYMOBIL

In alle PLAYMOBIL catalogi vindt u  
het adres van onze klantendienst.

Las Direcciones de los Departamentos  
de Servicio al Consumidor se encuentran  
en todos los catálogos PLAYMOBIL

Η διεύθυνση του Γραφείου Εξυπηρέτησης  
Καταναλωτών PLAYMOBIL βρίσκεται σε  
όλους τους καταλόγους PLAYMOBIL.

pronounced: plāy-mō-bēēl

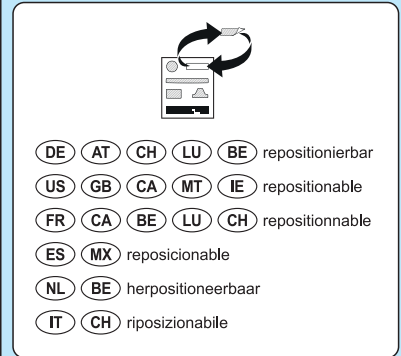
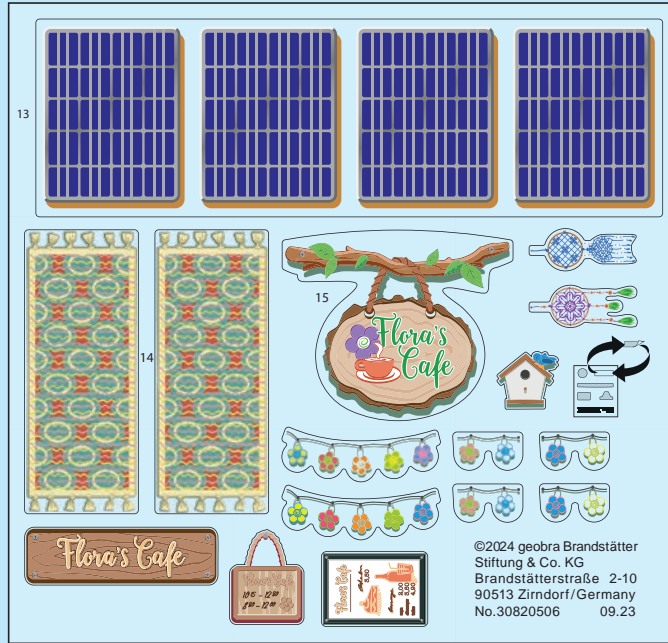





+

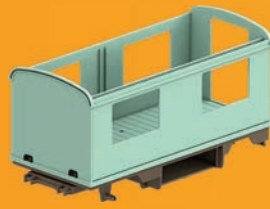

1

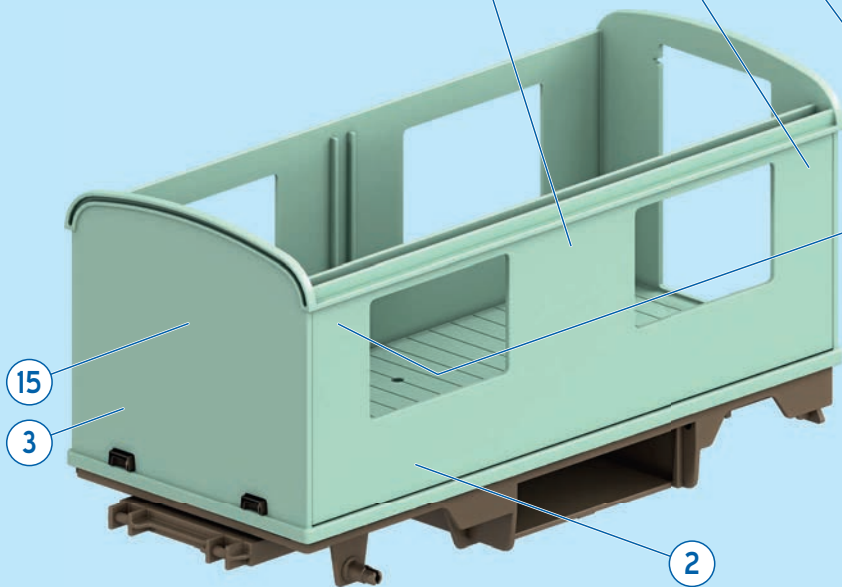
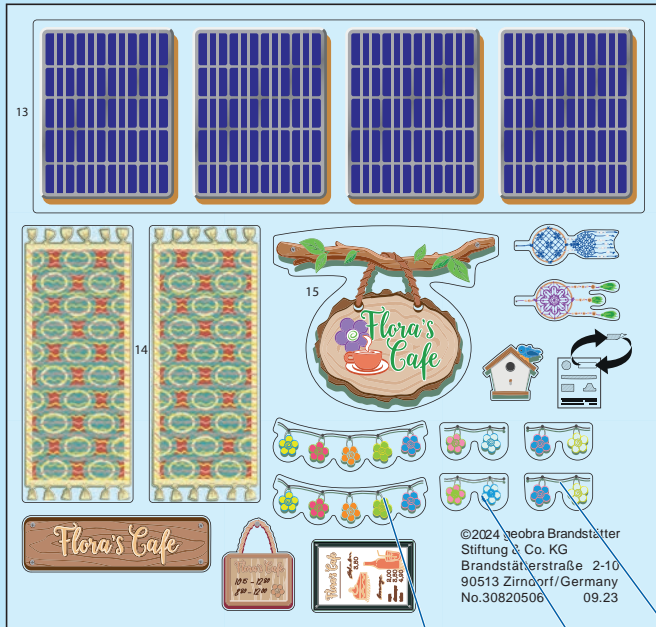



2

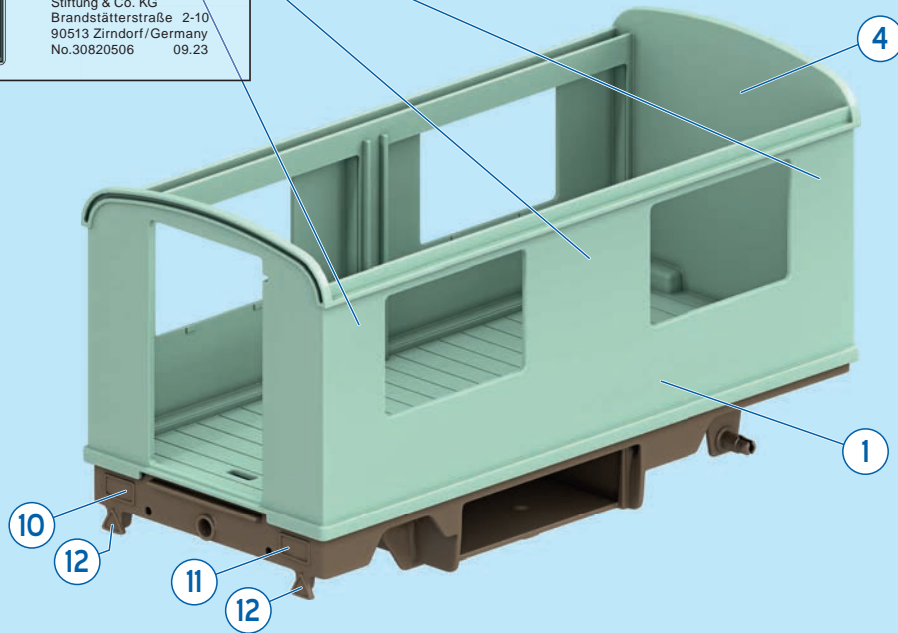
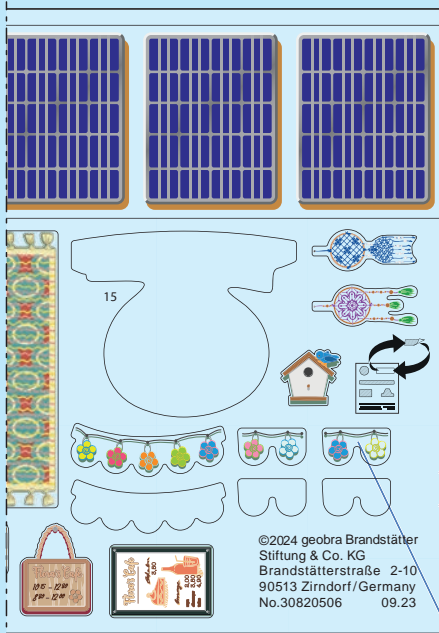

3

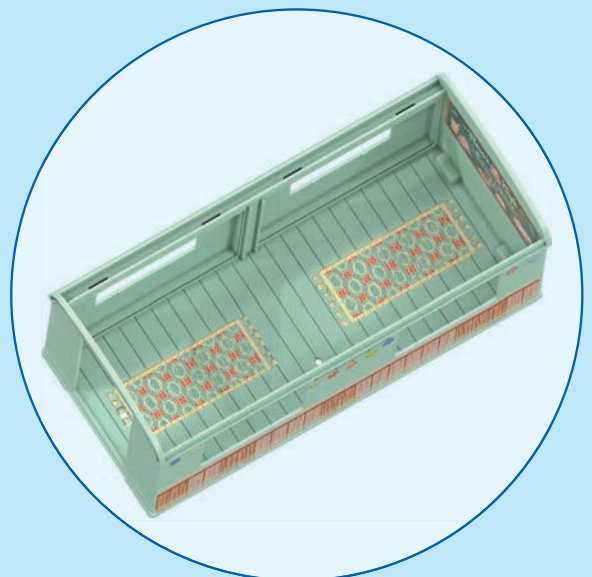



4



5

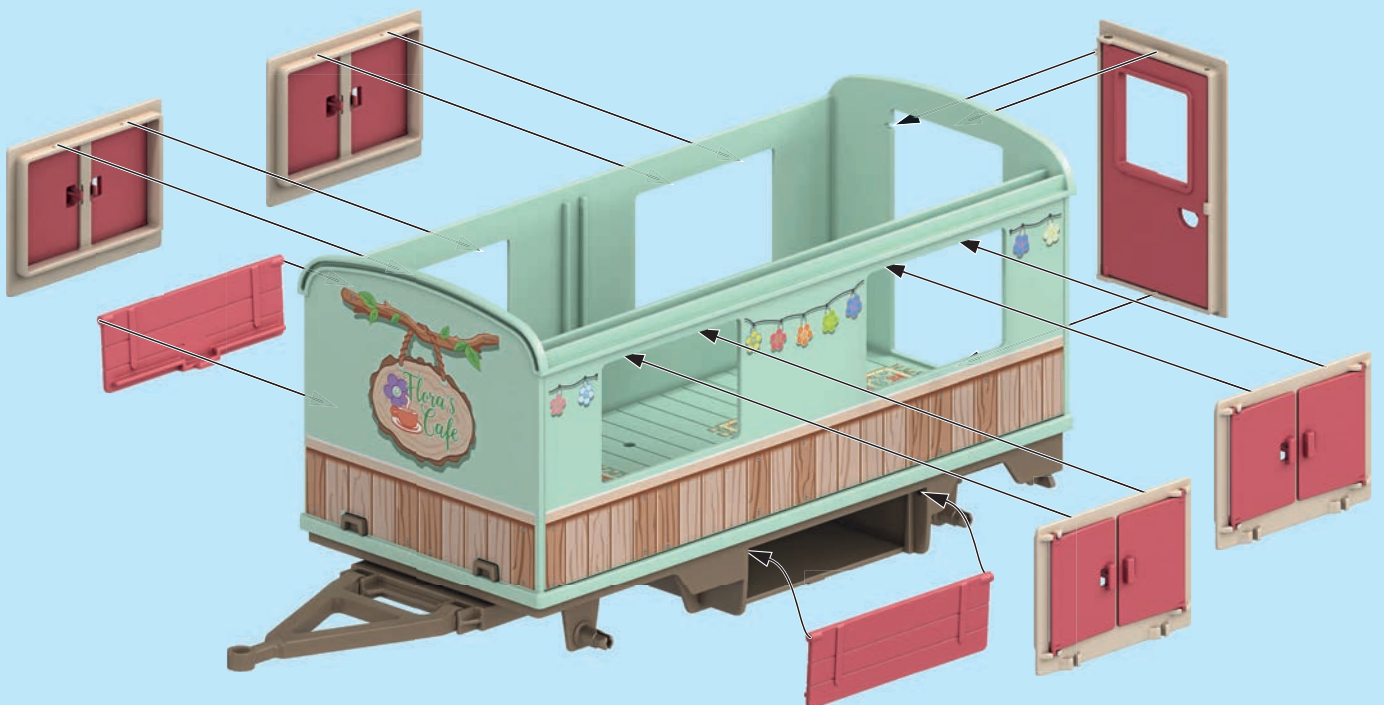
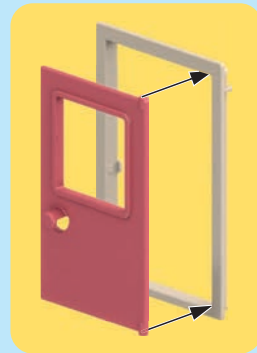
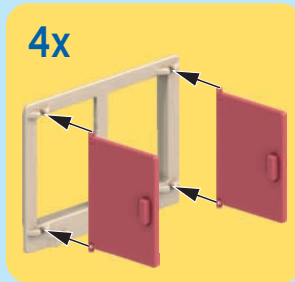









8



9

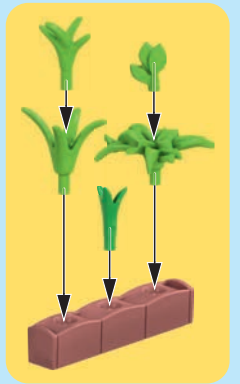





+



10

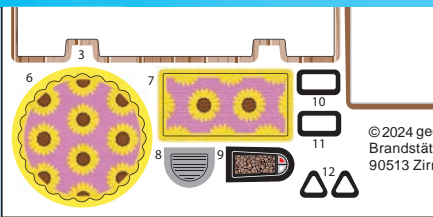
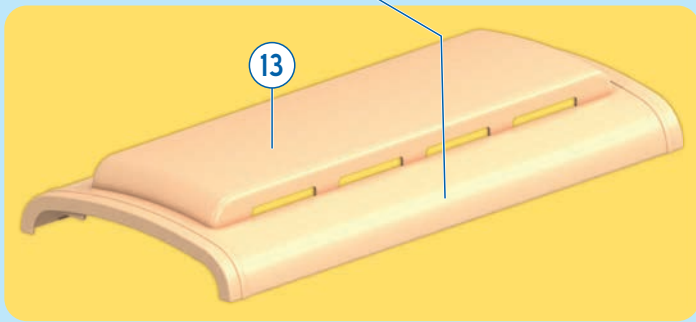
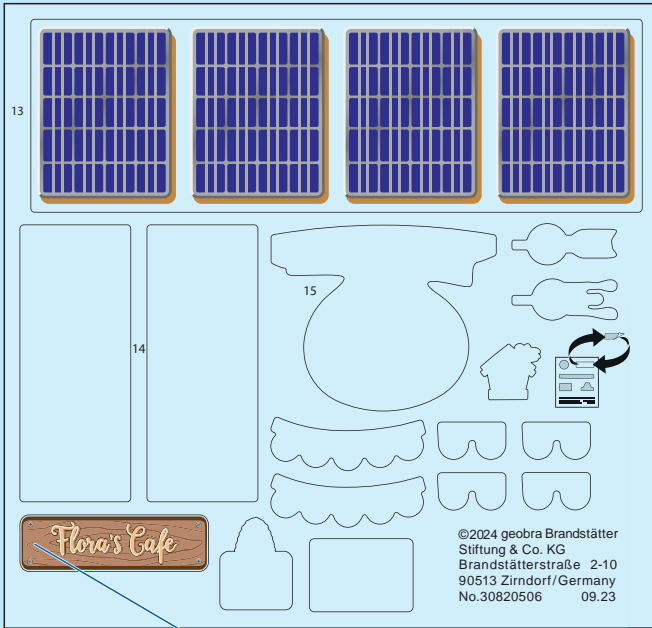

11



2x



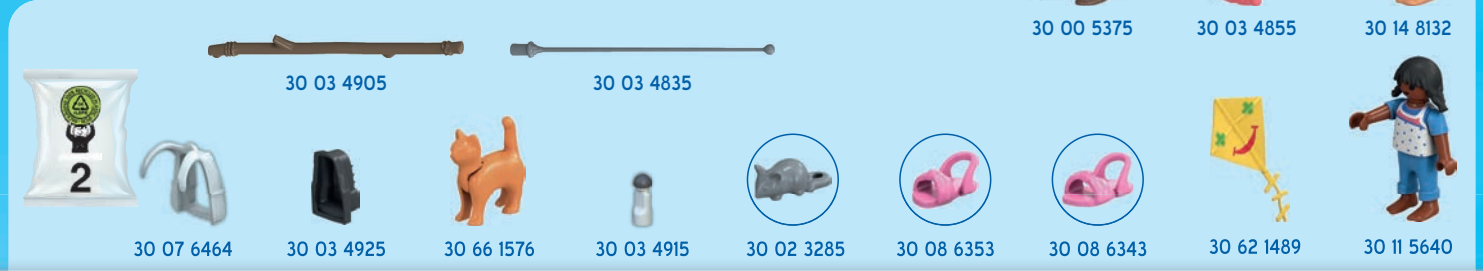
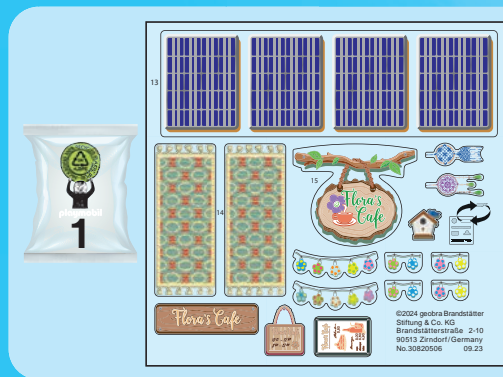
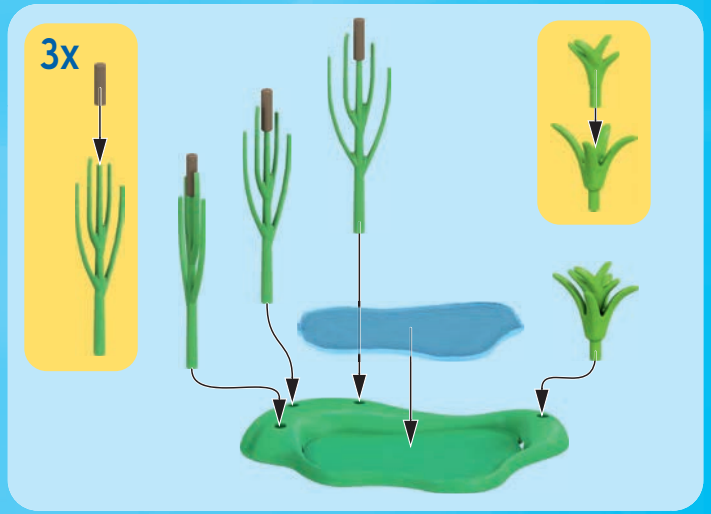
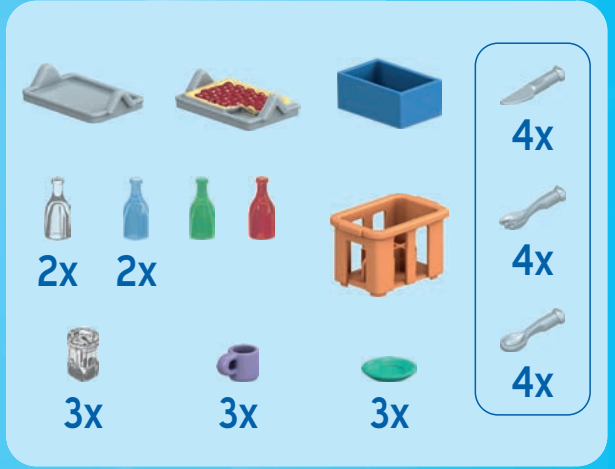
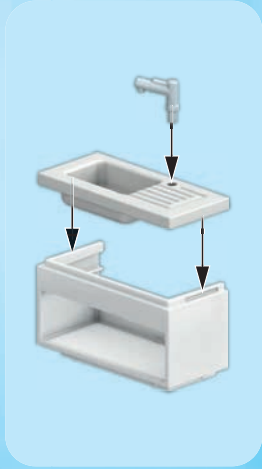
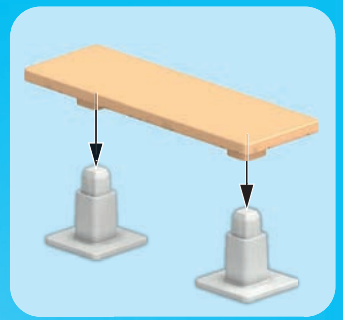
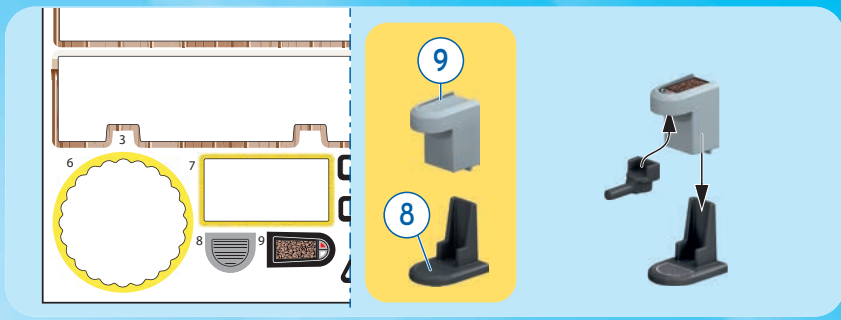





UK-Importer:  
 Playmobil UK Ltd.  
 Regency House  
 1 Miles Gray Road  
 Basildon  
 Essex  
 SS14 3RW  
 UK

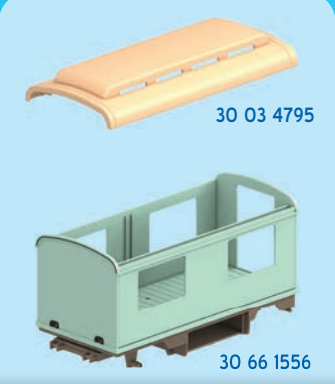





71442



71445



71444



71441



71443

**FR** **DONNEZ** **OU** **RECYCLEZ**
  
 ASSOCIATION **OU** **OU** **OU** **OU** **OU**
  
 MISE EN **OU** **OU** **OU** **OU** **OU**
  
 LIVRAISON **OU** **OU** **OU** **OU** **OU**
  
 DÉCHÈTERIE
   
 Adresses sur [quefairemedeschets.fr](http://quefairemedeschets.fr)
  
 PAP 22 **Raccolta carta**
  
 © 2023 geobra Brandstätter Stiftung & Co. KG
   
 Brandstätterstr. 2-10 • 90513 Zirndorf, Germany
   
 No. 30 82 1656 09.23