

playmobil®

Family fun



71424



Aufbauen leicht gemacht mit nummerierten Tüten. Viel Spaß mit deinem neuen PLAYMOBIL-Spielzeug!

Set-up made easy with numbered bags. Have fun with your new PLAYMOBIL toy!

Simplicité de montage avec les sachets numérotés. Amuse-toi avec tes nouveaux PLAYMOBIL!

El montaje es más fácil con las bolsas numeradas. ¡Diviértete con tu nuevo juguete de PLAYMOBIL!



WARNING: CHOKING HAZARD

Contains a small ball and small parts. Not for children under 3 years.

"Ne concerne que les USA"

UK-Importer:
Playmobil UK Ltd.
Regency House
1 Miles Gray Road
Basilidon
Essex
SS14 3RW
UK



Wichtige Unterlagen, bitte sorgfältig aufbewahren!
 Important: Please keep these instructions for future reference!
 Documents importants, à conserver soigneusement!
 ¡Por favor, guarde estas instrucciones para el futuro!
 Belangrijke documenten, bewaar deze zorgvuldig!

Abbildungen können vom Original abweichen.
 Product may differ from image shown.
 Les illustrations peuvent différer de l'original.
 Las ilustraciones pueden diferir del original.
 Afbeeldingen kunnen verschillen van het werkelijke artikel.

Serviceadressen finden Sie in allen PLAYMOBIL-Prospekten
 Addresses of Customer Service Departments are shown in all PLAYMOBIL catalogues

L'adresse du service consommateurs est indiquée dans tous les catalogues PLAYMOBIL

Troverete gli indirizzi dei centri di assistenza in tutti i cataloghi PLAYMOBIL

In alle PLAYMOBIL catalogi vindt u het adres van onze klantendienst.

Las Direcciones de los Departamentos de Servicio al Consumidor se encuentran en todos los catálogos PLAYMOBIL

Η διεύθυνση του Γραφείου Εξυπηρέτησης Καταναλωτών PLAYMOBIL βρίσκεται σε όλους τους καταλόγους PLAYMOBIL.

pronounced: plây-mô-beel



FR
DONNEZ
 OU
RECYCLEZ



ASSOCIATION



MAGASIN



LIVRAISON



DÉCHÈTERIE

Adresses sur quefairedemesdechets.fr

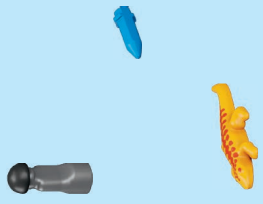
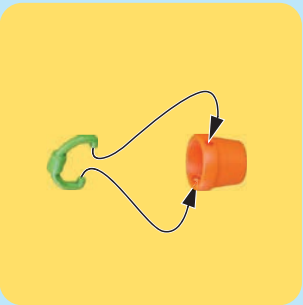
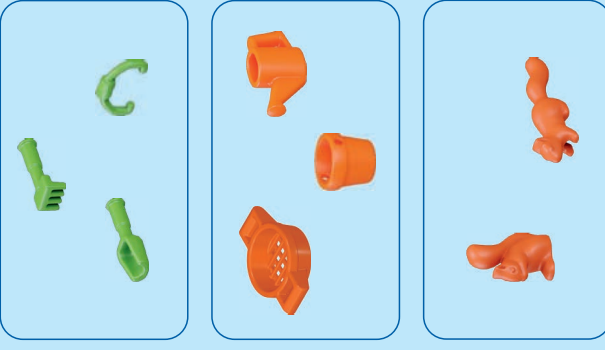
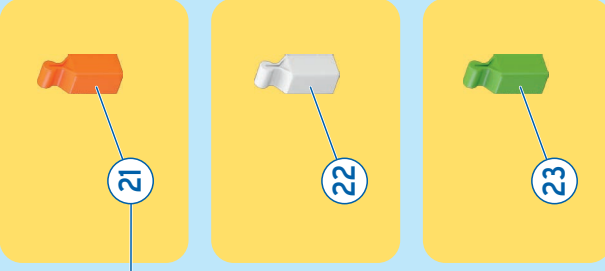
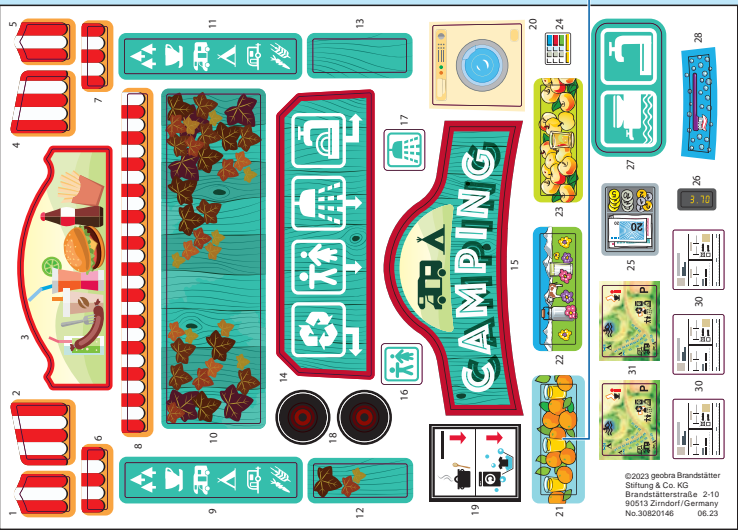
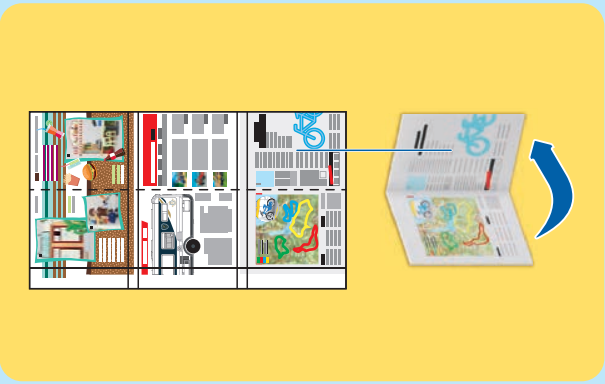

2x

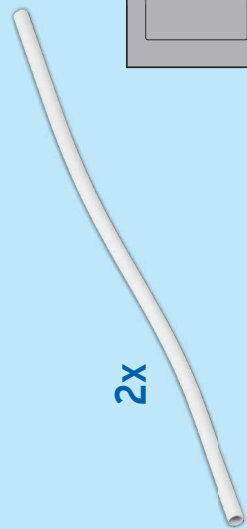

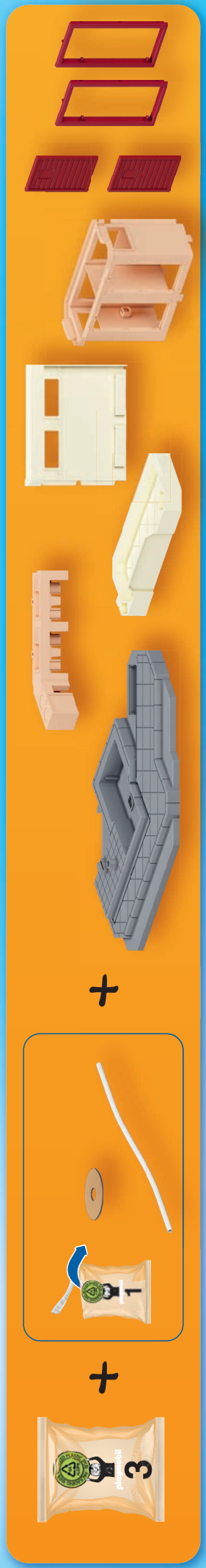

1

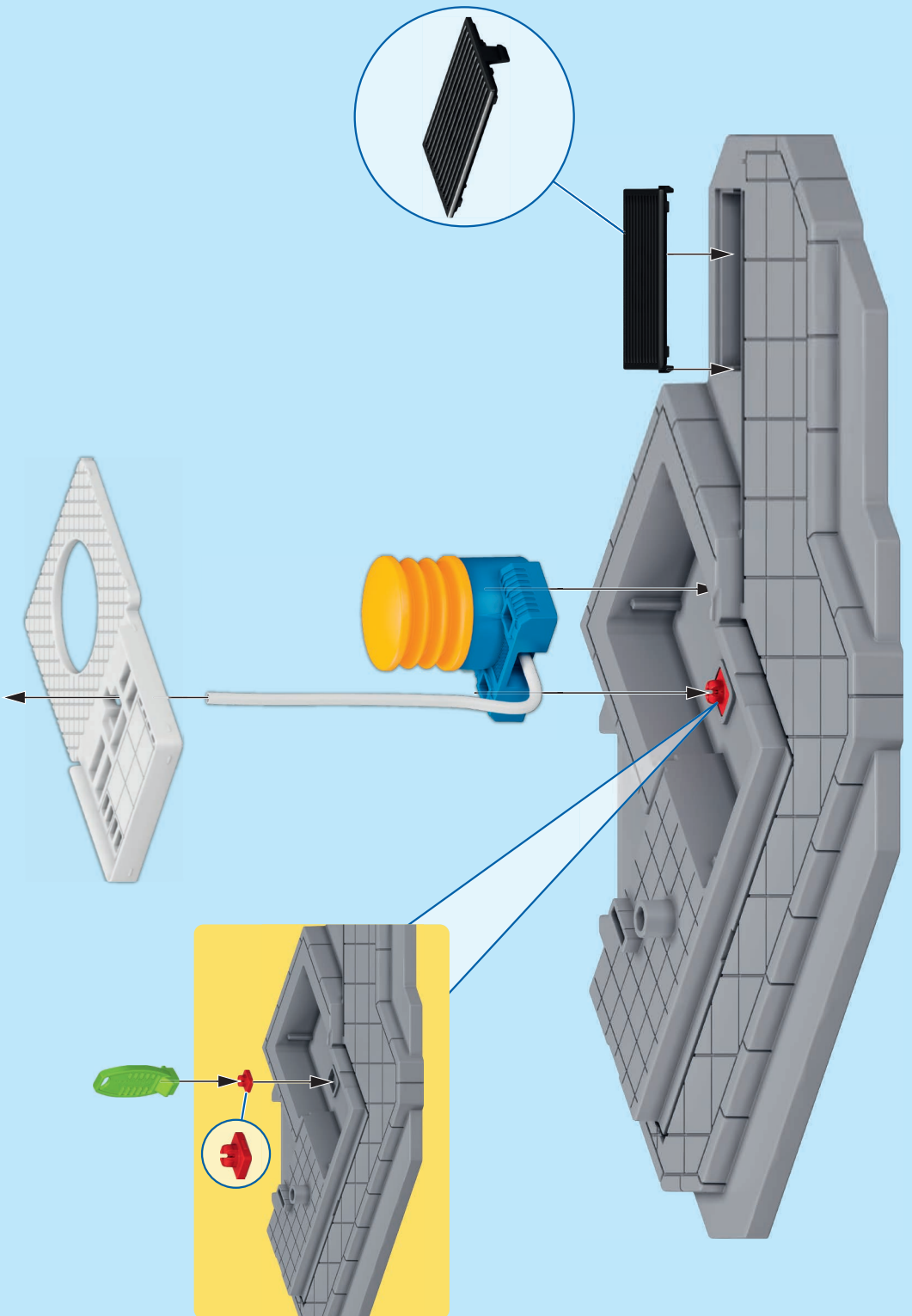
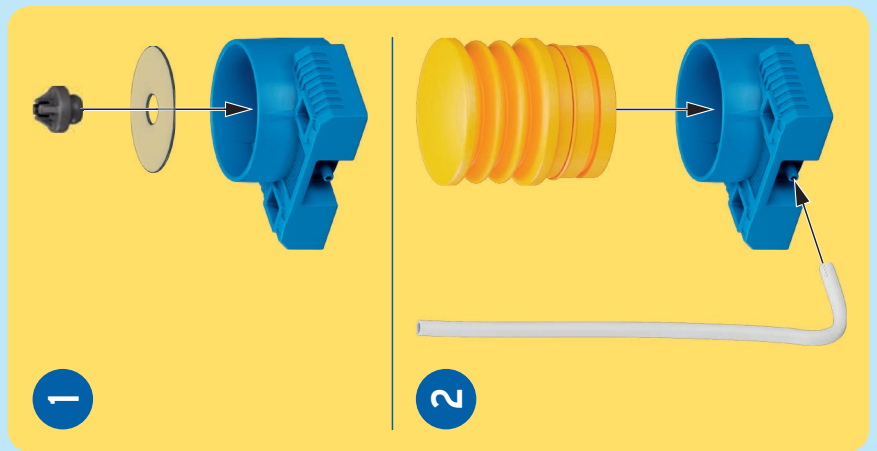

2

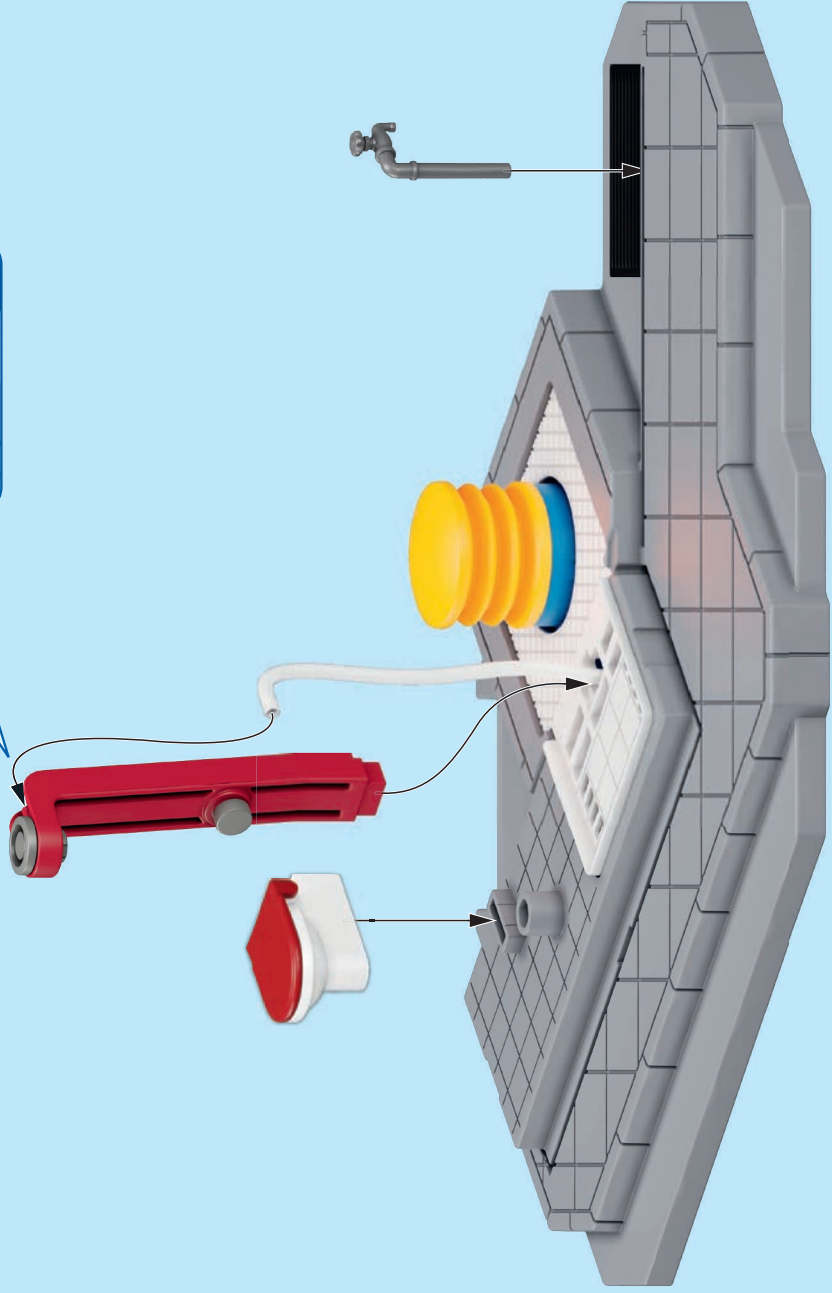
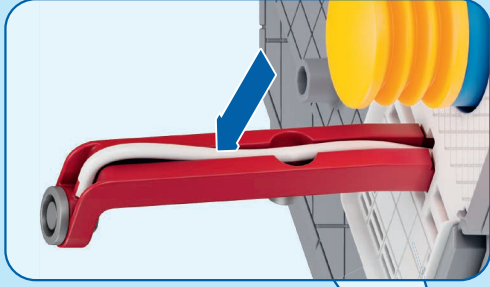
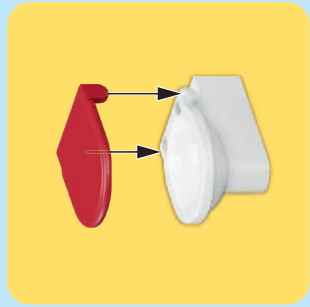
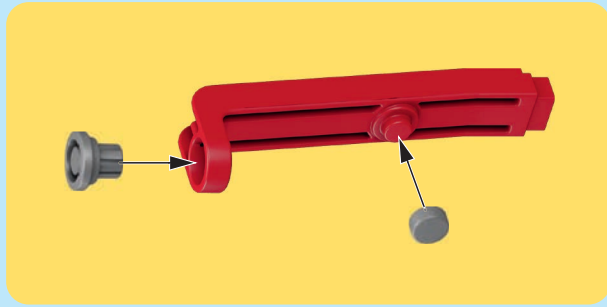

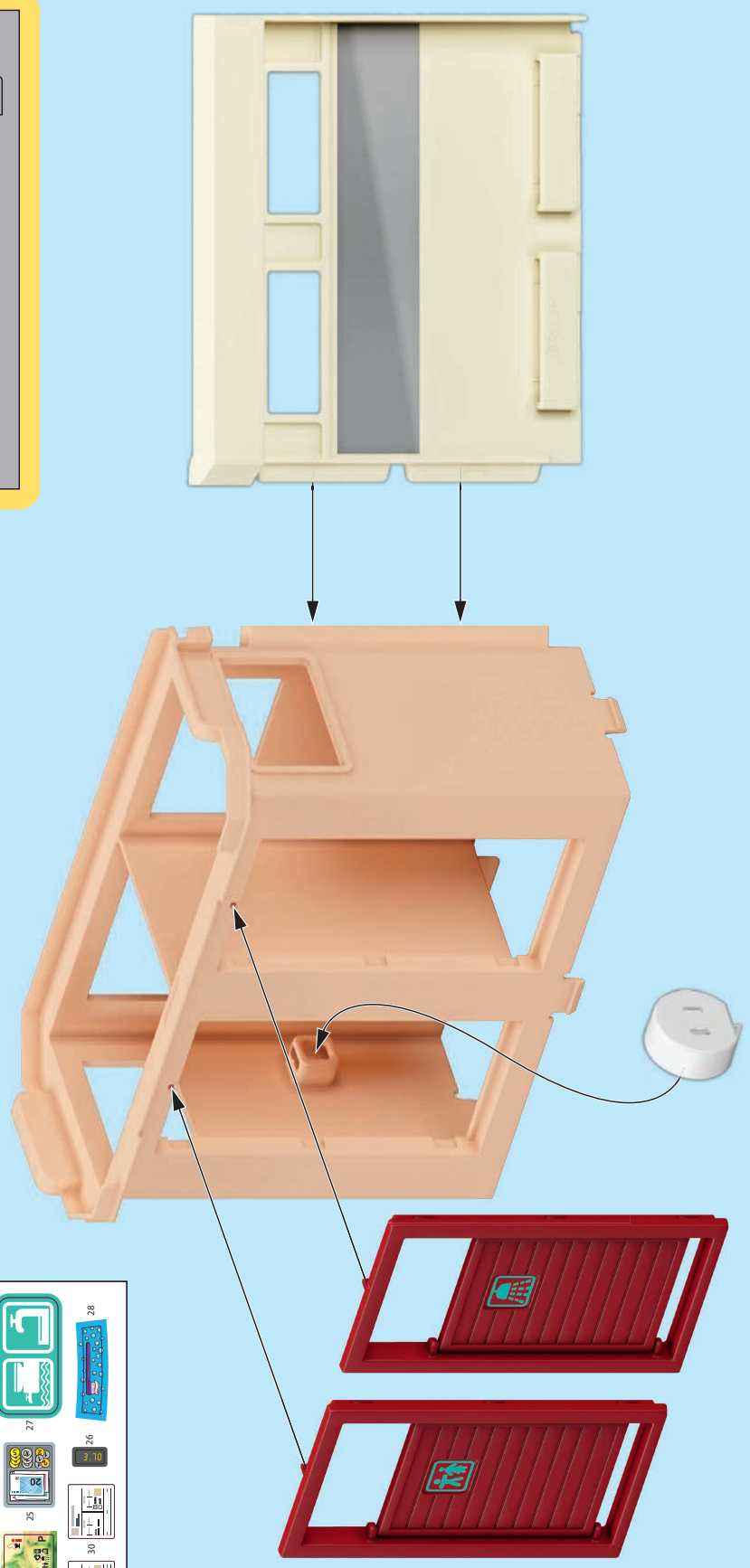
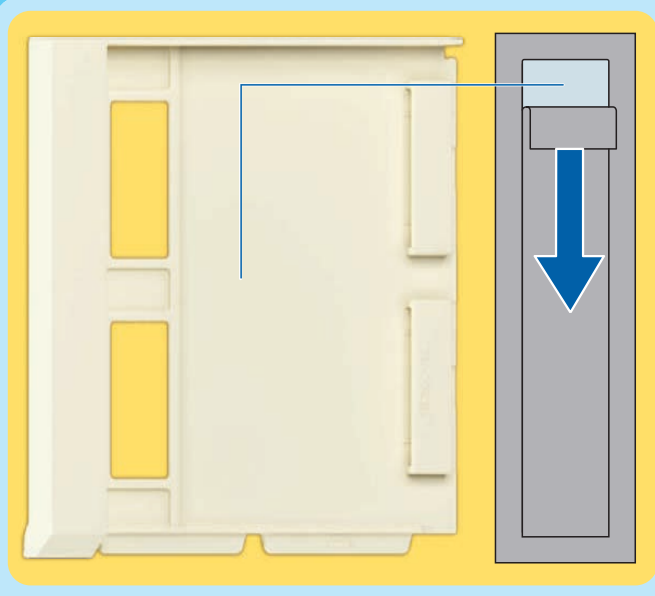
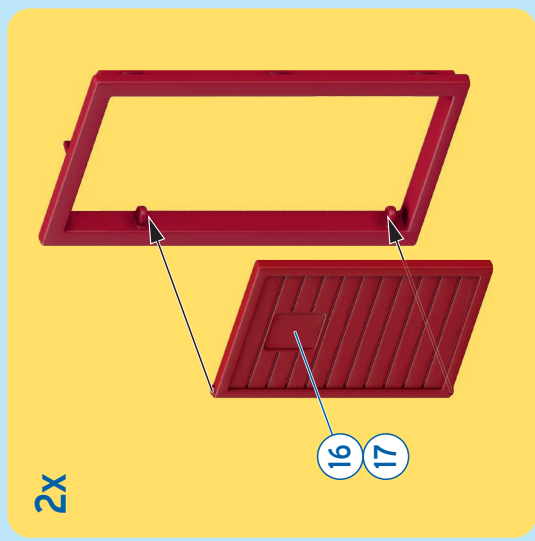
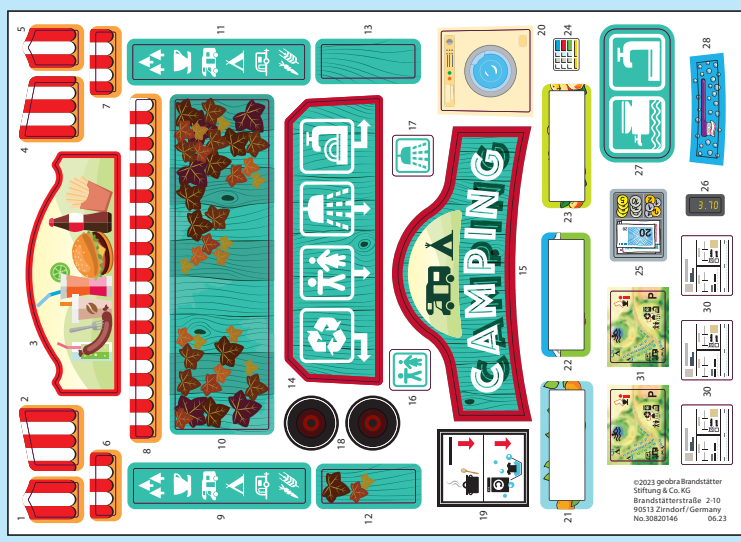

4

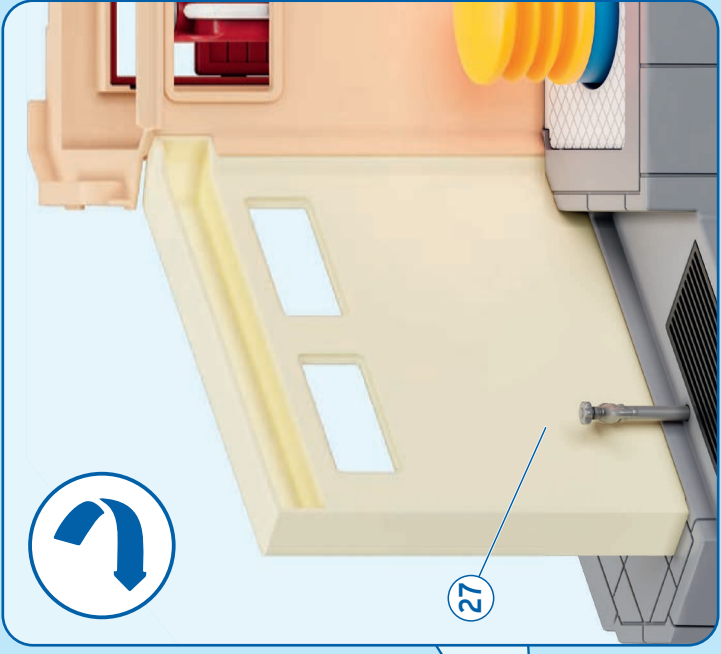
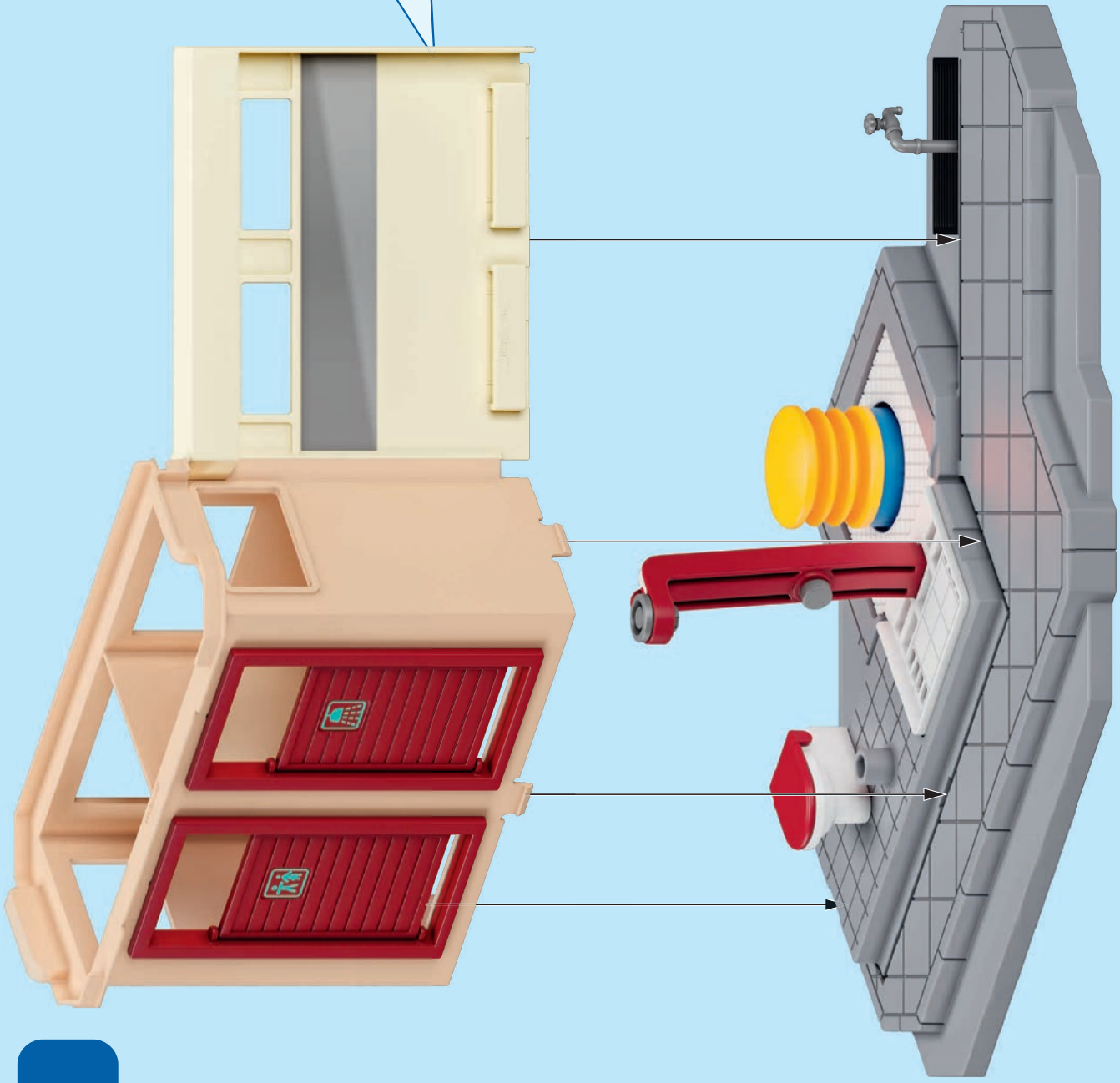

5

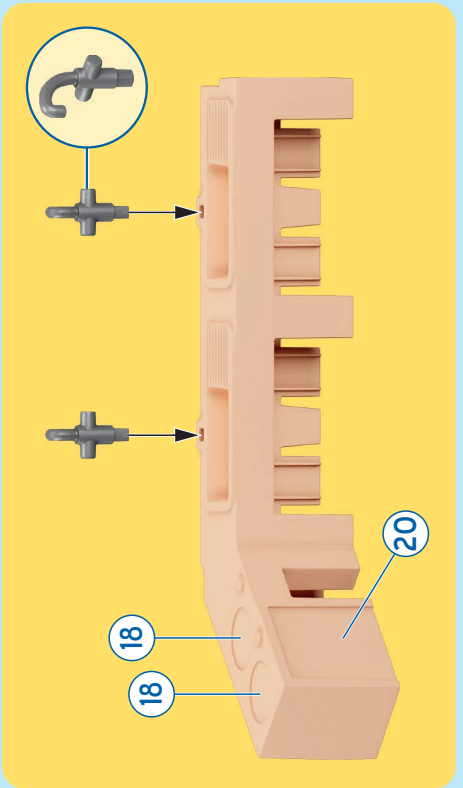
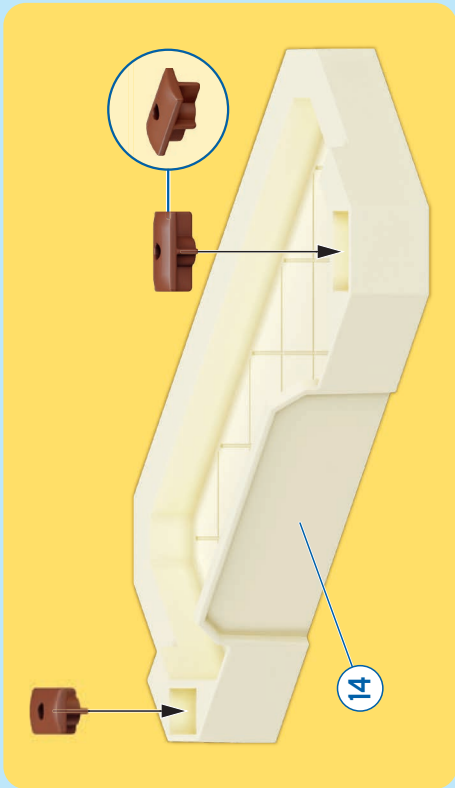
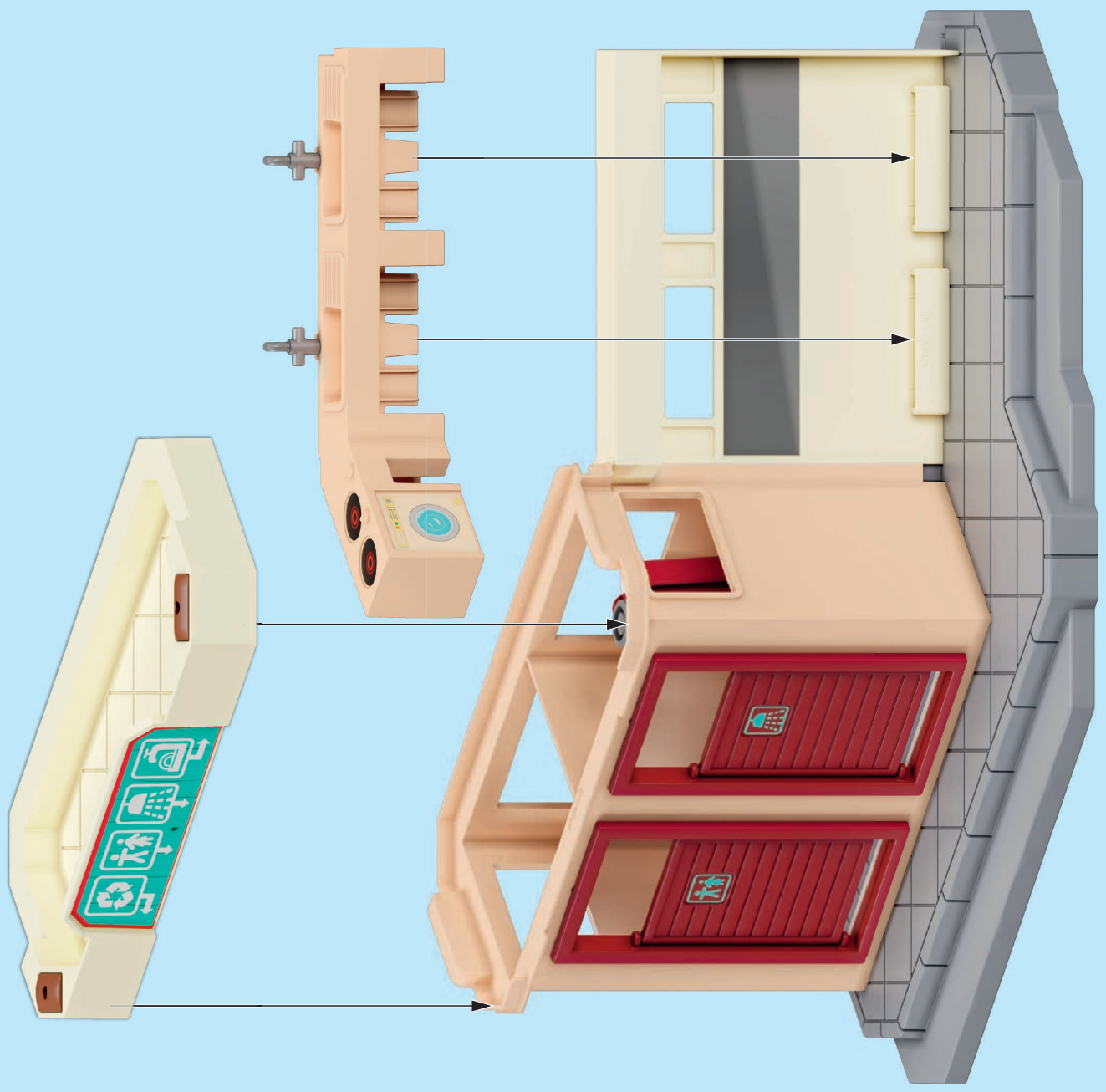
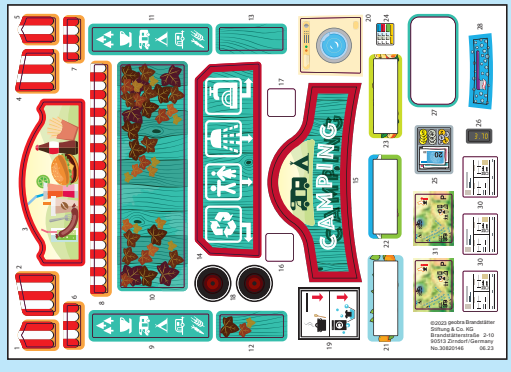

2x

1

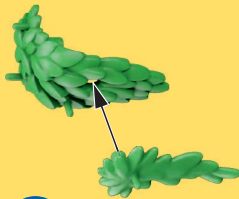

2

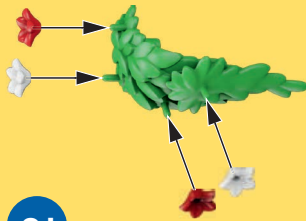

2x

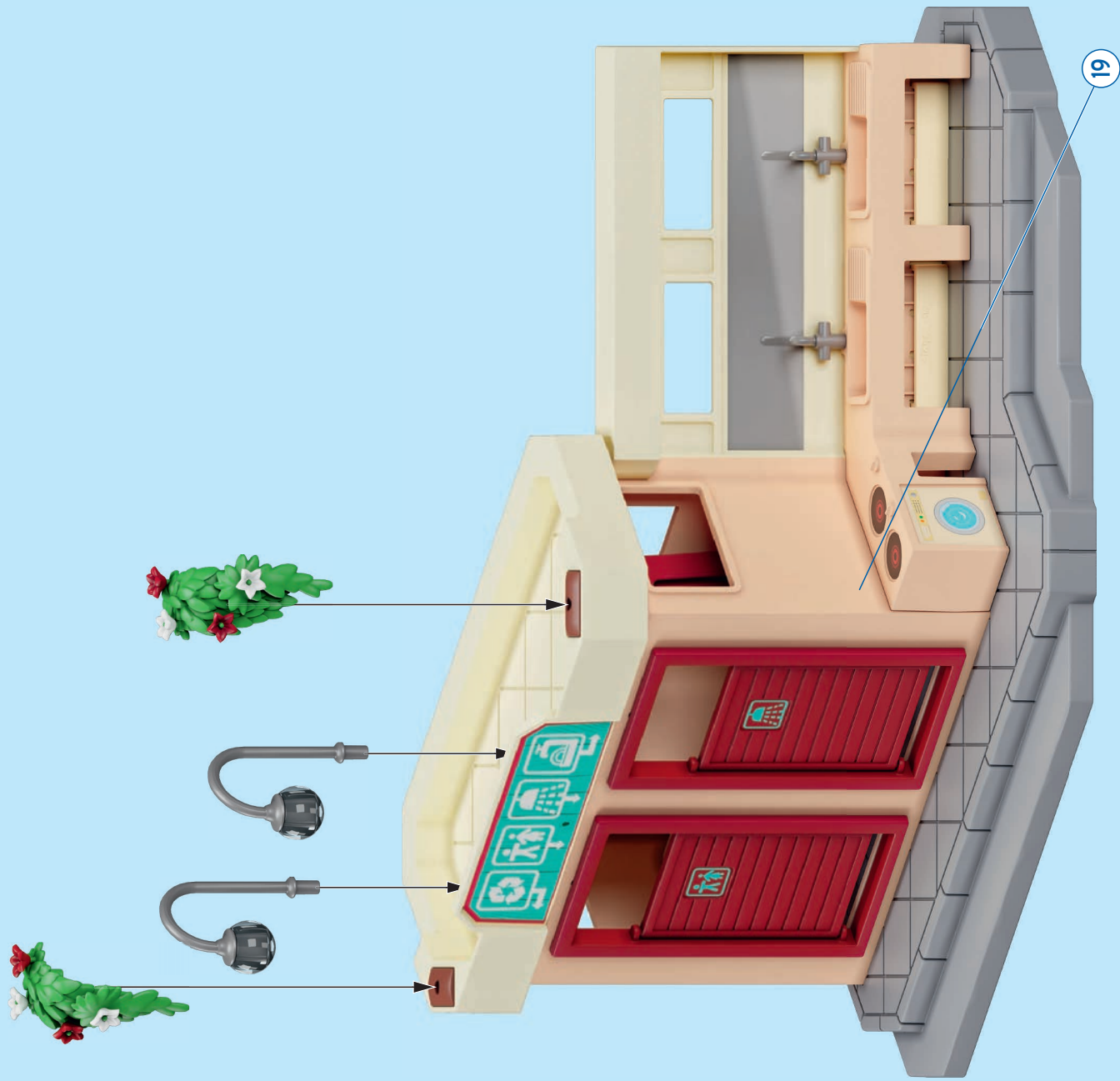
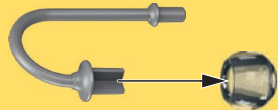

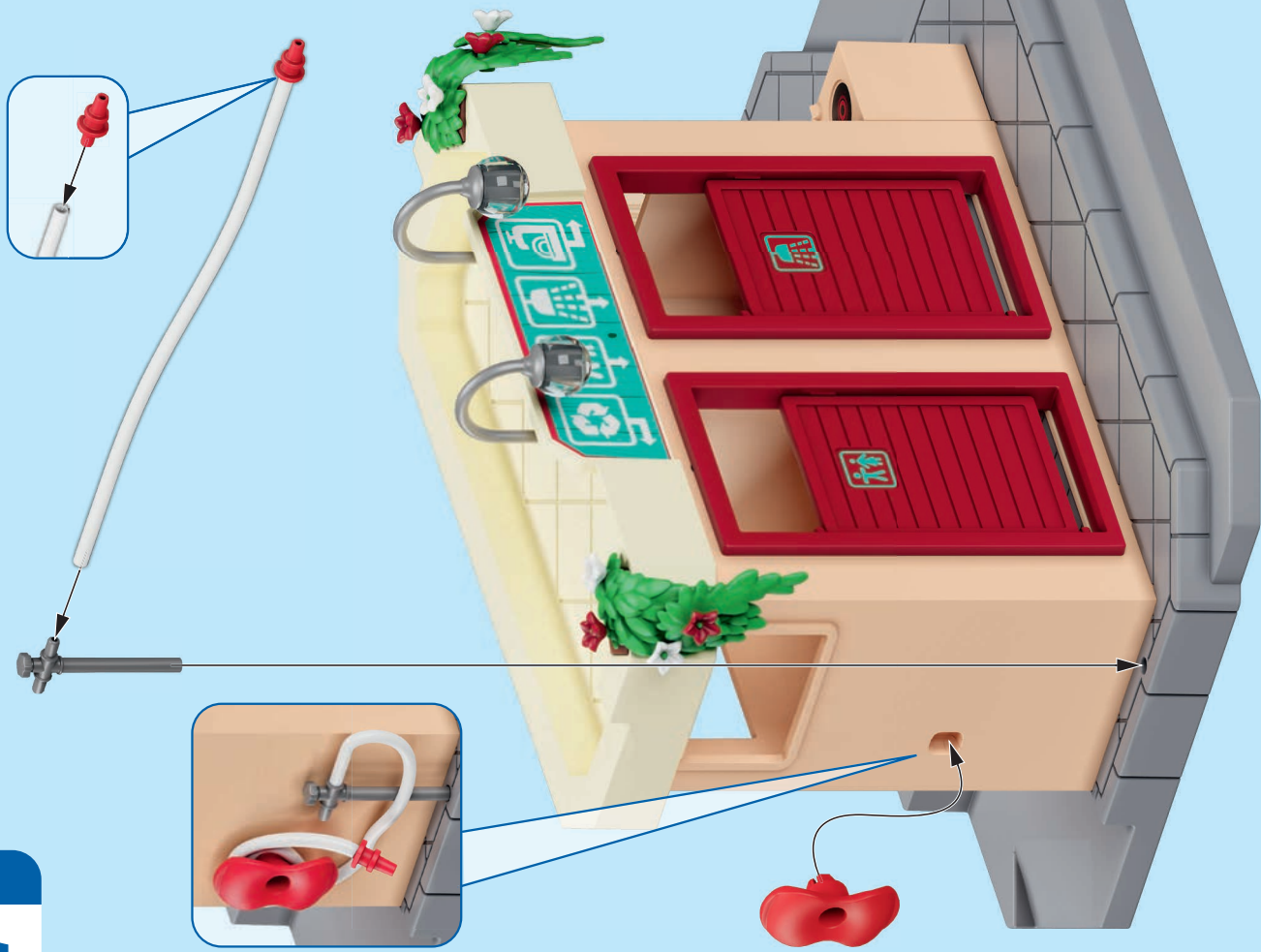

DE **AT** **CH** **LU** **BE** Nur Trinkwasser verwenden.
Nach dem Spielen austrocknen lassen.

US **GB** **CA** **MT** **IE** Use only tap water. Dry thoroughly after play.

FR **CA** **BE** **LU** **CH** N'utiliser que de l'eau potable.
Faire sécher après chaque utilisation.

ES **MX** Utilizar solamente agua potable. Dejar secar antes de guardar.

NL **BE** Enkel drinkbaar water gebruiken. Na het spelen laten drogen.

IT **CH** Usare solo acqua potabile. Asciugare bene dopo ogni uso.

PT Utilizar somente água potável. Deixar secar antes de guardar.

DK Anvend kun drikkevand. Lad det tørre ud når du er færdig med at lege.

NO Kun drikkevann skal benyttes. Tørk opp etter at leken er ferdig.

SE **FI** Använd endast dricksvatten. Låt torka efter användandet.

FI Käytä ainoastaan juomavettä. Anna kuivua leikin jälkeen.

HU Kérjük kizárólag ivóvizet használni! Játék után ajánlott a termék kiszáradása!

CZ Používat jen pitnou vodu. Po hraní nechat vyschnout.

EE Kasutada üksnes joogivetti Mängimise järel kuivatada!

LV Izmantot tikai dzeramo ūdeni. Pēc spēlēšanās ļaut nožūt.

LT Naudokite tik geriamąjį vandenį. Pažaidus, išdžiovinkite.

SI V igračo živajte le pitno vodo. Po igri naj se igrača posuši.

SK Používať iba pitnú vodu. Po hre nechať vyschnúť.

PL Używać tylko wodę pitną. Po zabawie pozostaw do wyschnięcia.

TR **CY** Sadece içme suyu kullanınız. Oyundan sonra kurumaya bırakın.

GR **CY** Χρησιμοποιείτε μόνο νερό βρύσης. Μόλις τελειώσετε, αφήστε το παιχνίδι να στεγνώσει εντελώς.

RO Se folosește doar apă potabilă. După joc se lasă să se usuce.

BG Използвайте само питейна вода. След игра оставете да изсъхне.

HR Koristiti samo pitku vodu. Poslije igranja pustiti da se osuši.

RU Используйте только питьевую воду. Дайте высохнуть после игры.

CN 仅使用饮用水。玩耍后要干燥。

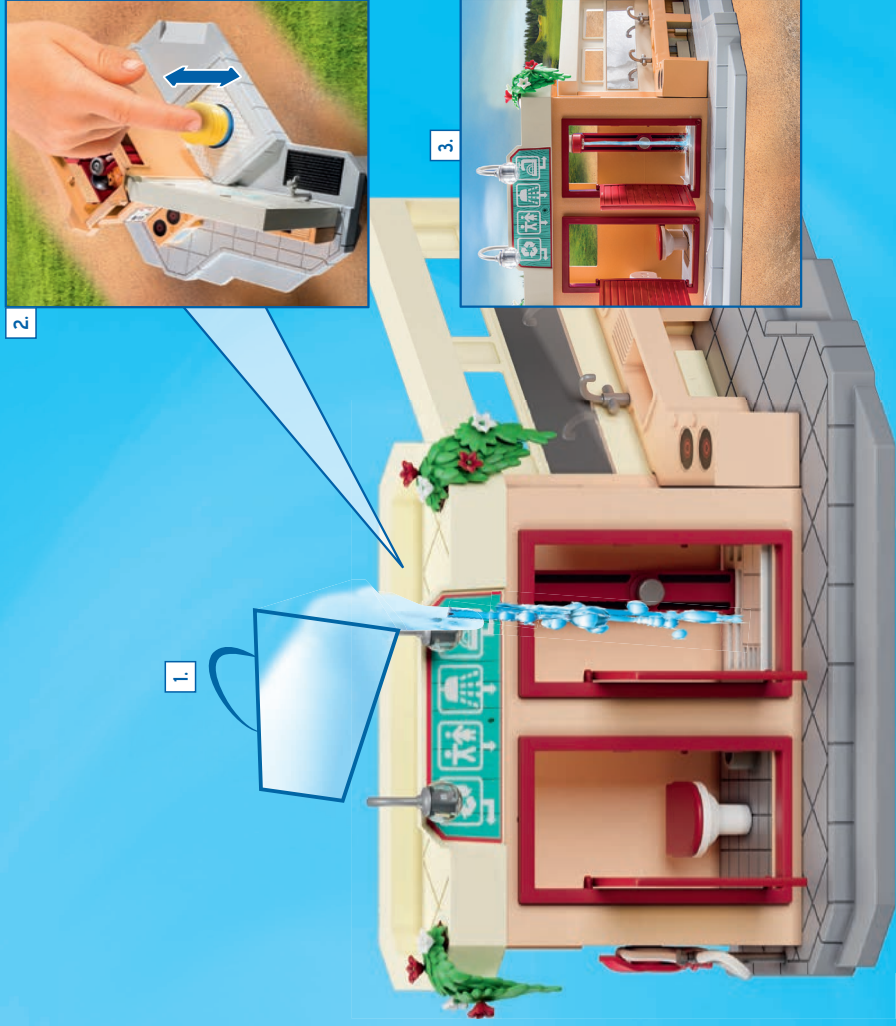



+

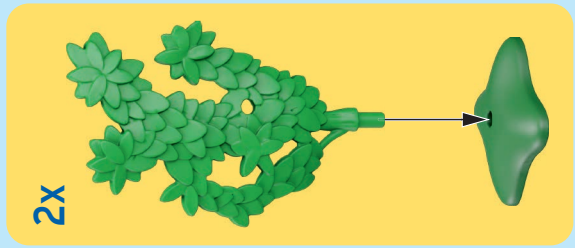
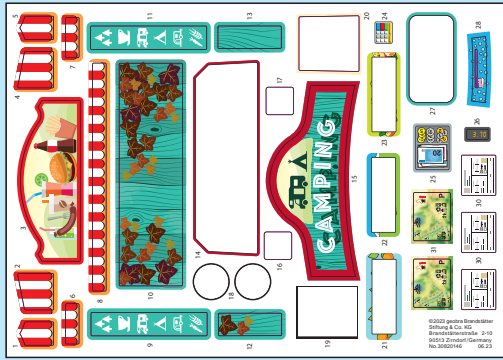

2x

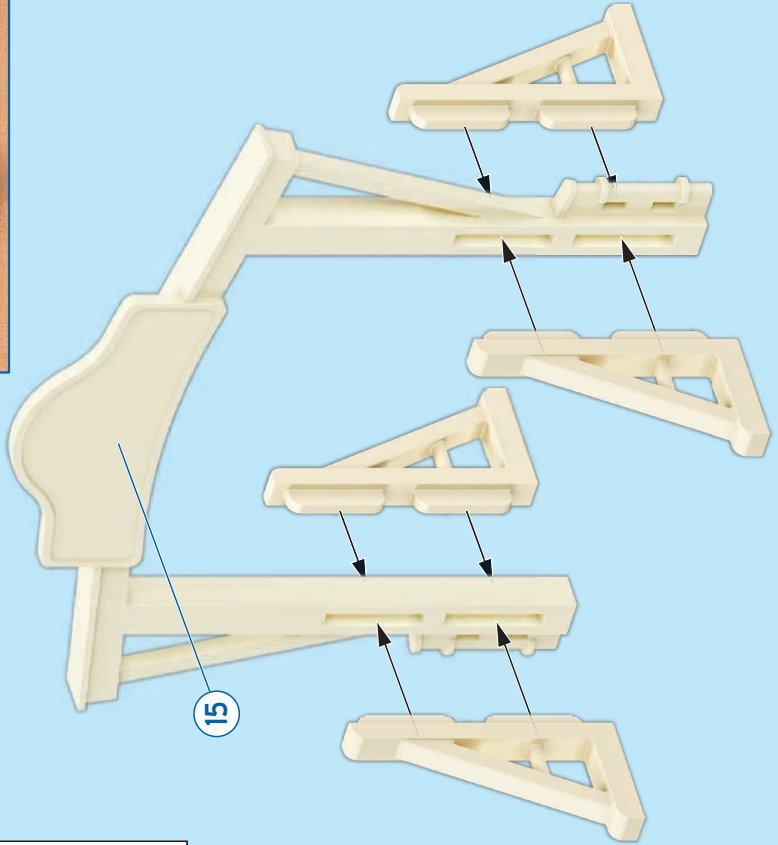

15

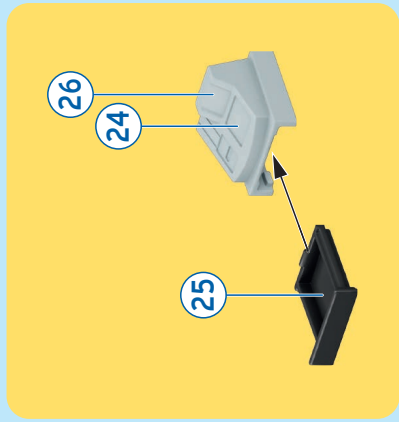

26

24

25



30

3x



31

2x

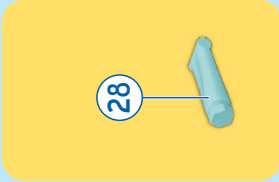

28



2x

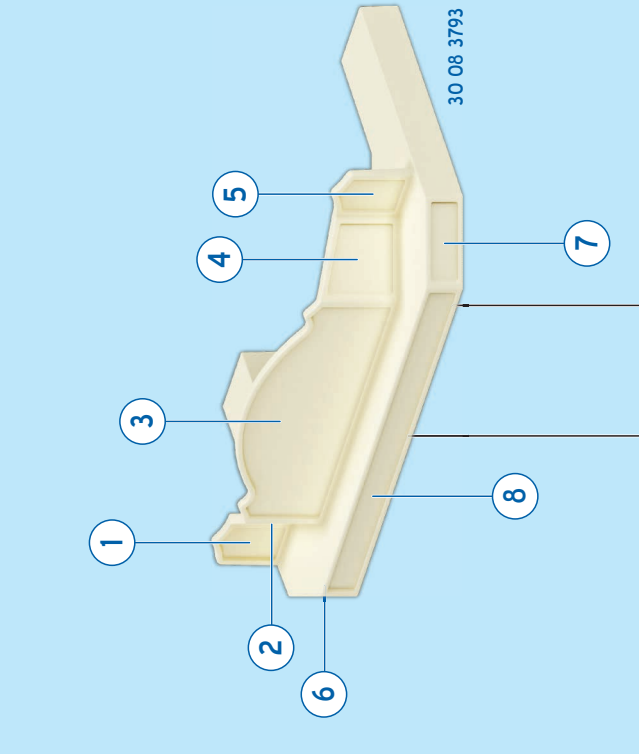
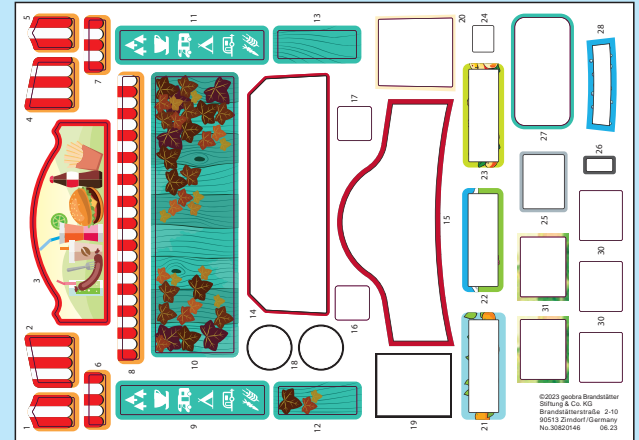

30 64 7368

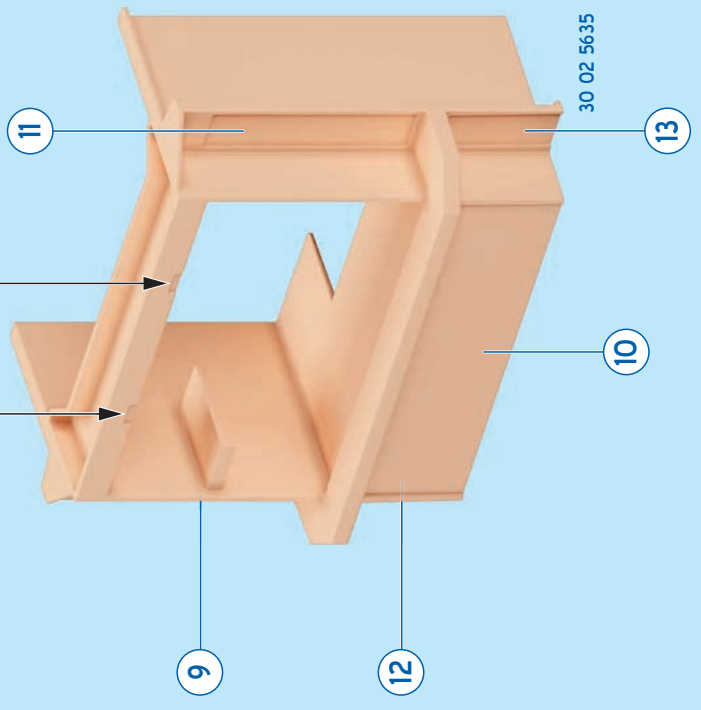
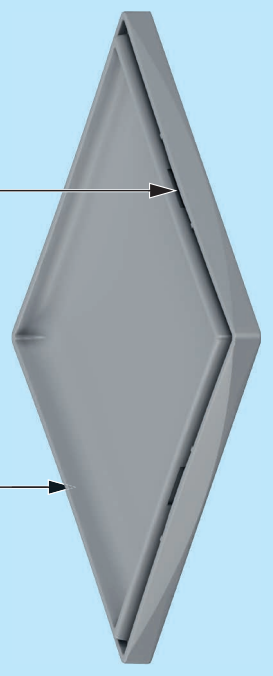
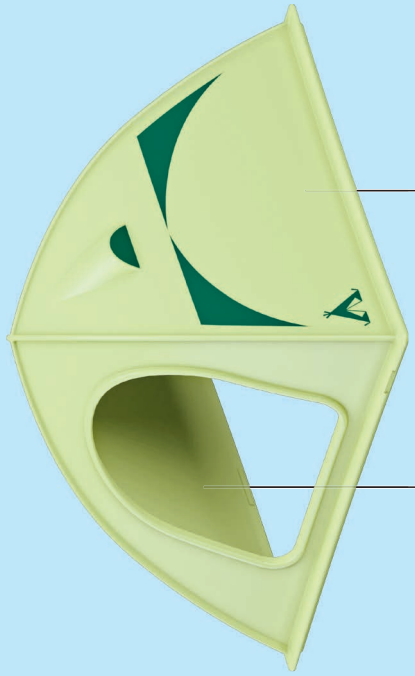

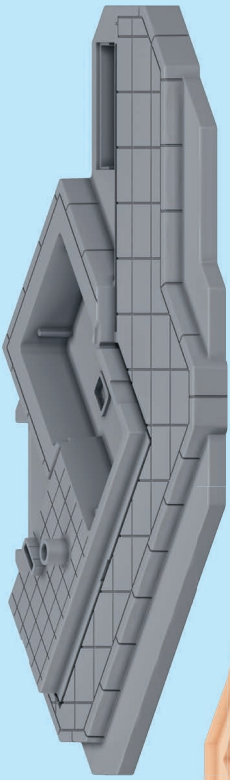

30 03 7905



30 02 5655



30 45 2723



30 02 5665



30 45 2343

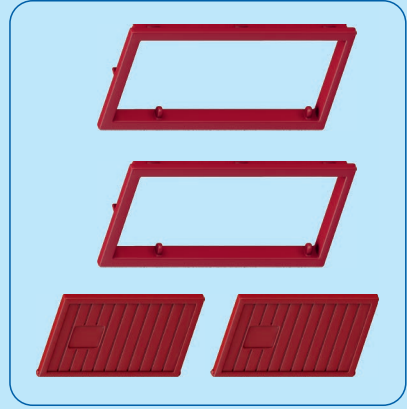

30 51 5373

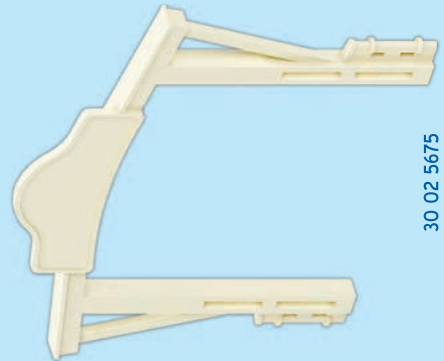

30 02 5675



30 82 0156



30 80 6823



30 80 7553

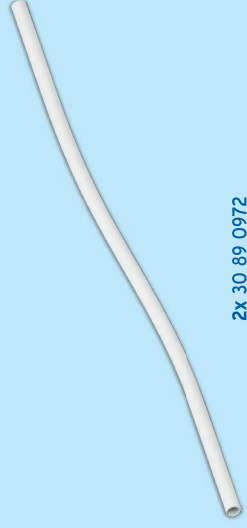

2x 30 89 0972

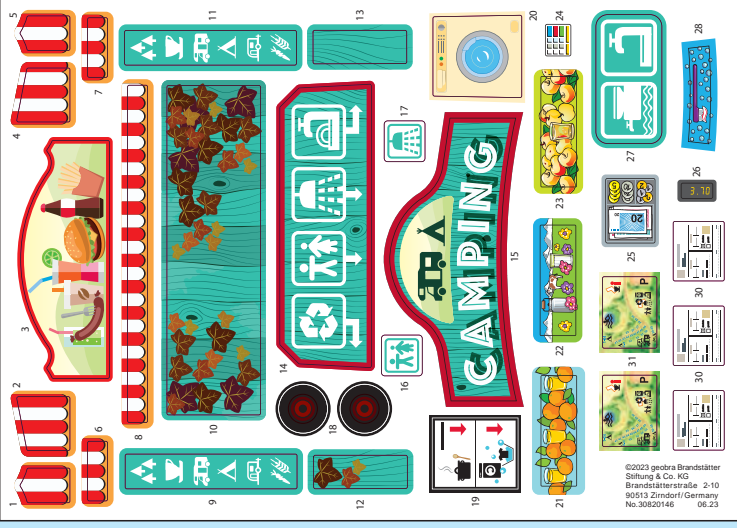

30 82 0146



30 14 4802



30 00 5125



30 10 5630



30 51 3880



30 51 0062



30 22 7110



30 22 5950



30 22 5800



30 25 0143



30 63 6082



30 03 1233



30 51 0072



30 03 1893

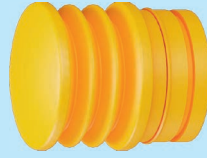

30 89 0962



30 20 0980

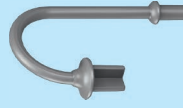

2x 30 25 1553



30 25 1633



30 03 1883



2x 30 25 1653

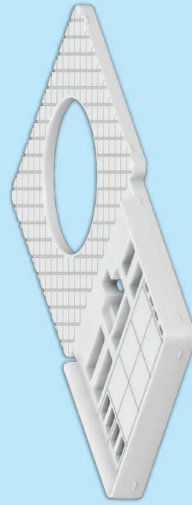

30 25 1673



2x 30 21 4422



2x 30 28 7640



30 21 4662



30 25 1723



30 25 2053



30 21 4972

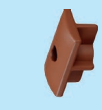

3x 30 25 1623



30 25 2063



2x 30 25 1563



30 09 6900



30 28 1950



2x 30 03 1903



2x 30 23 0460



4x 30 25 2820



5x 30 25 2810



2x 30 06 8463



4x 30 02 5685



2x 30 22 5932



2x 30 02 5705



30 22 5900



30 02 5695



30 07 9652



30 03 1863



30 26 7400



30 60 2432



30 26 7410



30 28 4430



30 62 6063



2x 30 08 3920



3x 30 23 7862



30 24 2432



30 08 4063



30 27 4260

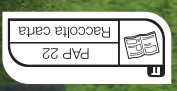

71423



71424



71426



71427



71428

