

playmobil®

COLOR



WASHABLE
ULTRA
LAVABLE

5x

Crayola

71372

Bring Farbe ins Spiel mit PLAYMOBIL Color



Entdecke deine künstlerische Seite mit PLAYMOBIL Color. Werde selbst zum Designer mit den neuen Spielsets von PLAYMOBIL Color. Nimm den Stift zur Hand und gestalte deine PLAYMOBIL-Figur ganz nach deinen Vorstellungen. Farben, Formen, Texte, Muster, alles ist möglich. Die weiße Grundfigur lässt maximalen Spielraum für alle kreativen Ideen. Und das Beste ist, deine Figur ist garantiert einzigartig!

Bring colour into play with PLAYMOBIL Color

Discover your artistic side with PLAYMOBIL Color. Become a designer with the new play sets from PLAYMOBIL Color. Pick up the marker and design your PLAYMOBIL figure however you like. Colours, shapes, texts, patterns, everything is possible. The basic blank figure gives you maximum scope for all your creative ideas. And the best thing is, your figure is guaranteed to be unique!



playmobil®
COLOR

Colorez le monde avec PLAYMOBIL Color

Dévoilez votre côté artistique avec PLAYMOBIL Color ! Devenez designer avec les nouveaux sets PLAYMOBIL Color et personnalisez votre figurine PLAYMOBIL selon votre créativité. Couleurs, formes, textes, motifs, tout est possible ! Notre célèbre figurine blanche attend votre créativité artistique pour la rendre unique !

¡Dale color al juego con PLAYMOBIL Color!

Descubre tu lado artístico con PLAYMOBIL Color. Conviértete en diseñador/a con los nuevos sets de juego de PLAYMOBIL Color. Coge el bolígrafo y diseña tu figura PLAYMOBIL con colores, formas, textos y patrones. ¡Lo mejor es que tu figura es única!





Jedes Spielset enthält eine weiße PLAYMOBIL-Figur und Filzstifte zum Bemalen. Durch ihre breite Malspitze sind Crayola Ultra Clean-Stifte kinderleicht aufzutragen. Egal ob große Flächen oder dünne Linien – Crayola-Stifte liefern mit ihren lebendigen Farben immer ein perfektes Ausmalergebnis. Und falls doch mal was danebengeht, sind die Farben ganz leicht aus- und abwaschbar. Ran an die Stifte.

Leg los und erwecke den Künstler oder die Künstlerin in dir!



Each play set contains a blank PLAYMOBIL figure and markers for colouring. Thanks to their wide tip, Crayola Ultra Clean markers are child's play to apply. Whether large areas or thin lines, Crayola markers always deliver a perfect result with their lively colours. And if something does go wrong, they can be easily washed off and start again.

Go ahead and awaken the artist in you!



Chaque set de jeu contient une figurine PLAYMOBIL blanche et des marqueurs. Les crayons Crayola Ultra Lavables sont faciles à utiliser pour les enfants. Pour colorier ou tracer des traits, les crayons Crayola offrent toujours un résultat parfait avec leurs couleurs vives. Les couleurs peuvent facilement être lavées et on peut recolorier à l'infini.

A vous les feutres et réveillez l'artiste qui est en vous !



Cada playset contiene una figura PLAYMOBIL blanca y marcadores para colorear, Crayola Ultra Clean. Ya sean grandes áreas o líneas finas, los marcadores Crayola siempre ofrecen un resultado de coloreado perfecto con sus vivos colores. Y si algo sale mal, los colores se pueden lavar y borrar fácilmente.

¡Adelante, despierta al artista que llevas dentro!



Mit abwaschbaren, giftfreien Crayola-Stiften.
Includes Crayola non-toxic washable markers.
Comprend des marqueurs non toxiques lavables Crayola.
Incluye marcadores lavables no toxicos Crayola.

Schnell trocknende Farben für ein
sauberes Spielerlebnis

Fast drying colors provide
clean handling

Manipulation propre avec des
encres à séchage rapide

Fácil manipulación y secado rápido

Für endlose Kreativität und Spielspass!
Einfach abwaschen und neu bemalen!

Enjoy endless creativity and
fun! Wash off and color again!

Couleur creative et plaisir sans
fin! Laves et colorier a nouveau!

¡Creatividad y diversión sin fin!
¡Limpia y vuelve a colorear!



EINFACH ABWASCHBAR VON...
EASY TO WASH FROM...
FACILE À LAVER DE...
FÁCIL DE LIMPIAR DE...



KLEIDUNG
CLOTHES
VÊTEMENTS
ROPA



HÄNDEN
HANDS
MAINS
MANOS



WÄNDEN
WALLS
MURS
PARED



WARNING: CHOKING HAZARD

Small parts. Not for children under 3 years.

"Ne concerne que les USA"

Wichtige Unterlagen, bitte sorgfältig aufbewahren!
Important: Please keep these instructions for future reference!
Documents importants, à conserver soigneusement!
¡Por favor, guarde estas instrucciones para el futuro!
Belangrijke documenten, bewaar deze zorgvuldig!

Abbildungen können vom Original abweichen.
Product may differ from image shown.
Les illustrations peuvent différer de l'original.
Las ilustraciones pueden diferir del original.
Afbeeldingen kunnen verschillen van het
werkelijke artikel.

Serviceadressen finden Sie in allen
PLAYMOBIL-Prospekten

Addresses of Customer Service Depart-
ments are shown in all PLAYMOBIL
catalogues

L'adresse du service consommateurs
est indiquée dans tous les catalogues
PLAYMOBIL

Troverete gli indirizzi dei centri di
assistenza in tutti i cataloghi PLAYMOBIL

In alle PLAYMOBIL catalogi vindt u
het adres van onze klantendienst.

Las Direcciones de los Departamentos
de Servicio al Consumidor se encuentran
en todos los catálogos PLAYMOBIL

Η διεύθυνση του Γραφείου Εξυπηρέτησης
Καταναλωτών PLAYMOBIL βρίσκεται σε
όλους τους καταλόγους PLAYMOBIL.

pronounced: plāymō-bēel

UK-Importer:
Playmobil UK Ltd.
Regency House
1 Miles Gray Road
Basildon
Essex
SS14 3RW
UK

UK
CA

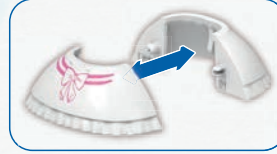

30 64 3478

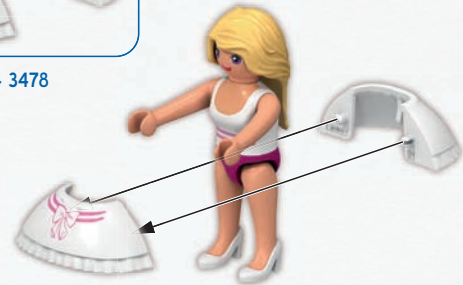

30 14 7782



30 60 5022



30 09 2183

30 24 5983

30 14 4602

30 60 0732

1

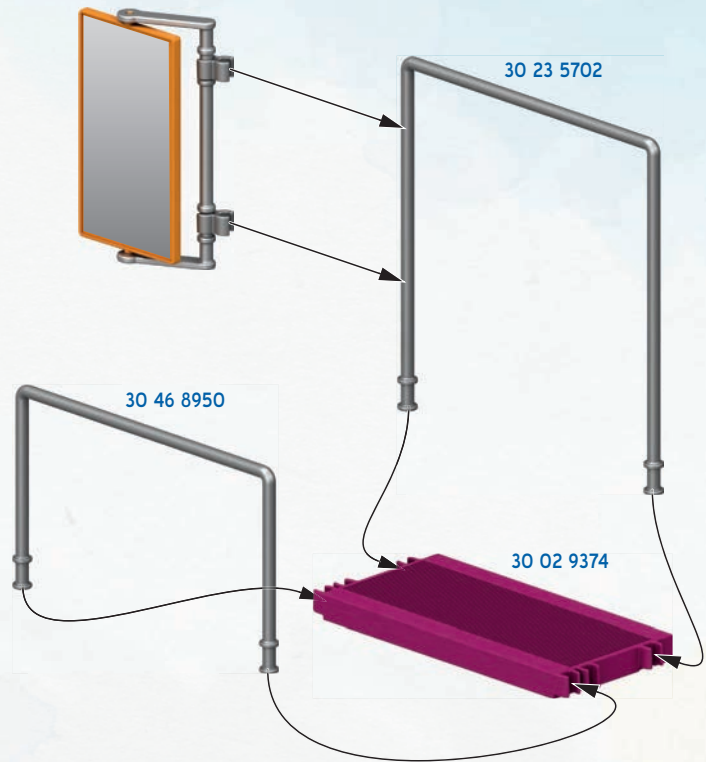
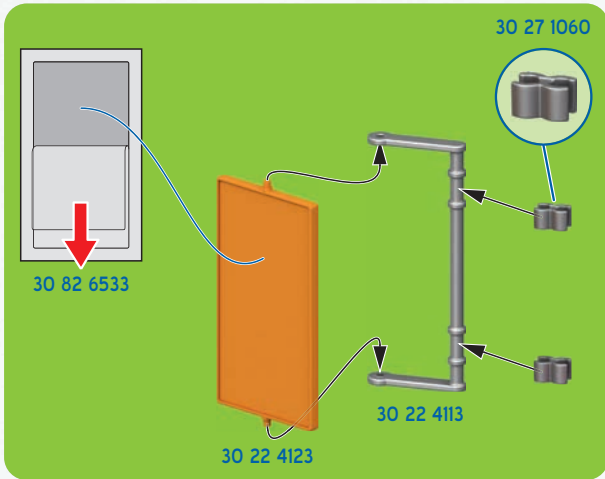

2

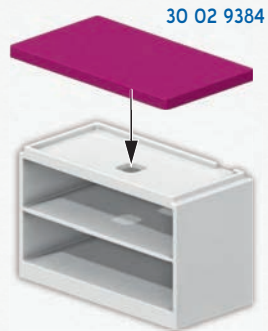
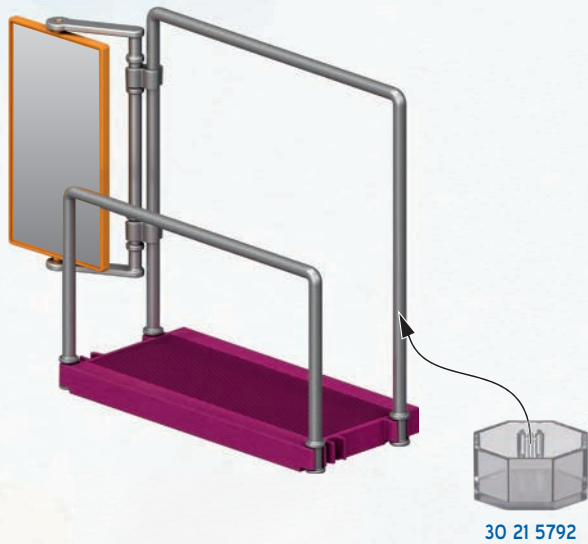

30 20 8400

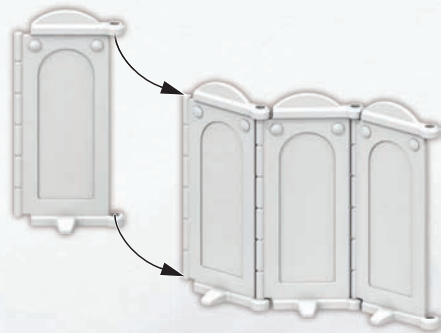

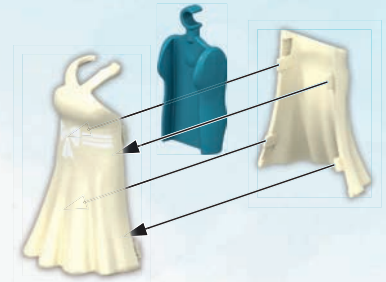

30 64 3468

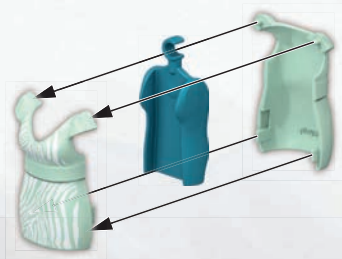

30 60 0173

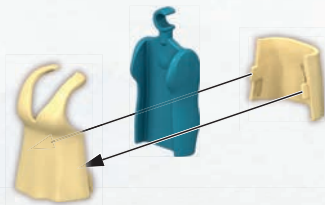

30 66 1366

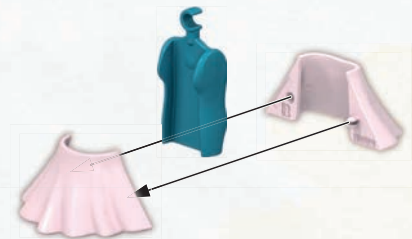



30 06 2593



30 25 3090

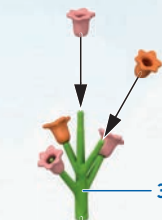

30 09 2110



30 20 5540



30 04 7812



30 64 5432

30 22 0332

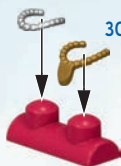

30 02 9294

30 03 2514



30 24 5913



30 24 5903

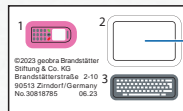

30 81 8785

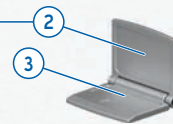

30 67 0232



30 24 6033



30 09 2033



30 22 5423



30 09 2023



30 08 6423

30 07 3840



30 64 3498



30 02 9394



30 20 5030



30 80 1640



30 64 3488



30 63 2934



30 02 2714



30 20 9762



30 09 5923



30 20 0864



30 24 5983



2x 30 27 4270



30 81 8695



30 81 8685



30 81 8705



30 81 8675



30 81 8665

<p>ACMI AP ASTM D 4236</p>	SAFETY INFORMATION RENSEIGNEMENTS SUR LA SECURITE
	All Crayola art materials are nontoxic.
	Tout le matériel d'artiste Crayola est non toxique.

WASHING & CARE • LAVAGE ET ENTRETIEN

FOR BEST RESULTS: Crayola Ultra-Clean Washable Markers wash from skin, most washable clothing and most surfaces. Wash promptly in cold or hot wash cycle. Do not use prewash or chlorine bleach. Repeat laundering may be required. Remove marks from all surfaces as soon as possible.

STAIN ADVISEMENT: Keep away from wallpaper, finished and unfinished wood, vinyl, carpeting and other materials that cannot be laundered.

POUR LES MEILLEURS RÉSULTATS : Les marqueurs ultra-lavables Crayola se lavent de la peau, de la plupart des vêtements lavables et de la majorité des murs peints. Laver promptement au cycle d'eau froide ou chaude. Ne pas utiliser d'agent de pré-lavage ni d'agent de blanchiment au chlore. Plus d'un lavage peut être nécessaire.

ATTENTION AUX TACHES : Tenir à l'écart du papier peint, des murs peints, du bois fini et non fini, du vinyle, des tapis et d'autres matériaux non lavables.

playmobil®

COLOR



71372



71374



71377



71373



71376

© 2023 Crayola, Easton, PA 18044-0431. CRAYOLA® and all associated trademarks and logos are owned by Crayola and used under license.



FR **DONNEZ**
OU
RECYCLEZ



LIVRAISON MAGASIN ASSOCIATION DÉCHÈTERIE



Adresses sur quefairedemesdehets.fr

©2023 geobra Brandstätter Stiftung & Co. KG
Brandstätterstr. 2-10 • 90513 Zimndorf, Germany • No. 30820126