

playmobil®

WILTOPIA



71293

WILTOPIA



SCAN MICH
SCAN ME
SCANNEZ-MOI
ESCANEA

DIE WELT KENNEN UND LIEBEN LERNEN.
GET TO KNOW AND LOVE THE WORLD.
APPRENDRE À CONNAÎTRE ET À AIMER LE MONDE.
CONOCER Y AMAR EL MUNDO.

*Wiltopia Produkte: im Schnitt zu über 80% mit recycelten und biobasierten Materialien.
*Wiltopia Products: With more than 80% recycled and bio based materials on average.
*Gamme Wiltopia avec plus de 80% de matériaux recyclés et biosourcés en moyenne.
*Productos wiltopia: con una media de más del 80% de materiales reciclados y biológicos.

HINWEIS
Note notice
Atención



Aufbauen leicht gemacht mit nummerierten Tüten.
Viel Spaß mit deinem neuen PLAYMOBIL-Spielzeug!

Set-up made easy with numbered bags.
Have fun with your new PLAYMOBIL toy!

Simplicité de montage avec les sachets numérotés.
Amuse-toi avec tes nouveaux PLAYMOBIL!

El montaje es más fácil con
las bolsas numeradas.
¡Diviértete con tu nuevo
juguete de PLAYMOBIL!





WARNING: CHOKING HAZARD

Small parts. Not for children under 3 years.

"Ne concerne que les USA"

Wichtige Unterlagen, bitte sorgfältig aufbewahren!
Important: Please keep these instructions for future reference!
Documents importants, à conserver soigneusement!
¡Por favor, guarde estas instrucciones para el futuro!
Belangrijke documenten, bewaar deze zorgvuldig!

Abbildungen können vom Original abweichen.
Product may differ from image shown.
Les illustrations peuvent différer de l'original.
Las ilustraciones pueden diferir del original.
Afbeeldingen kunnen verschillen van het werkelijke artikel.

Serviceadressen finden Sie in allen
PLAYMOBIL-Prospekten

Addresses of Customer Service Depart-
ments are shown in all PLAYMOBIL
catalogues

L'adresse du service consommateurs
est indiquée dans tous les catalogues
PLAYMOBIL

Troverete gli indirizzi dei centri di
assistenza in tutti i cataloghi PLAYMOBIL

In alle PLAYMOBIL catalogi, vindt u
het adres van onze klantendienst.

Las Direcciones de los Departamentos
de Servicio al Consumidor se encuentran
en todos los catálogos PLAYMOBIL

Η διεύθυνση του Γραφείου Εξυπηρέτησης
Καταναλωτών PLAYMOBIL βρίσκεται σε
όλους τους καταλόγους PLAYMOBIL.

pronounced: play-mō-beē

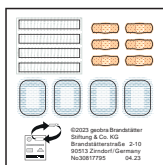



(DE) (AT) (CH) (LU) (BE) repositionierbar
 (US) (GB) (CA) (MT) (IE) repositionable
 (FR) (CA) (BE) (LU) (CH) repositionnable
 (ES) (MX) reposicionable
 (NL) (BE) herpositioneerbaar
 (IT) (CH) riposizionabile

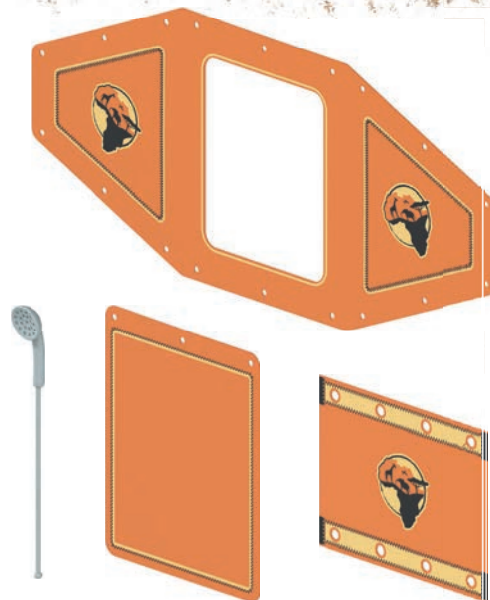
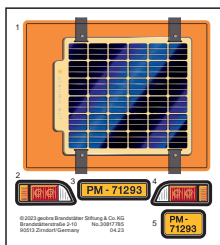

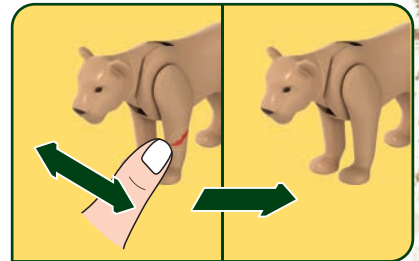

1



+

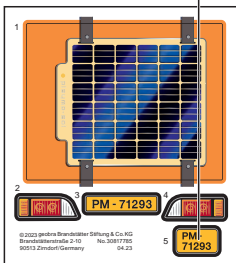

2

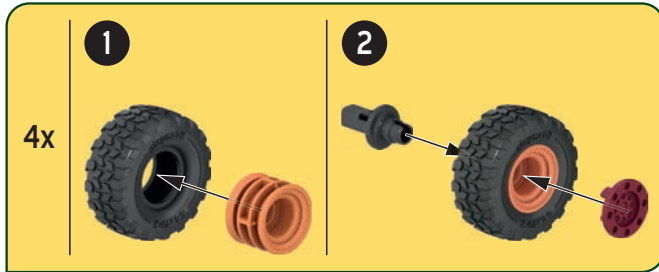

3



4

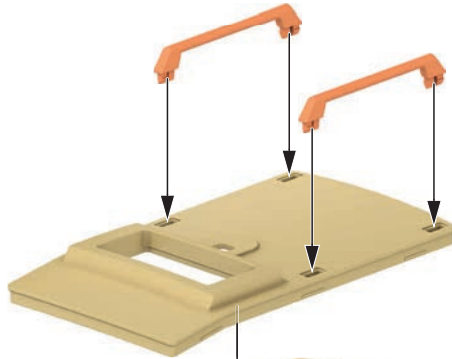

5

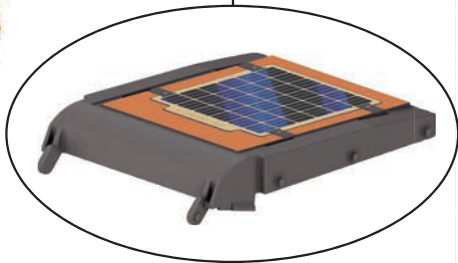
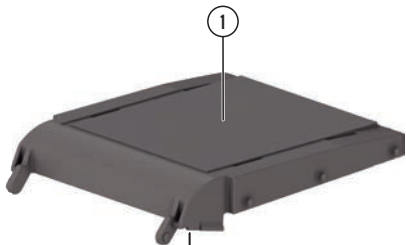
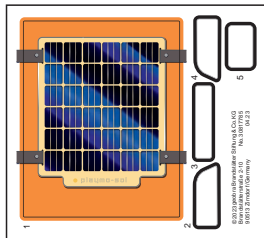

6



7



8

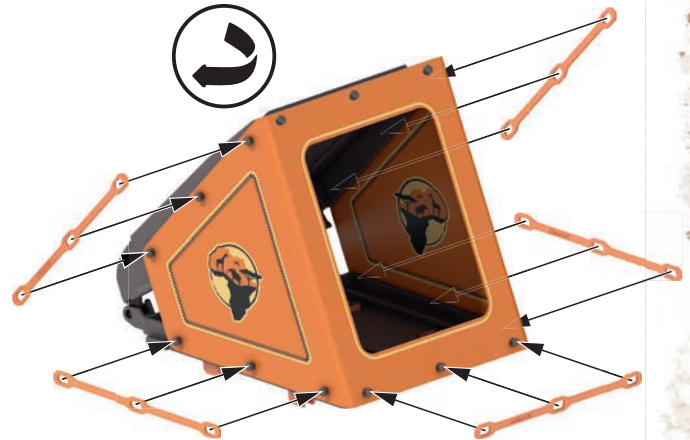

9



10



11

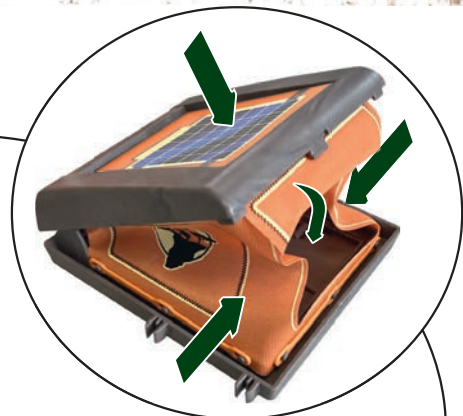

12

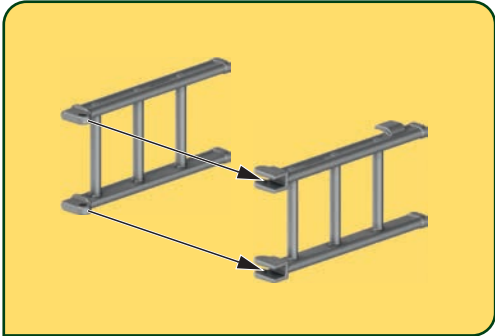

oder
or
ou



13

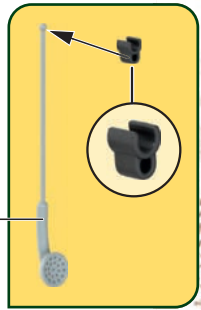
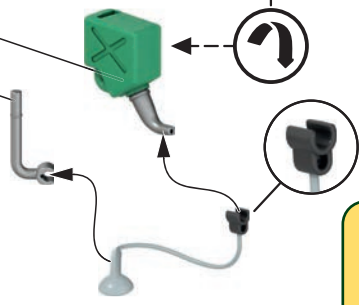
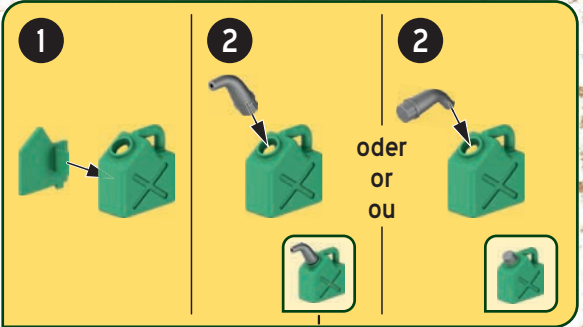

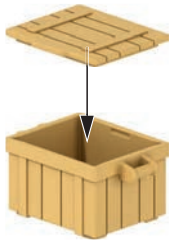
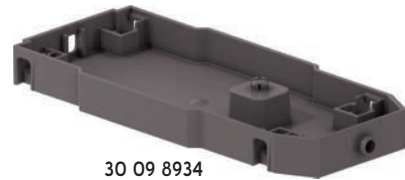
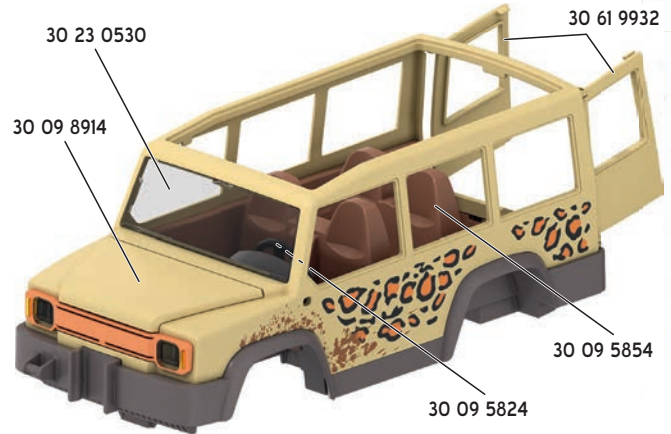
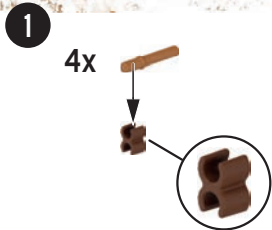



1

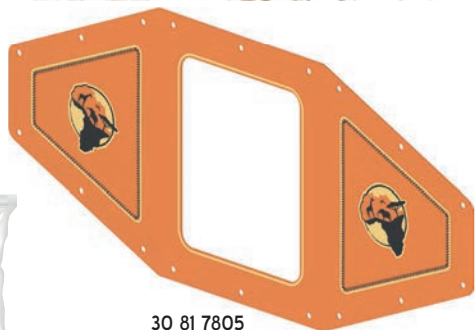

30 81 7805



30 81 7815



30 81 7825



30 25 1243

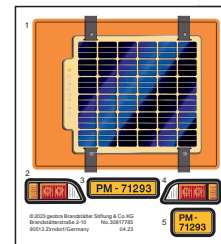

30 81 7785

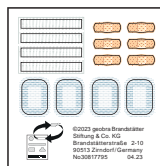

30 81 7795



30 81 7835



30 51 5073



2



30 00 4645



30 09 8964



30 09 8984



30 64 1538



2x 30 09 8954



30 09 8944



30 06 3494



30 09 8974



30 06 9294



30 00 4655



30 65 9605



30 65 9595



30 82 3645



30 09 9054



30 06 3474



30 09 9074



30 09 9044



30 64 1588



2x 30 09 9084



4x 30 82 4023



30 51 3823



4x 30 82 4710



4x 30 09 9184



4x 30 09 9194



4x 30 09 9174



2x 30 09 9164



30 09 9144



30 51 5123



30 51 5113



30 51 5103



2x 30 09 9224



2x 30 09 9204



6x 30 09 9214



30 09 9304



30 09 9254



30 09 9274



2x 30 09 9324



4x 30 08 1984



30 09 9294



2x 30 09 9234



30 09 9244



30 09 9264



30 60 0023



30 09 9284



4x 30 09 9314

UK-Importer:
Playmobil UK Ltd.
Regency House
1 Miles Gray Road
Basildon
Essex
SS14 3RW
UK



Achtung: RC-Modul-Set
(Art. Nr. 6914) nicht enthalten!
Please note: RC module set
(Art. No. 6914) is not included!
Attention : Le Module de radio-
commande Plus (art. 6914)
n'est pas inclus.

¡Atención: Set módulo RC
(n.º art. 6914) no incluido!

Atenção: Set módulo RC Plus
(art. 6914) não incluído!

Attenzione: la confezione
non contiene il radiocomando
RC (num. art. 6914).

Let op: Afstandsbedieningsset RC Plus
(art. nr. 6914) niet inbegrepen!

ΠΡΟΣΟΧΗ! ΔΕΝ ΠΕΡΙΛΑΜΒΑΝΕΤΑΙ
ΤΟ ΣΥΣΤΗΜΑ ΤΗΛΕΧΕΙΡΙΣΜΟΥ
(ΚΩΔ. 6914)

Uwaga: brak modułu zdalnego
sterowania (Nr.art. 6914)!

ご注意: 本体には、RCモジュールセット
(No. 6914)は含まれておりません。

71293 + 6914

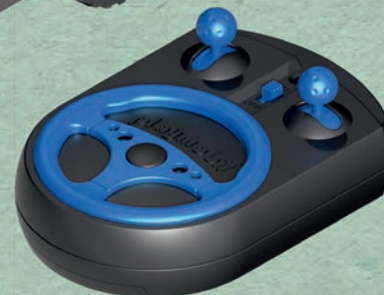

rc-modul.playmobil.com

1



2

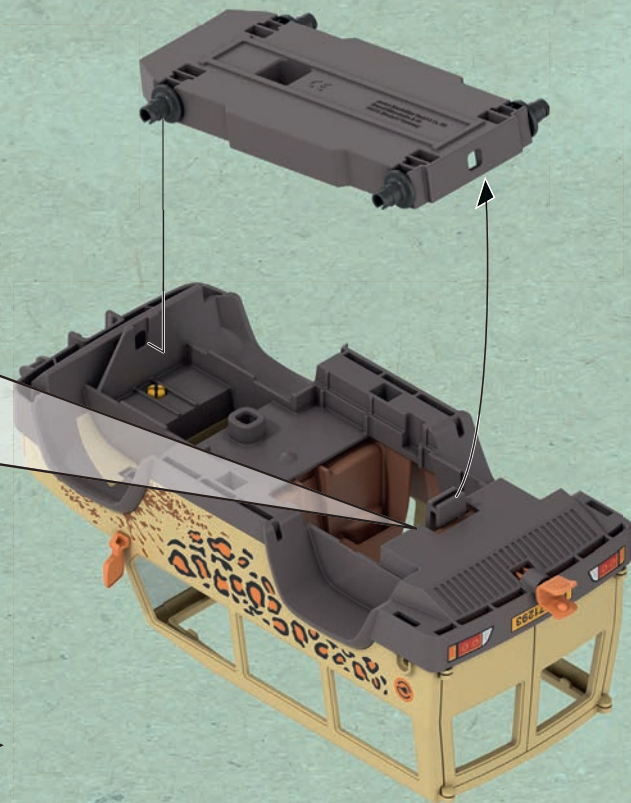
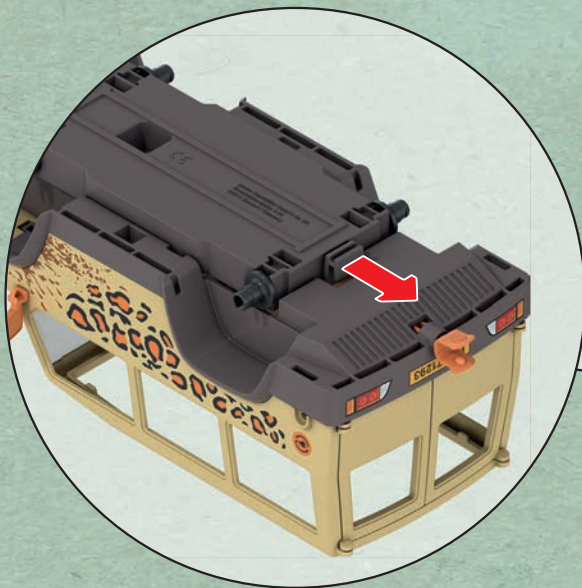

3

1

4x MIGNON 1.5V
R6 · LR6 · AA

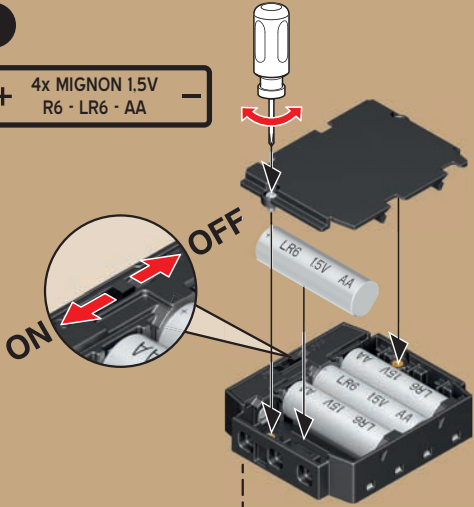

2

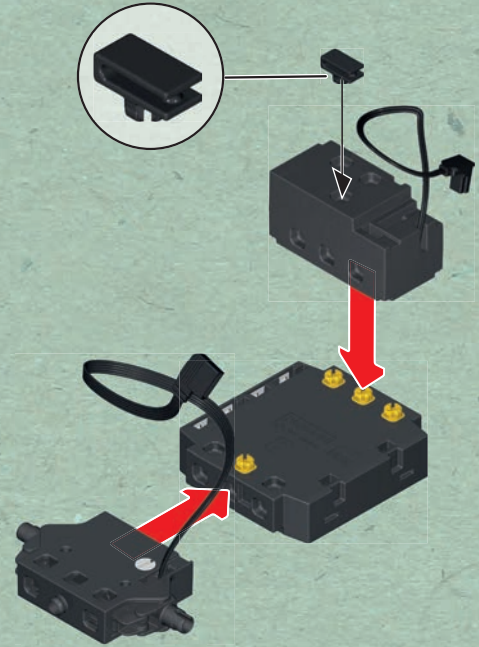
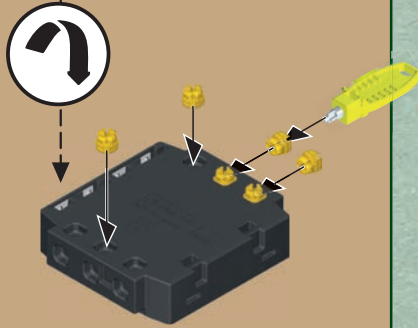

4

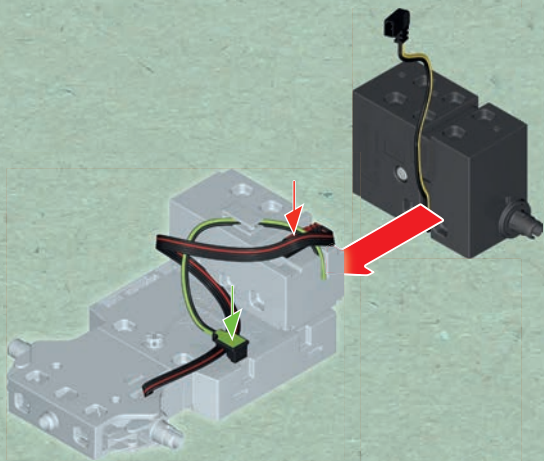

5

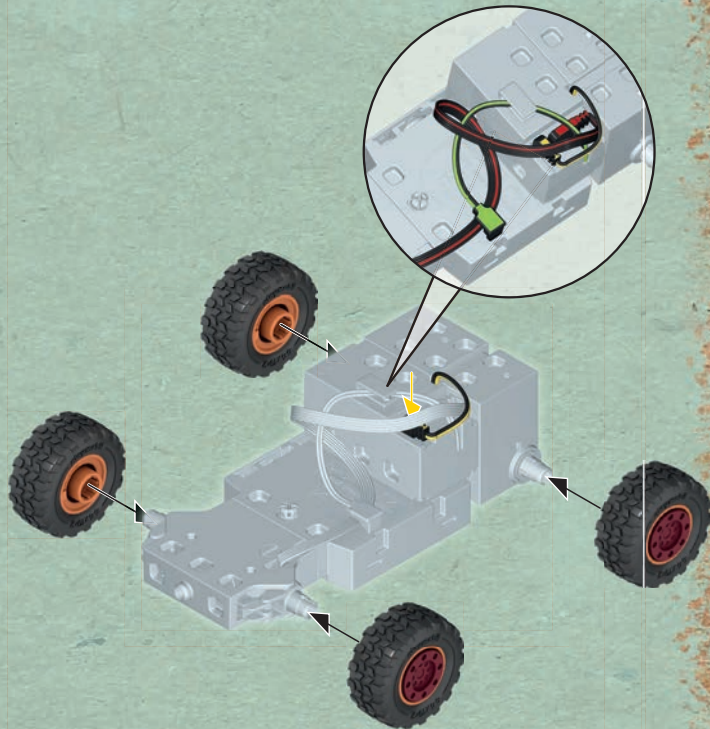

6

CLICK

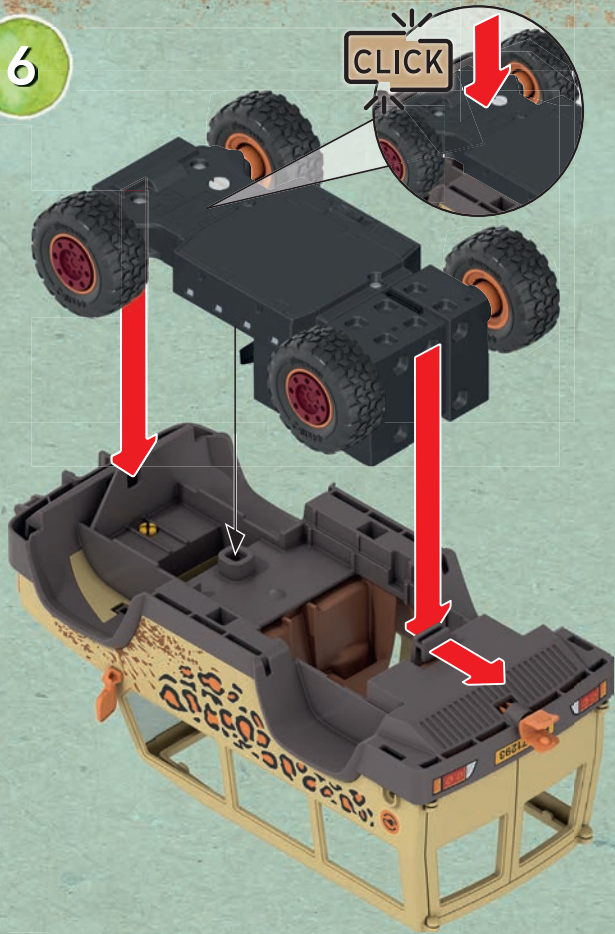

7

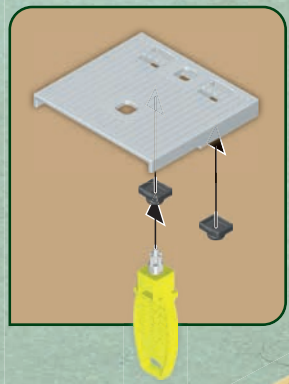

8

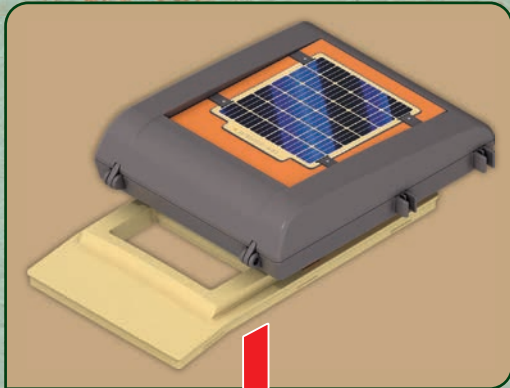

FR
DONNEZ
OU
RECYCLEZ

ASSOCIATION OU MAGASIN
LIVRAISON OU DÉCHÈTERIE

Adresses sur quefairedemesdechets.fr



DE AT CH LU BE Nur angegebene Batterien verwenden. Nicht wiederaufladbare Batterien dürfen nicht geladen werden. Aufladbare Batterien dürfen nur unter Aufsicht von Erwachsenen geladen werden. Aufladbare Batterien sind aus dem Spielzeug herauszunehmen, bevor sie geladen werden. Ungleiche Batterietypen oder neue und gebrauchte Batterien dürfen nicht zusammen verwendet werden. Batterien müssen mit der richtigen Polarität eingelegt werden. Leere Batterien müssen aus dem Spielzeug herausgenommen werden. Die Anschlussklammern dürfen nicht kurzgeschlossen werden. Batterien regelmäßig auf Auslaufen überprüfen. Verbrauchte Batterien nicht in den Hausmüll werfen, sondern nur bei den bestehenden Sammelstellen oder einem Sondermüllplatz abgeben.

US GB CA MT IE Only use the stipulated batteries. Non-rechargeable batteries are not to be charged. Rechargeable batteries are only to be charged under adult supervision. Rechargeable batteries are to be removed from the toy before they are recharged. Neither different battery types nor new and used batteries are to be used together. Batteries must be inserted with the correct polarity. Flat batteries are to be removed from the toy. The connecting terminals are not to be short-circuited. Inspect batteries regularly for signs of leakage. Do not dispose of used batteries in the household waste but hand them in at the existing collection points or at a special waste site.

FR CA BE LU CH Seulement utiliser le modèle de piles indiqué. Ne pas recharger de piles non rechargeables. Seulement recharger des piles rechargeables en présence d'adultes. Ôter les piles rechargeables du jouet avant de les recharger. Ne pas utiliser de piles de différents types en même temps ni de piles neuves avec des piles anciennes. Attention à introduire correctement les piles en tenant compte de leur polarité. Ôter les piles usées du jouet. Ne pas court-circuiter les bornes. Vérifier régulièrement si les piles coulent. Ne pas jeter de piles usées avec les ordures ménagères, les déposer dans les centres de récupération.



FR
Cet appareil se recycle

À DÉPOSER EN MAGASIN ou À DÉPOSER EN DÉCHÈTRIE

Points de collecte sur www.quefairede mesdechets.fr
Privilegiez la réparation ou le don de votre appareil!

ES MX Utiliza únicamente las pilas descritas. No recargues únicamente bajo supervisión de un adulto. Saca las pilas recargables del juguete antes de recargarlas. No utilices juntas pilas de tipos diferentes ni tampoco pilas nuevas con pilas usadas. Inserta las pilas con la polaridad correcta. Saca del juguete las pilas gastadas. No pongas en cortocircuito los bornes de conexión. Comprueba periódicamente si se ha producido una fuga en las pilas. No eches las pilas gastadas a la basura doméstica, deséchalas únicamente en los puestos de recogida previstos o en un depósito de basura especial.

NL BE Uitsluitend de aangegeven batterijen gebruiken. Niet-herlaadbare batterijen mogen niet geladen worden. Herlaadbare batterijen mogen alleen onder toezicht van volwassenen geladen worden. Opladbare batterijen moeten uit het speelgoed genomen worden vooraleer ze te laden. Ongelijke batterijtypes of nieuwe of gebruikte batterijen mogen niet samen gebruikt worden. Batterijen moeten met de correcte polen ingelegd worden. Lege batterijen moeten uit het speelgoed genomen worden. De aansluitingsklammern mogen niet kortgesloten worden. Regelmatig controleren of de batterijen niet uitgelopen zijn. Lege batterijen niet met het huisvuil verwijderen, maar alleen bij bestaande verzamelcentra of een plaats voor bijzondere afval afgeven.



IT CH Usare solo le batterie indicate. E' vietato utilizzare le batterie ricaricabili. Le batterie ricaricabili devono essere caricate soltanto in presenza di adulti. Le batterie ricaricabili si estraggono dal giocattolo, prima di essere caricate. I tipi di batteria non uguali o nuovi e le batterie esauste non devono essere usate insieme. Le batterie vanno inserite rispettando la corretta polarità. Le batterie esaurite devono essere rimosse dal giocattolo. I morsetti di collegamento non devono essere messi in corto circuito. Verificare ad intervalli regolari che le batterie non si siano esaurite. Le batterie esauste non vanno smaltite insieme ai rifiuti domestici, bensì portate nei punti di raccolta o nei centri di raccolta per rifiuti speciali.

PT Usar apenas as pilhas indicadas. Pilhas não recarregáveis não podem ser carregadas. Pilhas recarregáveis só podem ser carregadas sob supervisão de adultos. Pilhas recarregáveis devem ser retiradas do brinquedo, antes de serem carregadas. Não se pode usar em conjunto diferentes tipos de pilha ou pilhas novas e usadas. Pilhas têm de ser inseridas com a polaridade correcta. Pilhas vazias têm de ser retiradas do brinquedo. Não se podem curto-circuitar os terminais. As pilhas têm de ser controladas regularmente quanto a vazamento. Não deitar pilhas gastas no lixo doméstico, mas depositá-las nos pontos de recolha existentes ou entregá-las no estabelecimento que as comercializa.

DK Anvend kun de angivne batterier. Ikke genopladelige batterier må ikke oplades. Genopladelige batterier må kun oplades under opsyn af voksne. Genopladelige batterier skal tages ud af legetøjet, inden de oplades. Forskellige batterityper eller nye og brugte batterier må ikke anvendes sammen. Batterier skal sættes med den rigtige polaritet. Tomme batterier skal tages ud af legetøjet. Tilslutningsklammerne må ikke kortsluttes. Kontrollér regelmæssigt batterierne for lækage. Obrugte batterier må ikke bortskaffes som almindeligt husholdningsaffald, men skal afleveres på et officielt sted for indsamling af brugte batterier eller på den kommunale genbrugsstation.

NO Benytt kun angitte batterier. Batterier som ikke kan gjenoplades må ikke lades opp. Opladbare batterier må bare lades opp under tilsyn av voksne. Opladbare batterier må tas ut av leketøyet før de lades opp. Ulike batterityper eller nye og brukte batterier må ikke benyttes sammen. Batterier må legges inn med riktig polaritet. Tomme

batterier må tas ut av kjoretøyet. Koplingsklammerne må ikke kortsluttes. Kontrollér batteriene regelmessig for om de lekker ut. Ikke kast oppbrukte batterier i husholdningsaffallet, men lever dem til lokale miljøstasjoner eller til en plass for spesialavfall.

SE FI Använd endast angivna batterier. Batterier som inte är uppladdbara får inte laddas. Uppladdbara batterier får endast laddas om en vuxen person hjälper dig. Ta ur de uppladdbara batterierna ur fordonet innan de laddas. Använd inte olika batterityper samtidigt, använd heller inte ett nytt och ett gammalt batterie samtidigt. Se till att batterierna ligger åt rätt håll, det finns symboler på batterierna och i batterifacket. Ta ur tomma batterier ur leksaken. Lagg inte ihop anslutningsklammerna, de kan bli kortslutning. Kontrollera regelbundet att batterierna inte läcker batterisyra. Gamla batterier hör inte hemma i vanliga hushållsopor. Kasta batterier i speciella batteriuppsamlare eller lämna dem till soptippen som specialavfall.

FI Käytä vain ilmoitettuja paristoja. Ei saa ladata paristoja, jotka eivät ole ladattavia. Ladattavat paristot saa ladata vain aikuisen valvonnassa. Ladattavat paristot on poistettava leikkikalusta ennen lataamista. Erilaisia paristotyyppejä tai uusia ja käytettyjä paristoja ei saa käyttää yhdessä. Paristot on asetettava paikoilleen navat oikein päin. Tyhjät paristot on poistettava leikkikalusta. Liittimen osikoulu ei ole sallittua. Tarkista säännöllisesti, että paristot eivät vuoda. Älä heitä käytettyjä paristoja talousjätteeseen, vain toimita ne vain asiankuuluvien keräyspisteisiin tai ongelmajätapaikkaan.

HU Csak a megadott elemeket szabad használni. A nem tölthető elemek töltése tilos. A tölthető elemeket csak felöltött felügyelet mellett szabad tölteni. A feltölthető elemeket ki kell venni a játékból a töltés előtt. Nem egyforma típusú elemek, vagy új és használt elemek együtt nem használhatók. Az elemeket a megfelelő polaritással kell behelyezni. A lemerült elemeket ki kell venni a játékból. A csatlakozó kapcsokat nem szabad rövidre zární. Rendszeresen ellenőrizni kell, hogy az elemek nem folynak-e. A használt elemeket nem szabad a háztartási szeméthez dobni, hanem le kell adni egy gyűjtőhelyen vagy veszélyes hulladék állomáson.

CZ Používejte pouze uvedené baterie. Baterie, které není možno dobíjet, nesmí být nabíjeny. Nabíjecí baterie smí být nabíjeny pouze pod dohledem dospělých osob. Nabíjecí baterie musejí být před nabíjením vyjmuty z hračky. Různé typy baterií nebo nové a použité baterie nesmí být použity společně. Je nutno vložit baterie se stejnou polaritou. Prázdné baterie je nutno z hračky vyndat. Připojovací svorky nesmí být spojeny nakrátko. Pravidelně kontrolujte, zda baterie nevytékají. Použité baterie neházte do domovního odpadu, pouze je odevzdejte na stávající sběrná místa nebo stanovité pro nebezpečný odpad.

EE Kasutage ainult lubatud patareid. Laadimisvõimaluseta patareid ei ole keelatud laadida. Laadimisvõimalusega patareid võib laadida ainult täiskasvanu või isik, kellel on selleks aeg. Laadimisvõimalusega patareid tuleb enne laadimise alustamist märguasia seest välja võtta. Ärge kasutage korraga erinevat tüüpi või uusi ja kasutatud patareid. Jälgige patareide paigaldamisel õiget polaarsust. Tühjad patareid tuleb märguasia seest välja võtta. Ühendusklemmide lühistamine on keelatud. Kontrollige patareid regulaarselt, et nad ei eraldaks vedelikku. Ärge visake

<p>kasutuskõlbmatuid patareisid majapidamisrugi hulka, vaid andke need vastavatesse kogumiskohtadesse või ohlikke jäätmete kogumispunktidesse.</p>	<p>nie wyciekają. Zużytych baterii nie wyrzucać do kosza na śmieci, tylko oddać w odpowiednich punktach zbiórki lub wrzucić do przeznaczonych do tego celu specjalnych pojemników.</p>	<p>(HR) Koristiti samo navedene baterije. Baterije za ponovno punjenje se ne smiju koristiti. Baterije za ponovno punjenje se smiju puniti samo pod nadzorom odraslih. Baterije za ponovno punjenje se prije punjenja moraju izvaditi iz igračke. Baterije raznih tipova ili nove i rabljene se ne smiju skupa upotrebljavati. Baterije se moraju umetnuti sa točnim polaritetom. Prazne baterije se moraju izvaditi iz igračke. Priključnice stazalje se ne smiju kratko spojati. Baterije redovito provjeravati u svezi curenja. Istrošene baterije ne bacati u kućno smeće, već ove odnijeti na postojeća sabirna mjesta ili predati na jedno mjesto za posebno smeće.</p>
<p>(LV) Izmantot tikai norādītās baterijas. Neuzlādēt baterijas, kuras nedrīkst atkārtoti uzlādēt. Uzlādējamas baterijas drīkst uzlādēt tikai pieaugušo uzraudzībā. Uzlādējamas baterijas pirms uzlādēšanas izņemt no transportlīdzekļa. Neizmantot kopā atšķirīgus bateriju tipus vai jaunas un lietotas baterijas. Ievietojot baterijas, ievērot polaritāti. Tukšas baterijas no rotatīvajām jāņem. Pieslēguma spaiļes nedrīkst saslēgt īslīgumā. Regulāri pārbaudīt, vai baterijas nav iztecējušas. Lietotas baterijas neizmet kopā ar sadzīves atkritumiem, bet gan esošajās bateriju savākšanas vietās vai speciālā atkritumu izvešanas vietā.</p>	<p>(TR) (CY) Yalnızca belirtilen pilleri kullanınız. Şarj edilemeyen piller şarj edilmemelidir. Şarj edilebilir piller yalnızca yetiskinlerin gözetiminde şarj edilmelidir. Şarj edilebilir piller, şarj edilmeden önce oyuncak içerisinde çikartılmalıdır. Türleri birbirinden farklı piller veya yeni ve eski pilleri bir arada kullanmayınız. Piller kutupları doğru olacak şekilde yerleştirilmelidir. Biten piller oyuncak içerisinde çikartılmalıdır. Bağlantı klemensleri kisa devre yapılmamalıdır. Düzenli aralıklarla pillerin atık akumilatörünü kontrol ediniz. Kullanılmış pilleri ev çöplüne atmayınız, yalnızca özel toplama yerlerine atınız veya özel atık merkezine ulaştırınız.</p>	<p>(RU) Используйте только указанные батареи. Неперезаряжаемые батареи не следует заряжать. Перезаряжаемые батареи можно заряжать только под присмотром взрослых. Перед зарядкой перезаряжаемые батареи следует извлечь из игрушки. Различные типы батареек или новые и использованные батареи не должны использоваться вместе. Батареи следует вставить с учетом правильной полярности. Разряженные батареи следует извлечь из игрушки. Не допускайте короткого замыкания соединительных клемм. Регулярно проверяйте батареи на предмет износа. Не выбрасывайте использованные батареи в бытовые отходы, а утилизируйте их только в соответствующих пунктах сбора или в месте для утилизации специальных видов отходов.</p>
<p>(LT) Naudoiti tik nurodytas baterijas. Vienkartinių baterijų įkrauti negalima. Daugkartinio naudojimo baterijos turi būti įkraunamos suaugusiųjų priežiūroje. Prieš įkraunant daugkartinio naudojimo baterijas, jas reikia išimti iš žaislo. Negalima kartu naudoti skirtingų tipų, arba naujų ir naudotų baterijų. Baterijas reikia įdėti, atsižvelgiant į teisingą poliškumą. Išsikrovusias baterijas reikia išimti iš žaislo. Negalima atlikti trumpo jungiamųjų gnybtų jungimo. Reguliariai tikrinti ar baterijos nėra išsivargę. Naudotų baterijų negalima išmesti kartu su buitinėmis atliekomis. Jas reikia atiduoti į esamas surinkimo vietas arba į pavojingų atliekų surinkimo aikštelę.</p>	<p>(GR) (CY) Να χρησιμοποιείτε μόνο μπαταρίες του τύπου που σας υποδεικνύουν οι πληροφορίες ή αντίστοιχες. Ποτέ μην επαναφορτίζετε μη επαναφορτιζόμενες μπαταρίες. Οι επαναφορτιζόμενες μπαταρίες πρέπει να επαναφορτίζονται πάντα από ενήλικα. Αφαιρέστε τις επαναφορτιζόμενες μπαταρίες από την ηλεκτρονική μονάδα του παιχνιδιού πριν τις επαναφορτίσετε. Μην συνδυάζετε μπαταρίες διαφορετικών τύπων, π.χ. αλκαλικές ή επαναφορτιζόμενες με αλκάλες, ή παλιές με καινούριες. Τοποθετείτε τις μπαταρίες με την σωστή πολικότητα. Όταν αδειάζουν οι μπαταρίες πρέπει να απομακρύνονται από το παιχνίδι. Ποτέ μη βραχυκυκλώνετε τους πόλους. Πάντα να ελέγχετε τις μπαταρίες για τυχόν διαρροές. Μην πετάτε ποτέ στα οικιακά απορρίμματα τις παλιές μπαταρίες, παρά μόνο σε ειδικούς κάδους ανακύκλωσης με την αντίστοιχη ένδειξη. Για τον κατάλληλο τρόπο ανακύκλωσης, παρακαλούμε επικοινωνήστε με τους τοπικούς φορείς.</p>	<p>(CN) 只限使用规定的电池类型。非充电电池不能充电。充电电池只能在成年人监督下充电！充电电池在充电前应该从玩具中取出。不同类型的电池或新旧电池不能混用！电池应以正确的极性放入。用尽的电池应从玩具中取出。电源端子不得短路。用过的旧电池请勿随意丢弃在家庭垃圾中，而是放入回收站或者交给特殊处理处。（说明书上含有重要信息，请保留备用）</p>
<p>(SI) Uporabljajte le navedene baterije. Baterij, ki niso namenjene za polnjenje, ni dovoljeno polniti. Baterije, ki se jih sme polniti, je dovoljeno polniti le pod nadzorom odraslih oseb. Pred polnjenjem je baterije, ki se lahko polnijo, potrebno vzeti iz igrače. Skupaj ni dovoljeno uporabljati različnih vrst baterij ali novih in rabljenih baterij. Baterije je potrebno vstaviti pravilno obrnjene – s pravilno polariteto. Prazne baterije je potrebno vzeti iz igrače. Na priključnih sponkah ni dovoljeno povzročati kratkega stika. Redno preverjajte, ali baterije ne iztekaajo. Izrabljenih baterij ne odlagajte med gospodinjinske odpadke, ampak jih oddajte na zbirnih mestih oz. na zbirališču posebnih odpadkov.</p>	<p>(RO) Se vor folosi doar bateriile specificate. Bateriile fără reincărcare nu au voie să se încarce. Bateriile reincărcabile se vor încarca doar sub supravegherea adulților. Bateriile reincărcabile se scot din jucărie înainte de încărcare. Nu este permisă utilizarea împreună a bateriilor de tipuri diferite sau a bateriilor noi cu cele vechi. Bateriile trebuie introduse cu polaritatea corectă. Bateriile descărcate trebuie scoase din jucărie. Bornele nu au voie să fie scurtcircuitate. Bateriile trebuie verificate în mod regulat să nu prezinte scurgeri. Bateriile consumate nu se aruncă la deșeurile menajere, ci se predau la centrele existente de colectare sau în locurile pentru deșeuri speciale.</p>	<p>(BG) Използвайте само посочените батерии. Непредназначени за зареждане батерии не бива да бъдат зареждани. Зареждащите се батерии трябва да бъдат зареждани само под надзора на възрастни. Зареждащите се батерии се изваждат от играчката, преди да се поставят за зареждане. Не използвайте заедно нееднакви модели батерии и нови и употребявани батерии не бива да се използват заедно. Поставяйте батерии, обръщайки внимание на правилния поляритет. Празните батерии трябва да бъдат изваждани от играчката. Свързващите клемми не трябва да бъдат давани на късо. Редовно проверявайте батериите за течове. Не изхвърляйте употребяваните батерии като домакински отпадък, а ги предавайте само на специално определените за това места или в депо за специални отпадъци.</p>
<p>(SK) Používajte len uvedené batérie. Batérie, ktoré nie sú nabíjateľné, sa nesmú nabíjať. Nabíjateľné batérie sa smú nabíjať len pod dohľadom dospelých osôb. Nabíjateľné batérie je potrebné pred nabíjaním vybrať z hračky. Nervonaké typy batérií alebo nové a použité batérie sa nesmú spoločne používať. Batérie sa musia vložiť so správnou polaritou. Prázdne batérie sa musia z hračky vybrať von. Pripojovacie svorky sa nesmú skratovať. Batérie pravidelne kontrolujte, či nevytekajú. Opatrované batérie nevyhadzujte do domového odpadu, ale ich odovzdajte na existujúcich zberných miestach alebo na skládke špeciálneho odpadu.</p>	<p>(PL) Stosować tylko wskazane baterie. Zwykłe baterie, nie nadające się do powtórnego ładowania, nie mogą być ładowane. Baterie nadające się do powtórnego ładowania (akumulatorki) mogą być ładowane tylko pod kontrolą osób dorosłych. Przed ładowaniem baterie-akumulatorki należy wyjąć z zabawki. Nie stosować równocześnie baterii różnych typów ani baterii nowych wraz z używanymi. Podczas zakładania baterii zwrócić uwagę na ich prawidłową polaryzację. Rozładowane baterie usunąć z zabawki. Nie zwierać zacisków. Regularnie sprawdzać, czy baterie</p>	<p>(CN) 只限使用规定的电池类型。非充电电池不能充电。充电电池只能在成年人监督下充电！充电电池在充电前应该从玩具中取出。不同类型的电池或新旧电池不能混用！电池应以正确的极性放入。用尽的电池应从玩具中取出。电源端子不得短路。用过的旧电池请勿随意丢弃在家庭垃圾中，而是放入回收站或者交给特殊处理处。（说明书上含有重要信息，请保留备用）</p>
<p>(PL) Stosować tylko wskazane baterie. Zwykłe baterie, nie nadające się do powtórnego ładowania, nie mogą być ładowane. Baterie nadające się do powtórnego ładowania (akumulatorki) mogą być ładowane tylko pod kontrolą osób dorosłych. Przed ładowaniem baterie-akumulatorki należy wyjąć z zabawki. Nie stosować równocześnie baterii różnych typów ani baterii nowych wraz z używanymi. Podczas zakładania baterii zwrócić uwagę na ich prawidłową polaryzację. Rozładowane baterie usunąć z zabawki. Nie zwierać zacisków. Regularnie sprawdzać, czy baterie</p>	<p>(PL) Stosować tylko wskazane baterie. Zwykłe baterie, nie nadające się do powtórnego ładowania, nie mogą być ładowane. Baterie nadające się do powtórnego ładowania (akumulatorki) mogą być ładowane tylko pod kontrolą osób dorosłych. Przed ładowaniem baterie-akumulatorki należy wyjąć z zabawki. Nie stosować równocześnie baterii różnych typów ani baterii nowych wraz z używanymi. Podczas zakładania baterii zwrócić uwagę na ich prawidłową polaryzację. Rozładowane baterie usunąć z zabawki. Nie zwierać zacisków. Regularnie sprawdzać, czy baterie</p>	<p>(CN) 只限使用规定的电池类型。非充电电池不能充电。充电电池只能在成年人监督下充电！充电电池在充电前应该从玩具中取出。不同类型的电池或新旧电池不能混用！电池应以正确的极性放入。用尽的电池应从玩具中取出。电源端子不得短路。用过的旧电池请勿随意丢弃在家庭垃圾中，而是放入回收站或者交给特殊处理处。（说明书上含有重要信息，请保留备用）</p>



71008



71010



71009



71012



71011



71294



71007



71293



71296



71295

