

# playmobil®



Official Licensed  
Product



71229



## **Motor • 4 Zylinder Boxermotor im Heck**

- Engine • Rear, 4-cylinder boxer engine
- Moteur • Moteur Boxer 4 cylindres à l'arrière
- Motor • Motor bóxer de 4 cilindros en la parte trasera

## **Antrieb • Hinterradantrieb**

- Drive • Rear-wheel drive
- Traction • Traction arrière
- Tracción • Tracción trasera

## **Leistung • 34 PS**

- Power • 34 HP
- Puissance • 34 CV
- Potencia • 34 CV



Der kultige Volkswagen T1 Camping Bus in einer neuen Farbvariante exklusiv für Edeka in limitierter Auflage! Mit voll ausgestattetem Innenraum und viel Platz zum Verstauen der getätigten Einkäufe.

The iconic Volkswagen T1 Camping Bus now in a new limited edition colour variant, exclusively for Edeka! With fully equipped interior and plenty of space to store the purchases made.

L'icónique Volkswagen Combi T1 est maintenant disponible dans une nouvelle variante de couleur, en édition limitée pour Edeka. Avec un intérieur entièrement équipé et de nombreux rangements pour y stocker les courses et achats.

¡El icónico Volkswagen T1 Camping Bus en un nuevo color exclusivo para Edeka en edición limitada! Con un interior totalmente equipado y mucho espacio para guardar.

1950 –

1967

Bauzeit  
Years in Production  
Années de fabrication  
Fecha de fabricación

1962

Modelljahr (PLAYMOBIL-Modell)  
Model Year (PLAYMOBIL model)  
Année du modèle (modèle PLAYMOBIL)  
Año del modelo (Modelo PLAYMOBIL)

95 km/h

Höchstgeschwindigkeit  
Maximum Speed  
Vitesse maximale  
Velocidad máxima





● 70177



Official Licensed Product



● 70176



70764



70765



70923

PORSCHE



70921



MINI trademarks used are licensed by BMW AG.



● 70922

# BACK TO THE FUTURE



● 70317



© Universal City Studios LLC and Amblin Entertainment, Inc. All Rights Reserved



● 70924

# KNIGHT RIDER



© Universal City Studios LLC .  
All Rights Reserved



● 70750

THE  
A-TEAM

The A-Team TM &  
© 20th Century Studios



● 70578



007™



ASTON MARTIN

007™ and related James Bond Trademarks, TM Danjaq.  
"Aston Martin" and the Aston Martin "wings" logo are trade marks of Aston Martin Lagonda Limited.

**NEU new**  
Nouveau  
nuevo



**Aufbauen leicht gemacht mit nummerierten Tüten.  
Viel Spaß mit deinem neuen PLAYMOBIL-Spielzeug!**

**Set-up made easy with numbered bags.  
Have fun with your new PLAYMOBIL toy!**

**Simplicité de montage avec les sachets numérotés.  
Amuse-toi avec tes nouveaux PLAYMOBIL!**

**El montaje es más fácil con  
las bolsas numeradas.  
¡Diviértete con tu nuevo  
juguete de PLAYMOBIL!**





# WARNING: CHOKING HAZARD

Contains a small ball and small parts.  
Not for children under 3 years.

“Ne concerne que les USA”

Wichtige Unterlagen, bitte sorgfältig aufbewahren!  
Important: Please keep these instructions for future reference!  
Documents importants, à conserver soigneusement!  
¡Por favor, guarde estas instrucciones para el futuro!  
Belangrijke documenten, bewaar deze zorgvuldig!

Abbildungen können vom Original abweichen.  
Product may differ from image shown.  
Les illustrations peuvent différer de l'original.  
Las ilustraciones pueden diferir del original.  
Afbeeldingen kunnen verschillen van het werkelijke artikel.

Serviceadressen finden Sie in allen  
PLAYMOBIL-Prospekten

Addresses of Customer Service Departments are shown in all PLAYMOBIL catalogues

L'adresse du service consommateurs est indiquée dans tous les catalogues PLAYMOBIL

Troverete gli indirizzi dei centri di assistenza in tutti i cataloghi PLAYMOBIL

**UK-Importer:**  
**Playmobil UK Ltd.**  
**Regency House**  
**1 Miles Gray Road**  
**Basildon**  
**Essex**  
**SS14 3RW**  
**UK**

**UK  
CA**

In alle PLAYMOBIL catalogi vindt u het adres van onze klantendienst.

Las Direcciones de los Departamentos de Servicio al Consumidor se encuentran en todos los catálogos PLAYMOBIL

Η διεύθυνση του Γραφείου Εξυπηρέτησης Καταναλωτών PLAYMOBIL βρίσκεται σε όλους τους καταλόγους PLAYMOBIL.

pronounced: plāy-mō-bēel

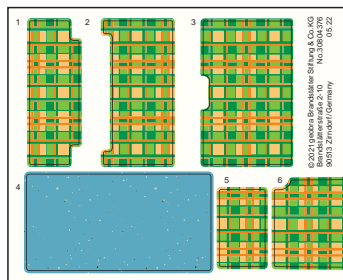

30 80 4376

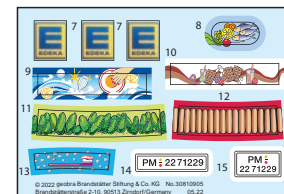

30 81 0905



30 80 4316





+

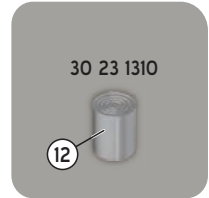
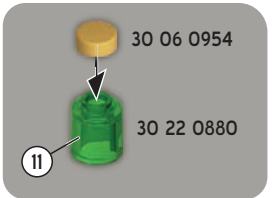
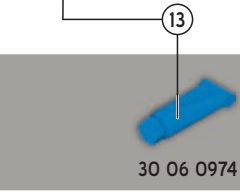
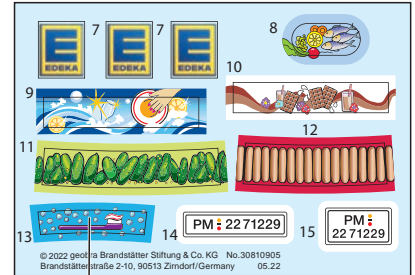
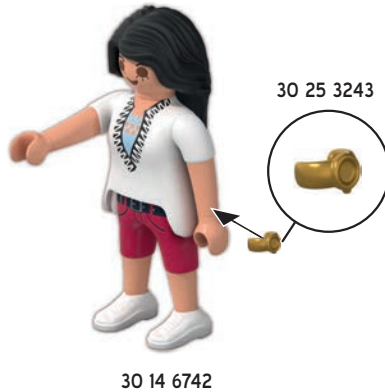
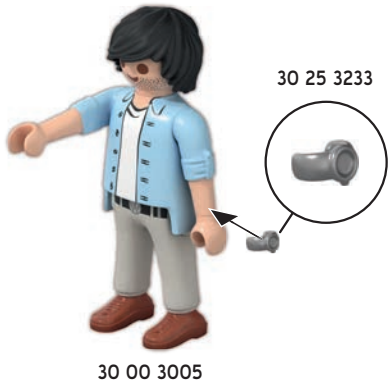

30 08 8973



30 08 9112

8



30 23 1290

3x

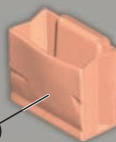

30 21 8593

30 06 0944



30 02 5034



30 62 4558



30 06 0984

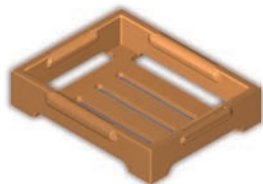

2x 30 07 3360



30 09 6780



30 09 6830



30 06 0934



30 22 3822



2x 30 06 3203



30 80 1335



30 06 0924



2x 30 06 0964



30 62 4558



30 62 6345



30 62 1875



30 62 1865



+



+



1

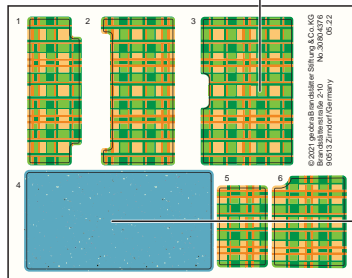
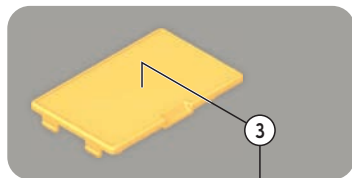

© 2021 GreenBilderwerke Stiftung & Co. KG  
Bismarckstraße 210  
50769 Köln, Germany  
0421

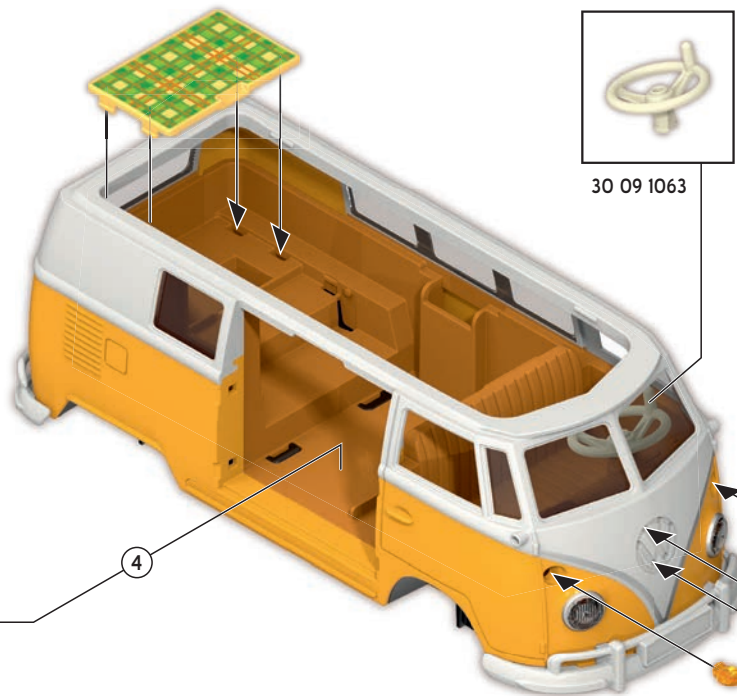

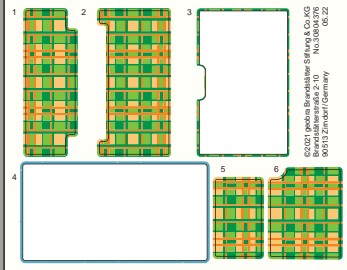

© 2022 gnomi Brandartikelherstellung & Co. KG  
 Brandartikelstraße 2-10 · No. 30819205  
 95113 Zimmertori/Germany 05.22

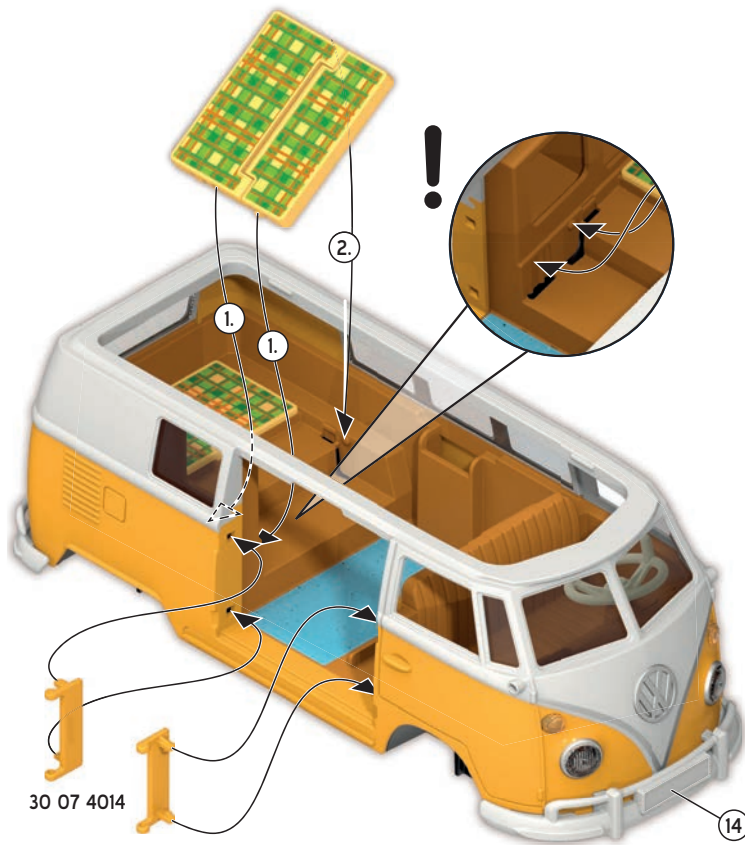
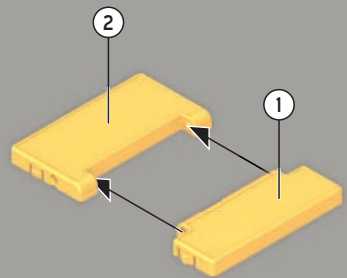

30 07 4014



CLICK

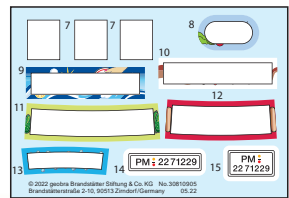

© 2022 gnomi Brandartikelherstellung & Co. KG · No. 30819205  
 Brandartikelstraße 2-10, 95113 Zimmertori/Germany 05.22

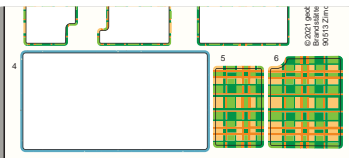

© 2022 gornix  
Brandenburgische Spielzeug & Co. KG  
Brandenburgische Spielzeug & Co. KG  
10013 Berlin

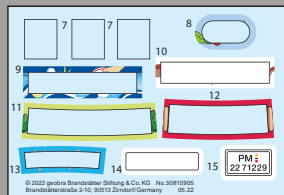
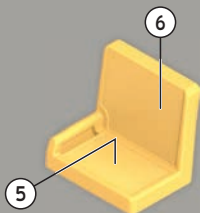

© 2022 gornix Brandenburgische Spielzeug & Co. KG No. 30810105  
Brandenburgische Spielzeug & Co. KG 10013 Berlin/Germany 05-22

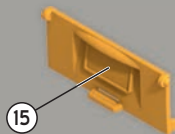

30 07 4024



30 09 1083

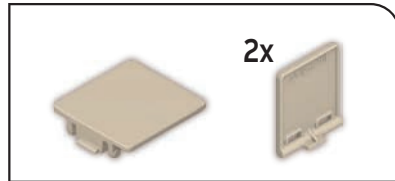

30 51 4253

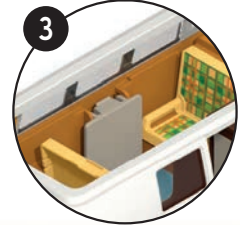
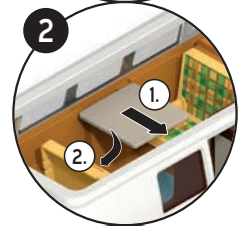
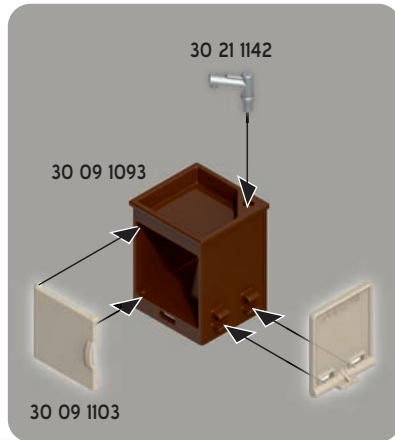

1

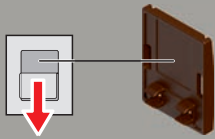

2

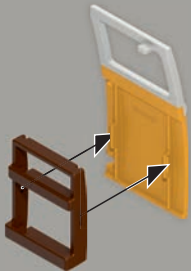
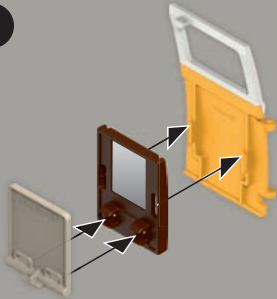

30 51 4263



30 51 4273



4x

1



2



