

playmobil®

CITY
ACTION



70779



WARNING: CHOKING HAZARD

Small parts. Not for children under 3 years.

"Ne concerne que les USA"

Wichtige Unterlagen, bitte sorgfältig aufbewahren!
Important: Please keep these instructions for future reference!
Documents importants, à conserver soigneusement!
¡Por favor, guarde estas instrucciones para el futuro!
Belangrijke documenten, bewaar deze zorgvuldig!

Abbildungen können vom Original abweichen.
Product may differ from image shown.
Les illustrations peuvent différer de l'original.
Las ilustraciones pueden diferir del original.
Afbeeldingen kunnen verschillen van het werkelijke artikel.

Serviceadressen finden Sie in allen
PLAYMOBIL-Prospekten

Addresses of Customer Service Depart-
ments are shown in all PLAYMOBIL
catalogues

L'adresse du service consommateurs
est indiquée dans tous les catalogues
PLAYMOBIL

Troverete gli indirizzi dei centri di
assistenza in tutti i cataloghi PLAYMOBIL

UK-Importer:
Playmobil UK Ltd.
Regency House
1 Miles Gray Road
Basildon
Essex
SS14 3RW
UK

**UK
CA**

In alle PLAYMOBIL catalogi vindt u
het adres van onze klantendienst.

Las Direcciones de los Departamentos
de Servicio al Consumidor se encuentran
en todos los catálogos PLAYMOBIL

Η διεύθυνση του Γραφείου Εξυπηρέτησης
Καταναλωτών PLAYMOBIL βρίσκεται σε
όλους τους καταλόγους PLAYMOBIL.

pronounced: plāy-mō-bēel

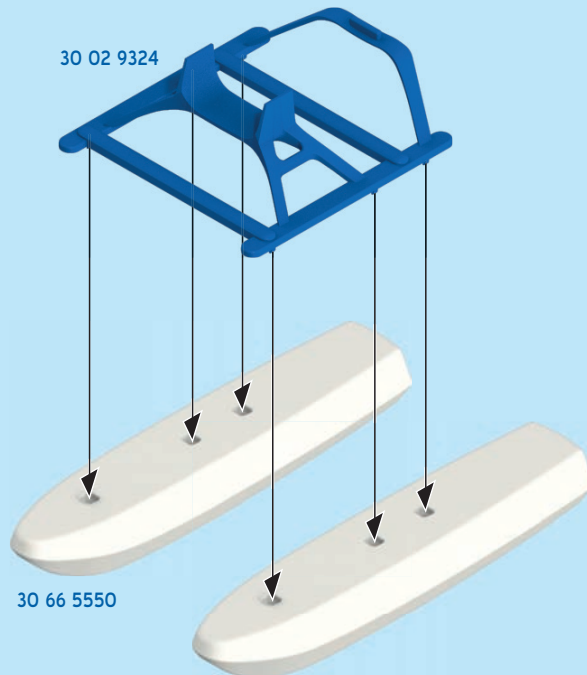

30 02 9324

30 66 5550

2

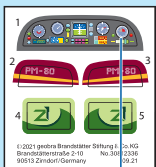

30 81 2336

1

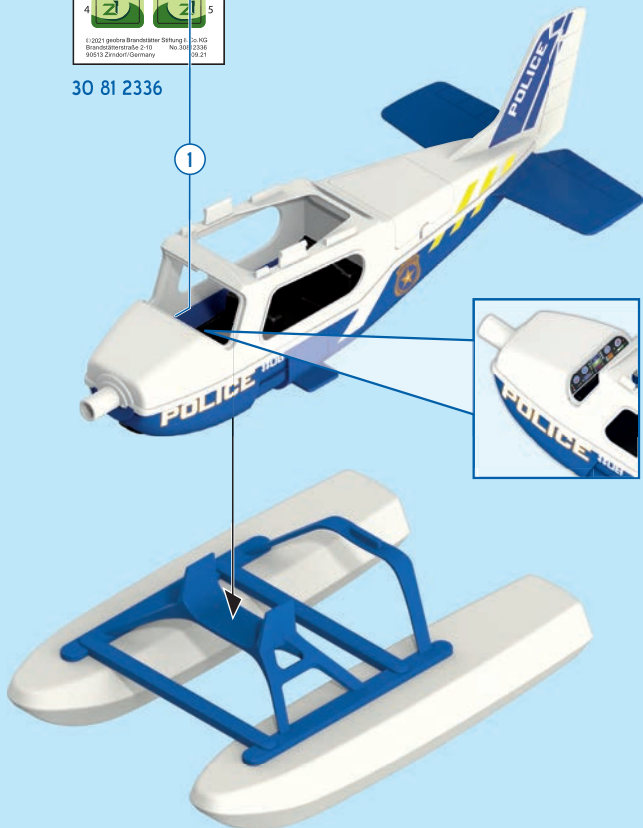

3

30 04 6000

30 02 9654





(DE) (AT) (CH) (LU) (BE) ACHTUNG!

- Nur im flachen Wasser unter Aufsicht von Erwachsenen verwenden. Nach dem Spielen austrocknen lassen.

(US) (GB) (CA) (MT) (IE) WARNING!

- Only to be used in water in which the child is within its depth and under adult supervision. Dry thoroughly after play.

(FR) (CA) (BE) (LU) (CH) ATTENTION!

- À n'utiliser qu'en eau où l'enfant a pied et sous la surveillance d'un adulte. Faire sécher après chaque utilisation.

(ES) (MX) ¡ADVERTENCIA!

- Utilizar sólo en agua donde el niño pueda permanecer de pie y bajo vigilancia de un adulto. Dejar secar antes de guardar.

(NL) (BE) WAARSCHUWING!

- Gebruiken in water waar kinderen kunnen staan en onder toezicht van volwassenen. Na het spelen laten drogen.

(IT) (CH) AVVERTENZA!

- Da utilizzare unicamente in acqua dove il bambino tocca il fondo con i piedi e sotto la sorveglianza di un adulto. Asciugare bene dopo ogni uso.

(PT) ATENÇÃO!

- Só utilizar em água onde a criança tenha pé e sob vigilância de adultos. Deixar secar antes de guardar.

(DK) ADVARSEL!

- Må kun anvendes under opsyn af en voksen og på vanddybder, hvor barnet kan bunde. Lad det tørre ud når du er færdig med at lege.

(NO) ADVARSEL!

- Skal kun brukes i vann som ikke er for dypt for barnet, og der barnet er under tilsyn. Tørk opp etter at leken er ferdig.

(SE) (FI) VARNING!

- Får endast användas i vatten där barnet bottnar och under tillsyn av en vuxen. Låt torka efter användandet.

(FI) VAROITUS!

- Lelua saa käyttää vain aikuisen valvonnassa vedessä, jossa lapsi ylettyy pohjaan. Anna kuivua leikin jälkeen.

(HU) FIGYELMEZTETÉS.

- Csak a gyermek magasságához képest biztonságos sekély vízben és felnőtt felügyelete mellett szabad használni! Játék után ajánlott a termék kiszáritása!

(CZ) UPOZORNĚNÍ!

- Používat pouze ve vodě takové hloubky, kde dítě stačí, a pouze pod dohledem dospělé osoby. Po hraní nechat vyschnout.

(EE) HOIATUS!

- Kasutada ainult täiskasvanu järelevalve all vees, kus laps ulatub jalgadega põhja. Mängimise järel kuivatada!

(LV) BRĪDINĀJUMS!

- Lietot tikai seklā ūdenī un pieaugušo uzraudzībā. Pēc spēlēšanas ļaut nožūt.

(LT) ĮSPĖJIMAS!

- Naudoti tik vaikui tinkamame gylyje ir prižiūrint suaugusie siems. Pažaidus, išdžiovinkite.

(SI) OPOZORILO!

- Uporabljajte samo v vodi, primerno plitvi za otroka in pod nadzorom odrasle osebe. Po igri naj se igrača posuši.

(SK) UPOZORNENIE!

- Používať len vo vode, v ktorej dieťa dočiahne na dno, a pod dohľadom dospeljej osoby. Po hre nechať vyschnúť.

(PL) OSTRZEŻENIE!

- Do używania jedynie w wodzie na głębokości, na której dziecko wyczuwa dno pod nogami oraz pod nadzorem osoby dorosłej. Po zabawie pozostaw do wyschnięcia.

(TR) (CY) ΔΙΚΚΑΤ!

- Sadece denetim altında ve sadece alçak sularda kullanın. Oyundan sonra kurumaya bırakın.

(GR) (CY) Προειδοποίηση!

- Να χρησιμοποιείται μόνο σε νερά όπου πατώνει το παιδί και υπό την επίβλεψη ενηλίκου. Μόλις τελειώσετε, αφήστε το παιχνίδι να στεγνώσει εντελώς.

(RO) AVERTISMENT!

- A se utiliza numai acolo unde copilul poate sta în picioare în apă și este sub supraveghere. După joacă se lasă să se usuce.

(BG) Внимание!

- Да се използва само във вода, която е дълбока до нормалния ръст на детето, и под надзора на възрастен. След игра оставете да изсъхне.

(HR) UPOZORENJE!

- Koristiti samo u plitkoj vodi pod nadzorom odraslih. Postije igranja pustiti da se osuši.

(RU) Внимание!

- Использовать только на мелководье под наблюдением взрослых. Дайте высохнуть после игры.

(CN) 警告!

仅供儿童在成人监护下在浅水中使用。玩具玩后请拭干。

1

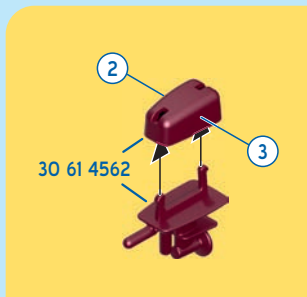
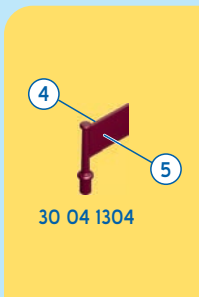
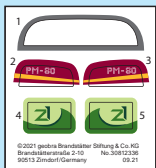

2



30 88 7940

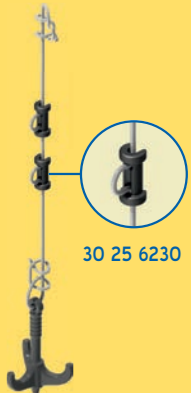

30 25 6230

30 09 9580

30 62 3557



30 21 0832



30 14 5532

30 63 4387



30 08 0360



30 25 0502



30 00 0145



30 23 6832



30 02 9634



30 62 0560



30 20 5830



70781



70779



70780



70782



©2021 geobra Brandstätter Stiftung & Co. KG
Brandstätterstr. 2-10
90513 Zirndorf, Germany
No. 30 81 4316 09.21

