

playmobil®

70748

NOVELMORE





VIOLET VALE

... ist die beschauliche und mystische Heimat von Zauberern und Zauberinnen wie Timithor, dem Zauberer der Zeit, sowie dem offiziellen Sitz des Hohen Rates der Zauberer.

Während die Bewohner Violet Vales ihre Traditionen und Weisheit bewahren und ihr magisches Spezialwissen zusammen mit anderen Zauberern anwenden, um das Gleichgewicht in der Welt von Novelmooe aufrechtzuerhalten, nehmen anderswo Spannungen zu und diverse Konflikte drohen auf Violet Vale überzugreifen. Eine Entwicklung, die einige zum Anlass nehmen zu diskutieren, ob es sich lohnt an den Traditionen festzuhalten oder Regeln zu brechen um drastischere Maßnahmen, nämlich Dunkle Magie, einzusetzen. Alles zur Verteidigung gegen die drohende Gefahr - oder...?

Welcome to Violet Vale, a peaceful and mystical home of wizards and sorceresses like Timithor, Wizard of Time, and the official seat of the Wizards' High Council.

While the people of Violet Vale cherish wisdom and traditions, as well as practicing their special magic in order to preserve the balance within the world of Novelmore, tensions are rising and conflicts threaten to spill over to Violet Vale. A development that makes some question whether or not to hold on to their traditions or break the rules and use more drastic magical measures, mainly Dark Magic, as a defense against any imminent threat. Or is it?

Bienvenue à Violet Vale, lieu paisible et mystique où vivent des sorciers et des sorcières comme Timithor, le magicien du temps, et où se trouve le siège officiel du Haut Conseil des sorciers.

Les habitants de Violet Vale sont les gardiens des traditions et de la sagesse. Ils pratiquent la magie ensemble, pour préserver l'équilibre dans le royaume de Novelmore. Mais des tensions naissent et les conflits menacent de s'étendre jusqu'à Violet Vale.

Ces événements fragilisent la tranquillité de Violet Vale : certains remettent en cause les traditions, et veulent enfreindre les règles en utilisant la Magie Noire pour se défendre. Que va-t-il arriver ?

Bienvenidos a Violet Vale, pacífico y místico hogar de magos y magas como Timithor, Mago del Tiempo, y sede oficial del Alto Consejo de Magos.

Mientras los habitantes de Violet Vale aprecian la sabiduría y las tradiciones, además de practicar su especialidad mágica de forma colaborativa para preservar el equilibrio dentro del mundo de Novelmore, las tensiones aumentan en el mundo y los conflictos amenazan con extenderse a Violet Vale. Un acontecimiento que algunos toman como motivo para discutir si se aferran o no a esa tradición o rompen una regla para utilizar medidas mágicas más drásticas, principalmente la Magia Oscura - una defensa ante cualquier amenaza inminente. ¿O es realmente así?

TIMITHOR

Zauberer der Zeit, Hüter der Invincibus, etwas exzentrisch, aber kommt gut mit unseren Novelmore-Helden aus

Wizard of Time, keeper of the Invincibus, a little eccentric but on good terms with our Novelmore heroes

Magicien du temps, gardien de l'Invincibus, un peu excentrique mais en bons termes avec nos héros de Novelmore

Mago del Tiempo, guardián de la Invincibus, un poco excéntrico pero en buenos términos con nuestros héroes de Novelmore

UMBRATHOR

Twilight-Zauberer, Verfechter von Dunkler Magie, beschwört Dämonen welche seine Arbeit für ihn erledigen sollen

Twilight Wizard, advocate of Dark Magic, likes to summon demons to do his work

Twilight Wizard, défenseur de la magie noire, aime invoquer des démons pour faire son travail

Mago del Crepúsculo, defensor de la Magia Oscura, le gusta invocar demonios para hacer su trabajo





ANDOWAN

Lehrling, sehr interessiert an Magie, will Gutes tun



Apprentice, very interested in magic, wants to do good



Apprenti, très intéressé par la magie, veut faire le bien



Aprendiz, muy interesado en la magia, quiere hacer el bien

OMAGUS

Lehrling, mag keine Regeln, arbeitet gern allein



Apprentice, doesn't like rules, likes to work alone



Apprenti, n'aime pas les règles, aime travailler seul



Aprendiz, no le gustan las reglas, le gusta trabajar solo

The image shows three LEGO minifigures in a fantasy setting. On the left is Gwynn, a female knight in a blue hooded cloak and armor, holding a sword. In the center is Arwynn, a prince with blonde hair in silver armor, holding a sword. On the right is Dario, an inventor with a red hat and goggles, holding a sword and a map. In the background, there is a stone castle on a cliff under a bright sun with a small flying object in the sky.

GWYNN

ARWYNN

DARIO

Erste Ritterin und Co-General der Armee, mutig, gewitzt

First female knight and co-general of the army. Brave and witty.

Première femme chevalier et co-générale de l'armée, courageuse, vive

Primera mujer caballero y co-general del ejército, valiente, ingeniosa

Prinz von Novelmore, abenteuerlustig, kämpft für das Gute

Prinze of Novelmore, adventurous soul, fights for his cause

Le prince de Novelmore, âme aventureuse, se bat pour la bonne cause

Príncipe de Novelmore, alma aventurera, lucha por la buena causa

Genialer Erfinder, etwas schüchtern aber setzt alles für Novelmore und seine Freunde in Bewegung

Brilliant inventor, a little shy but goes out of his way for Novelmore and his friends

Inventeur brillant, un peu timide mais qui se donne du mal pour Novelmore et ses amis

Brillante inventor, un poco tímido pero se desvive por Novelmore y sus amigos



WARNING: CHOKING HAZARD

Contains a small ball and small parts.
Not for children under 3 years.

Ne concerne que les USA

Wichtige Unterlagen, bitte sorgfältig aufbewahren!
Important: Please keep these instructions for future reference!
Documents importants, à conserver soigneusement!
¡Por favor, guarde estas instrucciones para el futuro!
Belangrijke documenten, bewaar deze zorgvuldig!

Abbildungen können vom Original abweichen.
Product may differ from image shown.
Les illustrations peuvent différer de l'original.
Las ilustraciones pueden diferir del original.
Afbeeldingen kunnen verschillen van het werkelijke artikel.

Serviceadressen finden Sie in allen
PLAYMOBIL-Prospekten

Addresses of Customer Service Departments
are shown in all PLAYMOBIL
catalogues

L'adresse du service consommateurs
est indiquée dans tous les catalogues
PLAYMOBIL

Troverete gli indirizzi dei centri di
assistenza in tutti i cataloghi PLAYMOBIL

In alle PLAYMOBIL catalogi vindt u
het adres van onze klantendienst.

Las Direcciones de los Departamentos
de Servicio al Consumidor se encuentran
en todos los catálogos PLAYMOBIL

Η διεύθυνση του Γραφείου Εξυπηρέτησης
Καταναλωτών PLAYMOBIL βρίσκεται σε
όλους τους καταλόγους PLAYMOBIL.

pronounced: play-mo-beel



1



2

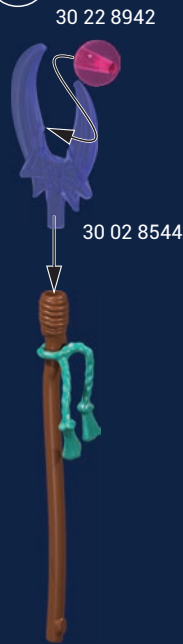

1

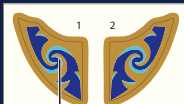

© 2020 gestora B. Produkt der Stiftung & Co. KG. Reg. No. 30809376
Brennstoffstraße 12-16, 10513, Berlin, Germany 03 21

30 80 8976

1

2



30 02 8644



30 02 8584

2

2x



30 63 3927 30 07 7310



30 02 8654

3

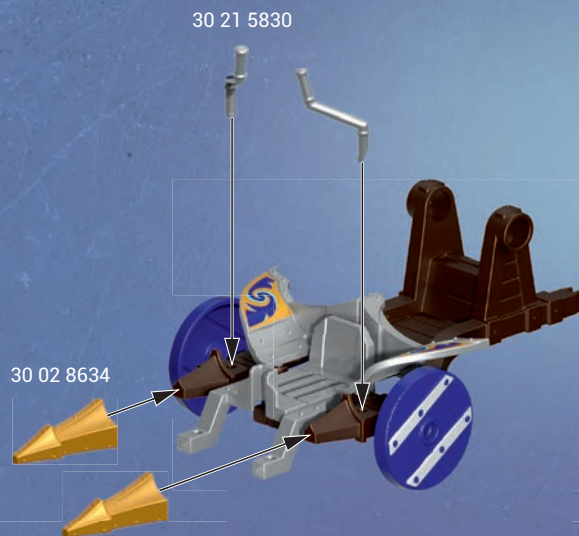

4



5



30 02 8674

30 02 8684



6

2x

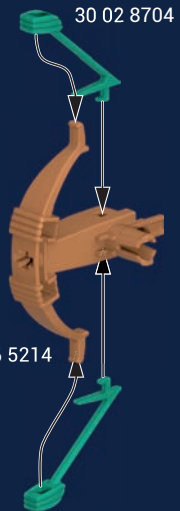

30 02 8704

30 66 5214

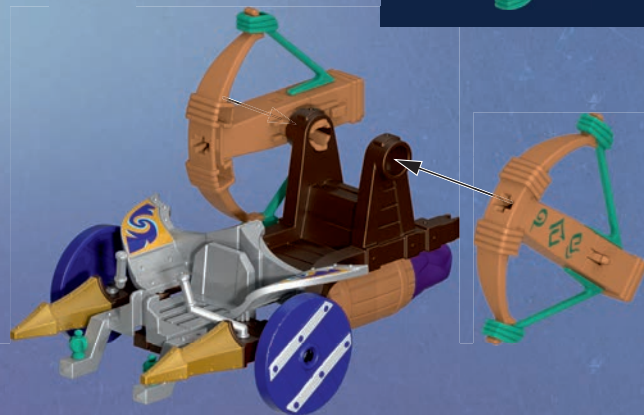

7

30 02 8084

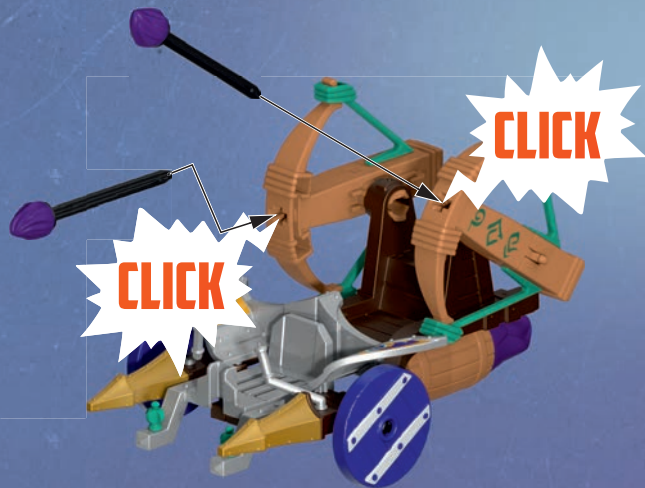

8



DE AT CH LU BE **ACHTUNG!** Nur mitgelieferte PLAYMOBIL Geschosse verwenden. Nicht auf Augen oder Gesicht zielen.

US GB CA MT IE **WARNING!** Only use the PLAYMOBIL projectiles supplied. Do not aim at eyes or face.

FR CA BE LU CH **ATTENTION!** Seulement utiliser les projectiles PLAYMOBIL fournis. Ne pas viser les yeux ou le visage

ES MX **¡ADVERTENCIA!** Utiliza únicamente los proyectiles PLAYMOBIL suministrados. No apuntar a los ojos ni a la cara.

NL BE **WAARSCHUWING!** Uitsluitend meegeleverde PLAYMOBIL delen gebruiken. Niet op ogen of gezicht richten.

IT CH **AVVERTENZA!** Usare soltanto i proiettili PLAYMOBIL in dotazione. Non mirare agli occhi o al viso.

PT **ATENÇÃO!** Usar apenas os projecteis PLAYMOBIL juntamente fornecidos. Não apontar para os olhos ou face.

DK **ADVARSEL!** Anvend kun de medfølgende PLAYMOBIL projektiler. Sigt ikke mod øjne eller ansigt.

NO **ADVARSEL!** Benytt kun PLAYMOBIL prosjektil som leveres med. Sikt ikke på ansikt eller øyne.

SE FI **VARNING!** Använd endast medlevererade PLAYMOBIL-skott. Ei saa kohdistaa suoraan silmiin tai kasvoihin.

FI **VAROITUS!** Käytä vain mukana toimitettuja PLAYMOBIL-ammuksia. Älä tähtää päin silmiä tai kasvoja.

HU **FIGYELMEZTETÉS.** Csak a csomagban található PLAYMOBIL lövedékeket szabad használni. Tilos szemre vagy arcra célozni.

CZ **UPOZORNĚNÍ!** Používejte pouze střely PLAYMOBIL, které jsou součástí dodávky. Nemiřte na oči nebo na obličej!

EE **HOIATUS!** Kasutage ainult kaasaantud PLAYMOBIL'i laskemoona. Ära sihi silmadesse ega näkku.

LV **BRĪDINĀJUMS!** Izmantot tikai PLAYMOBIL piegādes komplektā iekļautos šāviņus. Nevērst pret acīm vai seju.

LT **ĮSPĖJIMAS!** Naudokite tik pridedamus PLAYMOBIL šaudmenis. Netaikyti į akis arba veidą.

SI **OPOZORILO!** Uporabljajte le priložene PLAYMOBIL-ove krogle. Ne merite v oči ali obraz.

SK **UPOZORNENIE!** Používajte len náboje dodávané spolu so sadou PLAYMOBIL. Nemieriť do očí alebo do tváre.

PL **OSTRZEŻENIE!** Stosować tylko załączone PLAYMOBIL - kule / pociski. Nie celować w oczy i twarz.

TR **CY** **DIKKAT!** Sadece birlikte verilen PLAYMOBIL mermileri kullanınız. Göze veya yüze doğru tutmayınız.

GR **CY** **Προειδοποίηση!** Να χρησιμοποιούνται αποκλειστικά τα βλήματα της PLAYMOBIL που περιέχονται στη συσκευασία. Μη μην γίνεται στόχευση στα μάτια ή στο πρόσωπο.

RO **AVERTISMENT!** Se folosesc doar proiectilele incluse PLAYMOBIL. Nu se țintește în ochi sau în față.

BG **Внимание!** Използвайте само приложени PLAYMOBIL снаряди. Не насочвайте към очите и лицето.

HR **UPOZORENJE!** Upotrijebiti samo od strane PLAYMOBIL-a isporučene projekte. Ne ciljati u oči ili lice.

RU **Внимание!** Используйте только поставляемые в комплекте снаряды PLAYMOBIL. Не цельтесь в глаза или в лицо.

CN **警告!** 仅能用PLAYMOBIL 弹射物, 请勿瞄准眼睛或脸。

(说明书上含有重要信息, 请保留备用)





30 02 8574

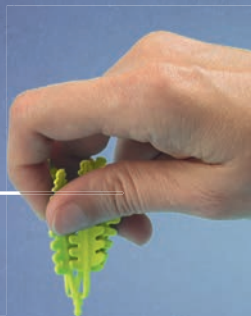

30 02 8564



30 63 3797



30 66 5204

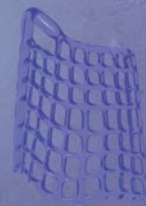

30 02 8554



30 02 8074

UK-Importer:
Playmobil UK Ltd.
Regency House
1 Miles Gray Road
Basildon
Essex
SS14 3RW
UK

UK
CA



70751



70746



70220



70221



70747



70749



70748



70745



playmobil®

Watch it on
YouTube and
YouTube Kids



Actiongeladene Novelmore-Abenteuer jetzt auch als Serie!
Folge uns auf unseren Social-Media-Kanälen.

Continue les aventures des Novelmore avec notre nouveau
dessin animé ! Disponible sur nos réseaux sociaux !

Action-packed Novelmore adventures, now a series!
Follow us on social media for exciting updates.

Aventuras de Novelmore llenas de acción ¡ahora también como
una serie! Síguenos en nuestros canales de redes sociales.

www.playmobil.com

©2021 geobra Brandstätter Stiftung & Co. KG
Brandstätterstr. 2-10 • 90513 Zirndorf, Germany
No. 30 81 2126 03.21

