

playmobil®

70412



WARNING:
CHOKING HAZARD

Small parts. Not for children under 3 years.

"Ne concerne que les USA"

Wichtige Unterlagen, bitte sorgfältig aufbewahren!
Important: Please keep these instructions for future reference!
Documents importants, à conserver soigneusement!
Belangrijke documenten, bewaar deze zorgvuldig!



© 2020 Janine Brandstätter Stiftung & Co. KG. No. 3022870
Brandstätterstraße 2-16, 90513 Zirndorf/Germany
10.19

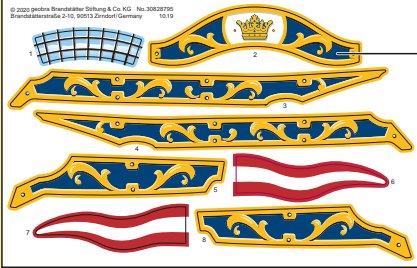

1

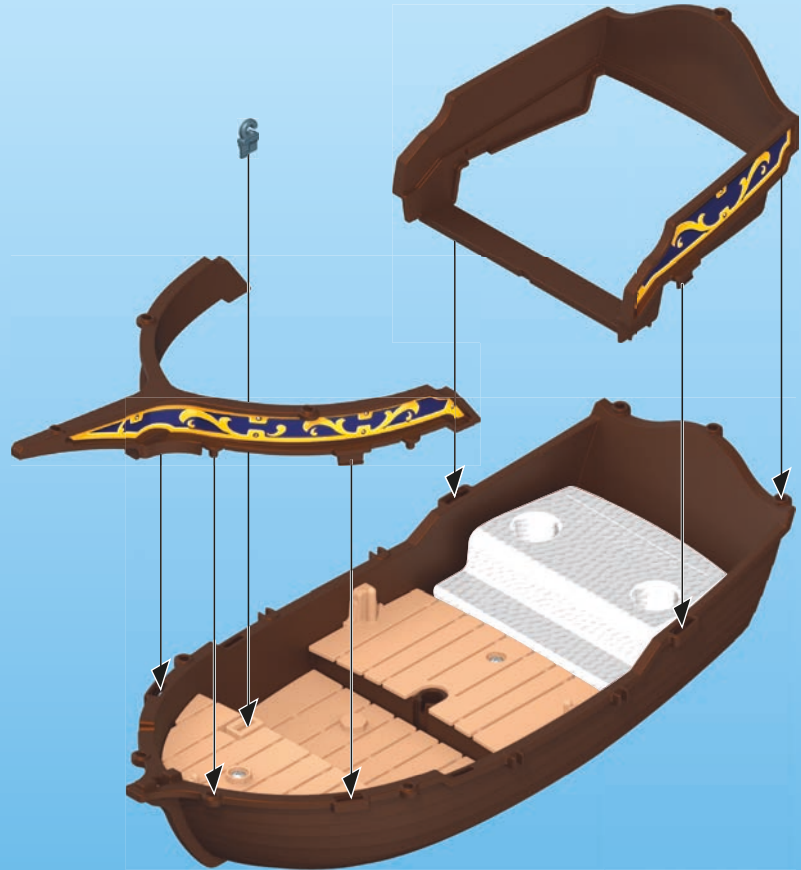
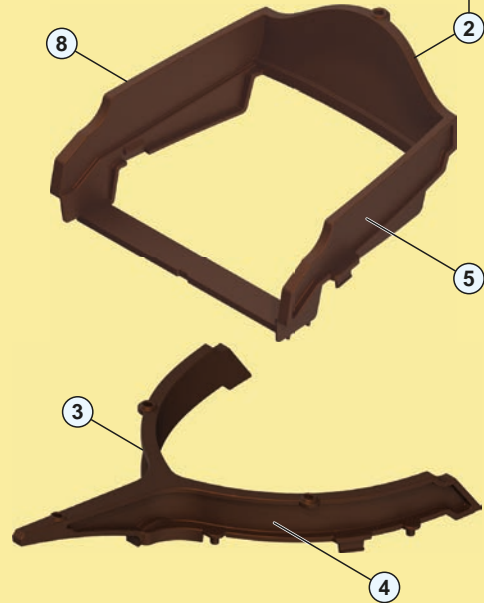

2

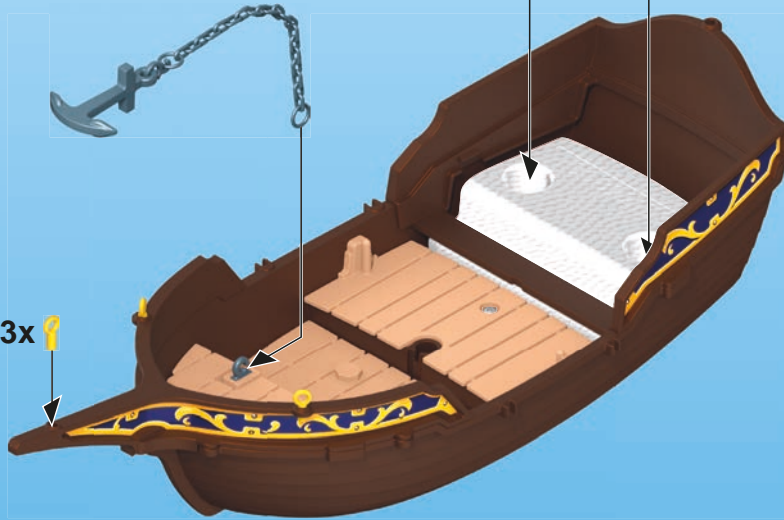
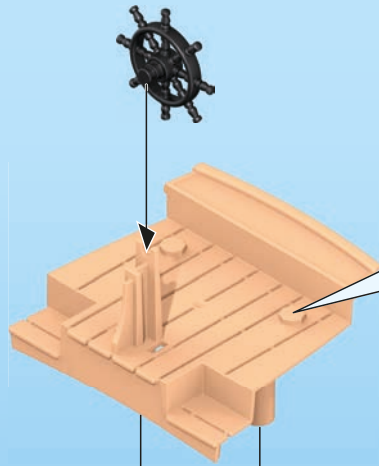
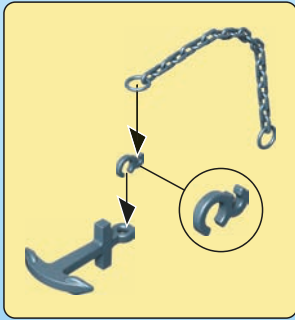

3

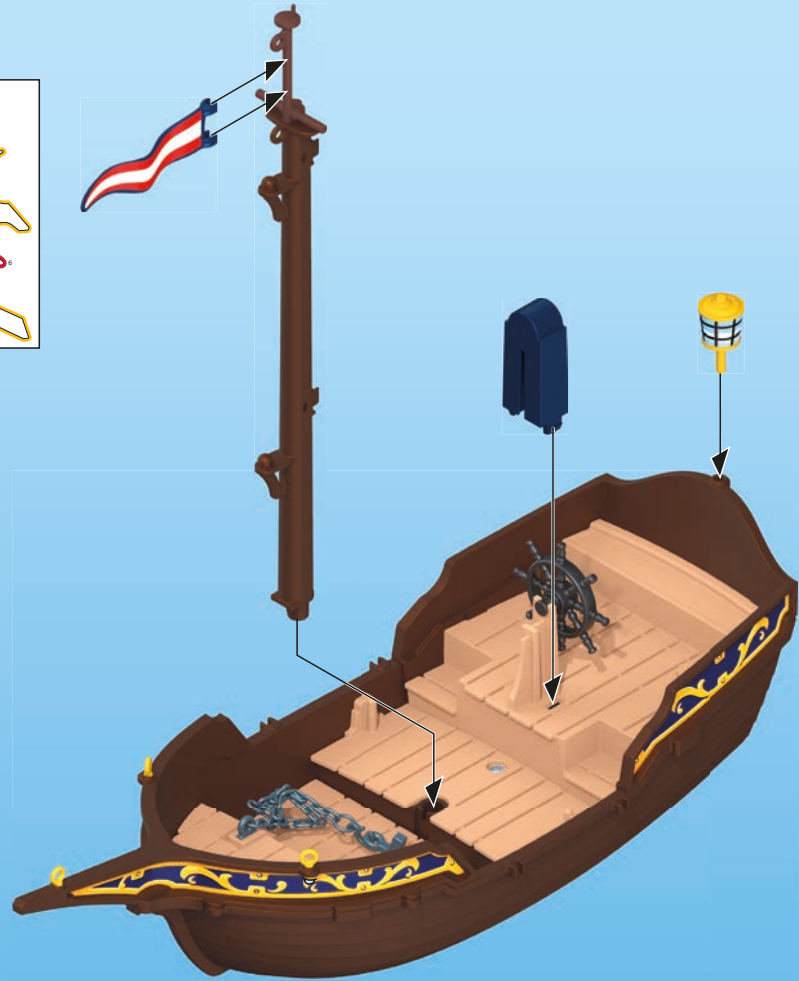
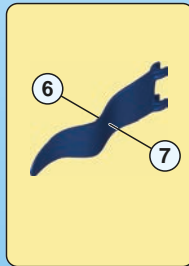
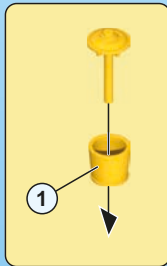
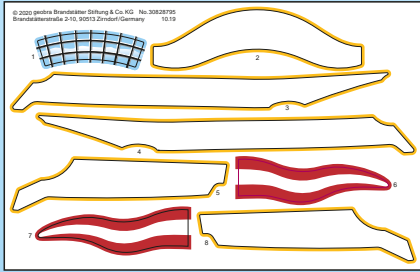
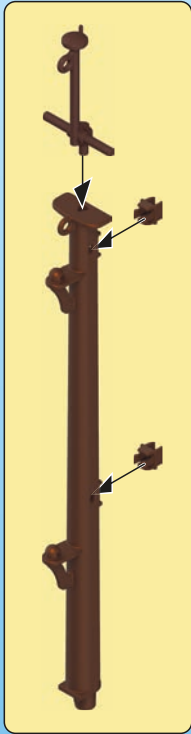

4

1

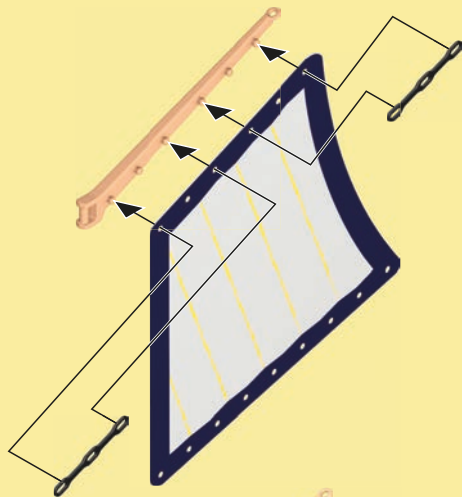

2

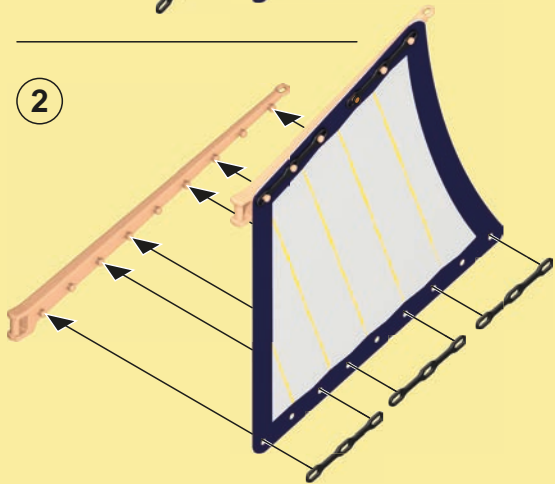

4

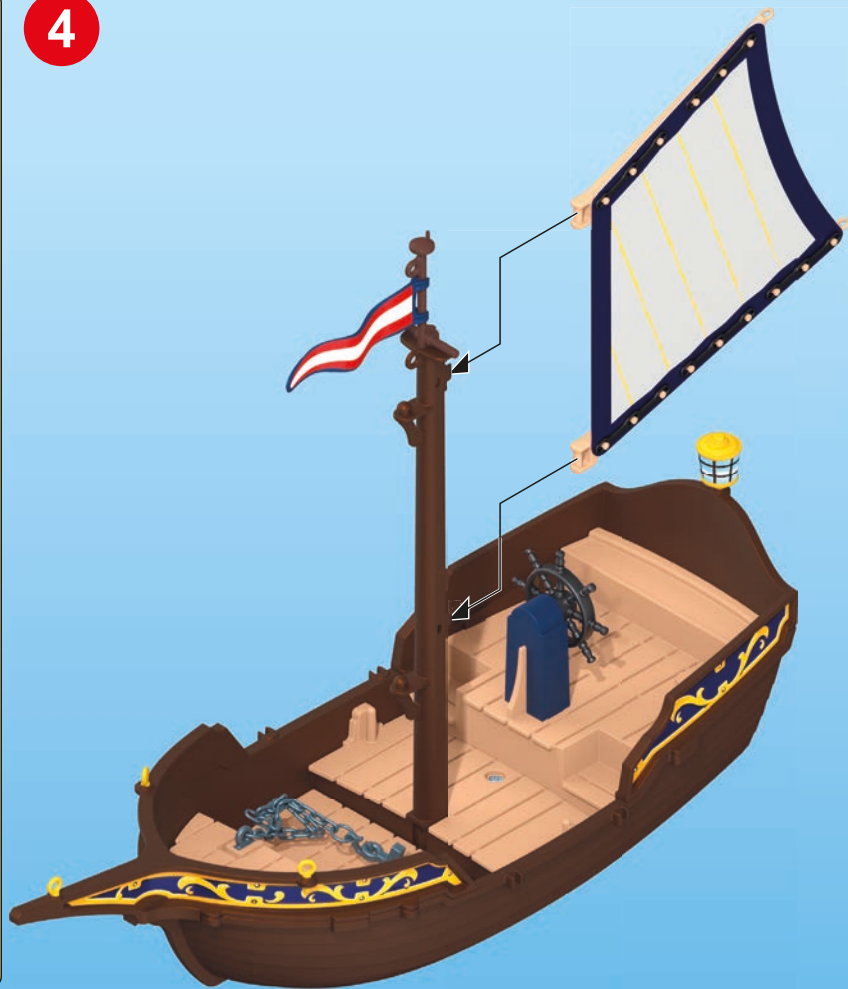

1

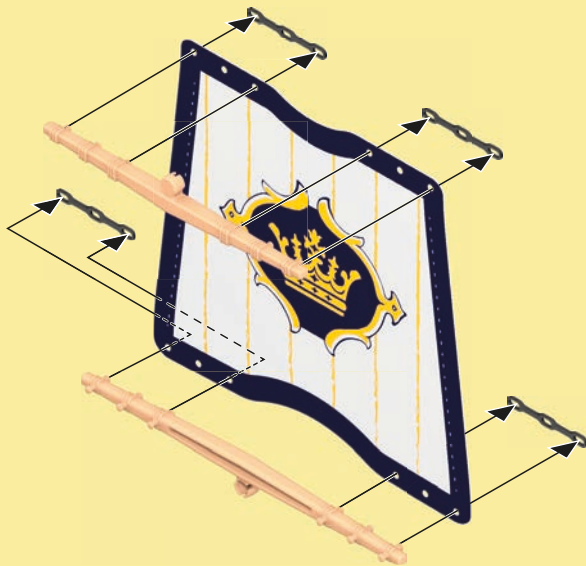

2

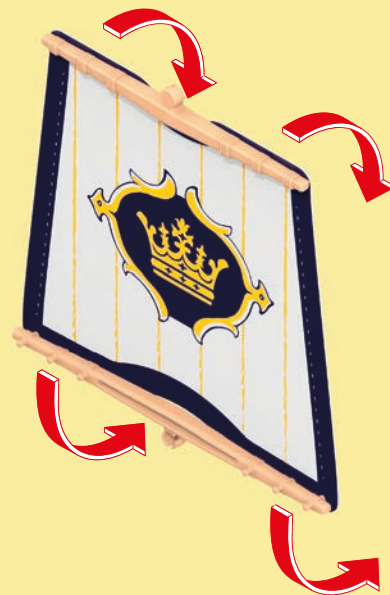

5

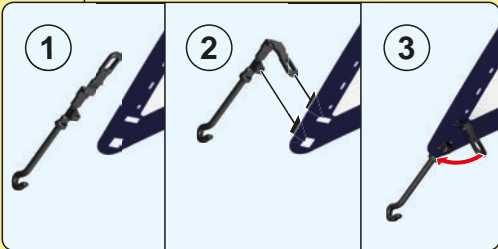



5159
7350



- Nachrüstbar mit Unterwassermotor
- Compatible with the underwater motor (sold separately)
- Monteur submersible, vendu séparément, s'adapte sur ce bateau

- DE AT CH LU BE** Anbaumöglichkeiten des RC-UW-Motors finden Sie unter: RC-Motor.playmobil.com
- US GB CA MT IE** For RC UW motor attachment possibilities, visit: RC-Motor.playmobil.com
- FR CA BE LU CH** Vous trouverez des informations complémentaires sur le site Internet: RC-Motor.playmobil.com
- ES MX** Las posibilidades de montaje del motor submarino RC se pueden consultar en: RC-Motor.playmobil.com
- NL BE** Aanbouwmogelijkheden van de RC-Onderwatermotor vindt u op: RC-Motor.playmobil.com
- IT CH** Le possibilità di montaggio del motore RC-UW sono descritte al sito: RC-Motor.playmobil.com
- PT** As possibilidades de montagem do motor RC subaquático pode ser consultadas em: RC-Motor.playmobil.com
- DK** Montagemuligheder for RC-UW-motoren finder du på: RC-Motor.playmobil.com
- NO** Monteringsmuligheter for RC-UW-motoren finner du under: RC-Motor.playmobil.com
- SE FI** RC-undervattensmotorns monteringsmöjligheter hittar du på: RC-Motor.playmobil.com
- FI** Vedenalaisen RC-moottorin asennusmahdollisuksia löytyy osoitteesta: RC-Motor.playmobil.com
- HU** Az RC-UW- Motor hozzáépítési lehetőségeiről az RC-Motor.playmobil.com alatt talál anyagot.
- CZ** Možnosti instalace lodního motoru s dálkovým ovládním najdete na internetové adrese RC-Motor.playmobil.com
- EE** RC-UW-Motor'i paigaldusjuhised leiate aadressil: RC-Motor.playmobil.com
- LV** Informāciju par RC-UVV motora montāžas iespējām skati vietnē: RC-Motor.playmobil.com
- LT** RC UW variklio pritvirtinimo galimybės pateikiamos tokiame internetiniame puslapyje: RC-Motor.playmobil.com
- SI** Možni načini namestitve daljinsko krmiljenega (RC) podvodnega (UW) motorja so na voljo na naslovu: RC-Motor.playmobil.com
- SK** Možnosti inštalácie lodného motora s diaľkovým ovládním nájdete na internetovej adrese RC-Motor.playmobil.com
- PL** Możliwości zastosowania podwodnego silnika RC znajdują się na stronie: RC-Motor.playmobil.com
- TR CY** Uzaktan kumandalı su altı motorunun montaj kılavuzu RC-Motor.playmobil.com sayfasında gösterilmiştir
- GR CY** Οδηγίες συναρμολόγησης του τηλεκατευθυνόμενου μοτέρ με υπέρυθρες ακτίνες θα βρείτε στην ηλεκτρονική διεύθυνση: RC-Motor.playmobil.com
- RO** Posibilități de montare a motorului submersibil cu telecomandă se găsesc pe site-ul: RC-Motor.playmobil.com
- BG** Възможности за допълнително оборудване на RC-електромотора за под вода можете да намерите на адрес: RC-Motor.playmobil.com
- HR** Mogućnosti dogradnje RC-UW-Motora ćete pronaći pod: RC-Motor.playmobil.com
- RU** Поиск вариантов монтажа двигателя RC-UW Ты под: RC-Motor.playmobil.com
- CN** 了解红外线水下电机的安装方法请访问以下网站: RC-Motor.playmobil.com

DE AT CH LU BE ACHTUNG!

- Nur im flachen Wasser unter Aufsicht von Erwachsenen verwenden. Nach dem Spielen austrocknen lassen.
- Nur mitgelieferte PLAYMOBIL Geschosse verwenden. Nicht auf Augen oder Gesicht zielen.

US GB CA MT IE WARNING!

- Only to be used in water in which the child is within its depth and under adult supervision. Dry thoroughly after play.
- Only use the PLAYMOBIL projectiles supplied. Do not aim at eyes or face.

FR CA BE LU CH ATTENTION!

- À n'utiliser qu'en eau où l'enfant a pied et sous la surveillance d'un adulte. Faire sécher après chaque utilisation.
- Seulement utiliser les projectiles PLAYMOBIL fournis. Ne pas viser les yeux ou le visage.

ES MX ¡ADVERTENCIA!

- Utilizar sólo en agua donde el niño pueda permanecer de pie y bajo vigilancia de un adulto. Dejar secar antes de guardar.
- Utiliza únicamente los proyectiles PLAYMOBIL suministrados. No apuntar a los ojos ni a la cara.

NL BE WAARSCHUWING!

- Gebruiken in water waar kinderen kunnen staan en onder toezicht van volwassenen. Na het spelen laten drogen.
- Uitsluitend meegeleverde PLAYMOBIL delen gebruiken. Niet op ogen of gezicht richten.

IT CH AVVERTENZA!

- Da utilizzzare unicamente in acqua dove il bambino tocca il fondo con i piedi e sotto la sorveglianza di un adulto. Asciugare bene dopo ogni uso.
- Usare soltanto i proiettili PLAYMOBIL in dotazione. Non mirare agli occhi o al viso.

PT ATENÇÃO!

- Só utilizar em água onde a criança tenha pé e sob vigilância de adultos. Deixar secar antes de guardar.
- Usar apenas os projecteis PLAYMOBIL juntamente fornecidos. Não apontar para os olhos ou face.

DK ADVARSEL!

- Må kun anvendes under opsyn af en voksen og på vanddybder, hvor barnet kan bunde. Lad det tørre ud når du er færdig med at lege.
- Anvend kun de medfølgende PLAYMOBIL projektiler. Sigst ikke mod øjne eller ansigt.

NO ADVARSEL!

- Skal kun brukes i vann som ikke er for dypt for barnet, og der barnet er under tilsyn. Tørk opp etter at leken er ferdig.
- Benytt kun PLAYMOBIL prosjektil som leveres med. Sikt ikke på ansikt eller øyne.

SE FI VARNING!

- Får endast användas i vatten där barnet bottnar och under tillsyn av en vuxen. Låt torka efter användandet.
- Använd endast medlevererade PLAYMOBIL-skott. Sikta inte mot ögon eller ansikte.

FI VAROITUS!

- Lelua saa käyttää vain aikuisen valvonnassa vedessä, jossa lapsi ylletty pohjaan. Anna kuivua leikin jälkeen.
- Käytä vain mukana toimitettuja PLAYMOBIL-ammuksia. Ei saa kohdistaa suoraan silmiin tai kasvoihin.

HU FIGYELMEZTETÉS.

- Csak a gyermek magasságához képest biztonságos sekély vízben és felnyit felügyelete mellett szabad használni!
- Játék után ajánlott a termék kiszáradtatása!
- Csak a csomagban található PLAYMOBIL lövedékeket szabad használni. Tilos szemre vagy arcra célozni.

CZ UPOZORNĚNÍ!

- Používat pouze ve vodě takové hloubky, kde dítě stačí, a pouze pod dohledem dospělé osoby. Po hraní nechat vyschnout.
- Používejte pouze střely PLAYMOBIL, které jsou součástí dodávky. Nemířte na oči nebo na obličej!

EE HOIATUS!

- Kasutada ainult täiskasvanu järelevalve all vees, kus laps ulatub jalgadega põhja. Mängimise järel kuivatada!
- Kasutage ainult kaasaantud PLAYMOBIL'i laskemoona.
- Ära sihi silmadesse ega näkku.

LV BRĪDINĀJUMS!

- Lietot tikai sekļā ūdenī ar pieaugušo uzraudzībā. Pēc spēlēšanas ļaut nožūt.
- Izmantot tikai PLAYMOBIL piegādes komplektā iekļautos šāvinus. Nevērst pret acīm vai seju.

LT ĮSPĖJIMAS!

- Naudoti tik vaikai tinkamame gylyje ir prižiūrint suaugusiųsiesiems. Pažaidus, išdžiovinkite.
- Naudokite tik pridedamus PLAYMOBIL šaudmenis.
- Netaikyti į akis arba veidą.

SI OPOZORILO!

- Uporabljajte samo v vodi, primerno plitvi za otroka in pod nadzorom odrasle osebe. Po igri naj se igrača posušiti.
- Uporabljajte le priložene PLAYMOBIL-ove kroglice. Ne merite v oči ali obraz.

SK UPOZORNENIE!

- Používať len vo vode, v ktorej dieťa dočiahne na dno, a pod dohľadom dospelého osoby. Po hre nechať vyschnúť.
- Používajte len náboje dodávané spolu so sadou PLAYMOBIL. Nemierť do očí alebo do tváre.

PL OSTRZEŻENIE!

- Do używania jedynie w wodzie na głębokości, na której dziecko wyczuwa dno pod nogami oraz pod nadzorem osoby dorosłej. Po zabawie pozostaw do wyschnięcia.
- Stosować tylko załączone PLAYMOBIL - kule / pociski. Nie celować w oczy i twarz.

TR CY DİKKAT!

- Sadece denetim altında ve sadece alçak sularla kullanın. Oyundan sonra kurumaya bırakın.
- Sadece birlikte verilen PLAYMOBIL mermileri kullanınız. Göze veya yüze doğru tutmayın.

GR CY Προειδοποίηση!

- Να χρησιμοποιείται μόνο σε νερά όπου πατώνει το παιδί και υπό την επίβλεψη ενήλικα. Μόλις τελειώσετε, αφήστε το παιχνίδι να στεγνώσει εντελώς.
- Να χρησιμοποιούνται αποκλειστικά τα βλήματα της PLAYMOBIL που περιέχονται στη συσκευασία. Μη μην γίνεται στόχευση στα μάτια ή στο πρόσωπο.

RO AVERTISMENT!

- A se utiliza numai acolo unde copilul poate sta în picioare în apă și este sub supraveghere. După joacă se lasă să se usuce.
- Se folosesc doar proiectilele incluse PLAYMOBIL. Nu se țintește în ochi sau în față.

BG Внимание!

- Да се използва само във вода, която е дълбока до нормалния ръст на детето, и под надзора на възрастен. След игра оставете да изсъхне.
- Използвайте само приложени PLAYMOBIL снаряди. Не насочвайте към очите и лицето.

HR UPOZORNENJE!

- Koristiti samo u plitkoj vodi pod nadzorom odraslih. Poslije igranja pustiti da se osuši.
- Upotrijebiti samo od strane PLAYMOBIL-a isporučene projektile. Ne ciljati u oči ili lice.

RU Внимание!

- Использовать только на мелководье под наблюдением взрослых. Дайте высохнуть после игры.
- Используйте только поставляемые в комплекте снаряды PLAYMOBIL. Не цельтесь в глаза или в лицо.

CN 警告!

- 仅供儿童在成人监护下在浅水中使用。玩具玩后请拭干。
- 仅能用PLAYMOBIL 弹射物,请勿瞄准眼睛或脸。(说明书上含有重要信息,请保留备用)

1

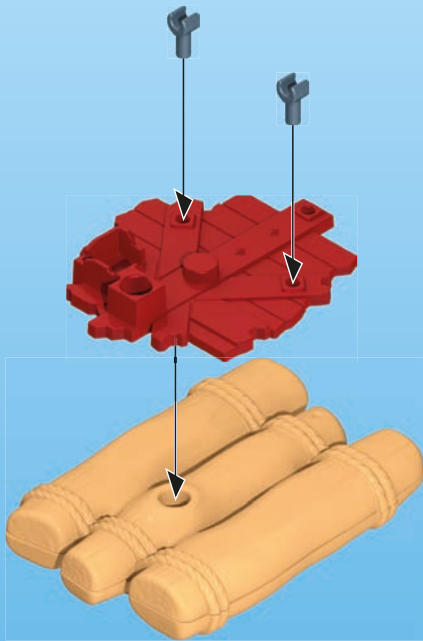

2

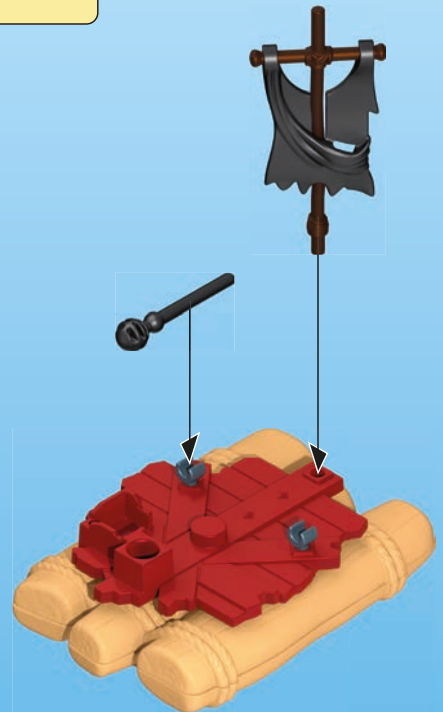

3

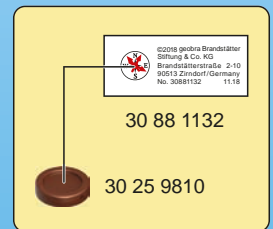
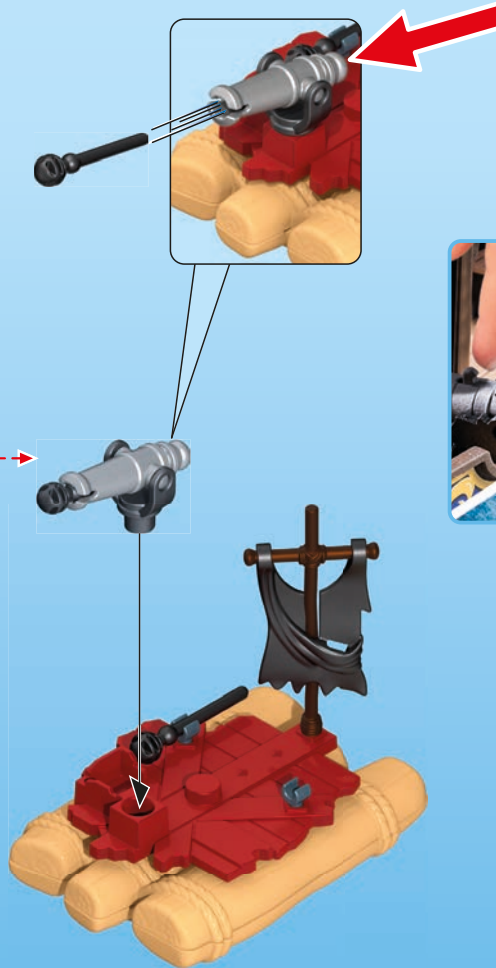
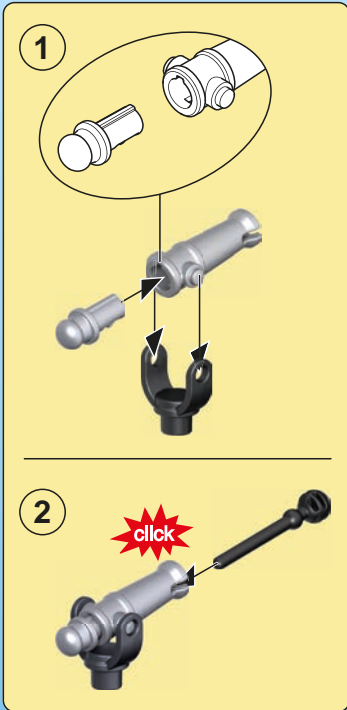

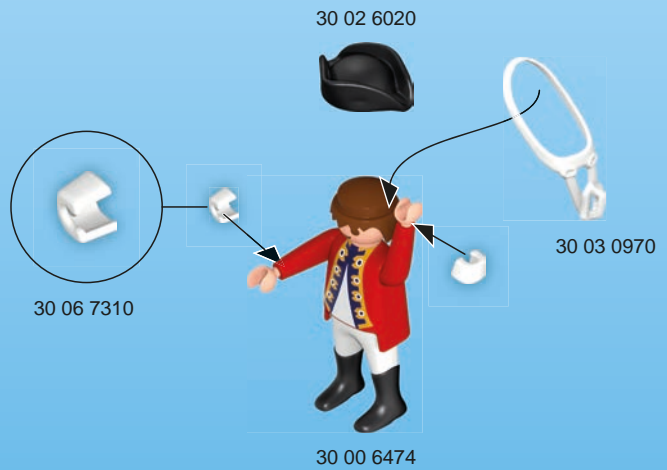
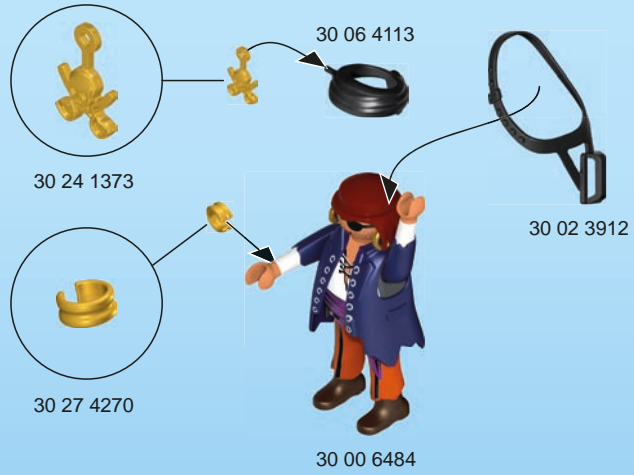
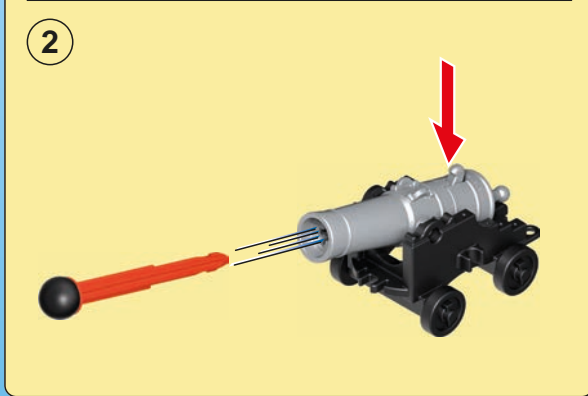
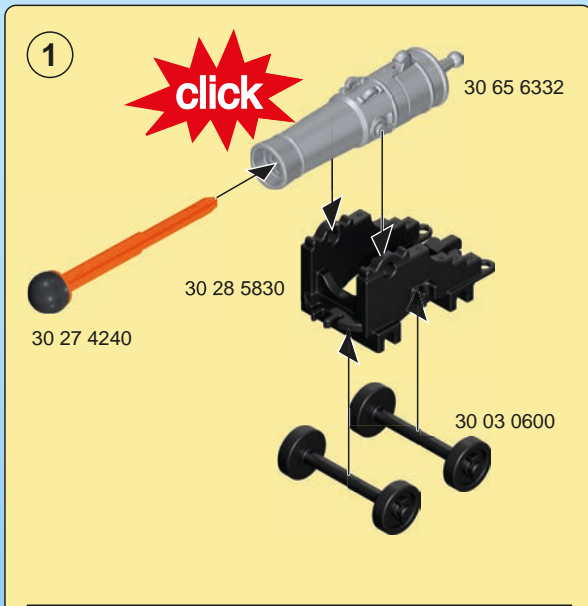

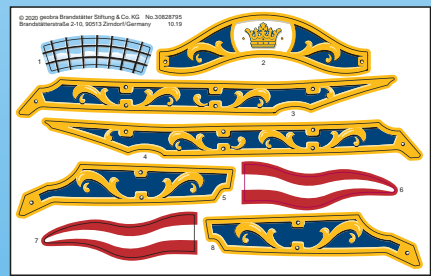
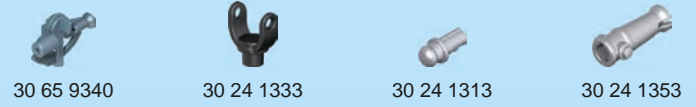
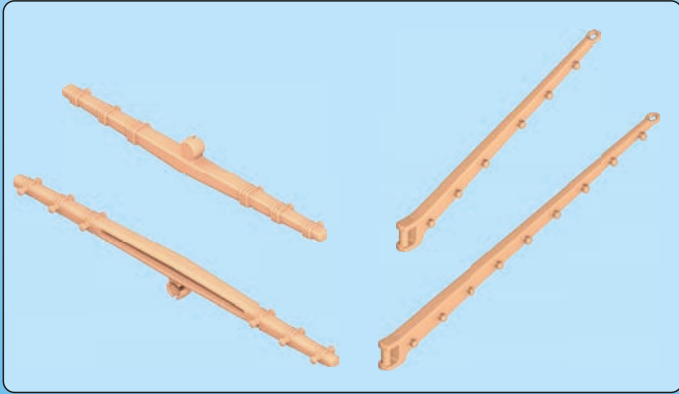
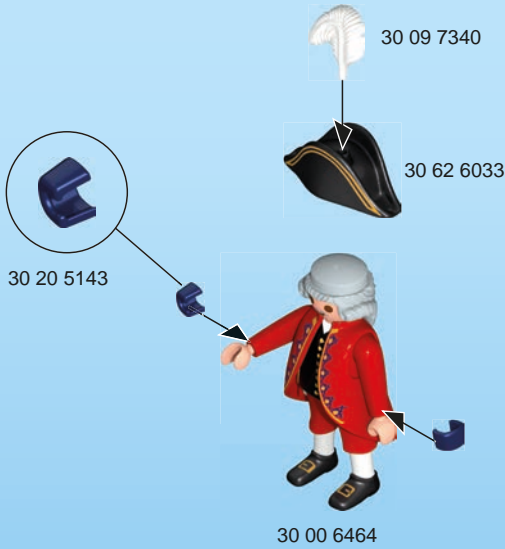



30 22 8222



30 82 8765



30 64 0406



30 06 4153



30 03 0332

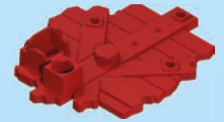

30 03 0302

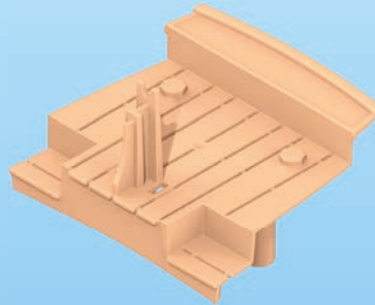

30 06 4163



30 06 4143



30 06 4133



30 65 3443



30 03 0322



30 46 6472



30 46 6282



30 06 2180



30 20 5673



30 21 8330



30 82 9755



30 27 4240



30 06 4203



30 06 4193



30 04 6853



30 28 5820



3x 30 22 8212



30 06 4183



30 21 8520



30 06 4233



30 06 4223



12x 30 28 2120



30 06 2233



2x 30 24 5722



30 06 4173



3x 30 06 4213



2x 30 22 8232

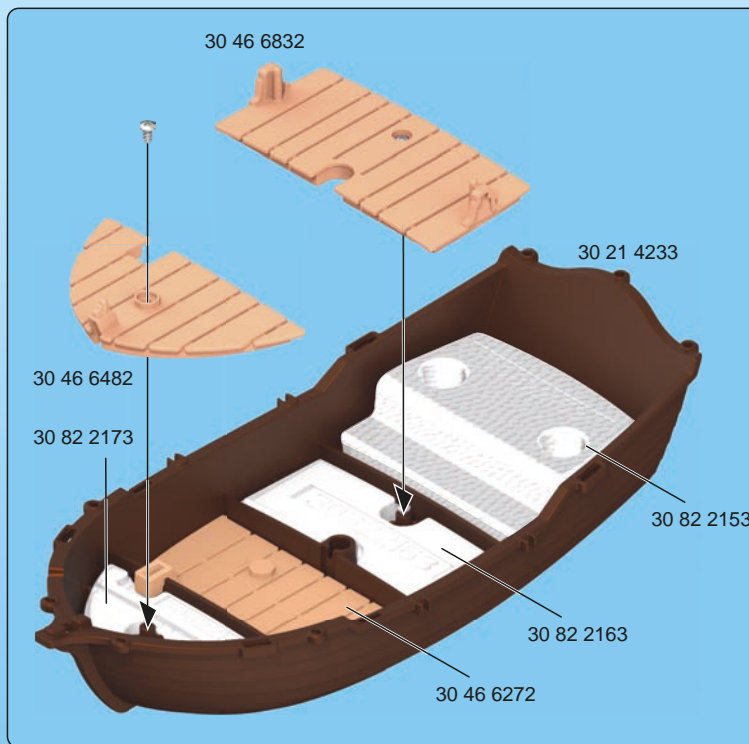

UK-Importer:
Playmobil UK Ltd.
Regency House
1 Miles Gray Road
Basildon
Essex
SS14 3RW
UK



Serviceadressen finden Sie in allen PLAYMOBIL-Prospekten

Addresses of Customer Service Departments are shown in all PLAYMOBIL catalogues

L'adresse du service consommateurs est indiquée dans tous les catalogues PLAYMOBIL

Troverete gli indirizzi dei centri di assistenza in tutti i cataloghi PLAYMOBIL

In alle PLAYMOBIL catalogi vindt u het adres van onze klantendienst.

Las Direcciones de los Departamentos de Servicio al Consumidor se encuentran en todos los catálogos PLAYMOBIL

Η διεύθυνση του Γραφείου Εξυπηρέτησης Καταναλωτών PLAYMOBIL βρίσκεται σε όλους τους καταλόγους PLAYMOBIL.

pronounced: play-mö-beil



© 2019 geobra Brandstätter Stiftung & Co.KG

Brandstätterstr. 2-10

90513 Zirndorf, Germany.

No. 30 82 9785 01.21

www.playmobil.com