

playmobil®

70280



**WARNING:**  
**CHOKING HAZARD**

Small parts. Not for children under 3 years.

"Ne concerne que les USA"

Wichtige Unterlagen, bitte sorgfältig aufbewahren!  
Important: Please keep these instructions for future reference!  
Documents importants, à conserver soigneusement!  
Belangrijke documenten, bewaar deze zorgvuldig!



1

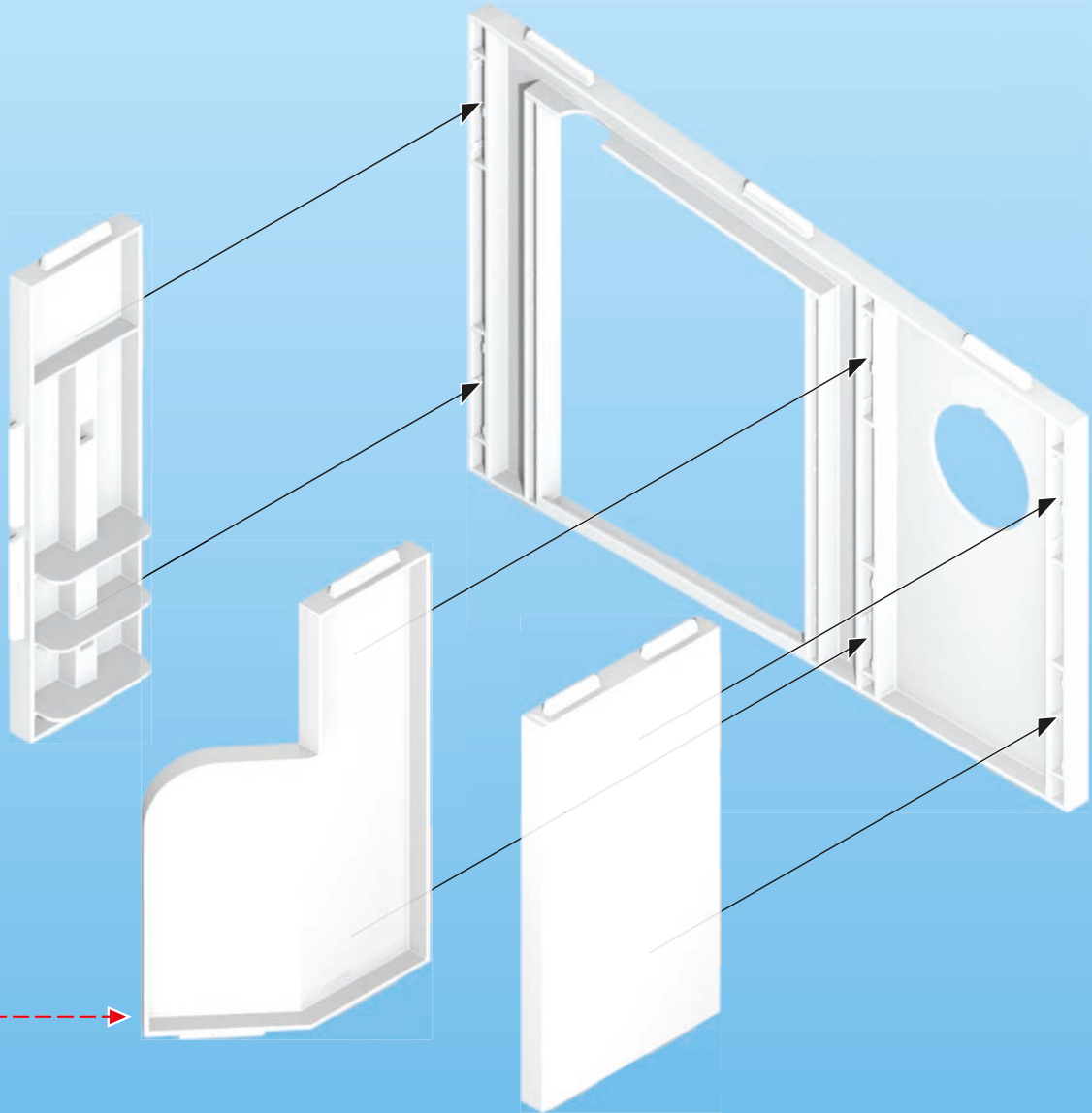

2

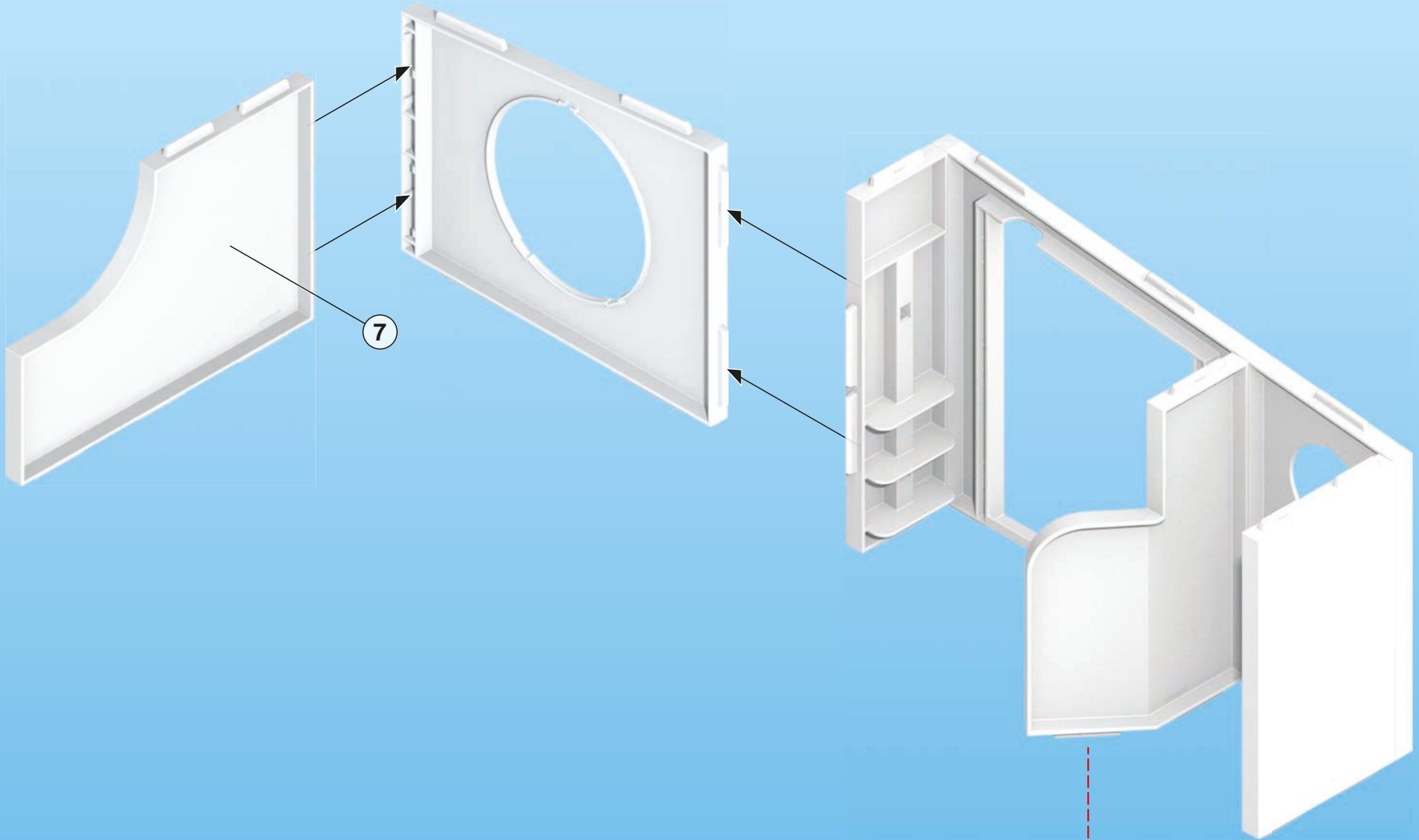



3

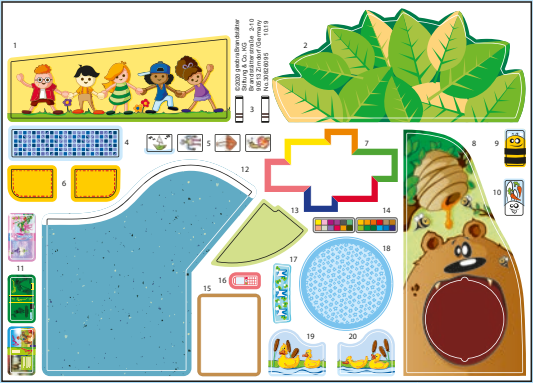

4

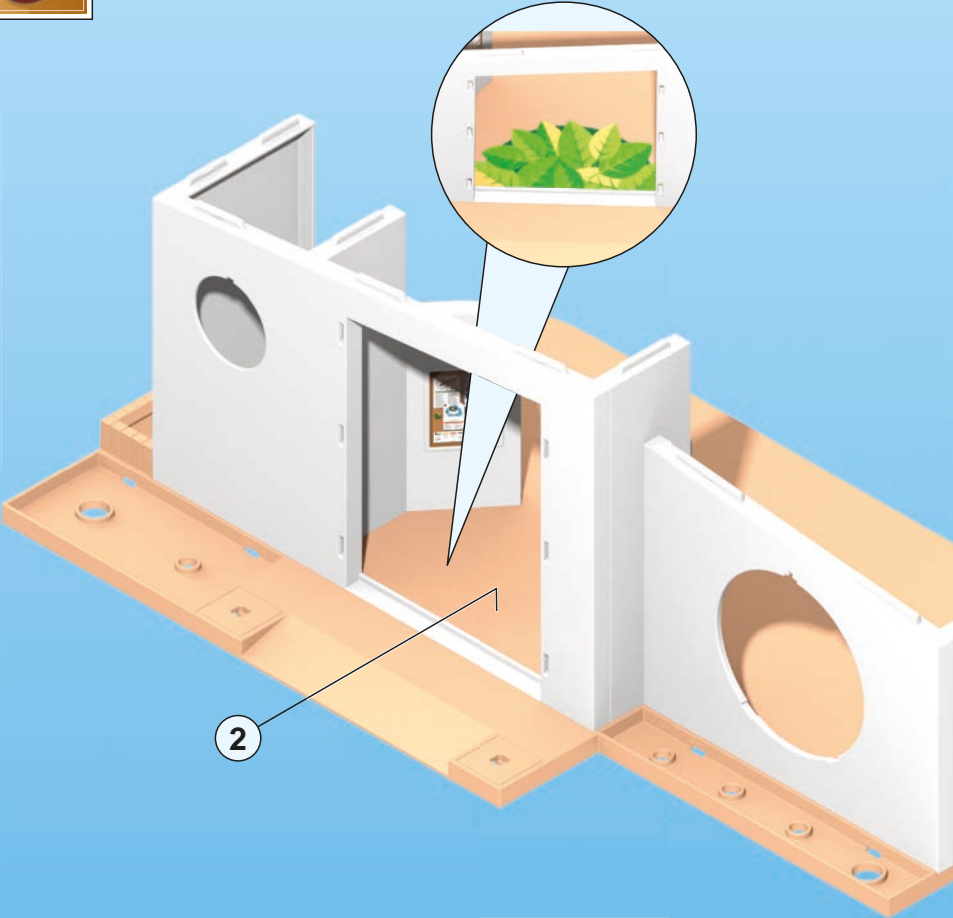
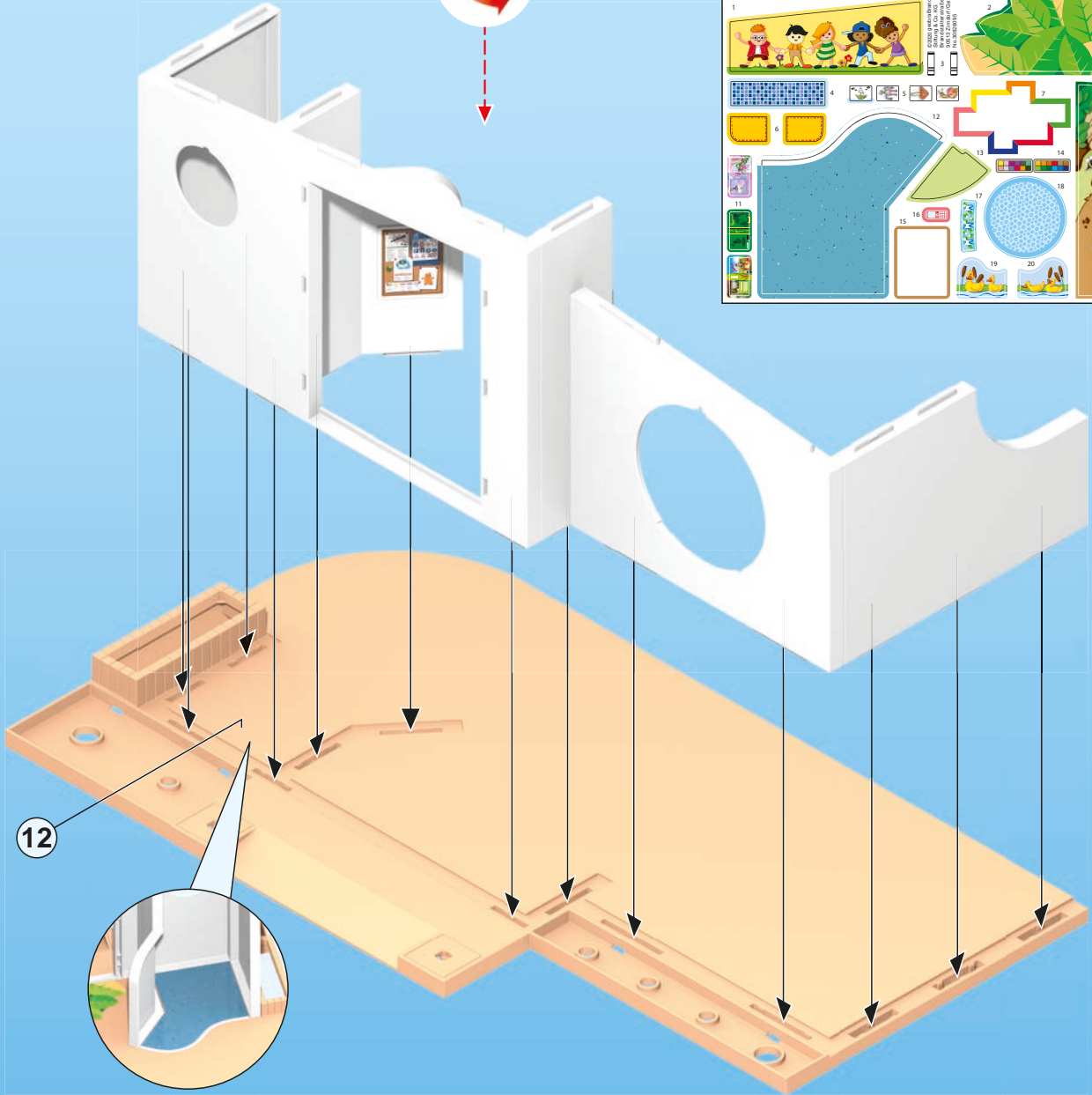



5

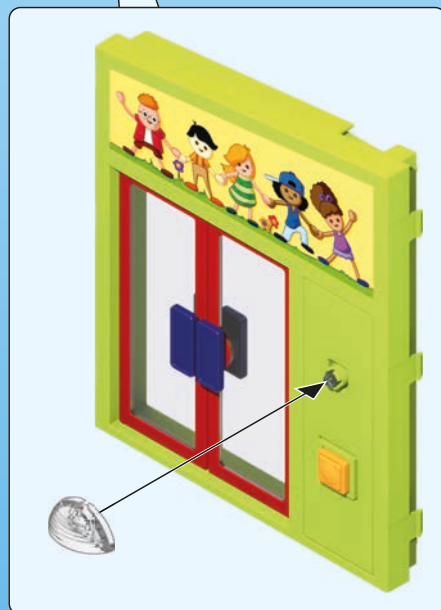
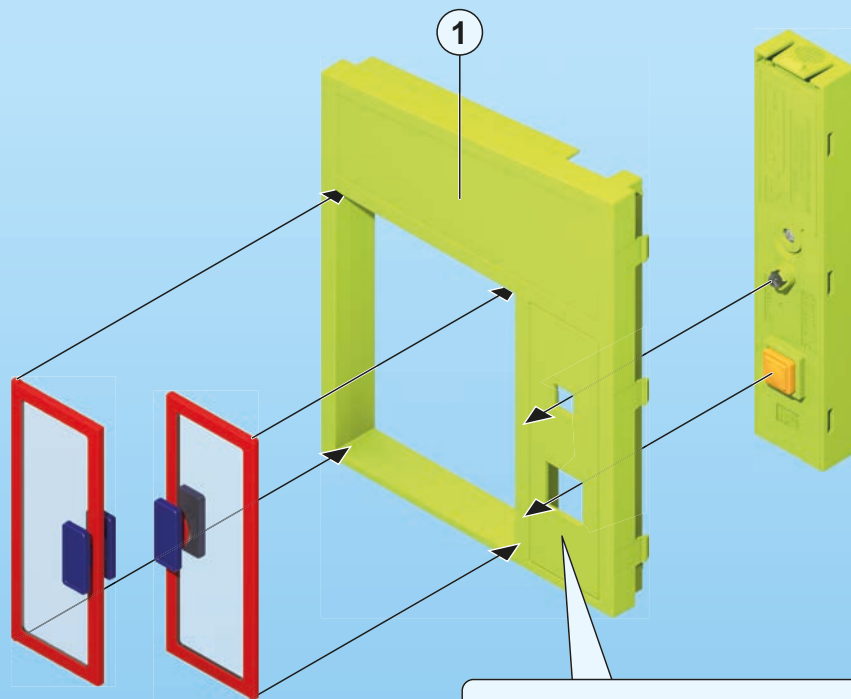
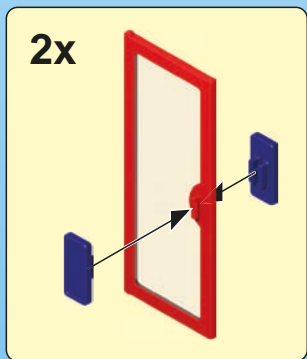
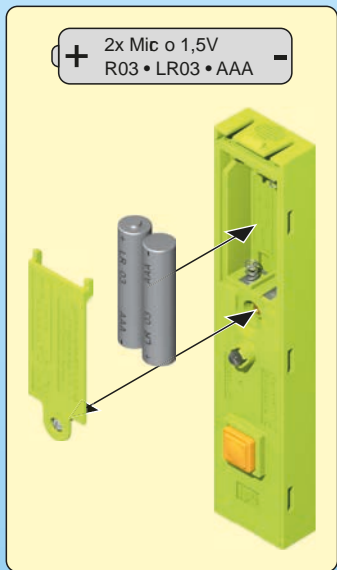

6

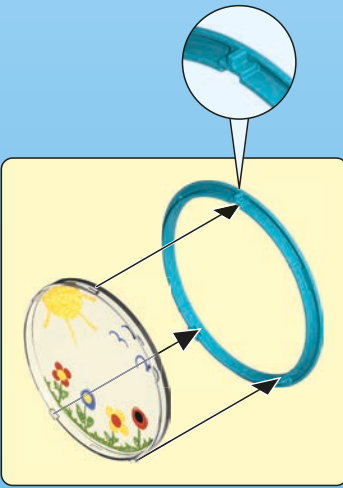
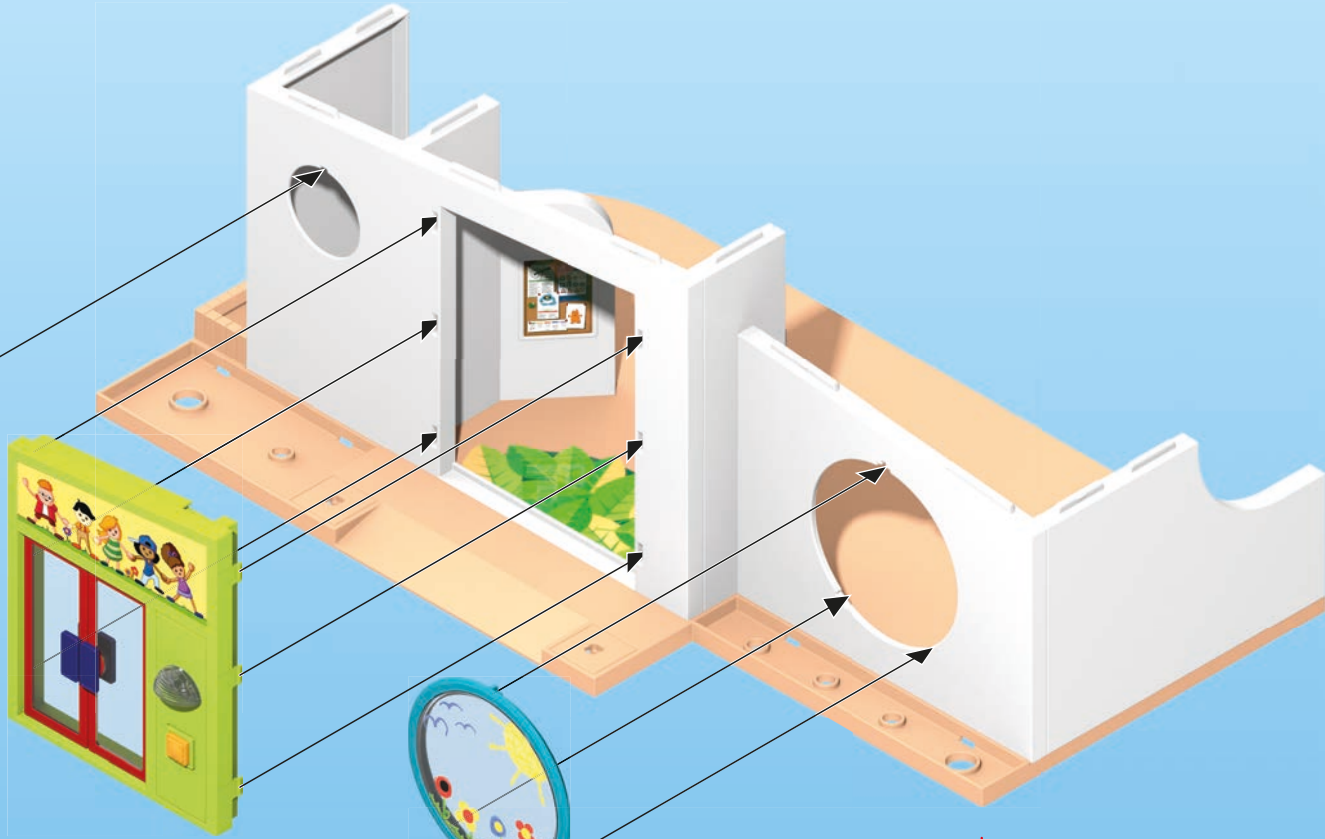
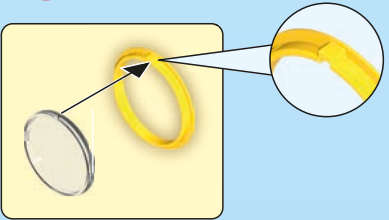

7

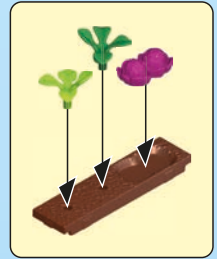
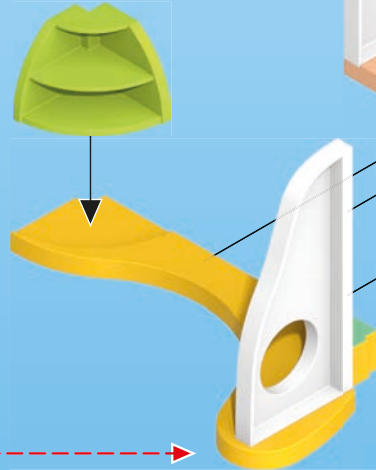
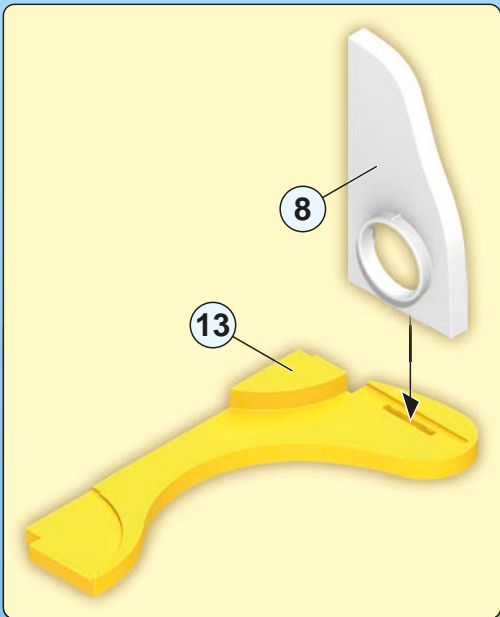
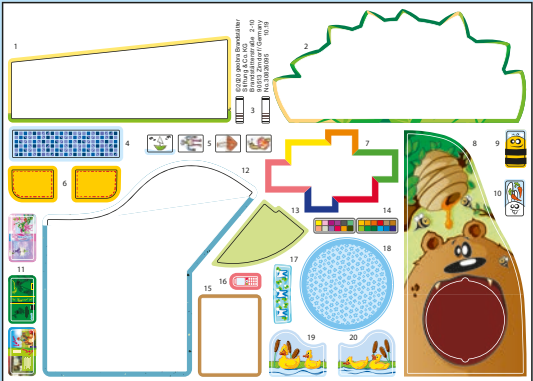



8

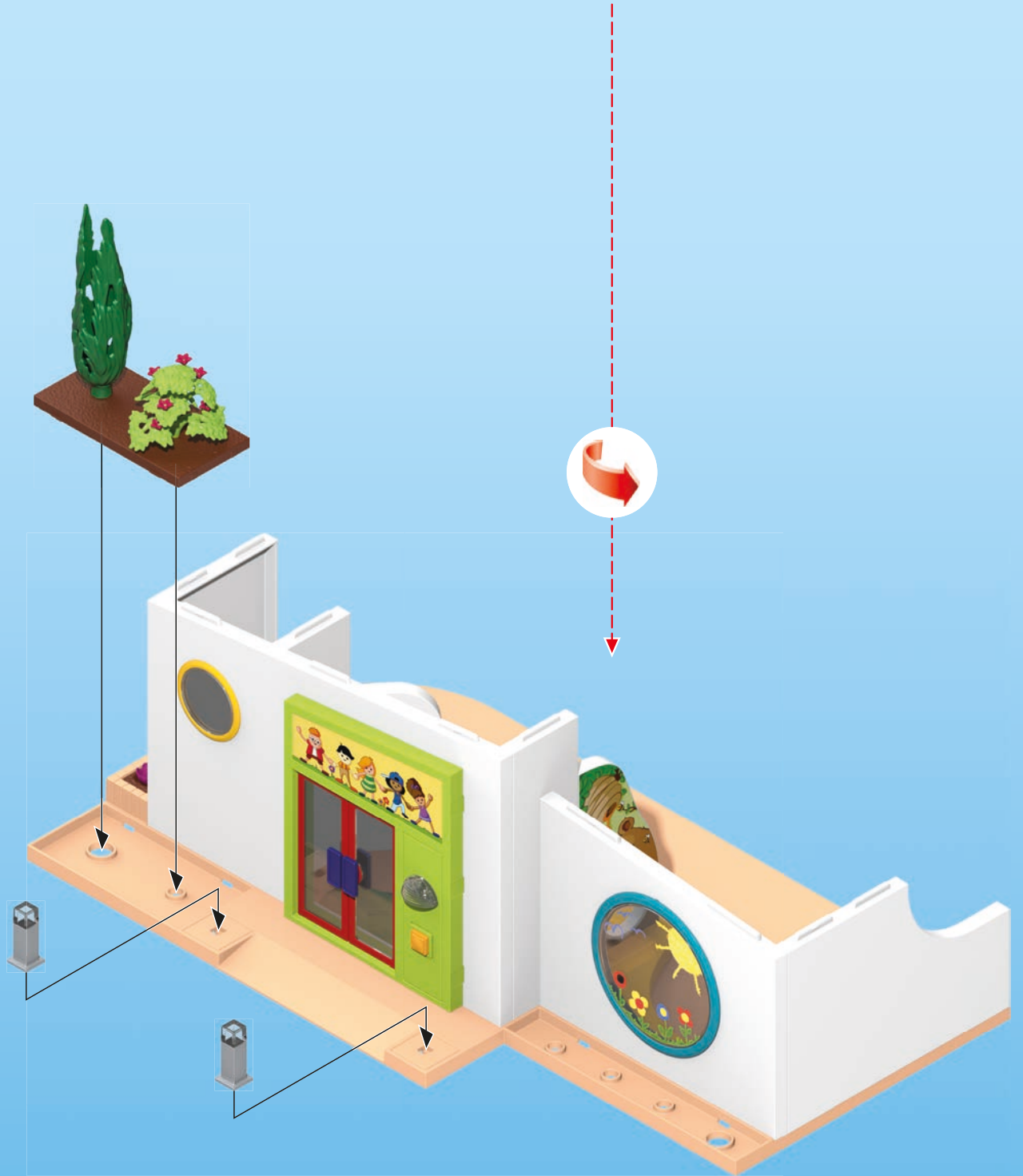
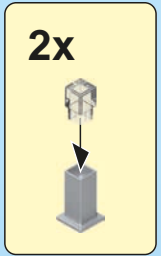
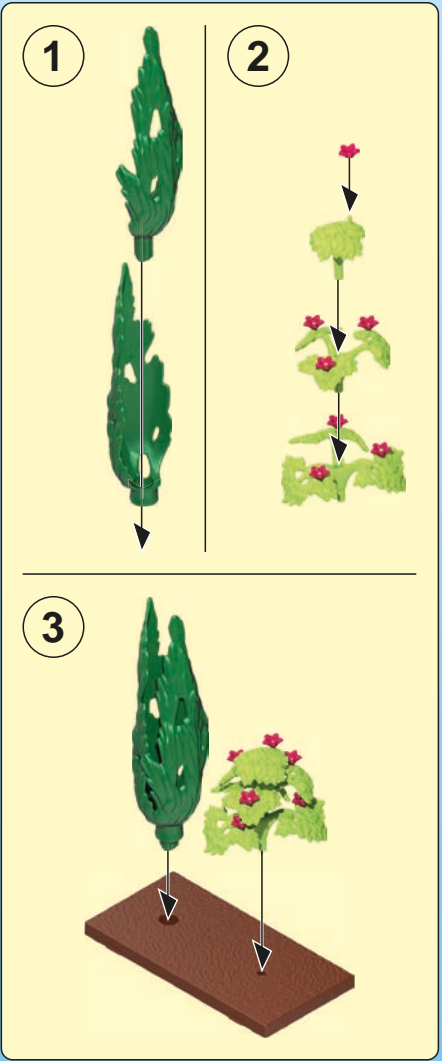

9

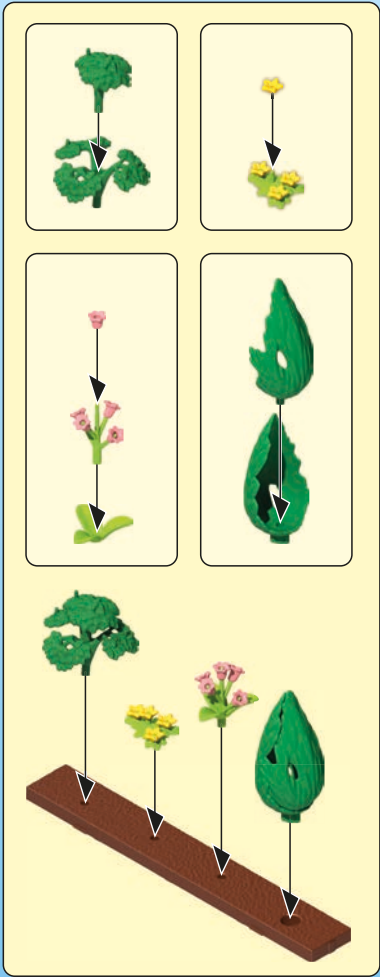

**1**

**2x**  
30 05 9223  
30 22 6393

30 21 4812

30 60 9982

**2**

30 60 9982  
30 07 1620

30 05 9233

19

20

30 21 1142

30 05 9253

4

30 05 9243

30 05 9283

6

6

© 2009 Spielhaus Bielefelder  
Spielzeug & Co. KG  
Bismarckstrasse 2-10  
D-33609 Bielefeld  
Telefon: 0521 30662995  
Fax: 0521 30662996

1

2

3

4

5

6

7

8

9

10

11

12

13

14

15

16

17

18

19

20

30 63 7035

30 21 1080

30 21 9930

30 46 4190

30 20 3350

30 64 9222

30 88 5472

30 20 0250

30 29 7070

30 09 9122

30 51 0112

30 21 1882

18

30 05 9213

30 21 5063

30 62 6715

3

30 28 7090

30 05 9133

30 62 6725

3

30 28 6820

30 05 9143

30 24 3690

9

30 51 1532

10

30 51 1542

30 05 9183

R

L

30 05 9193

30 05 9173

30 22 6173

30 22 6163

30 60 2022



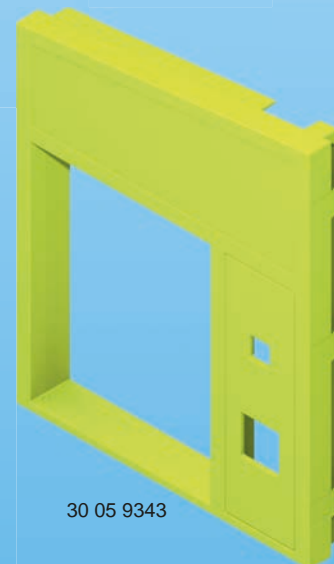
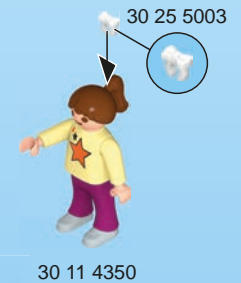
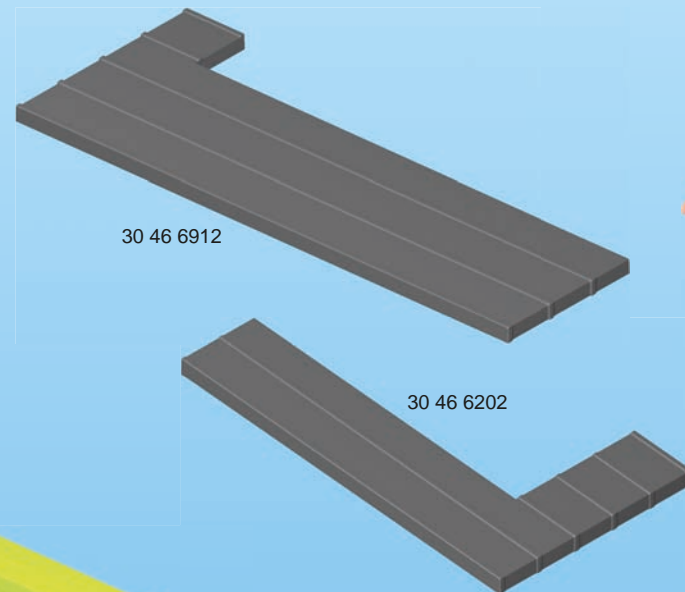
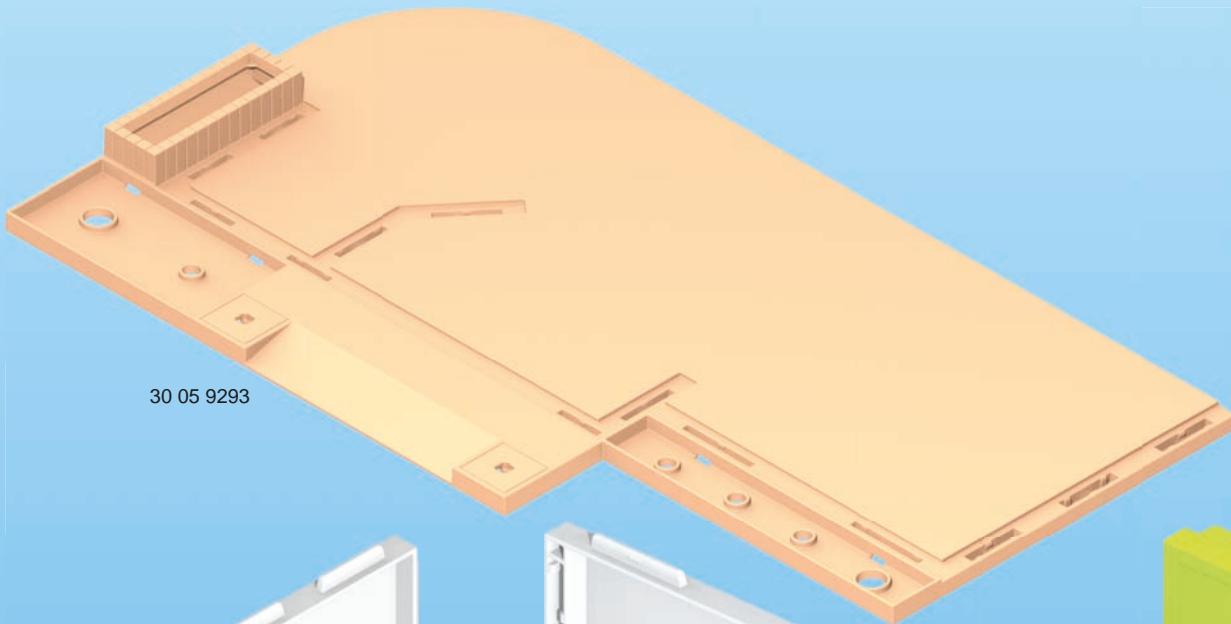
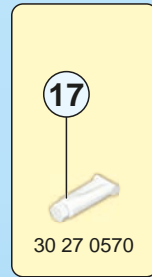
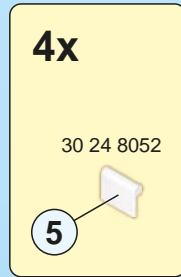
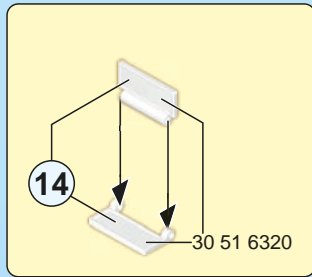
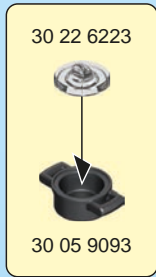



30 46 6182

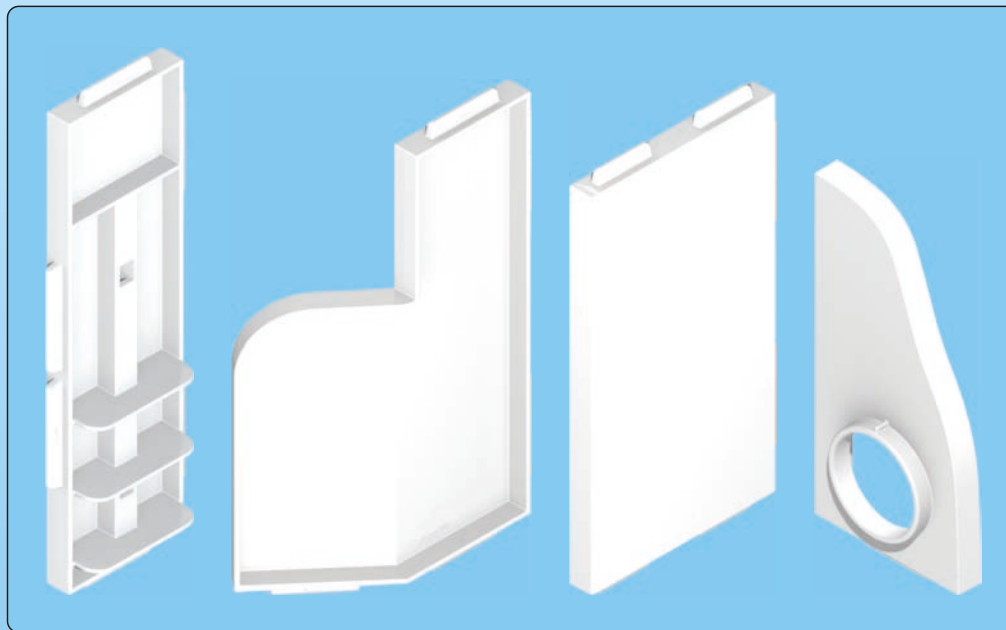

30 51 9732



30 63 7656



30 45 8800

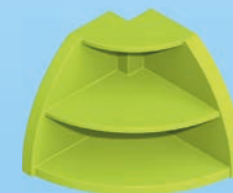

30 05 9373

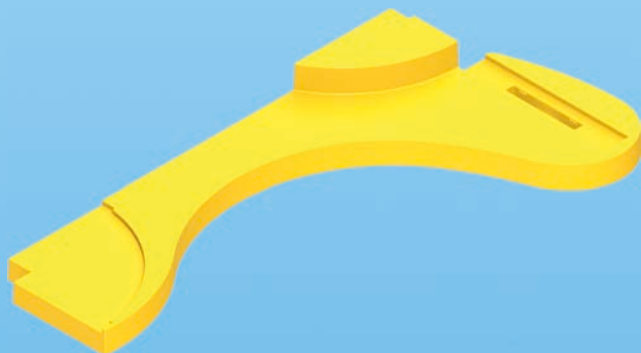

30 05 9303



2x 30 20 2942

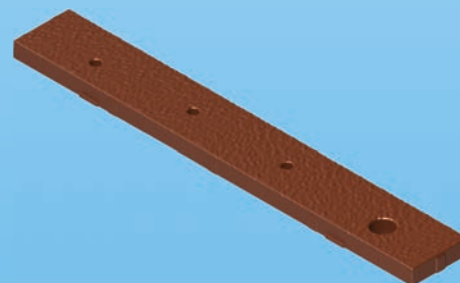

30 46 6212

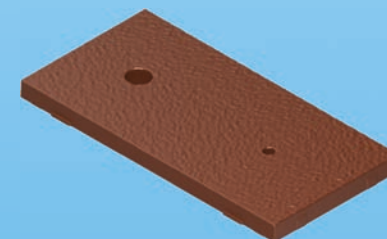

30 46 6512

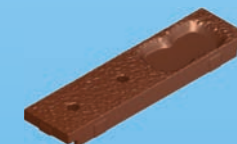

30 46 6902

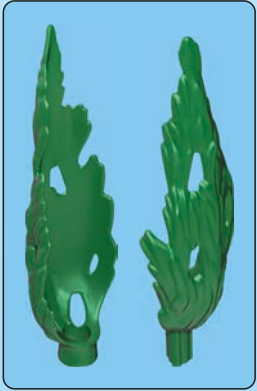

30 51 8530



30 51 8990



30 05 9273



30 23 4940



30 23 4950



30 23 4960



30 22 5780



30 22 5790



30 29 1770



30 05 9123



30 27 4260



4x 30 25 6690



4x 30 05 9203



30 89 1920



30 89 5762



30 89 1900



30 21 4742



2x 30 05 9383



30 09 2110

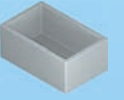

30 05 9263



30 64 1974



4x 30 05 9353



30 05 8592



2x 30 23 9583



30 05 3522



30 25 7330



30 25 7340



30 09 6840



30 25 8952



30 24 9800



30 22 6203



30 21 1862



30 05 9153



30 05 9163



3x 30 09 9032



3x 30 05 9113



30 22 6193



30 64 2184



4x 30 05 9103





30 63 7646



30 63 7636



30 63 7626



30 63 4366



4x 30 21 9293



7x 30 25 8710



5x 30 05 4182

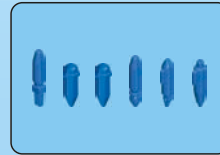

30 51 6330



30 82 6095



<p><b>DE AT CH LU BE</b> Nur angegebene Batterien verwenden. Nicht wiederaufladbare Batterien dürfen nicht geladen werden. Aufladbare Batterien dürfen nur unter Aufsicht von Erwachsenen geladen werden. Aufladbare Batterien sind aus dem Spielzeug herauszunehmen, bevor sie geladen werden. Ungleiche Batterietypen oder neue und gebrauchte Batterien dürfen nicht zusammen verwendet werden. Batterien müssen mit der richtigen Polarität eingelegt werden. Leere Batterien müssen aus dem Spielzeug herausgenommen werden. Die Anschlussklemmen dürfen nicht kurzgeschlossen werden. Batterien regelmäßig auf Auslaufen überprüfen. Verbrauchte Batterien nicht in den Hausmüll werfen, sondern nur bei den bestehenden Sammelstellen oder einem Sondermüllplatz abgeben.</p>	<p><b>LV</b> Izmantot tikai norādītās baterijas. Neuzlādēt baterijas, kuras nedrīkst atkārtoti uzlādēt. Uzlādējamas baterijas drīkst uzlādēt tikai pieaugušo uzraudzībā. Uzlādējamas baterijas pirms uzlādēšanas izņem no transportlīdzekļa. Neizmanto kopā atšķirīgu bateriju tipus vai jaunus un lietotas baterijas. Ievietojot baterijas, ievērot polaritāti. Tukšas baterijas no rotālietās jāizņem. Pieslēguma spaiļes nedrīkst pieslēgt īslēgumā. Regulāri pārbaudīt, vai baterijas nav iztecējušas. Lietotas baterijas neizmest kopā ar sadzīves atkritumiem, bet gan esošajās bateriju savākšanas vietās vai speciālā atkritumu izvešanas vietā.</p>
<p><b>US GB CA MT IE</b> Only use the stipulated batteries. Non-rechargeable batteries are not to be charged. Rechargeable batteries are only to be charged under adult supervision. Rechargeable batteries are to be removed from the toy before they are recharged. Neither different battery types nor new and used batteries are to be used together. Batteries must be inserted with the correct polarity. Flat batteries are to be removed from the toy. The connecting terminals are not to be short-circuited. Inspect batteries regularly for signs of leakage. Do not dispose of used batteries in the household waste but hand them in at the existing collection points or at a special waste site.</p>	<p><b>LT</b> Naudoti tik nurodytas baterijas. Vienkartinę baterijų įkrauti negalima. Daugkartinio naudojimo baterijos turi būti įkraunamos suaugusiųjų priežiūroje. Prieš įkraunant daugkartinio naudojimo baterijas, jas reikia išimti iš žaislo. Negalima kartu naudoti skirtingų tipų, arba naujų ir naudotų baterijų. Baterijas reikia įdėti, atsižvelgiant į teisingą poliarumą. Išsikrovusias baterijas reikia išimti iš žaislo. Negalima atlikti trumpo jungiamųjų gnybtų jungimo. Reguliariai tikrinti, ar baterijos nėra išsiverėję. Naudotų baterijų negalima išmesti kartu su buitiniams atliekomis. Jas reikia atiduoti į esamas surinkimo vietas arba į pavojingų atliekų surinkimo aikštelę.</p>
<p><b>FR CA BE LU CH</b> Seulement utiliser le modèle de piles indiqué. Ne pas recharger de piles non rechargeables. Seulement recharger des piles rechargeables en présence d'adultes. Ôter les piles rechargeables du jouet avant de les recharger. Ne pas utiliser de piles de différents types en même temps ni de piles neuves avec des piles anciennes. Attention à introduire correctement les piles en tenant compte de leur polarité. Ôter les piles usées du jouet. Ne pas court-circuiter les bornes. Vérifier régulièrement si les piles coulent. Ne pas jeter de piles usées avec les ordures ménagères, les déposer dans les centres de récupération.</p>	<p><b>SI</b> Uporabljajte le navedene baterije. Baterij, ki niso namenjene za polnjenje, ni dovoljeno polniti. Baterije, ki se jih sme polniti, je dovoljeno polniti le pod nadzorom odraslih oseb. Pred polnjenjem je baterije, ki se lahko polnijo, potrebno vzeti iz igrace. Skupaj ni dovoljeno uporabljati različnih vrst baterij ali novih in rabljenih baterij. Baterije je potrebno vstaviti pravilno obrnjene – s pravilno polariteto. Prazne baterije je potrebno vzeti iz igrace. Na priključnih sponkah ni dovoljeno povzročati kratkega stika. Redno preverjajte, ali baterije ne iztekajo. Izrabljene baterije ne odlagajte med gospodinjske odpadke, ampak jih oddajte na zbirnih mestih oz. na zbirališču posebnih odpadkov.</p>
<p><b>ES MX</b> Utiliza únicamente las pilas descritas. No recargues pilas no recargables. Recarga las pilas recargables únicamente bajo supervisión de un adulto. Saca las pilas recargables del juguete antes de recargarlas. No utilices juntas pilas de tipos diferentes ni tampoco pilas nuevas con pilas usadas. Inserta las pilas con la polaridad correcta. Saca del juguete las pilas gastadas. No pongas en cortocircuito los bornes de conexión. Comprueba periódicamente si se ha producido una fuga en las pilas. No eches las pilas gastadas a la basura doméstica, deséchalas únicamente en los puestos de recogida previstos o en un depósito de basura especial.</p>	<p><b>SK</b> Používajte len uvedené batérie. Batérie, ktoré nie sú nabíjateľné, sa nesmú nabíjať. Nabíjateľné batérie sa smú nabíjať len pod dohľadom dospelých osôb. Nabíjateľné batérie je potrebné pred nabíjaním vybrať z hračky. Nerovnaké typy batérií alebo nové a použité batérie sa nesmú spoločne používať. Batérie sa musia vložiť so správnou polaritou. Prázdne batérie sa musia z hračky vybrať von. Pripojovacie svorky sa nesmú skratovať. Batérie pravidelne kontrolujte, či nevytekajú. Používané batérie nevhádzajte do domového odpadu, ale ich odovzdajte na existujúcich zberných miestach alebo na skládke špeciálneho odpadu.</p>
<p><b>NL BE</b> Uitsluitend de aangegeven batterijen gebruiken. Niet-herlaadbare batterijen mogen niet geladen worden. Herlaadbare batterijen mogen alleen onder toezicht van volwassenen geladen worden. Opladbare batterijen moeten uit het speelgoed genomen worden vooraleer ze te laden. Ongelijke batterijtypes of nieuwe of gebruikte batterijen mogen niet samen gebruikt worden. Batterijen moeten met de correcte polen ingelegd worden. Leg de batterijen moeten uit het speelgoed genomen worden. De aansluitingsklemmen mogen niet kortgesloten worden. Regelmatig controleren of de batterijen niet uitgelopen zijn. Lege batterijen niet met het huisvuil verwijderen, maar alleen bij bestaande verzamelcentra of een plaats voor bijzondere afval afgeven.</p>	<p><b>PL</b> Stosować tylko wskazane baterie. Wyłącznie baterie, nie nadające się do powtórzenia ładowania, nie mogą być ładowane. Baterie nadające się do powtórzenia ładowania (akumulatorki) mogą być ładowane tylko pod kontrolą osób dorosłych. Przed ładowaniem baterie-akumulatorki należy wyjąć z zabawki. Nie stosować równocześnie baterii różnych typów ani baterii nowych wraz z używanymi. Podczas ładowania baterii zwrócić uwagę na ich prawidłową polaryzację. Rozładowane baterie usunąć z zabawki. Nie zwierać zacisków. Regularnie sprawdzać, czy baterie nie wyciekają. Zużytych baterii nie wyrzucać do kosza na śmieci, tylko oddać w odpowiednich punktach zbiórki lub wrzucać do przeznaczonych do tego celu specjalnych pojemników.</p>
<p><b>IT CH</b> Usare solo le batterie indicate. E' vietato utilizzare le batterie ricaricabili. Le batterie ricaricabili devono essere caricate soltanto in presenza di adulti. Le batterie ricaricabili si estraggono dal giocattolo, prima di essere caricate. I tipi di batteria non uguali o nuovi e le batterie esauste non devono essere usate insieme. Le batterie vanno inserite rispettando la corretta polarità. Le batterie esaurite devono essere rimosse dal giocattolo. I morsetti di collegamento non devono essere messi in corto circuito. Verificare ad intervalli regolari che le batterie non si siano esaurite. Le batterie esauste non vanno smaltite insieme ai rifiuti domestici, bensì portate nei punti di raccolta o nei centri di raccolta per rifiuti speciali.</p>	<p><b>TR CY</b> Yalnızca belirtilen pilleri kullanınız. Şarj edilemeyen piller şarj edilmemelidir. Şarj edilebilir piller yalnızca yetiştirkinlerin gözetiminde şarj edilmelidir. Şarj edilebilir piller, şarj edilmeden önce oyuncak içerisinde çıkarılmalıdır. Türleri birbirinden farklı piller veya yeni ve eski piller bir arada kullanılmayın. Piller kutupları doğru olacak şekilde yerleştirilmelidir. Biten piller oyuncak içerisinde çıkarılmalıdır. Bağlantı klemensleri kısa devre yapılmamalıdır. Düzeneği aralıkları pilleri aynı akumadıkları kontrol ediniz. Kullanılmış pilleri ev çöplüne atmayınız, yalnızca özel toplama yerlerine atınız veya özel atık merkezinе ulaştırınız.</p>
<p><b>PT</b> Usar apenas as pilhas indicadas. Pilhas não recarregáveis não podem ser carregadas. Pilhas recarregáveis só podem ser carregadas sob supervisão de adultos. Pilhas recarregáveis devem ser retiradas do brinquedo, antes de serem carregadas. Não se pode usar em conjunto diferentes tipos de pilha ou pilhas novas e usadas. Pilhas têm de ser inseridas com a polaridade correcta. Pilhas vazias têm de ser retiradas do brinquedo. Não se podem curto-circuitar os terminais. As pilhas têm de ser controladas regularmente quanto a vazamento. Não deitar pilhas gastas no lixo doméstico, mas depositá-las nos pontos de recolha existentes ou entregá-las no estabelecimento que as comercializa.</p>	<p><b>GR CY</b> Να χρησιμοποιείτε μόνο μπαταρίες του τύπου που σας υποδεικνύουν οι πληροφορίες ή αντίστοιχες. Ποτέ μην επαναφορτίσετε μη επαναφορτιζόμενες μπαταρίες. Οι επαναφορτιζόμενες μπαταρίες πρέπει να επαναφορτίζονται πάντα από ενήλικα. Αφαιρέτε τις επαναφορτιζόμενες μπαταρίες από την ηλεκτρονική μονάδα του παιχνιδιού πριν τις επαναφορτίσετε. Μην συνδυάζετε μπαταρίες διαφορετικών τύπων, π.χ. αλκαλικές ή επαναφορτιζόμενες με απλές, ή παλιές με καινούριες. Τοποθετήστε τις μπαταρίες με την σωστή πολικότητα. Όταν αδειάζουν οι μπαταρίες πρέπει να απομακρύνονται από το παιχνίδι. Ποτέ μη βραχυκυκλώνετε τους πόλους. Πάντα να ελέγχετε τις μπαταρίες για τυχόν διαρροές. Μην πετάτε ποτέ στα οικιακά απορρίμματα τις παλιές μπαταρίες, παρά μόνο σε ειδικούς κάδους ανακύκλωσης με την αντίστοιχη ένδειξη. Για τον κατάλληλο τρόπο ανακύκλωσης, παρακαλούμε επικοινωνήστε με τους τοπικούς φορείς.</p>
<p><b>DK</b> Anvend kun de angivne batterier. Ikke genopladelige batterier må ikke oplades. Genopladelige batterier må kun oplades under opsyn af voksne. Genopladelige batterier skal tages ud af legetøjet, inden de oplades. Forskellige batterityper eller nye og brugte batterier må ikke anvendes sammen. Batterier skal isættes med den rigtige polaritet. Tomme batterier skal tages ud af legetøjet. Tilslutningsklemmerne må ikke kortsluttes. Kontroller regelmæssigt batterierne for lækage. Obrugte batterier må ikke bortskaffes som almindeligt husholdningsaffald, men skal afleveres på et officielt sted for indsamling af brugte batterier eller på den kommunale genbrugsstation.</p>	<p><b>RO</b> Se vor folosi doar bateriile specificate. Bateriile fără reîncărcare nu au voie să se încarce. Bateriile reîncărcabile se vor încărca doar sub supravegherea adulţilor. Bateriile reîncărcabile se scot din jucărie înainte de încărcare. Nu este permisă utilizarea împreună a bateriilor de tipuri diferite sau a bateriilor noi cu cele vechi. Bateriile trebuie introduse cu polaritatea corectă. Bateriile descărcate trebuie scoase din jucărie. Bornele nu au voie să fie scurtcircuitate. Bateriile trebuie verificate în mod regulat să nu prezinte scurgeri. Bateriile consumate nu se aruncă la deşeurile menajere, ci se predau la centrele existente de colectare sau în locurile pentru deşeuri speciale.</p>
<p><b>NO</b> Benytt kun angitte batterier. Batterier som ikke gjenopplades må ikke lades opp. Opladbare batterier må bare lades opp under tilsyn av voksne. Opladbare batterier må tas ut av leketøyet før de lades opp. Ulike batterityper eller nye og brukte batterier må ikke benyttes sammen. Batterier må legges inn med riktig polaritet. Tomme batterier må tas ut av kjøretøyet. Kopplingsklemmene må ikke kortsluttes. Kontroller batteriene regelmessig for om de lekker ut. Ikke kast oppbrukte batterier i husholdningsavfallet, men lever dem til lokale miljøstasjoner eller til en plass for spesialavfall.</p>	<p><b>BG</b> Използвайте само посочените батерии. Непредназначени за зареждане батерии не бива да бъдат зареждани. Зареждащите се батерии трябва да бъдат зареждани само под надзора на възрастни. Зареждащите се батерии се изваждат от играчката, преди да се поставят за зареждане. Не използвайте заедно нееднакви модели батерии и нови и употребявани батерии не бива да се използват заедно. Поставяйте батериите, обръщайки внимание на правилния поляритет. Празните батерии трябва да бъдат изваждани от играчката. Съвързащите клеми не трябва да бъдат давани на късо. Редовно проверявайте батериите за течове. Не изхвърляйте употребяваните батерии като домакински отпадък, а ги предавайте само на специално определените за това места или в депо за специални отпадъци.</p>
<p><b>SE FI</b> Använd endast angivna batterier. Batterier som inte är uppladdbara får inte laddas. Uppladdbara batterier får endast laddas om en vuxen person hjälper dig. Ta ur de uppladdbara batterierna ur fordonet innan de laddas. Använd inte olika batterityper samtidigt, använd heller inte ett nytt och ett gammalt batterie samtidigt. Se till att batterierna ligger åt rätt håll, det finns symboler på batterierna och i batterifacket. Ta ur tomma batterier ur lekseten. Lagg inte ihop anslutningsklämmorna, de kan bli kortslutning. Kontrollera regelbundet att batterierna inte läcker batterisyra. Gamla batterier hör inte hemma i vanliga hushållsoppor. Kasta batterier i speciella batteriuppsamlare eller lämna dem till soptippen som specialavfall.</p>	<p><b>HR</b> Koristiti samo navedene baterije. Baterije za ponovno punjenje se ne smiju koristiti. Baterije za ponovno punjenje se smiju puniti samo pod nadzorom odraslih. Baterije za ponovno punjenje se prije punjenja moraju izvaditi iz igracke. Baterije raznih tipova ili nove i rabljene se ne smiju skupa uporabljavati. Baterije se moraju umetnuti sa tocnim polaritetom. Prazne baterije se moraju izvaditi iz igracke. Priključne stazaljke se ne smiju kratko spojati. Baterije redovito provjeravati u svezi curenja. Istrošene baterije ne bacati u kućno smeće, već ove odnijeti na postojeća sabirna mjesta ili predati na jedno mjesto za posebno smeće.</p>
<p><b>FI</b> Käytä vain ilmoitettuja paristoja. Ei saa ladata paristoja, jotka eivät ole ladattavia. Ladattavat paristot saa ladata vain aikuisen valvonnassa. Ladattavat paristot on poistettava leikkialueista ennen lataamista. Erilaisia paristotyyppejä tai uusia ja käytettyjä paristoja ei saa käyttää yhdessä. Paristot on asetettava paikoilleen navat oikein päin. Tyhjät paristot on poistettava leikkialueista. Liittimien oikosulku ei ole sallittua. Tarkista säännöllisesti, että paristot eivät vuoda. Älä heitä käytettyjä paristoja talousjätteeseen, vain toimita ne vain asiankuuluvien keräyspisteisiin tai ongelmajätteenpajalleen.</p>	<p><b>RU</b> Используйте только указанные батареи. Неперезаряжаемые батарейки не следует заряжать. Перезаряжаемые батарейки можно заряжать только под присмотром взрослых. Перед зарядкой перезаряжаемых батареек следует извлечь их из игрушки. Различные типы батареек или новые и использованные батарейки не должны использоваться вместе. Батарейки следует вставлять с учетом правильной полярности. Разряженные батарейки следует извлечь из игрушки. Не допускайте короткого замыкания соединительных клемм. Регулярно проверяйте батареи на предмет износа. Не выбрасывайте использованные батарейки в бытовые отходы, а утилизируйте их только в соответствующих пунктах сбора или в месте для утилизации специальных видов отходов.</p>
<p><b>HU</b> Csak a megadott elemeket szabad használni. A nem tölthető elemek töltése tilos. A tölthető elemeket csak felnőttek felügyelete mellett szabad tölteni. A feltölthető elemeket ki kell venni a játékból a töltés előtt. Nem egyforma típusú elemek, vagy új és használt elemek együtt nem használhatók. Az elemeket a megfelelő polaritással kell behelyezni. A lemerült elemeket ki kell venni a játékból. A csatlakozó kapcsokat nem szabad rövidre zární. Rendszeresen ellenőrizni kell, hogy az elemek nem folynak-e. A használt elemeket nem szabad a háztartási szeméttbe dobni, hanem le kell adni egy gyűjtőhelyen vagy veszélyes hulladék állomáson.</p>	<p><b>CN</b> 只限使用规定的电池类型。非充电电池不能充电。充电电池只能在成年人监督下充电！充电电池在充电前应该从玩具中取出。不同类型的电池或新旧电池不能混用！电池应以正确的极性放入。用尽的电池应从玩具中取出。电源端子不得短路。用过的旧电池请勿随意丢弃在家庭垃圾中，而是放入回收站或者交给特殊处理处。（说明书上含有重要信息，请保留备用）</p>
<p><b>CZ</b> Používejte pouze uvedené baterie. Baterie, které není možno dobíjet, nesmějí být nabíjeny. Nabíjecí baterie smějí být nabíjeny pouze pod dohledem dospělých osob. Nabíjecí baterie musejí být před nabitím vyjmuty z hračky. Různé typy baterií nebo nové a použité baterie nesmějí být použity společně. Je nutno vložit baterie se stejnou polaritou. Prázdné baterie je nutno z hračky vyndat. Pripojovací svorky nesmějí být spojeny nakrátko. Pravidelně kontrolujte, zda baterie nevytékají. Použité baterie neházejte do domovního odpadu, pouze je odevzdejte na stávající sběrná místa nebo stanoviště pro nebezpečný odpad.</p>	<p><b>EE</b> Kasutage ainult lubatud patareisid. Laadimisvõimaluseta patareisid on keelatud laadida. Laadimisvõimalusega patareisid tohib laadida ainult täiskasvanud isiku järelevalvel. Laadimisvõimalusega patareid tuleb enne laadimise alustamist mänguasja seest välja võtta. Ärge kasutage korraga erinevat tüüpi või uusi ja kasutatud patareisid. Jälgige patareide paigaldamisel õiget polaarsust. Tühjad patareid tuleb mänguasja seest välja võtta. Uhendusklemmide lühistamine on keelatud. Kontrollige patareisid regulaarselt, et nad ei eraldaks vedelikku. Ärge visake kasutuskohtamatuid patareisid majapidamisprügi hulka vaid andke need vastavatesse kogumiskohadesse või ohtlike jäätmete kogumiskohadesse.</p>





**DE AT CH LU BE Denken Sie an den Schutz der Umwelt !**

- Ihr Gerät enthält wertvolle Rohstoffe, die wieder verwertet werden können.
- Geben Sie Ihr Gerät deshalb bitte bei einer Sammelstelle Ihrer Stadt oder Gemeinde ab.

**GB MT IE Environment protection first !**

- Your appliance contains valuable materials which can be recovered or recycled.
- Leave it at a local civic waste collection point.

**FR LU CH Participons à la protection de l'environnement !**

- Votre appareil contient de nombreux matériaux valorisables ou recyclables.
- Confiez celui-ci dans un point de collecte pour que son traitement soit effectué.

**ES ¡¡ Participe en la conservación del medio ambiente !!**

- Su electrodoméstico contiene materiales recuperables y/o reciclables.
- Entréguelo al final de su vida útil, en un Centro de Recogida Específico o en uno de nuestros Servicios Oficiales Post Venta donde será tratado de forma adecuada.

**NL BE Samen het milieu beschermen !**

- Uw product bevat meerdere recycleerbare materialen
- Breng deze naar een afval-inzamelpunt.

**BE Participons à la protection de l'environnement !**

- Votre appareil contient de nombreux matériaux valorisables ou recyclables.
- Confiez celui-ci dans un point de collecte ou à défaut dans un centre service agréé pour que son traitement soit effectué.

**IT CH Partecipiamo alla protezione dell'ambiente !**

- Il vostro apparecchio è composto da diversi materiali che possono essere riciclati.
- Lasciatelo in un punto di raccolta o presso un Centro Assistenza Autorizzato.

**PT Protecção do ambiente em primeiro lugar!**

- O seu produto contém materiais que podem ser recuperados ou reciclados.
- Entregue-o num ponto de recolha para possibilitar o seu tratamento.

**DK Vi skal alle være med til at beskytte miljøet!**

- Apparater indeholder mange materialer, der kan genvindes eller genbruges.
- Bring det til et specialiseret indsamlingssted for genbrug eller et autoriseret serviceværksted, når det ikke skal bruges mere.

**SE FI Var rädd om miljön!**

- Din apparat innehåller olika material som kan återanvändas eller återvinnas.
- Lämna den på en återvinningsstation eller på en auktoriserad serviceverkstad för omhändertagande och behandling.

**FI Huolehtikaamme ympäristöstä!**

- i Laitteesi on varustettu monilla arvokkailla ja kierrätettävillä materiaaleilla.
- Toimita laitteesi keräyspisteeseen tai sellaiseen puuttuessa vaikka valtuutettuun huoltokekkeseen, jotta laitteen osat varmasti kierrätetään.

**HU Első a környezetvédelem!**

- Az Ön terméke értékes újrahaznosítható anyagokat tartalmaz.
- Kérjük készülékét ne dobja ki, hanem adja le az erre a célra kijelölt gyűjtőhelyen.

**CZ Podílejme se na ochraně životního prostředí!**

- Váš přístroj obsahuje četné zhodnotitelné nebo recyklovatelné materiály.
- Svěťte jej sběrnému místu nebo, neexistuje-li, smluvnímu servisnímu středisku, kde s ním bude naloženo odpovídajícím způsobem.

**SI Sodelujmo pri varovanju okolja!**

- Vaš aparat vsebuje številne dele, ki imajo svojo vrednost ali jih je še mogoče uporabiti.
- Oddajte ga na mestu za zbiranje odpadkov ali pa na pooblaščenem servisu, da bo šel v predelavo.

**SK Podieľajme sa na ochrane životného prostredia!**

- Váš prístroj obsahuje četné zhodnotiteľné alebo recyklovateľné materiály.
- Zverte ho sbornému miestu alebo, ak neexistuje, zmluvnému servisnému stredisku, kde s ním bude naložené zodpovedajúcim spôsobom.

**PL Bierzmy czynny udział w ochronie środowiska!**

- Twoje urządzenie jest zbudowane z materiałów, które mogą być poddane ponownemu przetworzeniu lub recyklingowi.
- W tym celu należy je dostarczyć do wyznaczonego punktu zbiórki.

**GR CY Ας συμβάλουμε κι εμείς στην προστασία του περιβάλλοντος!**

- Η συσκευή σας περιέχει πολλά αξιοποιήσιμα ή ανακυκλώσιμα υλικά.
- Παραδώστε την παλιά συσκευή σας σε κέντρο διαλογής ή σε ένα εξουσιοδοτημένο κατάστημα σέρβις.

**RO Țineți cont de protecția mediului !**

- Aparatul dvs. conține materii prime valoroase care pot fi revalorificate.
- Din acest motiv vă rugăm să predați aparatul dvs. la un centru de colectare din orașul sau comuna dvs.

**BG Мислете за околната среда !**

- Вашият уред съдържа ценни суровини, които могат да бъдат рециклирани.
- Затова върнете своя електроуред на специално място за събиране на такива отпадъци във Вашия град или община.

**US**

**NOTE:** This equipment has been tested and found to comply with the limits for a Class B digital device, pursuant to part 15 of the FCC Rules. These limits are designed to provide reasonable protection against harmful interference in a residential installation. This equipment generates, uses and can radiate radio frequency energy and, if not installed and used in accordance with the instructions, may cause harmful interference to radio communications. However, there is no guarantee that interference will not occur in a particular installation. If this equipment does cause harmful interference to radio or television reception, which can be determined by turning the equipment off and on, the user is encouraged to try to correct the interference by one or more of the following measures:

- Reorient or relocate the receiving antenna.
- Increase the separation between the equipment and receiver.
- Connect the equipment into an outlet on a circuit different from that to which the receiver is connected.
- Consult the dealer or an experienced radio/TV technician for help.

**PLAYMOBIL USA, INC.**  
 26 Commerce Drive  
 Cranbury, NJ 08512  
 Phone 1-800-752-9662 or 609-395-5566  
 Email: service@playmobilusa.com

**Caution:** Changes or modifications not expressly approved by the party responsible for compliance could void the user's authority to operate the equipment.

**US**

This device complies with Part 15 of the FCC Rules. Operation is subject to the following two conditions:  
 (1) This device may not cause harmful interference, and  
 (2) this device must accept any interference received, including interference that may cause undesired operation.

**CA**

**CAN ICES-3 (B)/NMB-3(B)**

Cet équipement est conforme à la Section 15 des règlements de la FCC. Son fonctionnement est soumis aux deux conditions suivantes:  
 (1) Cet équipement ne peut causer d'interférence nuisible, et  
 (2) cet équipement doit pouvoir fonctionner même s'il capte de l'interférence, incluant celle pouvant provoquer un fonctionnement indésirable.

Serviceadressen finden Sie in allen PLAYMOBIL-Prospekten

Addresses of Customer Service Departments are shown in all PLAYMOBIL catalogues

L'adresse du service consommateurs est indiquée dans tous les catalogues PLAYMOBIL

Troverete gli indirizzi dei centri di assistenza in tutti i cataloghi PLAYMOBIL

In alle PLAYMOBIL catalogi vindt u het adres van onze klantendienst.

Las Direcciones de los Departamentos de Servicio al Consumidor se encuentran en todos los catálogos PLAYMOBIL

Η διεύθυνση του Γραφείου Εξυπηρέτησης Καταναλωτών PLAYMOBIL βρίσκεται σε όλους τους καταλόγους PLAYMOBIL.

pronounced: plāy-mō-bēēl

**UK-Distributor:**  
**Playmobil UK Ltd.**  
**Regency House**  
**1 Miles Gray Road**  
**Basildon**  
**Essex**  
**SS14 3RW**  
**UK**



Abbildungen können vom Original abweichen. / Product may differ from image shown.  
 Les illustrations peuvent différer de l'original. / Afbeeldingen kunnen verschillen van het werkelijke artikel.

