



WARNING:
CHOKING HAZARD

Small parts. Not for children under 3 years.

"Ne concerne que les USA"

Wichtige Unterlagen, bitte sorgfältig aufbewahren!
Important: Please keep these instructions for future reference!
Documents importants, à conserver soigneusement!
Belangrijke documenten, bewaar deze zorgvuldig!



1

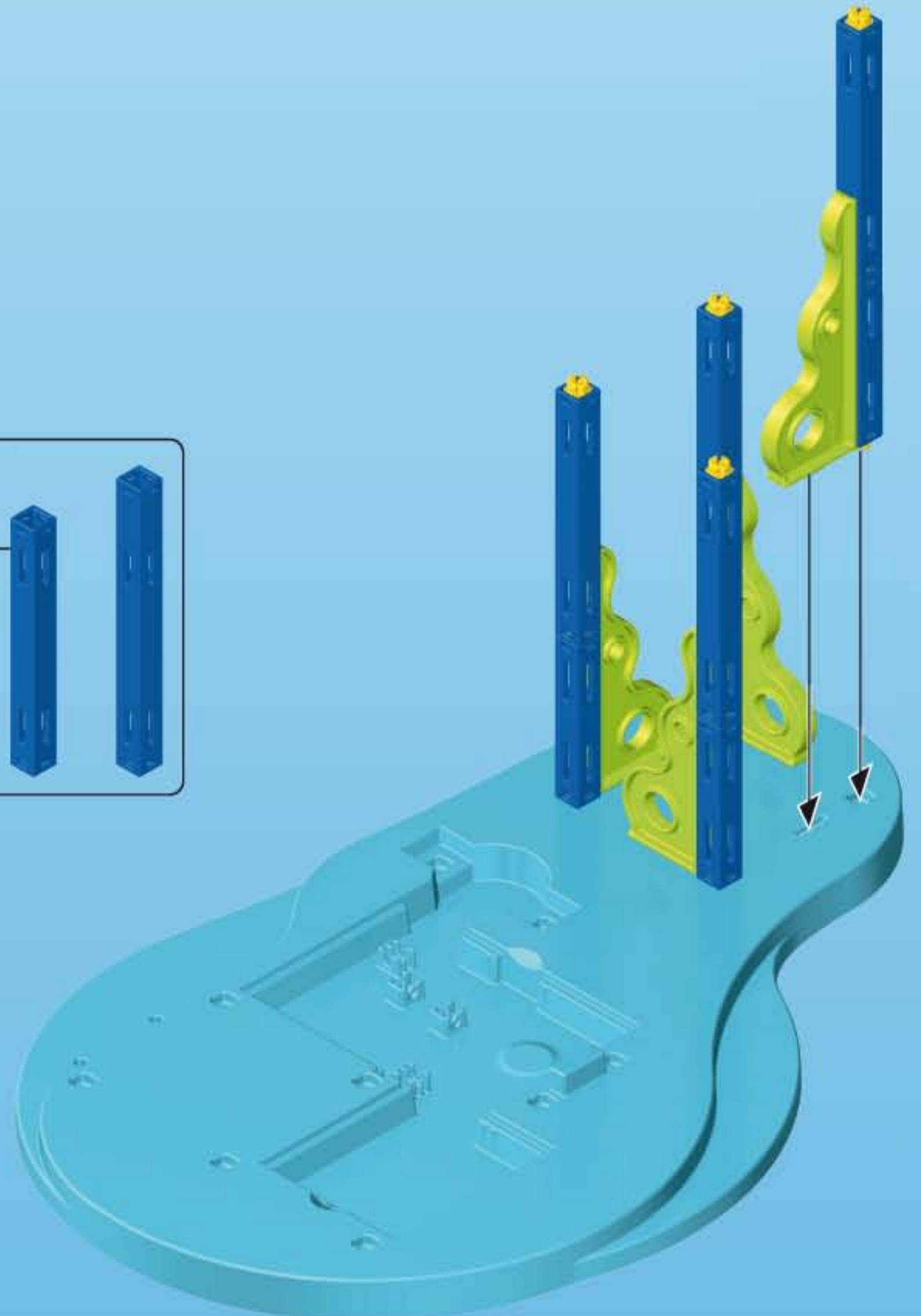
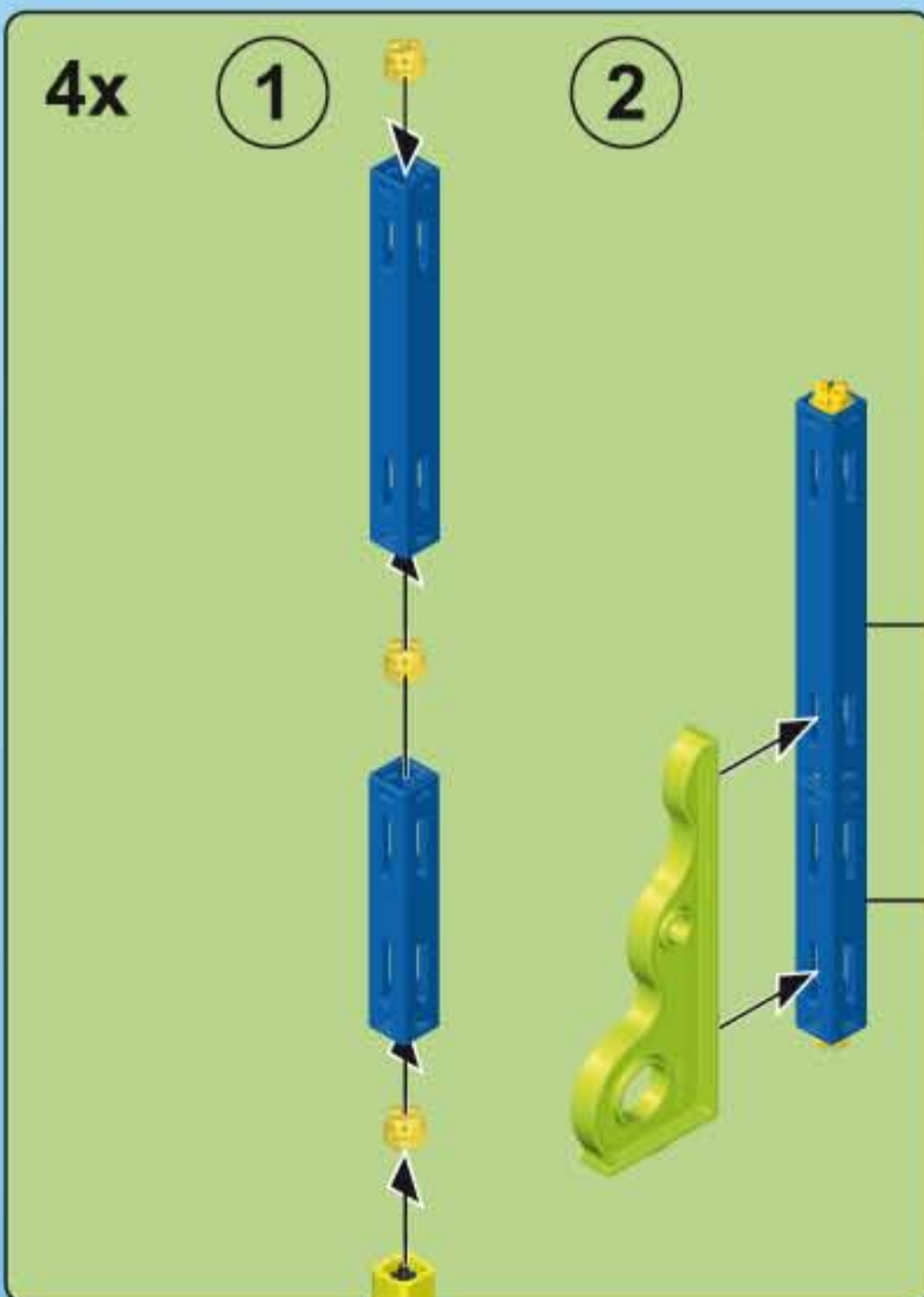

2

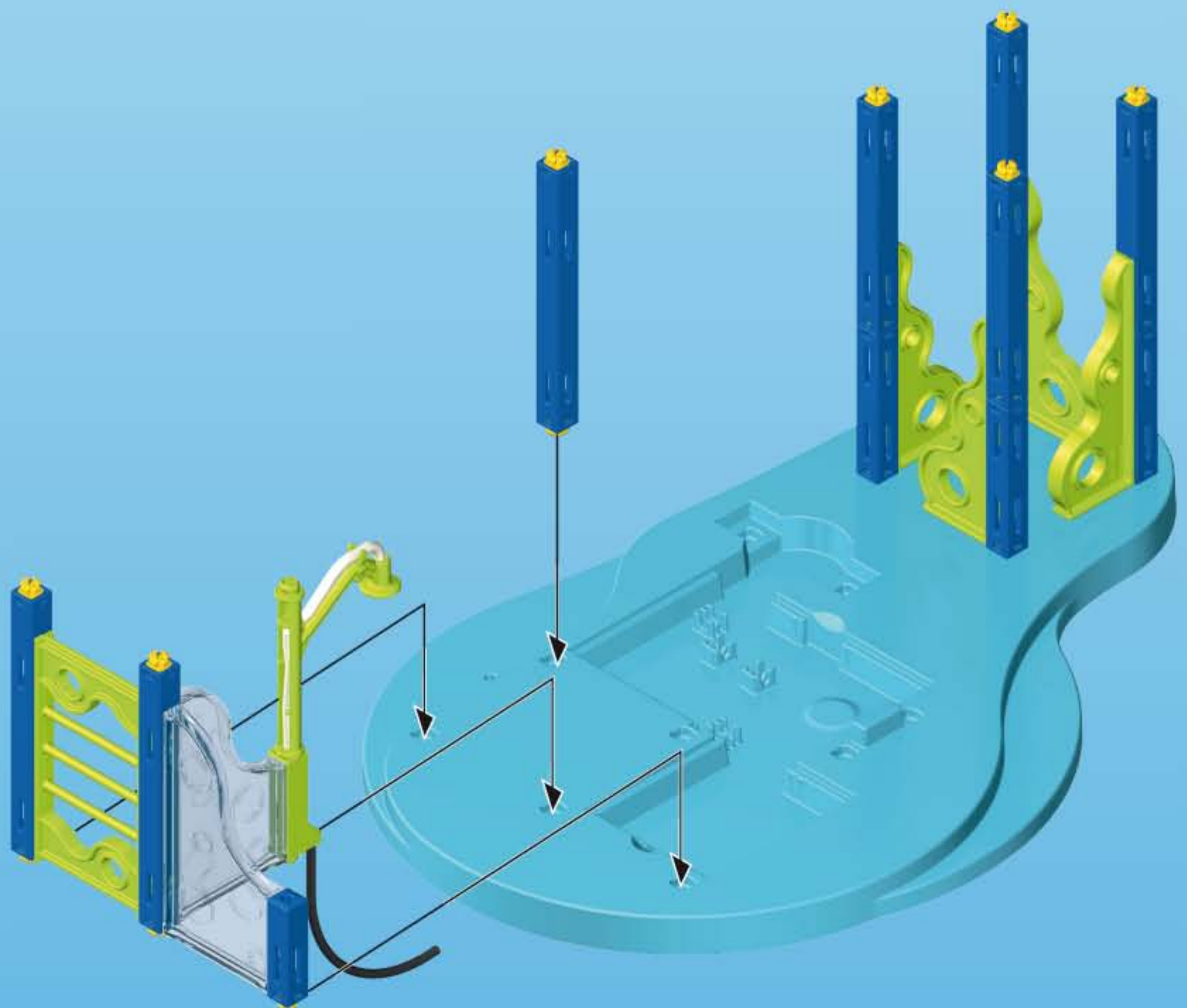
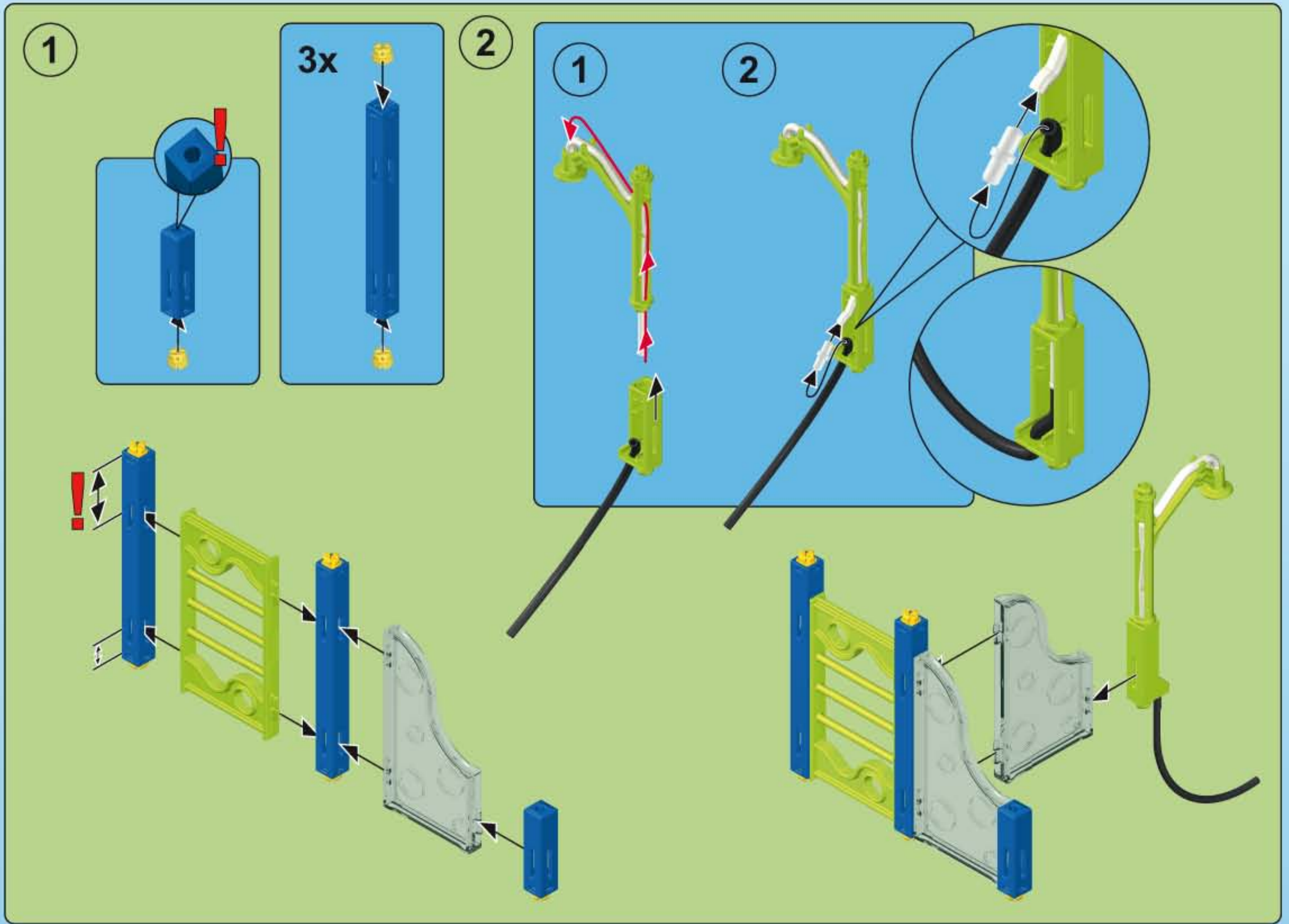

3

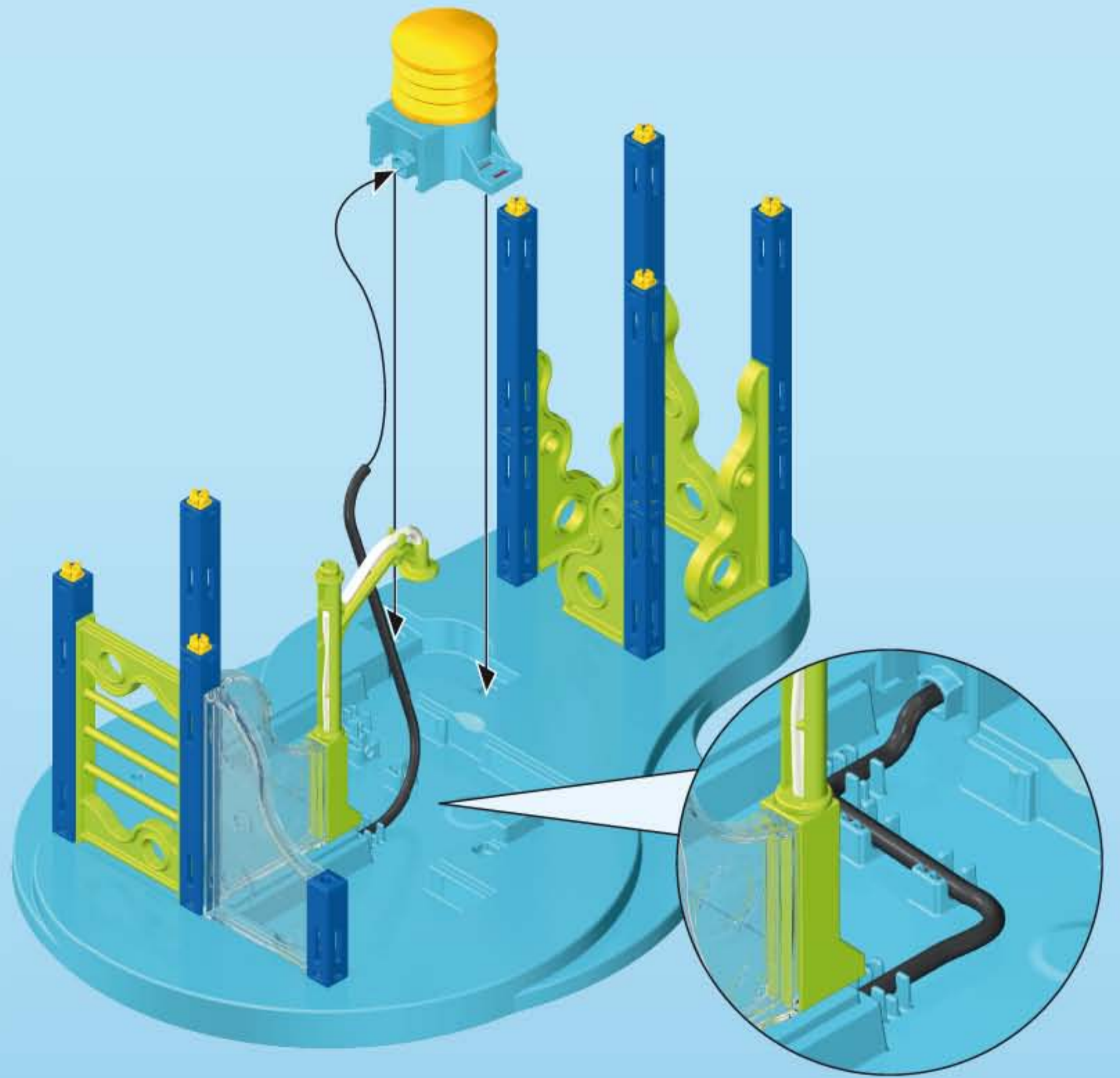
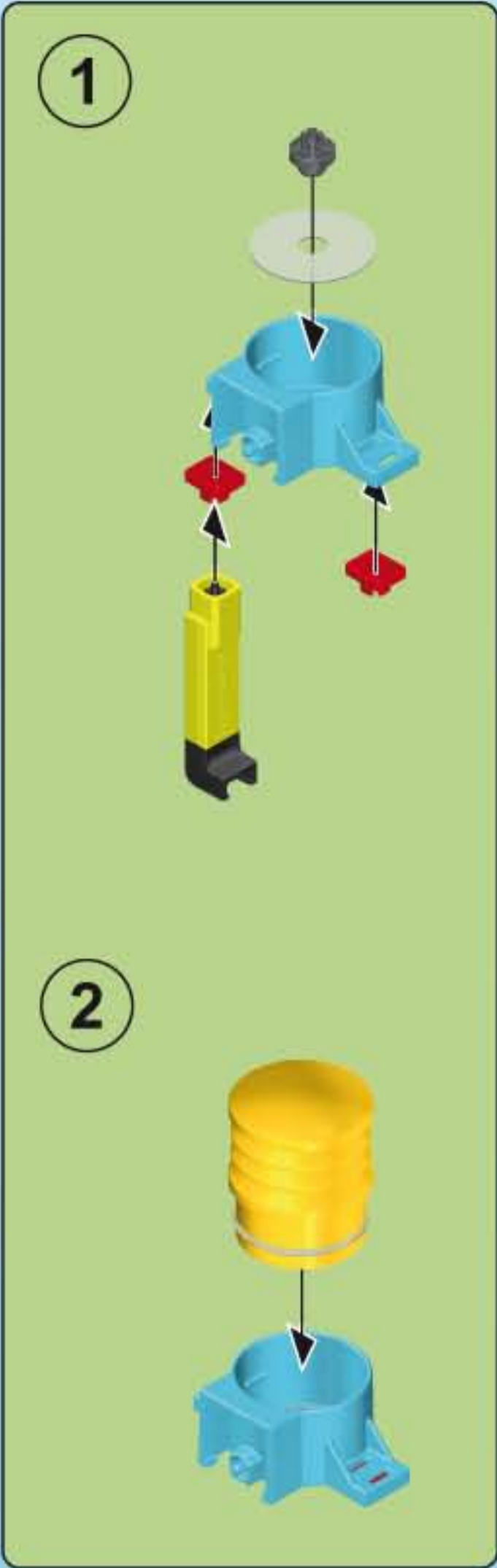

4

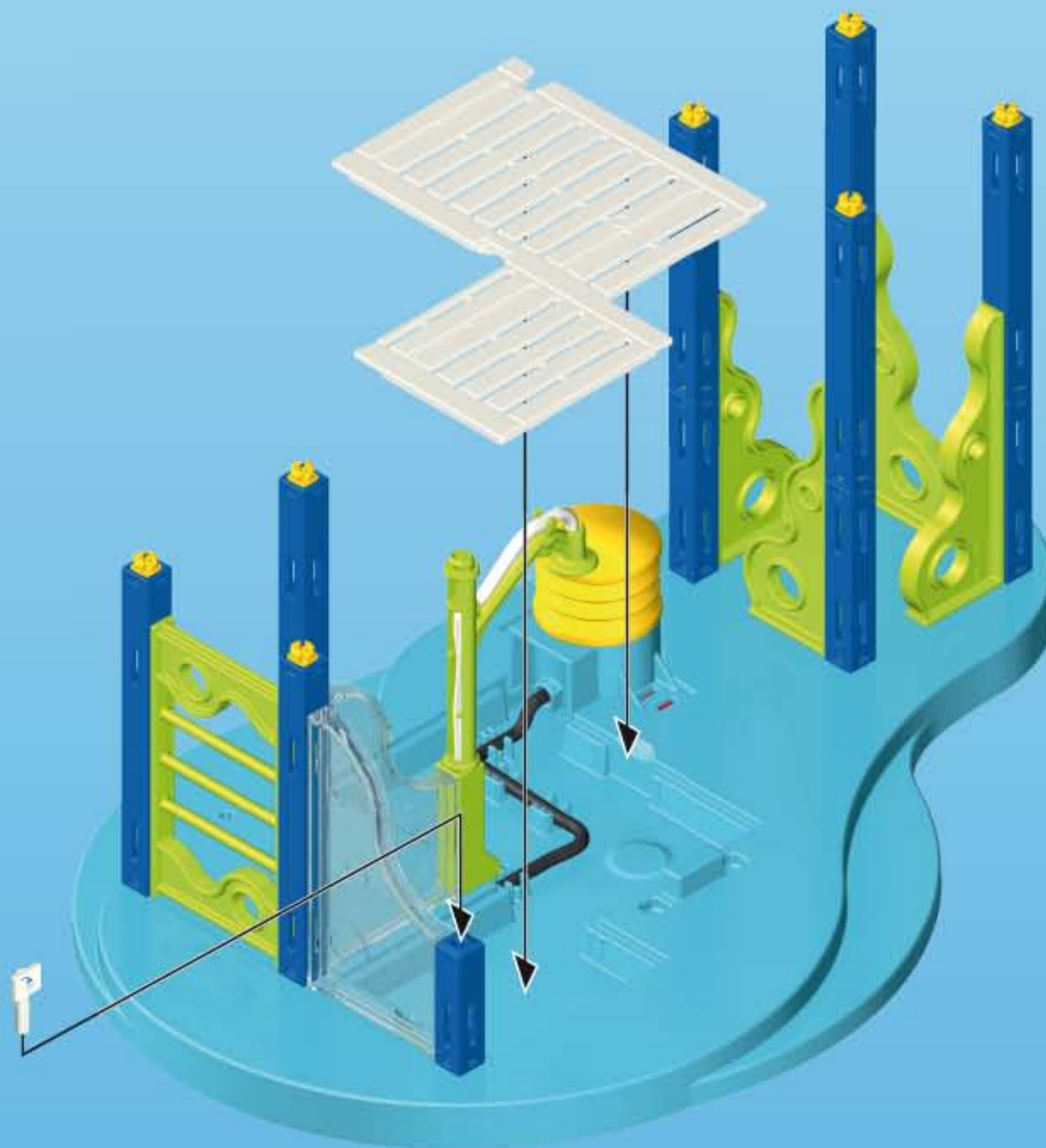

5

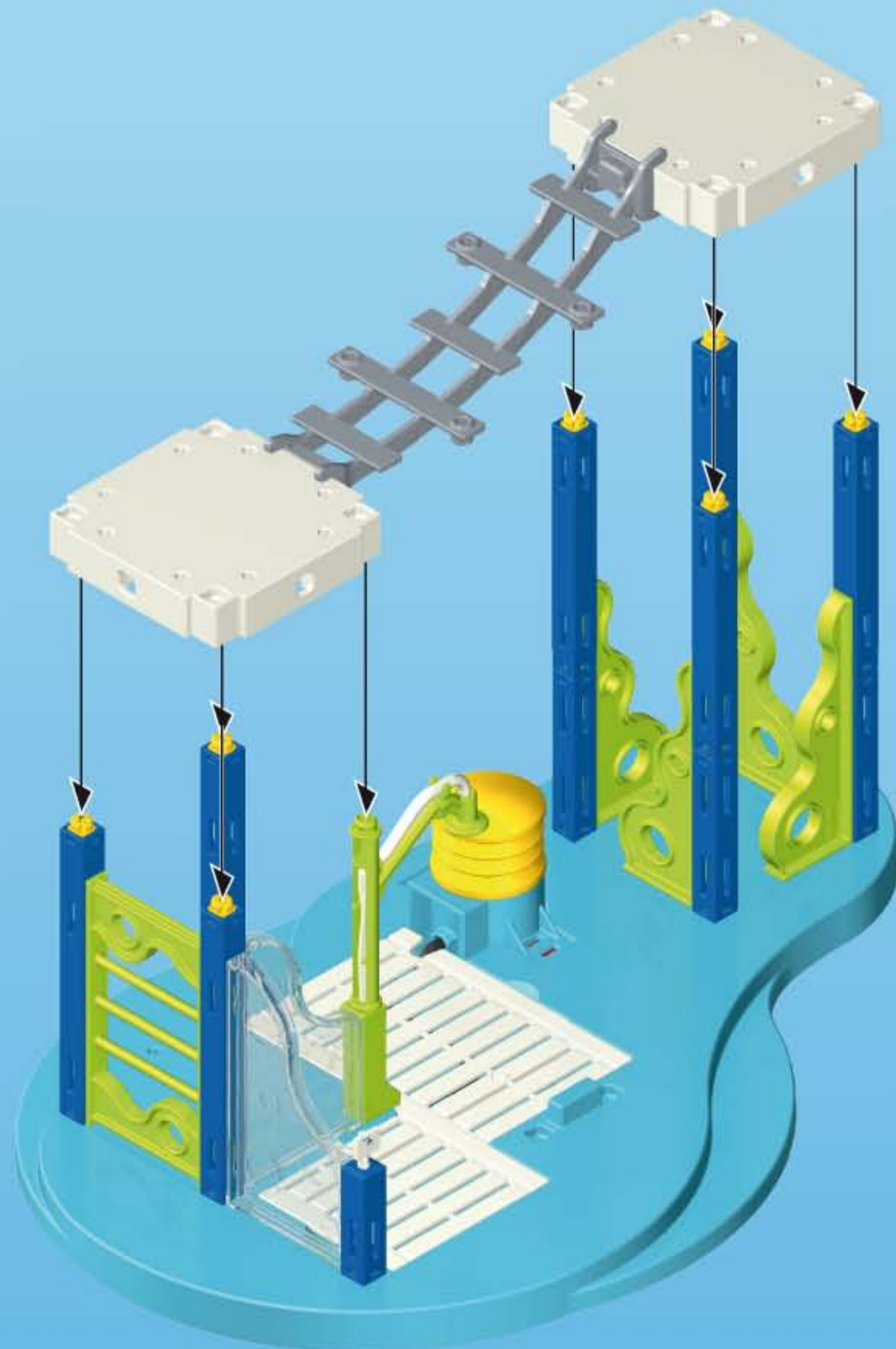
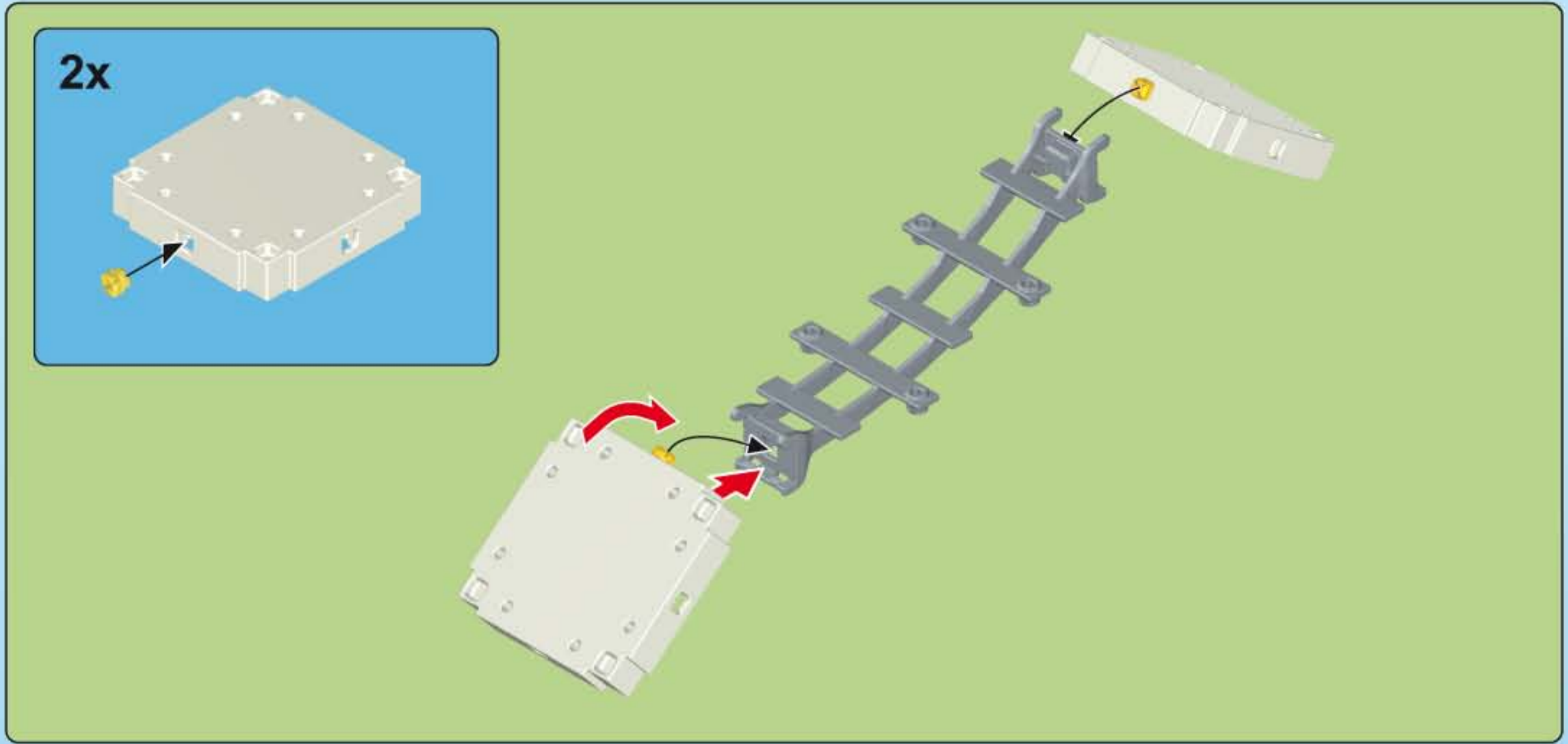

6

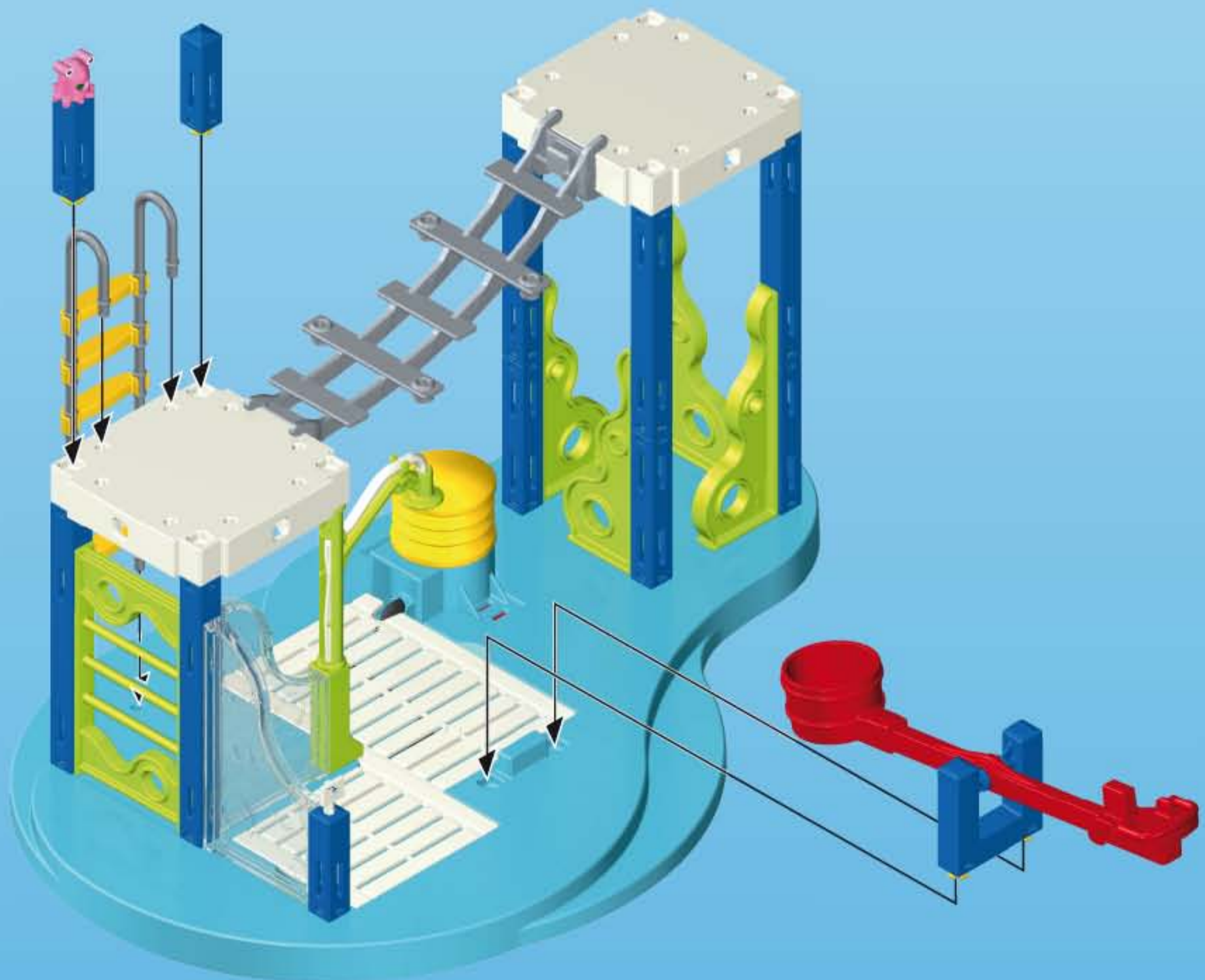
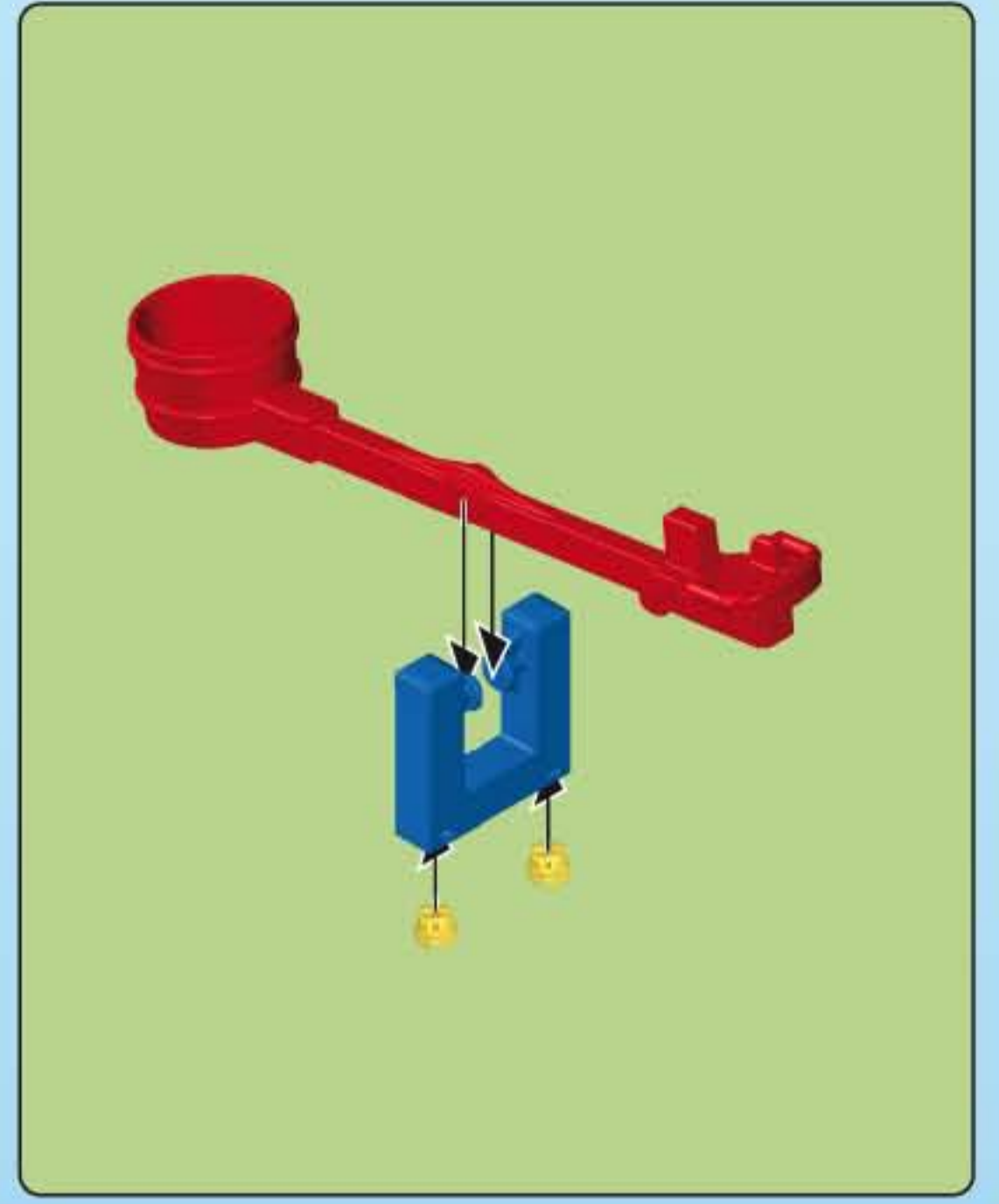
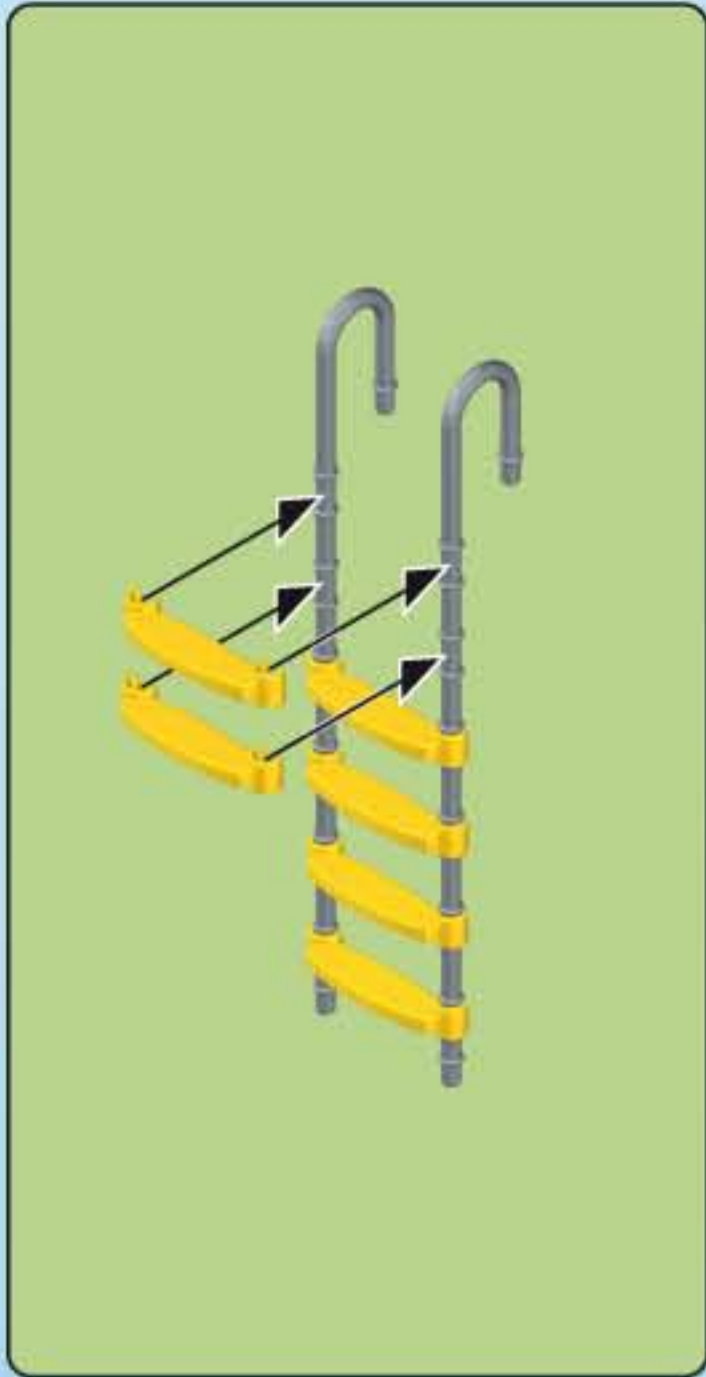
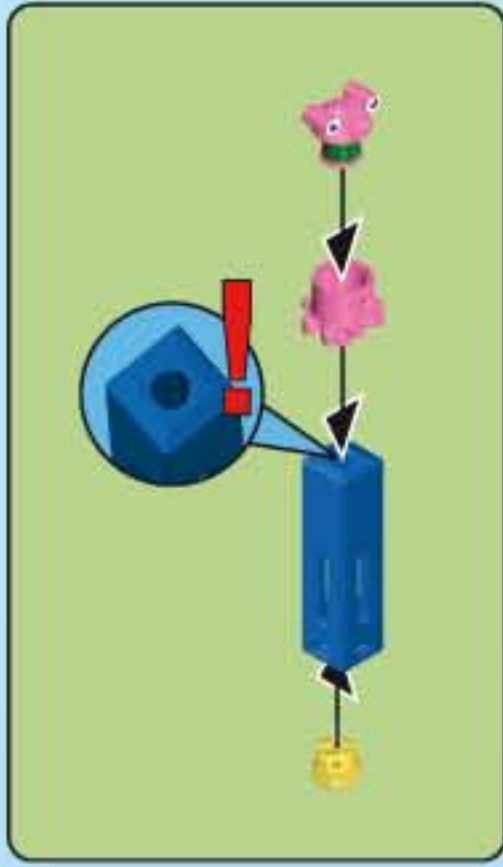

7

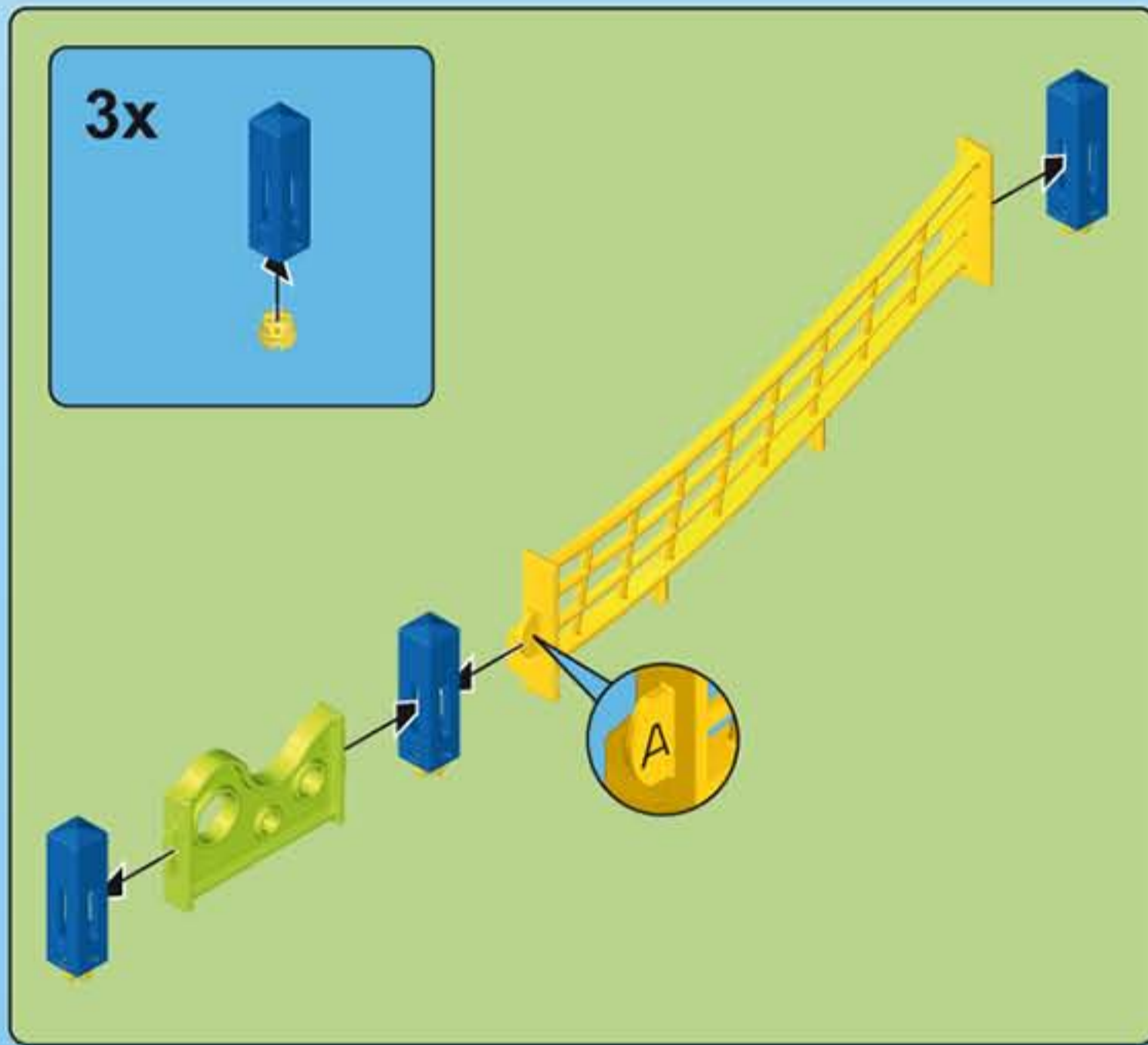
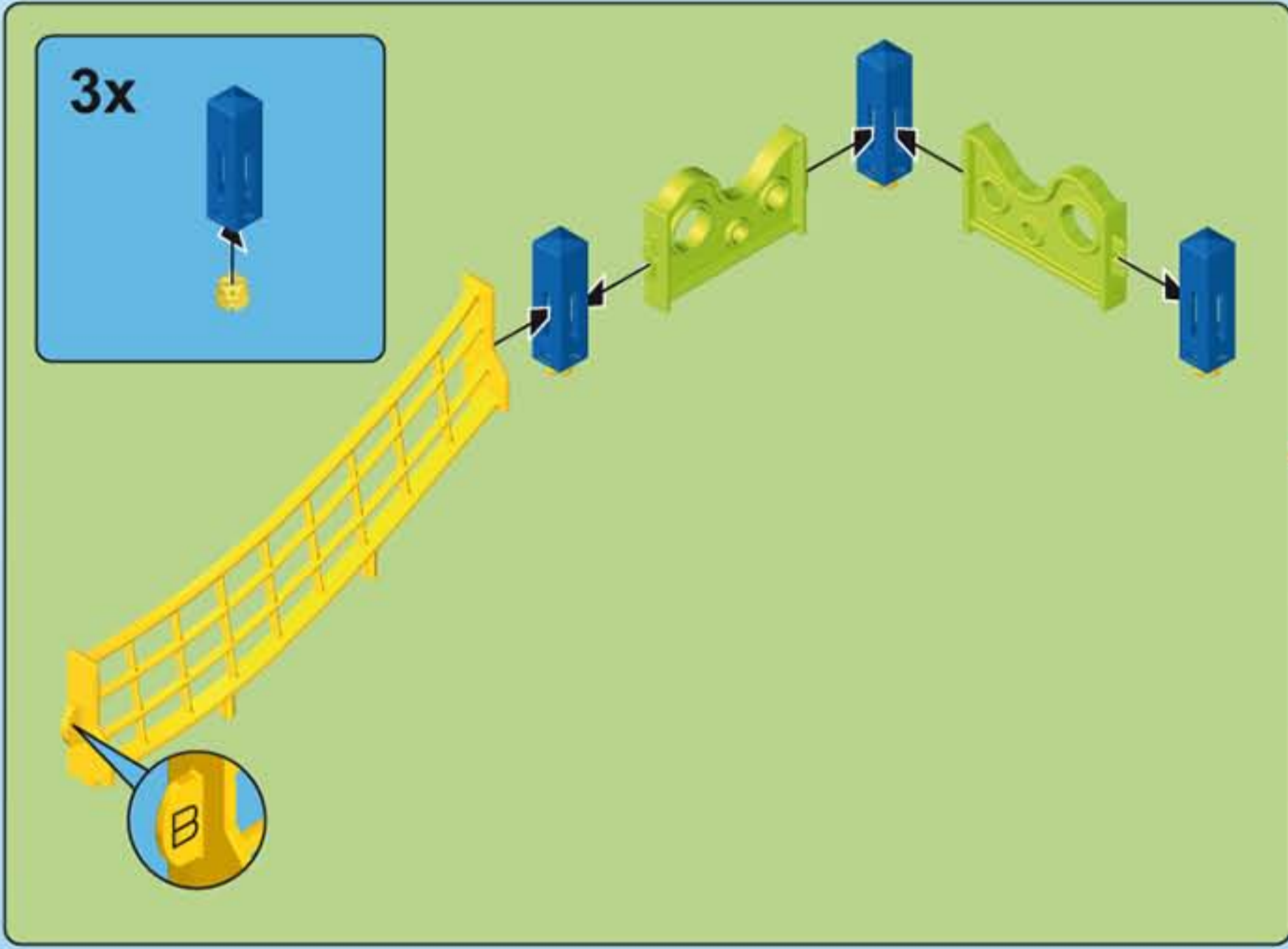

8



9

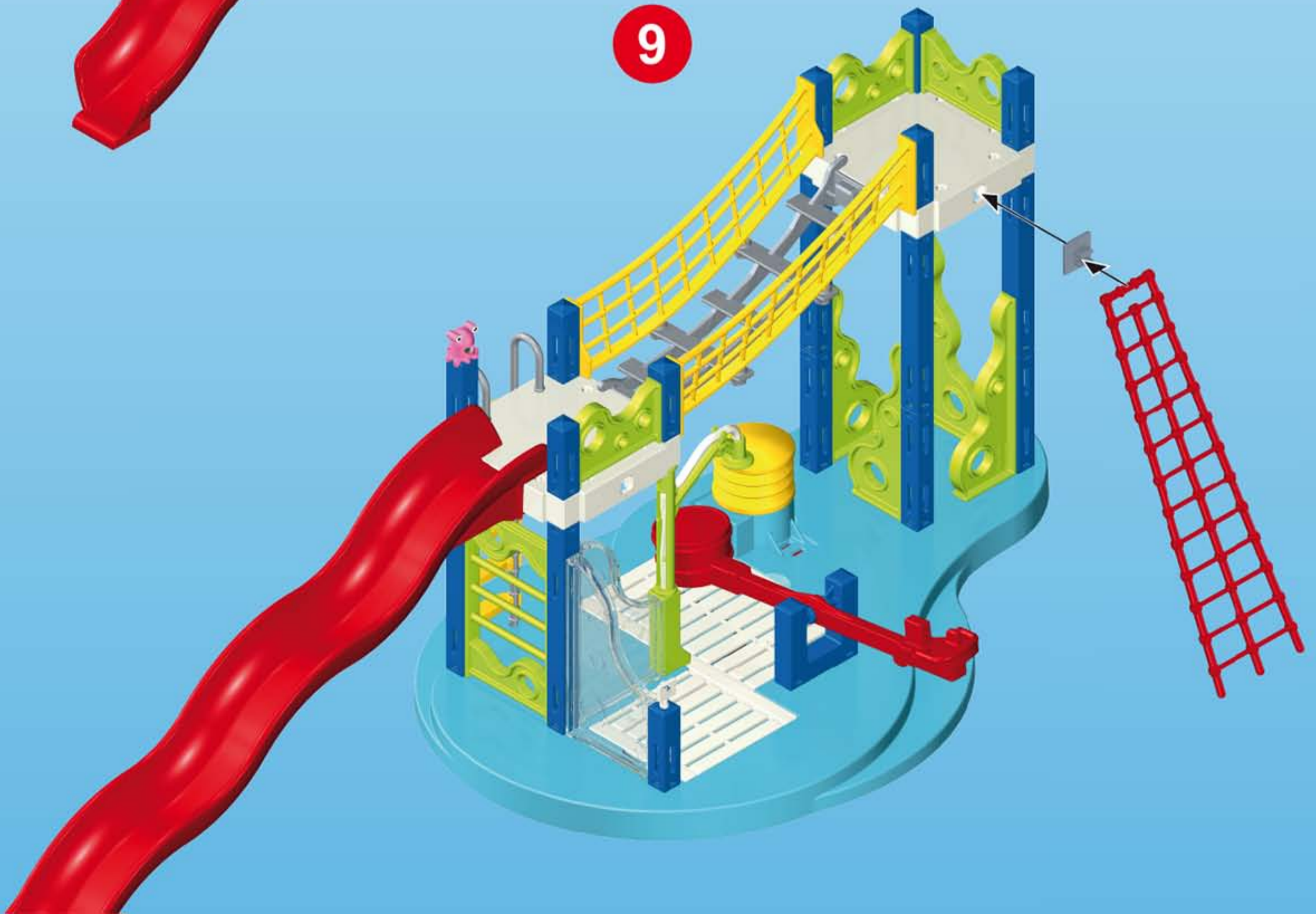

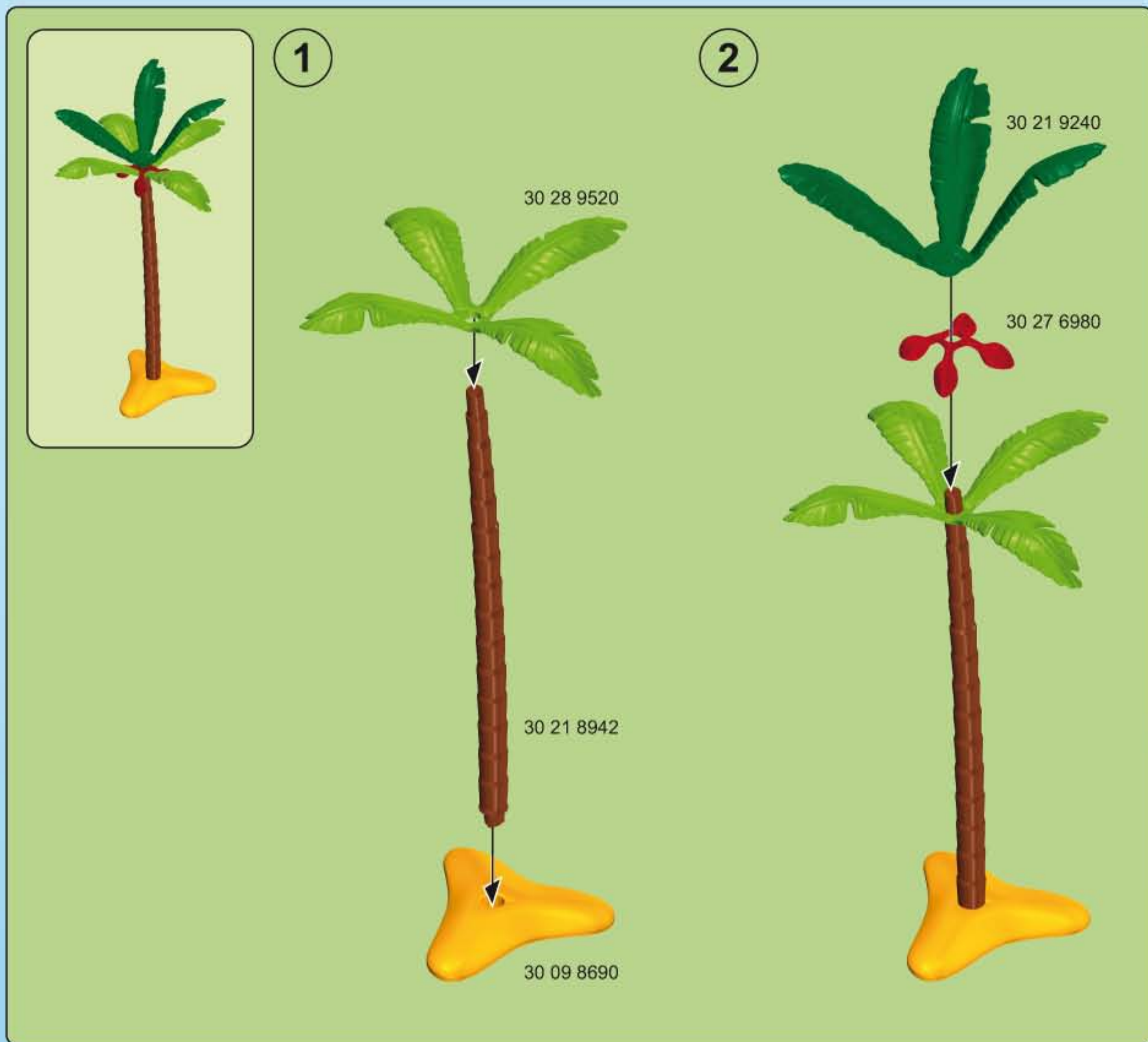

30 21 9663



2x 30 23 5583



30 21 9623



30 21 9613



30 21 9603



30 21 9633



30 23 5463



3x 30 21 9693



4x 30 23 5533



4x 30 23 5543



7x 30 23 5523



2x 30 21 9703



2x 30 21 9593



30 21 9673



6x 30 23 5433

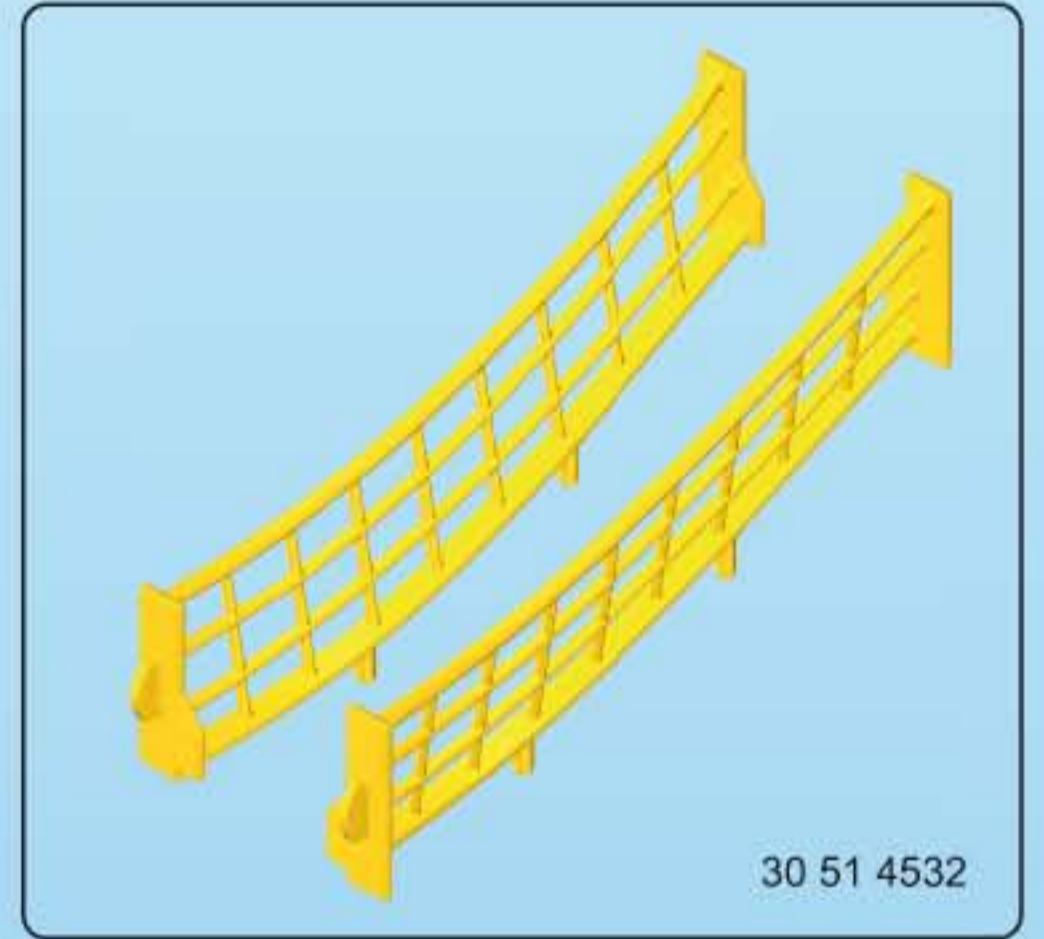

30 51 4532



2x 30 21 9683



30 21 9583



30 89 0962

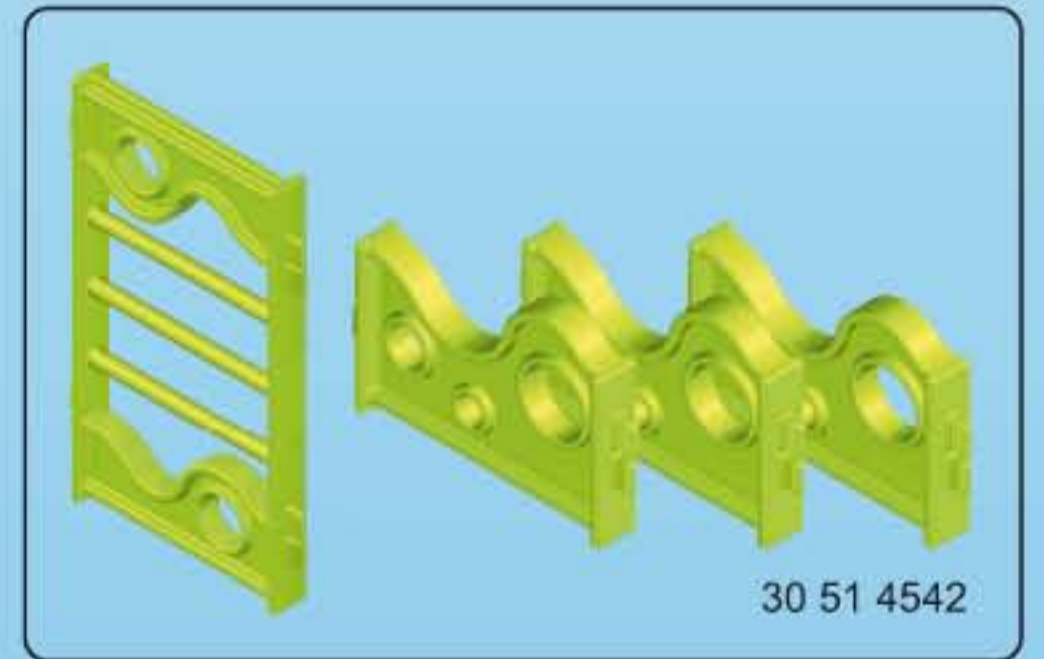

30 51 4542



4x 30 23 5513



30 21 9643



30 21 9653



30 88 8740



30 89 0972



30 25 9003



30 80 6823



30 21 4793

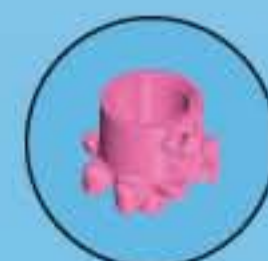

30 23 5343



30 64 0204



30 23 5303



30 28 1950



32x 30 03 6600

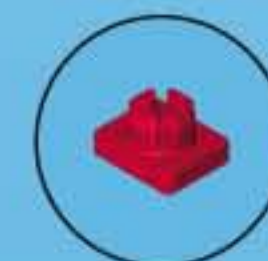

2x 30 09 6900



30 64 0254

6670 + 6669



1

6670

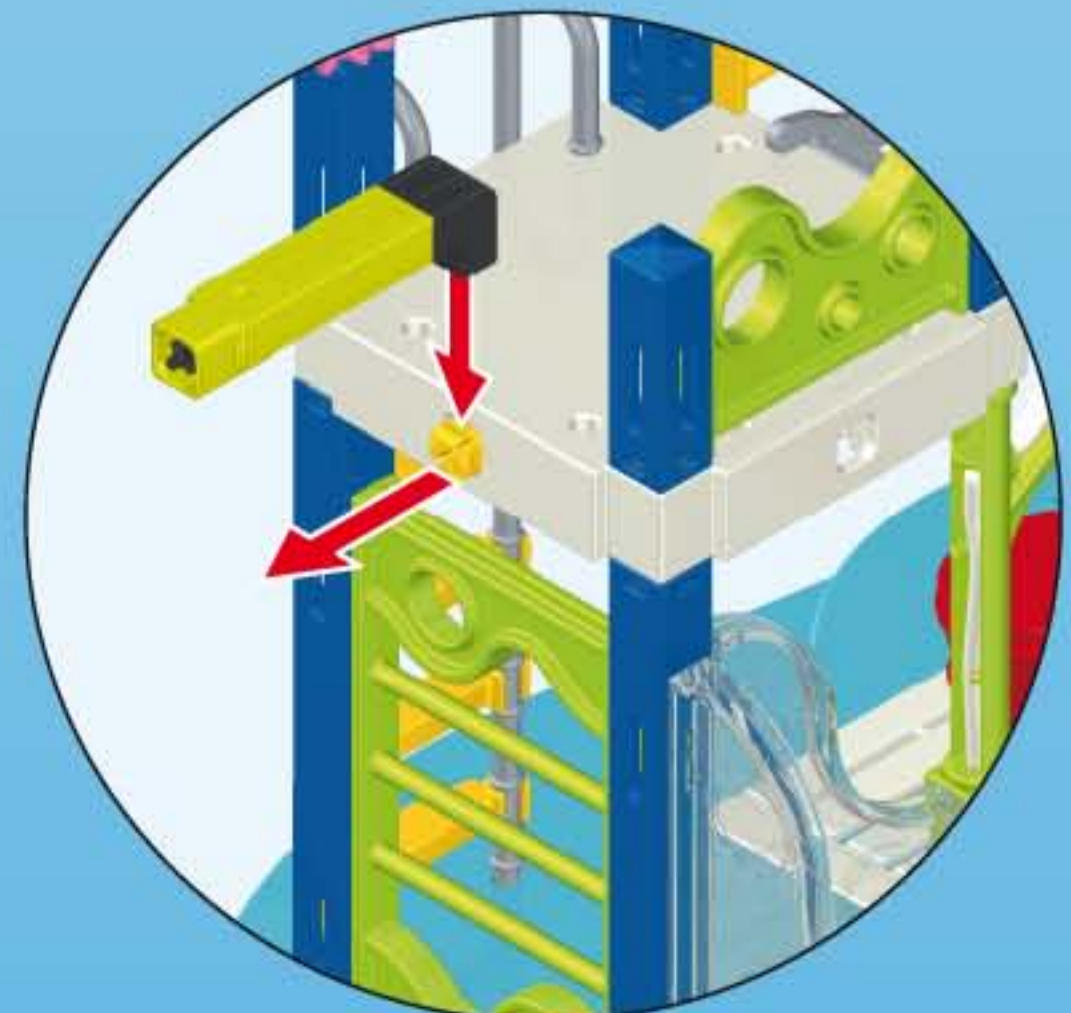
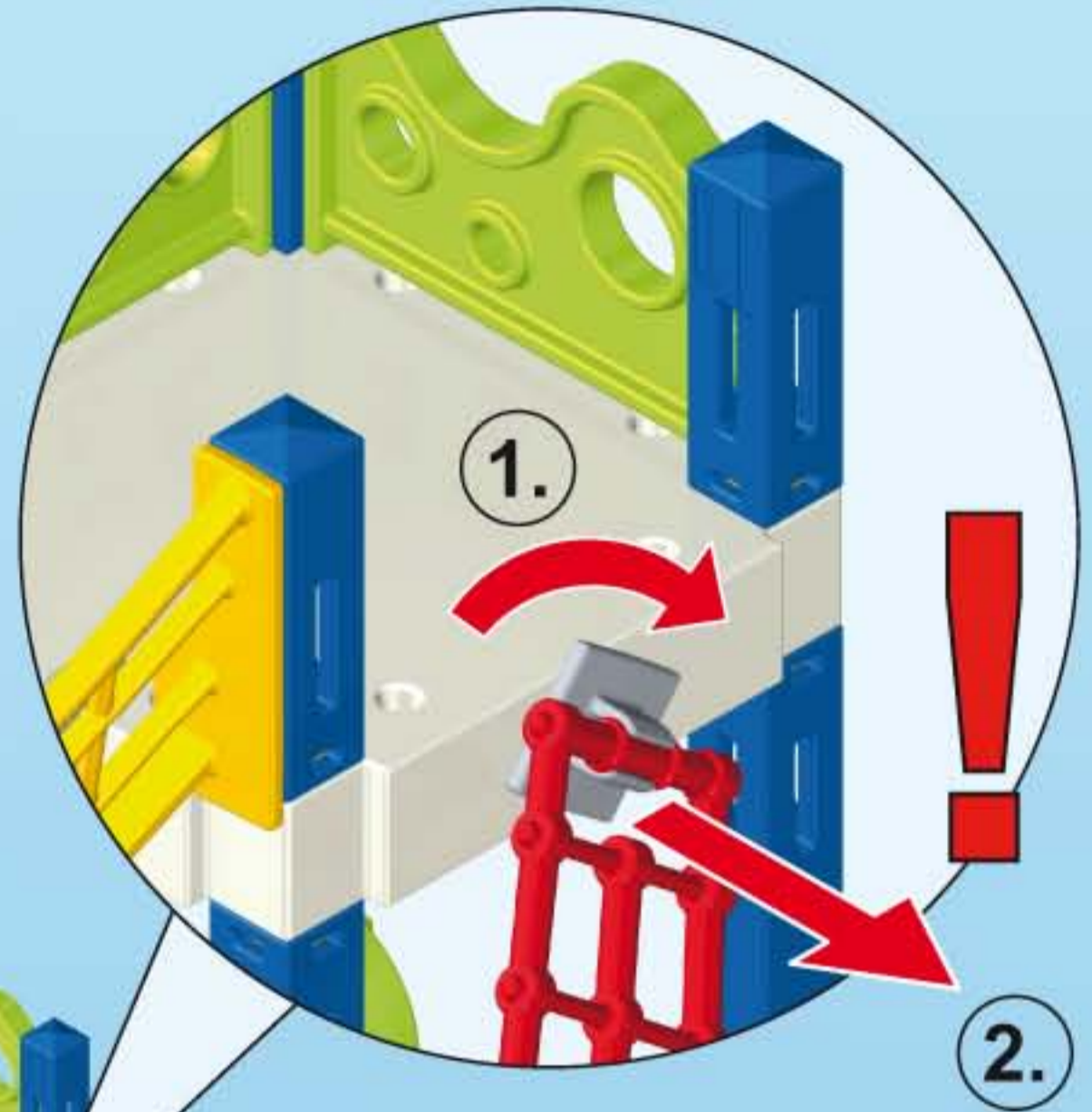

2





(D A CH L B) ACHTUNG! Nicht auf Augen oder Gesicht zielen. Nur Trinkwasser verwenden. Nach dem Spielen austrocknen lassen.

(USA GB CDN M IRL) WARNING! Do not aim at eyes or face. Use only tap water. Dry thoroughly after play.

(F CDN B L CH) ATTENTION! Ne pas viser les yeux ou le visage. N'utiliser que de l'eau potable. Faire sécher après chaque utilisation.

(E MEX) ¡ADVERTENCIA! No apuntar a los ojos ni a la cara. Utilizar solamente agua potable. Dejar secar antes de guardar.

(NL B) WAARSCHUWING! Niet op ogen of gezicht richten. Enkel drinkbaar water gebruiken. Na het spelen laten drogen.

(I CH) AVVERTENZA! Non mirare agli occhi o al viso. Usare solo acqua potabile. Asciugare bene dopo ogni uso.

(P) ATENÇÃO! Não apontar para os olhos ou face. Utilizar somente água potável. Deixar secar antes de guardar.

(DK) ADVARSEL! Sigt ikke mod øjne eller ansigt. Anvend kun drikkevand. Lad det tørre ud når du er færdig med at lege.

(N) ADVARSEL! Sikt ikke på ansikt eller øyne. Kun drikkevann skal benyttes. Tørk opp etter at leken er ferdig.

(S FIN) VARNING! Sikta inte mot ögon eller ansikte. Använd endast dricksvatten. Låt torka efter användandet.

(FIN) VAROITUS! Ei saa kohdistaa suoraan silmiin tai kasvoihin. Käytä ainoastaan juomavettä. Anna kuivua leikin jälkeen.

(H) FIGYELMEZTETÉS. Tilos szemre vagy arcra célozni. Kérjük kizárólag ivóvizet használni! Játék után ajánlott a termék kiszáritása!

(CZ) UPOZORNĚNÍ! Nemiřte na oči nebo na obličej! Používat jen pitnou vodu. Po hraní nechat vyschnout.

(EST) HOIATUS! Ära sihi silmadesse ega näkku. Kasutada üksnes joogivett! Mängimise järel kuivatada!

(LV) BRIDINĀJUMS! Nevērst pret acīm vai seju. Izmantot tikai dzeramo ūdeni. Pēc spēlēšanās ļaut nožūt.

(LT) ĮSPĖJIMAS! Netaikyti į akis arba veidą. Naudokite tik geriamąjį vandenį. Pažaidus, išdžiovinkite.

(SLO) OPOZORILO! Ne merite v oči ali obraz. V igračo vlivajte le pitno vodo. Po igri naj se igrača posuši.

(SK) UPOZORNENIE! Nemieriť do očí alebo do tváre. Používať iba pitnú vodu. Po hre nechať vyschnúť.

(PL) OSTRZEŻENIE! Nie celować w oczy i twarz. Używać tylko wodę pitną. Po zabawie pozostaw do wyschnięcia.

(TR CY) DİKKAT! Göze veya yüze doğru tutmayınız. Sadece içme suyu kullanınız. Oyundan sonra kurumaya bırakın.

(GR CY) Προειδοποίηση! Μη μην γίνεται στόχευση στα μάτια ή στο πρόσωπο. Χρησιμοποιείστε μόνο νερό βρύσης. Μόλις τελειώσετε, αφήστε το παιχνίδι να στεγνώσει εντελώς.

(RO) AVERTISMENT! Nu se țintește în ochi sau în față. Se folosește doar apă potabilă. După joacă se lasă să se usuce.

(BG) Внимание! Не насочвайте към очите и лицето. Използвайте само питейна вода. След игра оставете да изсъхне.

(HR) UPOZORENJE! Ne ciljati u oči ili lice. Koristiti samo pitku vodu. Poslije igranja pustiti da se osuši.

(CN) 警告! 请勿瞄准眼睛或脸。仅使用饮用水。玩耍后要干燥。

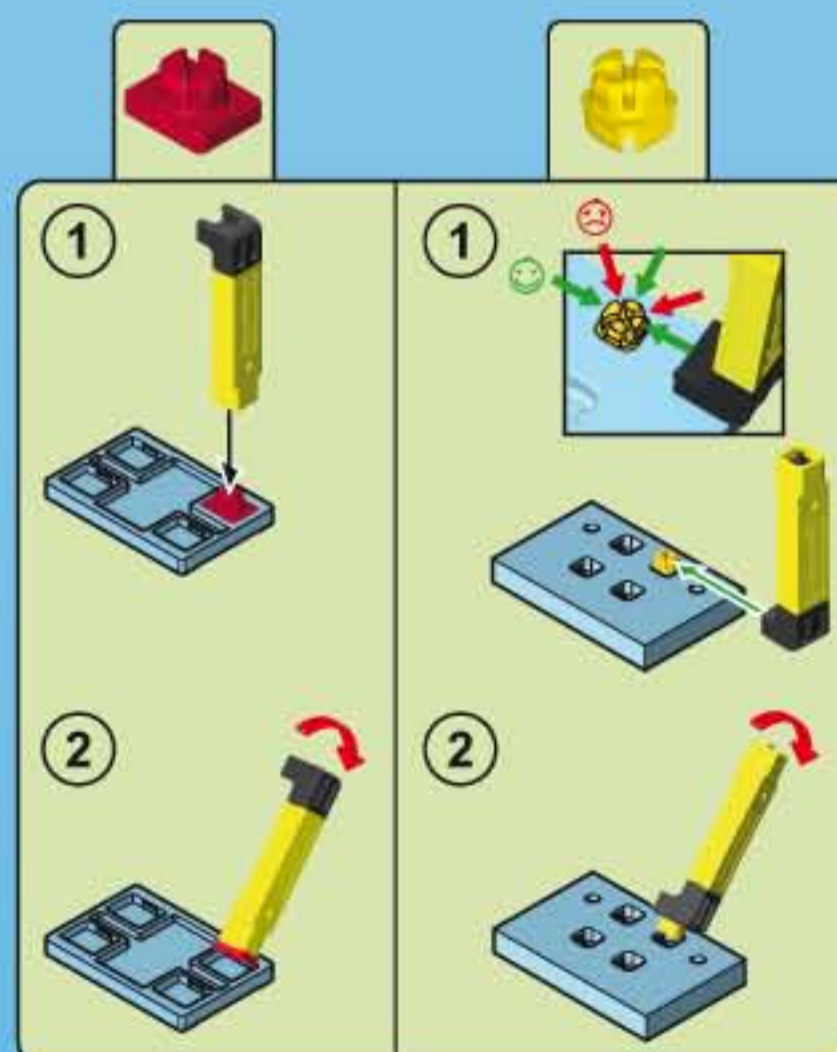

Serviceadressen finden Sie in allen Playmobil-Prospekten

Addresses of Customer Service Departments are shown in all Playmobil catalogues

L'adresse du service consommateurs est indiquée dans tous les catalogues Playmobil

Troverete gli indirizzi dei centri di assistenza in tutti i cataloghi Playmobil

In alle PLAYMOBIL cataloghi vintu u het adres van onze klantendienst.

Las Direcciones de los Departamentos de Servicio al Consumidor se encuentran en todos los catálogos Playmobil

Η διεύθυνση του Γραφείου Εξυπηρέτησης Καταναλωτών PLAYMOBIL βρίσκεται σε όλους τους καταλόγους PLAYMOBIL.

pronounce: plāy-mō-bēil