

playmobil®

5130

Wichtige Unterlagen, bitte sorgfältig aufbewahren!
Important: Please keep these instructions for future reference!
Documents importants, à conserver soigneusement!
Belangrijke documenten, bewaar deze zorgvuldig!

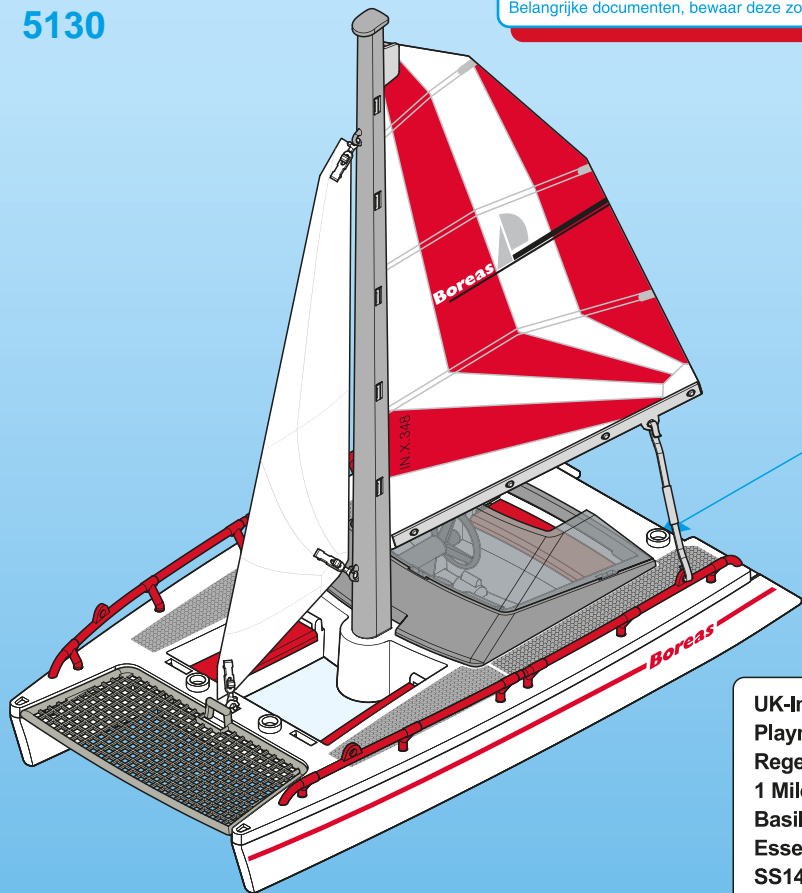

WARNING: CHOKING HAZARD

Small parts. Not for children under 3 years.

"Ne concerne que les USA"

7350

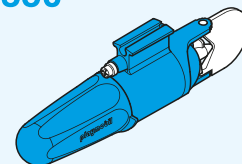

- Nachrüstbar mit Unterwassermotor
- Compatible with the underwater motor (sold separately)
- Monteur submersible, vendu séparément, s'adapte sur ce bateau

Serviceadressen finden Sie in allen PLAYMOBIL-Prospekten

Addresses of Customer Service Departments are shown in all PLAYMOBIL catalogues

L'adresse du service consommateurs est indiquée dans tous les catalogues PLAYMOBIL

Troverete gli indirizzi dei centri di assistenza in tutti i cataloghi PLAYMOBIL

In alle PLAYMOBIL catalogi vindt u het adres van onze klantendienst.

Las Direcciones de los Departamentos de Servicio al Consumidor se encuentran en todos los catálogos PLAYMOBIL

Η διεύθυνση του Γραφείου Εξυπηρέτησης Καταναλωτών PLAYMOBIL βρίσκεται σε όλους τους καταλόγους PLAYMOBIL.

pronounced: plāy-mō-bēil

UK-Importer:
Playmobil UK Ltd.
Regency House
1 Miles Gray Road
Basildon
Essex
SS14 3RW
UK

**UK
CA**

1

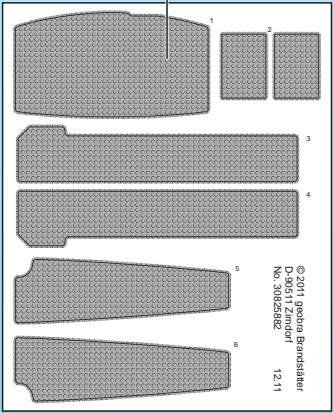

30 82 5882

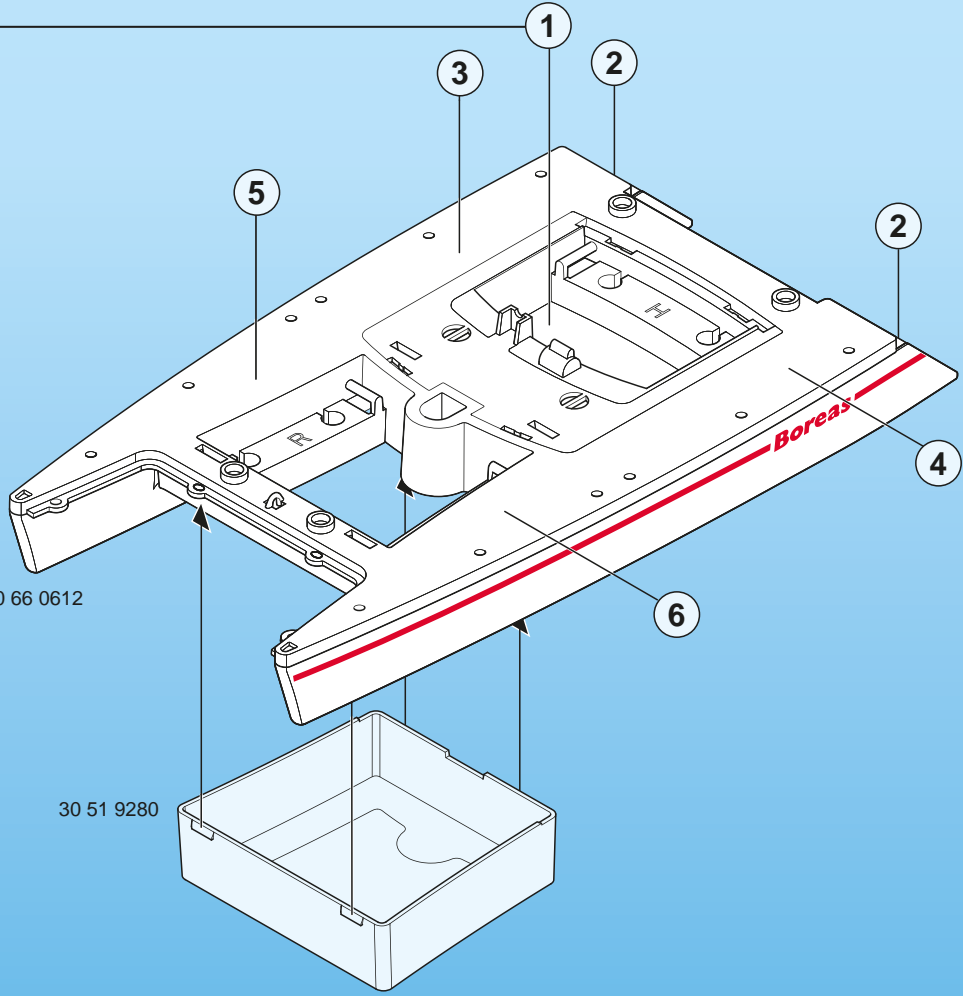

2

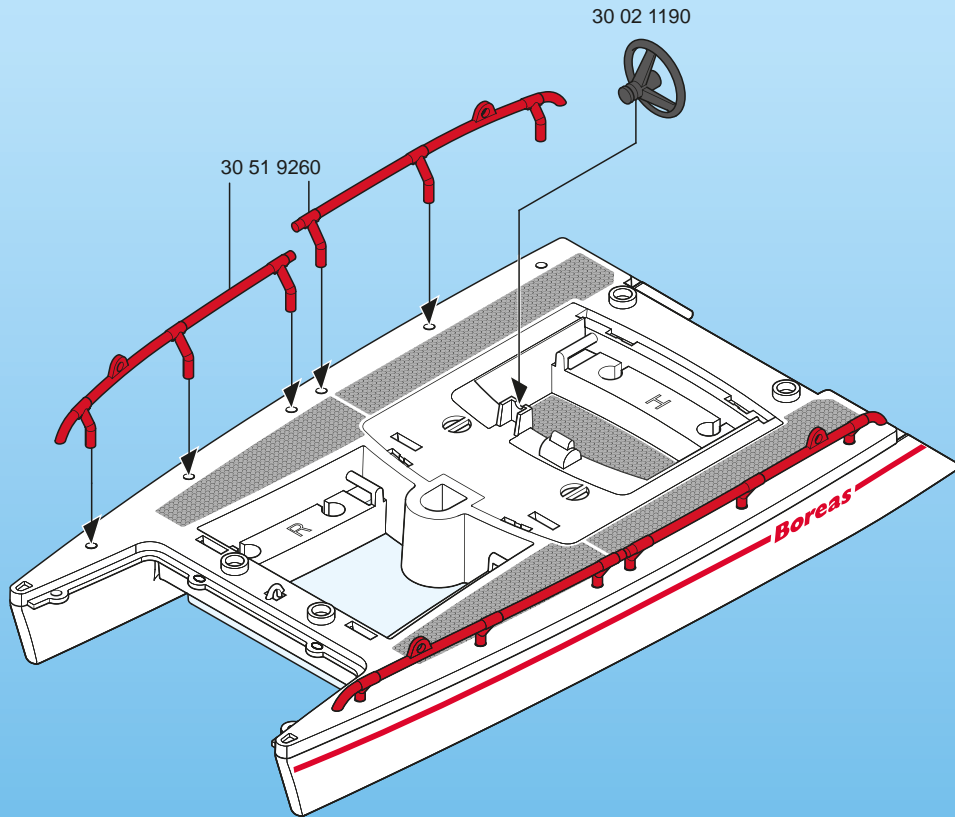

3

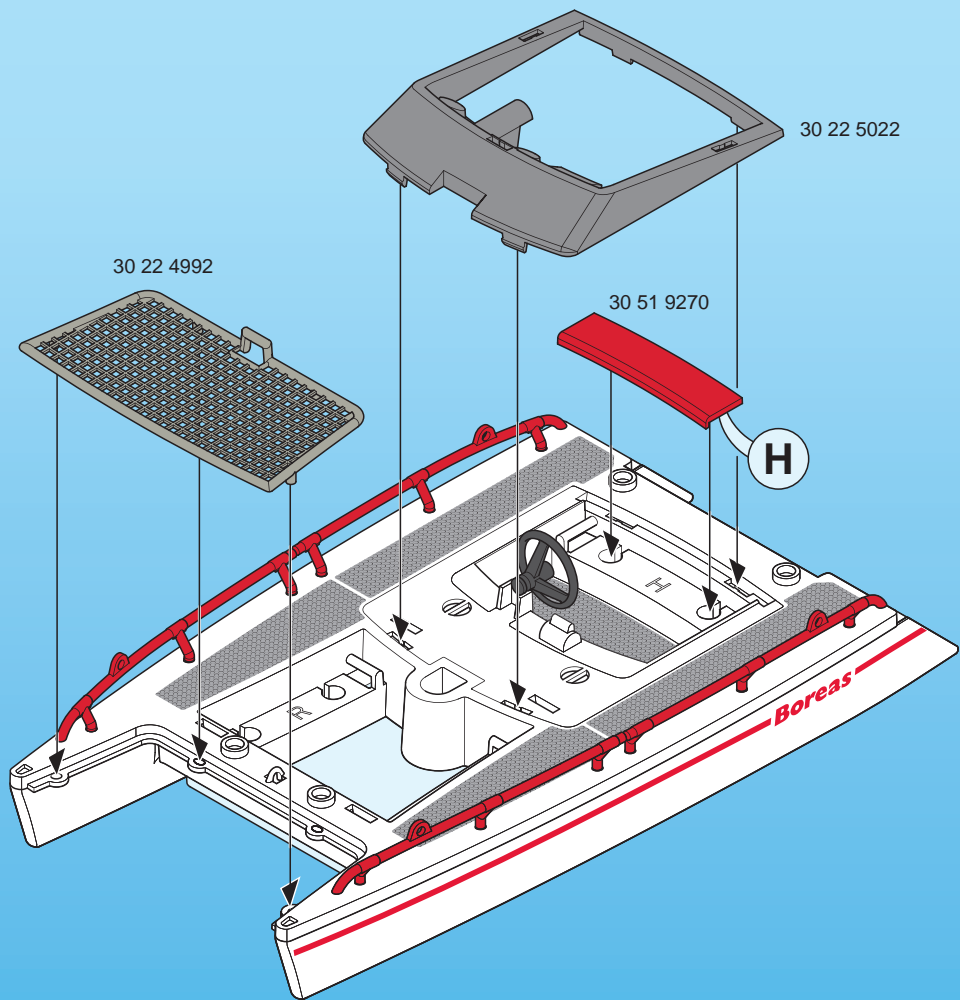

4

4

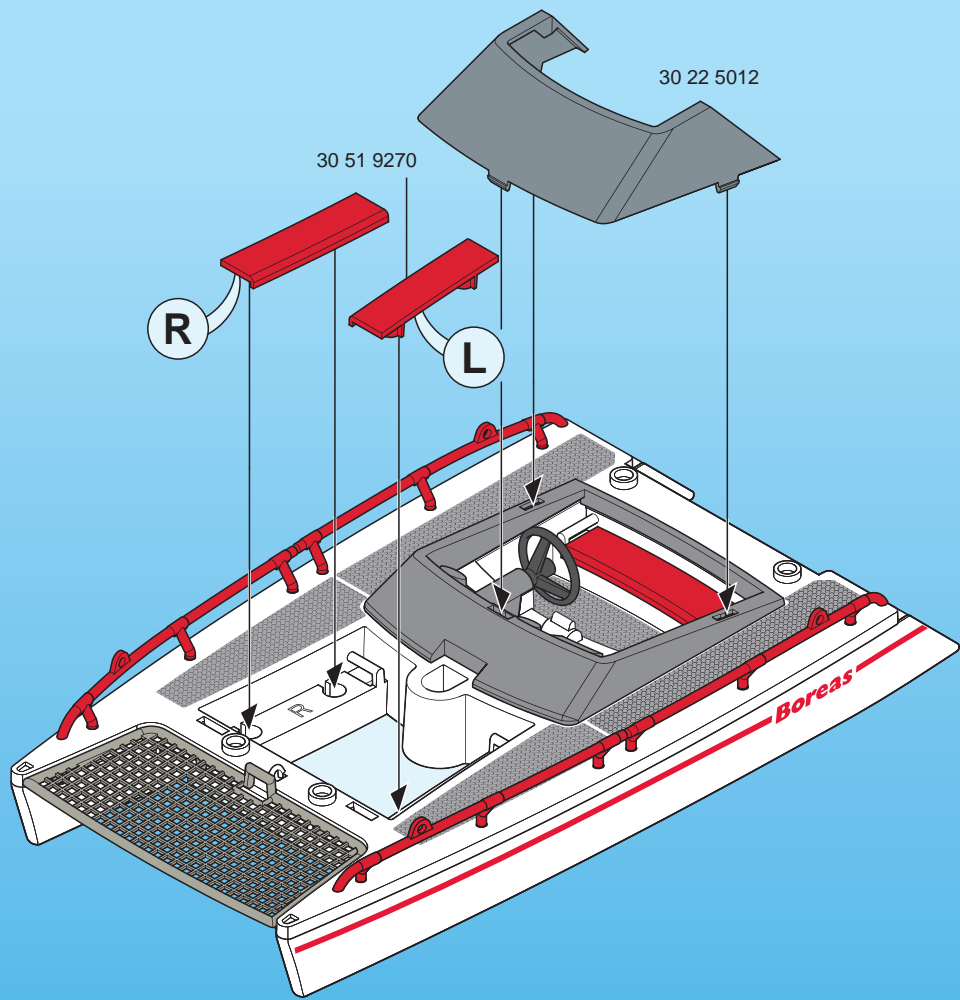

1

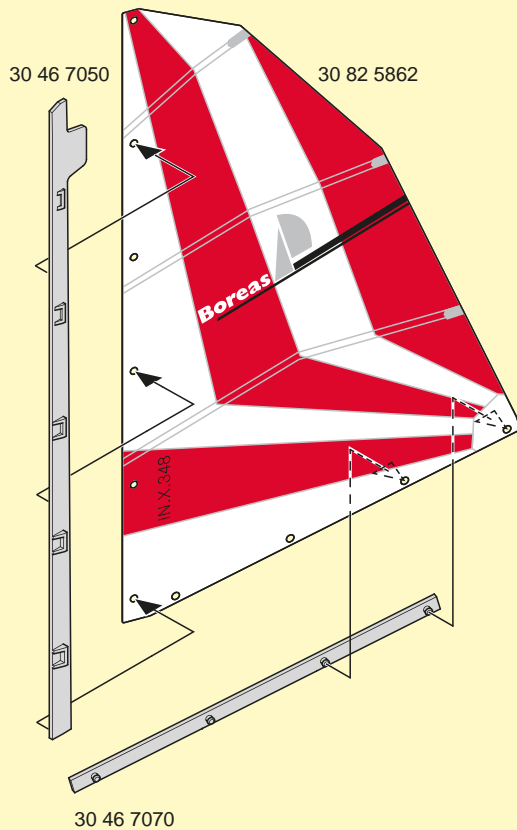

2

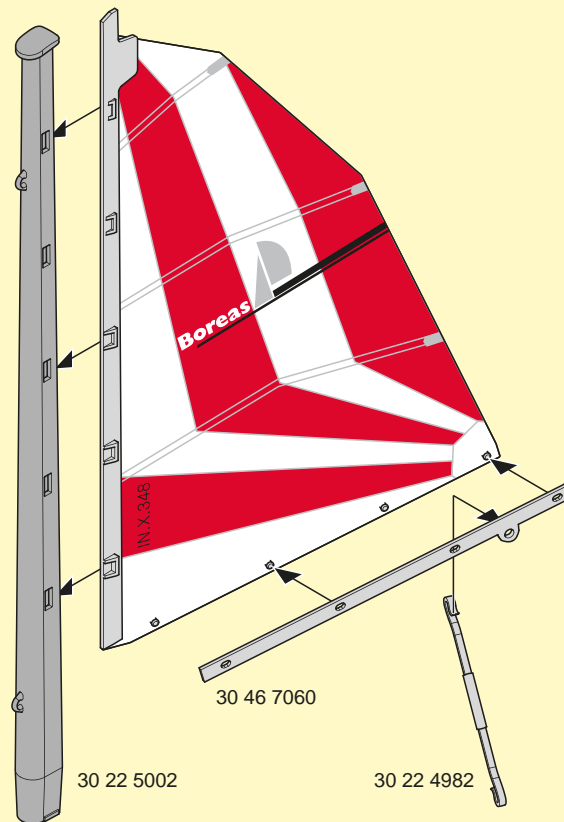

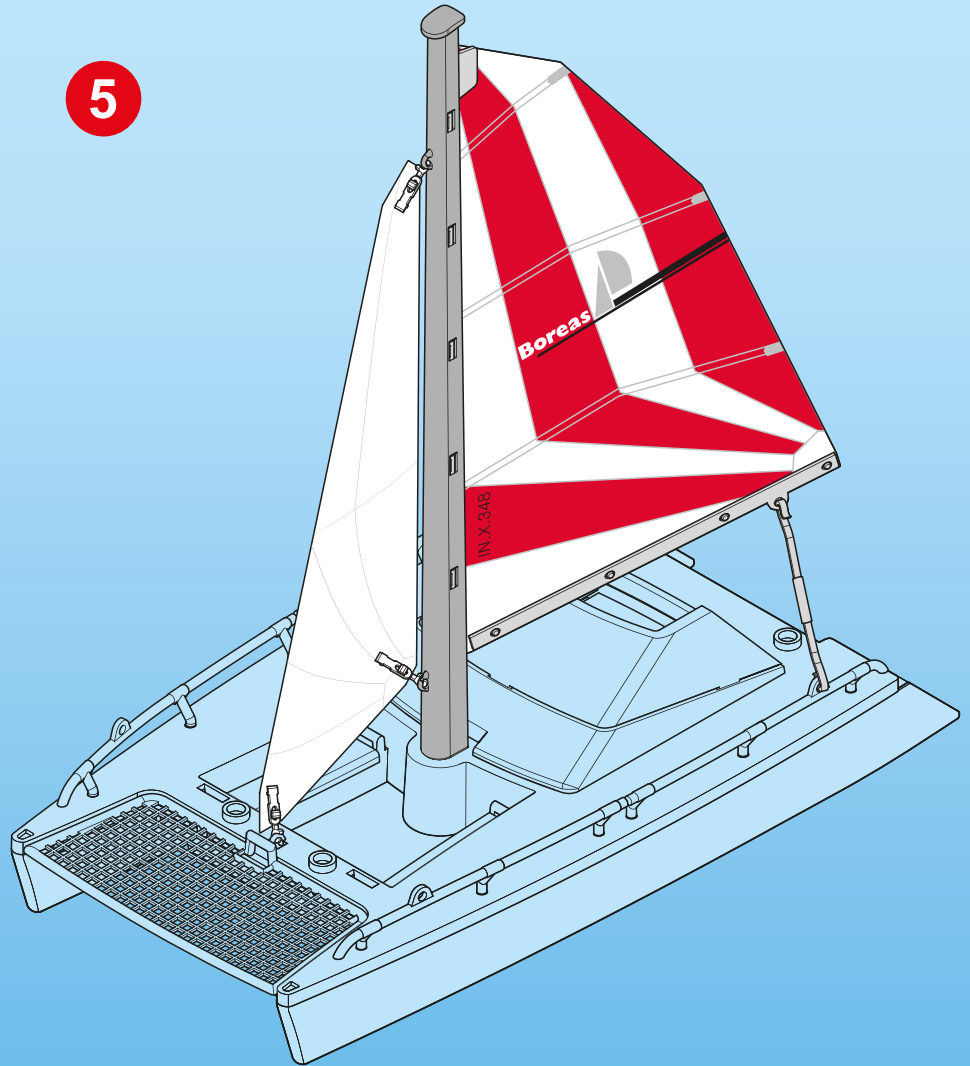
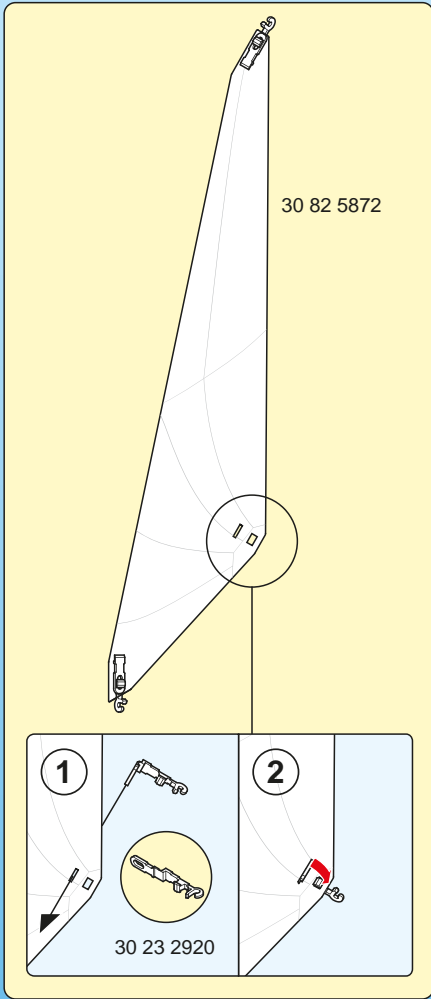

1

30 23 3110

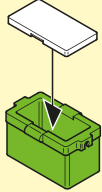

30 23 3140

2

30 21 6140

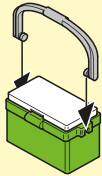

2x

30 21 4663



30 22 1583



30 04 4720



30 00 9092

30 27 4270



30 14 5050

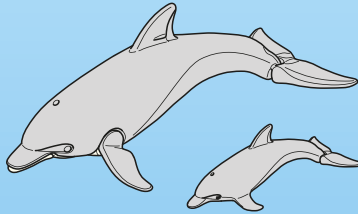

30 66 6010

30 65 3012



30 20 9472



30 06 7780



30 23 1320



30 23 1330



30 89 1920

(DE AT CH LU BE) ACHTUNG!

Nur im flachen Wasser unter Aufsicht von Erwachsenen verwenden.

(US GB CA MT IE) WARNING! Only to be used in water in which the child is within its depth and under adult supervision.**(FR CA BE LU CH) ATTENTION!**

À n'utiliser qu'en eau où l'enfant a pied et sous la surveillance d'un adulte.

(ES MX) ¡ADVERTENCIA!

Utilizar sólo en agua donde el niño pueda permanecer de pie y bajo vigilancia de un adulto.

(NL BE) WAARSCHUWING!

Gebruiken in water waar kinderen kunnen staan en onder toezicht van volwassenen.

(IT CH) AVVERTENZA!

Da utilizzare unicamente in acqua dove il bambino tocca il fondo con i piedi e sotto la eglianza di un adulto.

(PT) ATENÇÃO!

Só utilizar em água onde a criança tenha pé e sob vigilância de adultos.

(DK) ADVARSEL!

Må kun anvendes under opsyn af en voksen og på vanddybder, hvor barnet kan bunde.

(NO) ADVARSEL!

Skal kun brukes i vann som ikke er for dypt for barnet, og der barnet er under tilsyn.

(SE FI) VARNING!

Får endast användas i vatten där barnet bottnar och under tillsyn av en vuxen.

(F) VAROITUS!

Lelua saa käyttää vain aikuisen valvonnassa vedessä, jossa lapsi ylettäy pohjaan.

(HU) FIGYELMEZTETÉS!

Csak a gyermek magasságához képest biztonságos sekély vízben és felnőtt felügyelete mellett szabad használni!

(CZ) UPOZORNĚNÍ!

Používát pouze ve vodě takové hloubky, kde dítě stačí, a pouze pod dohledem dospělé osoby.

(EE) HOIATUS!

Kasutada ainult täiskasvanu järelevalve all vees, kus laps ulatub jalgadega põhja.

(LV) BRIDINĀJUMS!

Lietot tikai sekļā ūdenī un pieaugušo uzraudzībā.

(LT) ĮSPĖJIMAS!

Naudoti tik vaikai tinkamame gylje ir prižiūrint suaugusiesiems.

(SI) OPOZORILO!

Uporabljajte samo v vodi, primerno plitvi za otroka in pod nadzorom odrasle osebe.

(SK) UPOZORNENIE!

Používať len vo vode, v ktorej dieťa dočiahne na dno, a pod dohľadom dospeljej osoby.

(PL) OSTRZEŻENIE!

Do używania jedynie w wodzie na głębokości, na której dziecko wyczuwa dno pod nogami oraz pod nadzorem osoby dorosłej.

(TR CY) ΔΙΚΚΑΤ!

Sadece denetim altında ve sadece alçak sularda kullanın.

(GR CY) Προειδοποίηση!

Να χρησιμοποιείται μόνο σε νερά όπου πατώνει το παιδί και υπό την επίβλεψη ενηλίκου.

(RO) AVERTISMENT!

A se utiliza numai acolo unde copilul poate sta în picioare în apă și este sub supraveghere.

(BG) Внимание!

Да се използва само във вода, която е дълбока до нормалния ръст на детето, и под надзора на възрастен.

(HR) UPOZORENJE!

Koristiti samo u plitkoj vodi pod nadzorom odraslih.

(RU) Внимание!

Использовать только на мелководье под наблюдением взрослых.

(CN) 警告! 本玩具可在水上玩耍, 请在成人监护下使用, 避免发生溺水危险.Abbildungen können vom Original abweichen. / Product may differ from image shown.
Les illustrations peuvent différer de l'original. / Afbeeldingen kunnen verschillen van het werkelijke artikel.

www.playmobil.com

© 2011 geobra Brandstätter Stiftung & Co.KG

Brandstätterstr. 2-10

90513 Zirndorf, Germany.

No. 30 82 6342 02.21