

playmobil®

9488



WARNING:
CHOKING HAZARD

Contains a small ball and small parts.
Not for children under 3 years.

Wichtige Unterlagen, bitte sorgfältig aufbewahren!
Important: Please keep these instructions for future reference!
Documents importants, à conserver soigneusement!
Belangrijke documenten, bewaar deze zorgvuldig!

"Ne concerne que les USA"



1

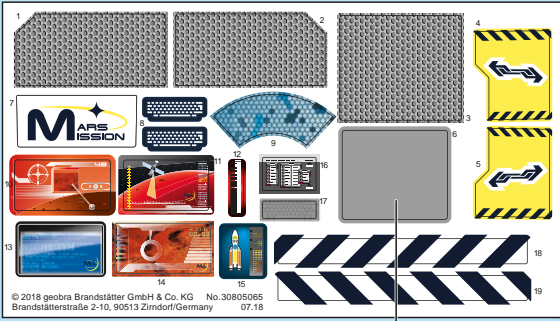

6

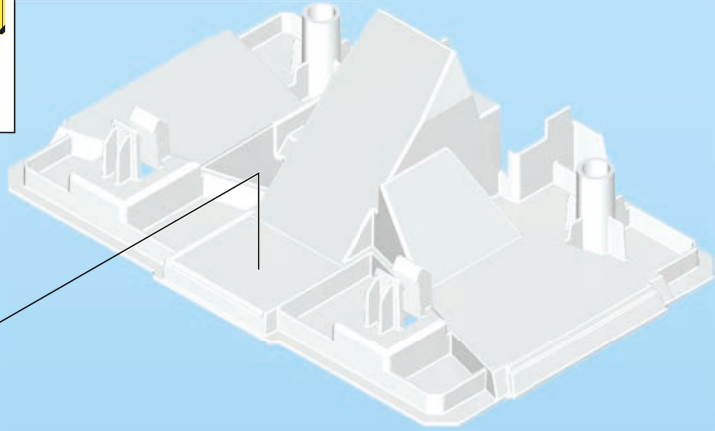

2

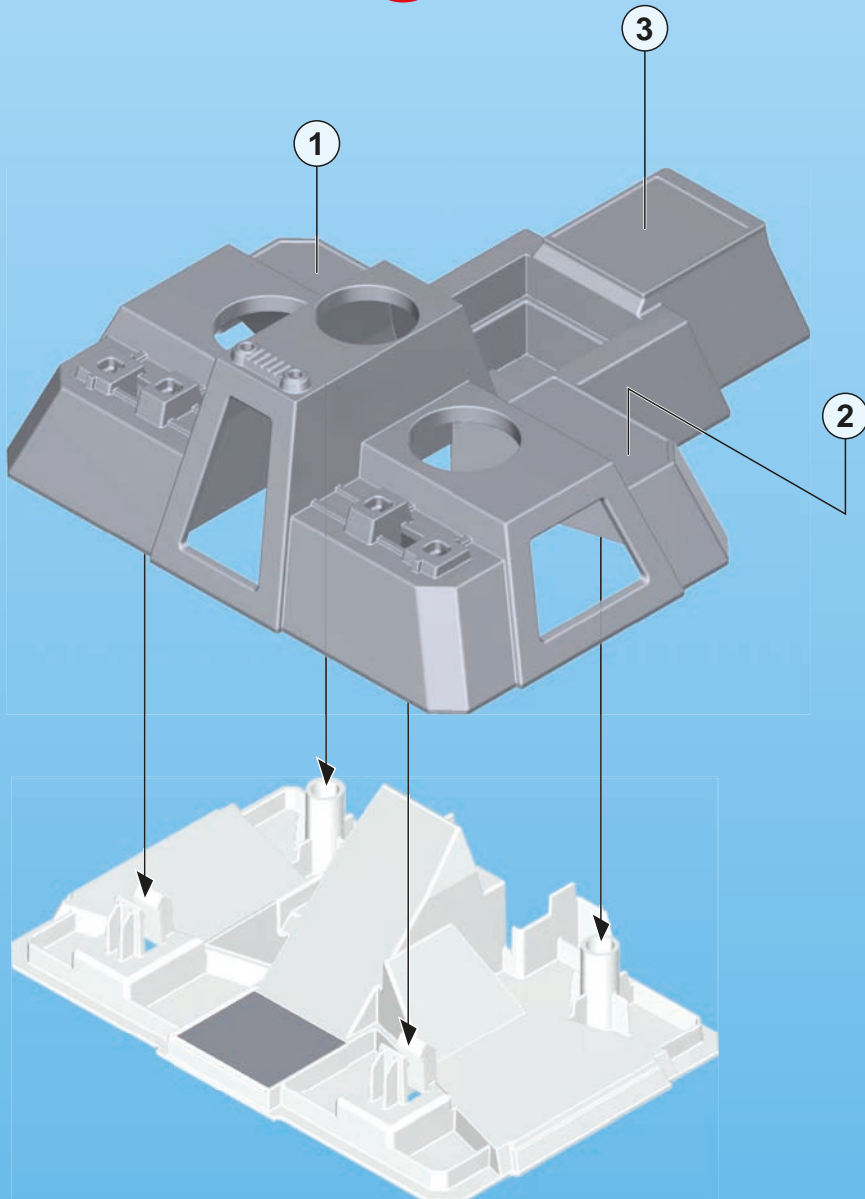

3

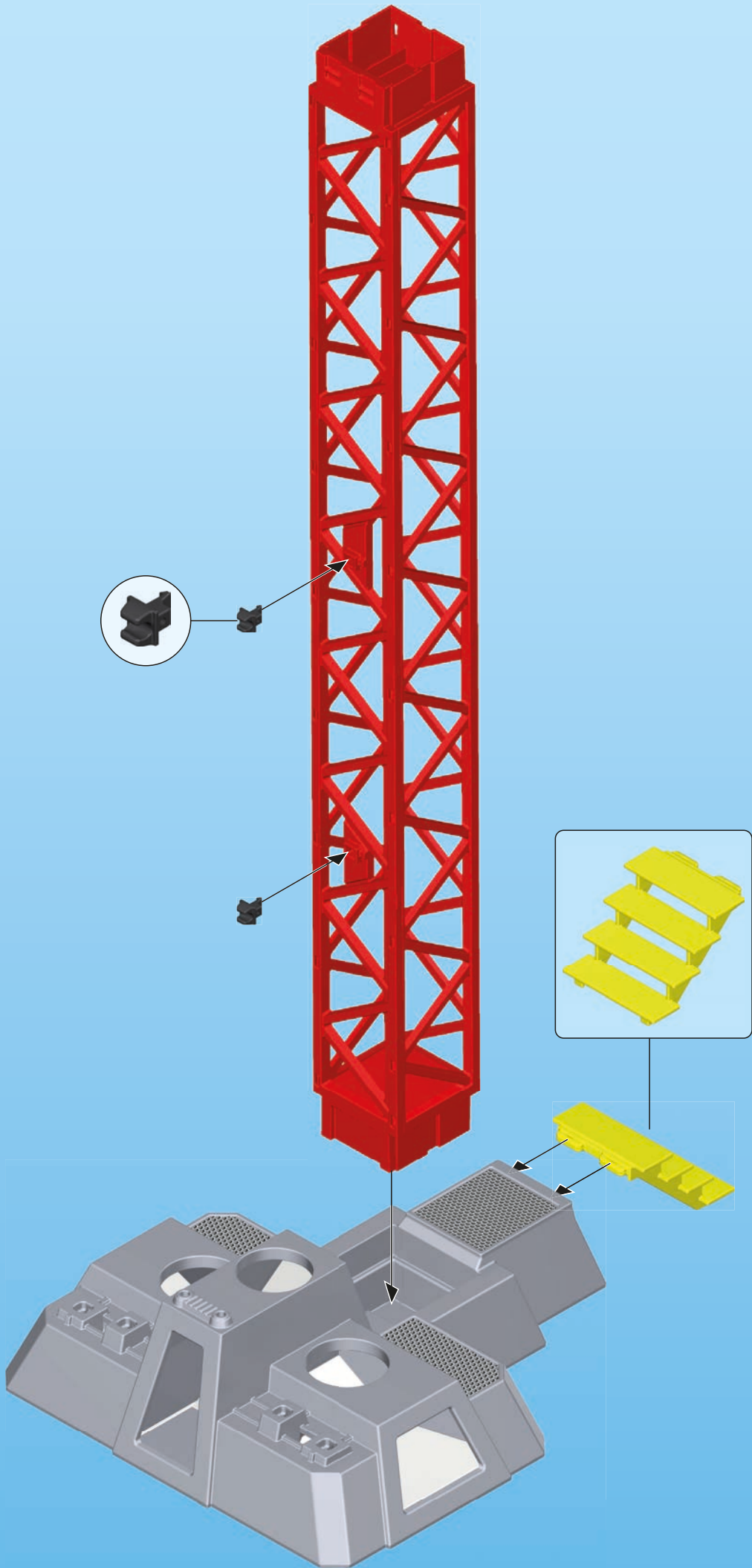

1

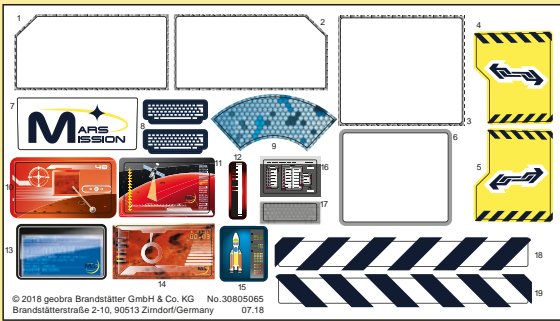

4x

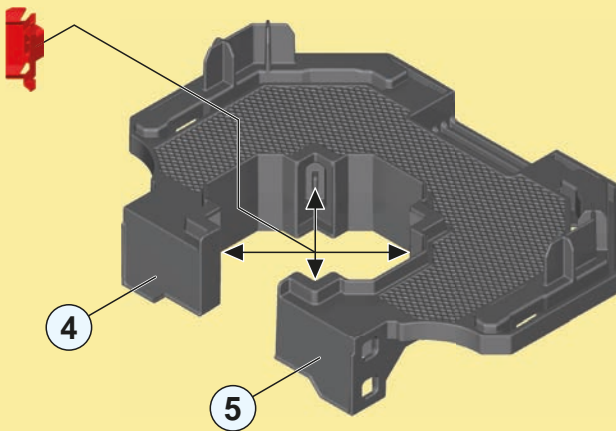

2

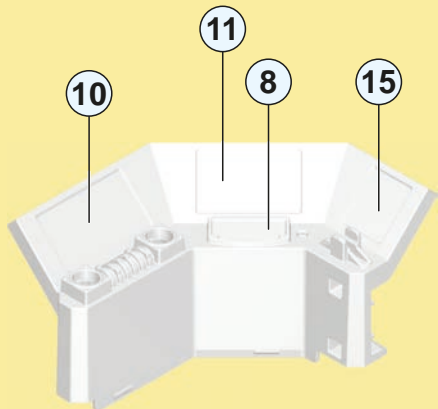

3

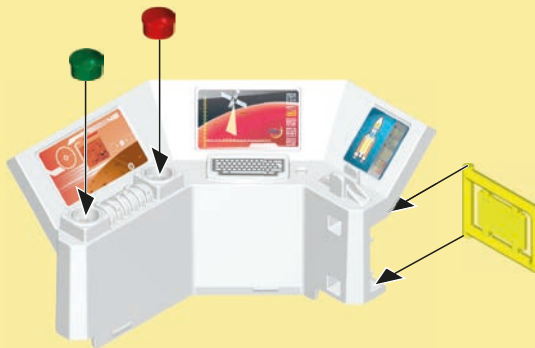

4

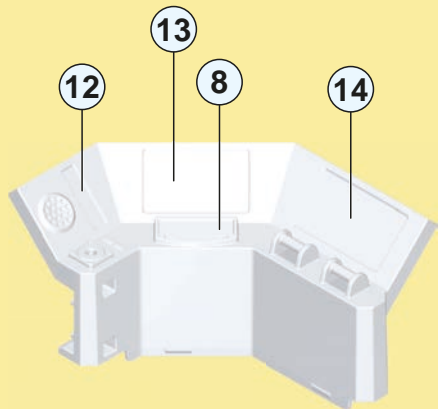

5



6

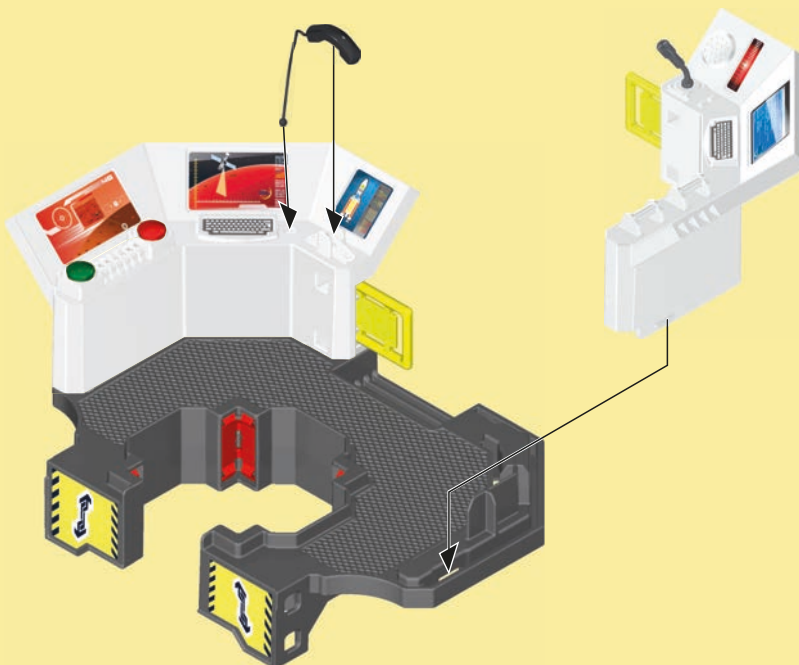

4

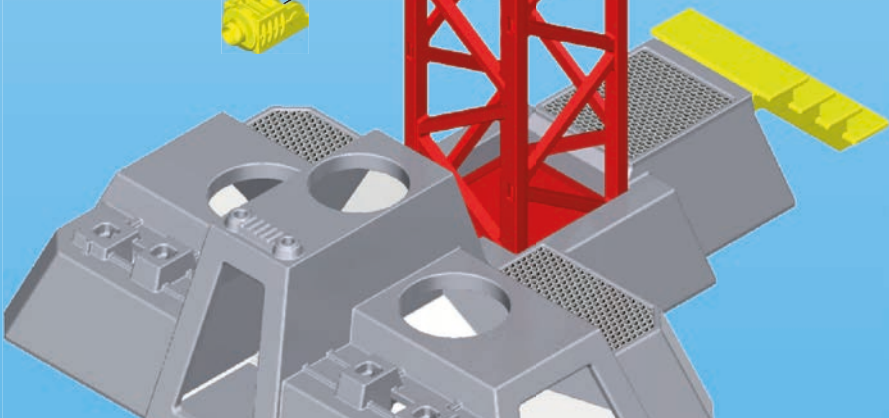
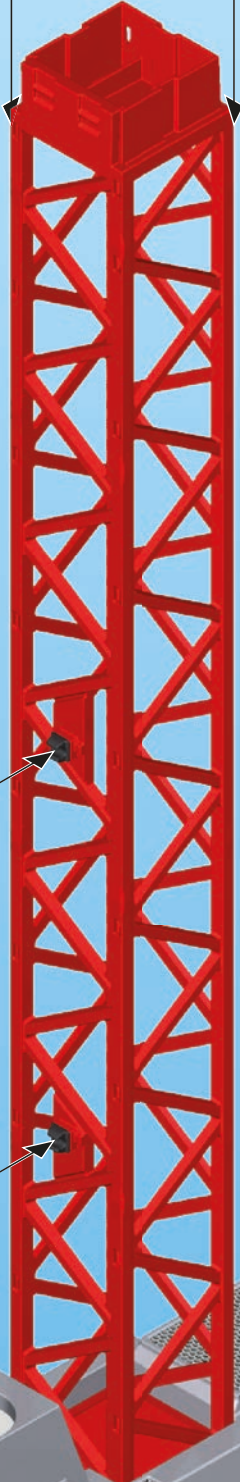

2x

5

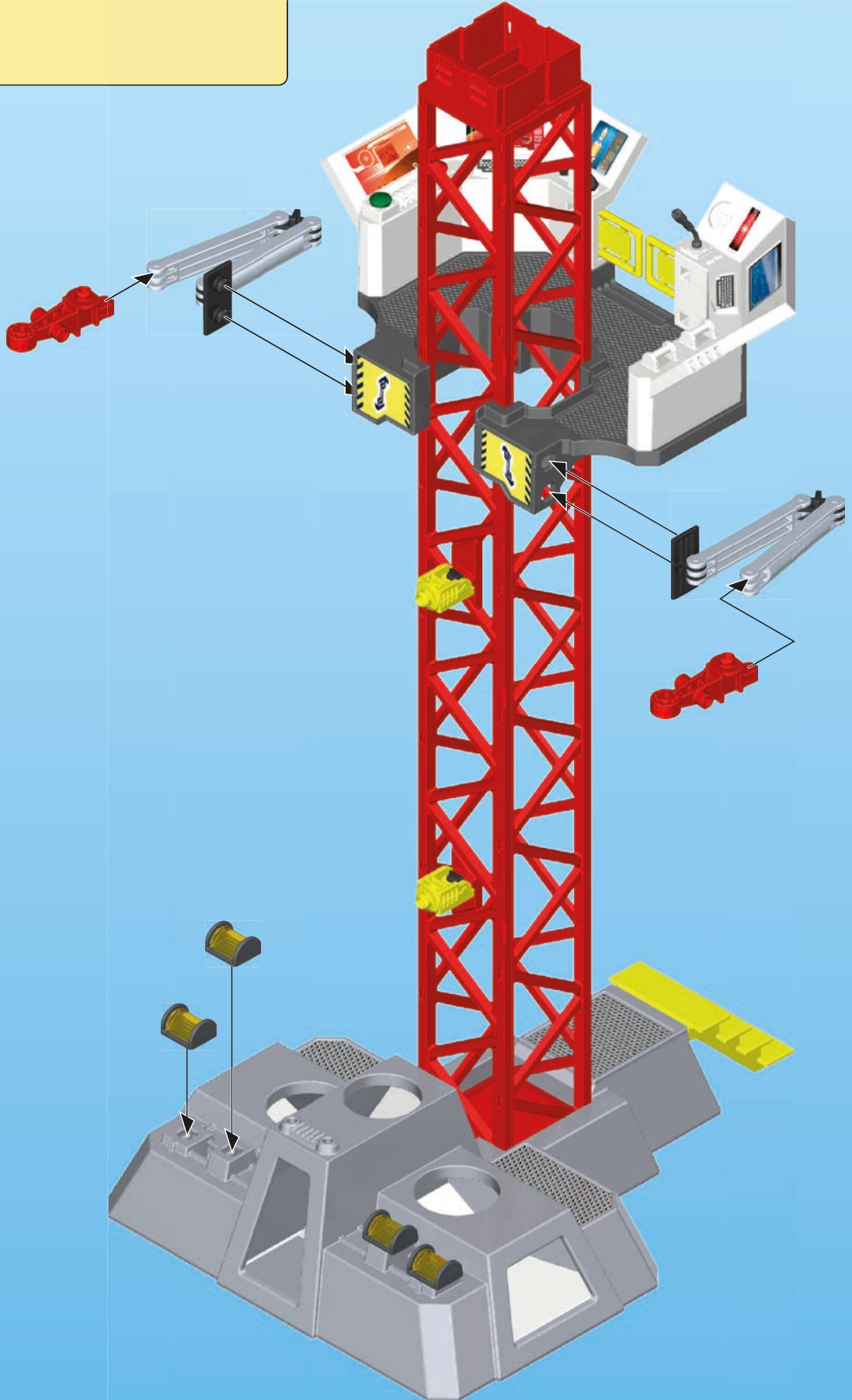
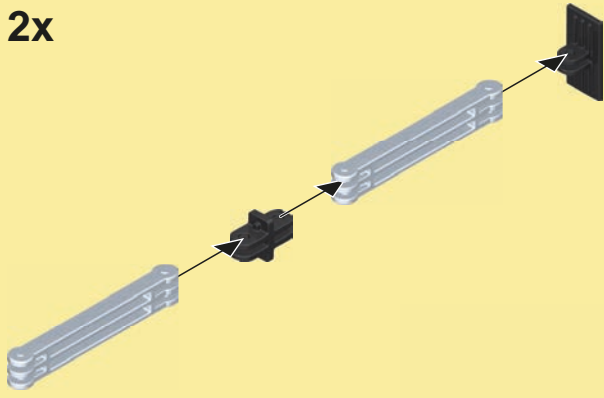

4x



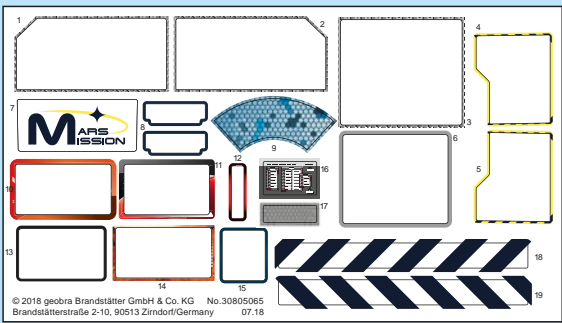

6

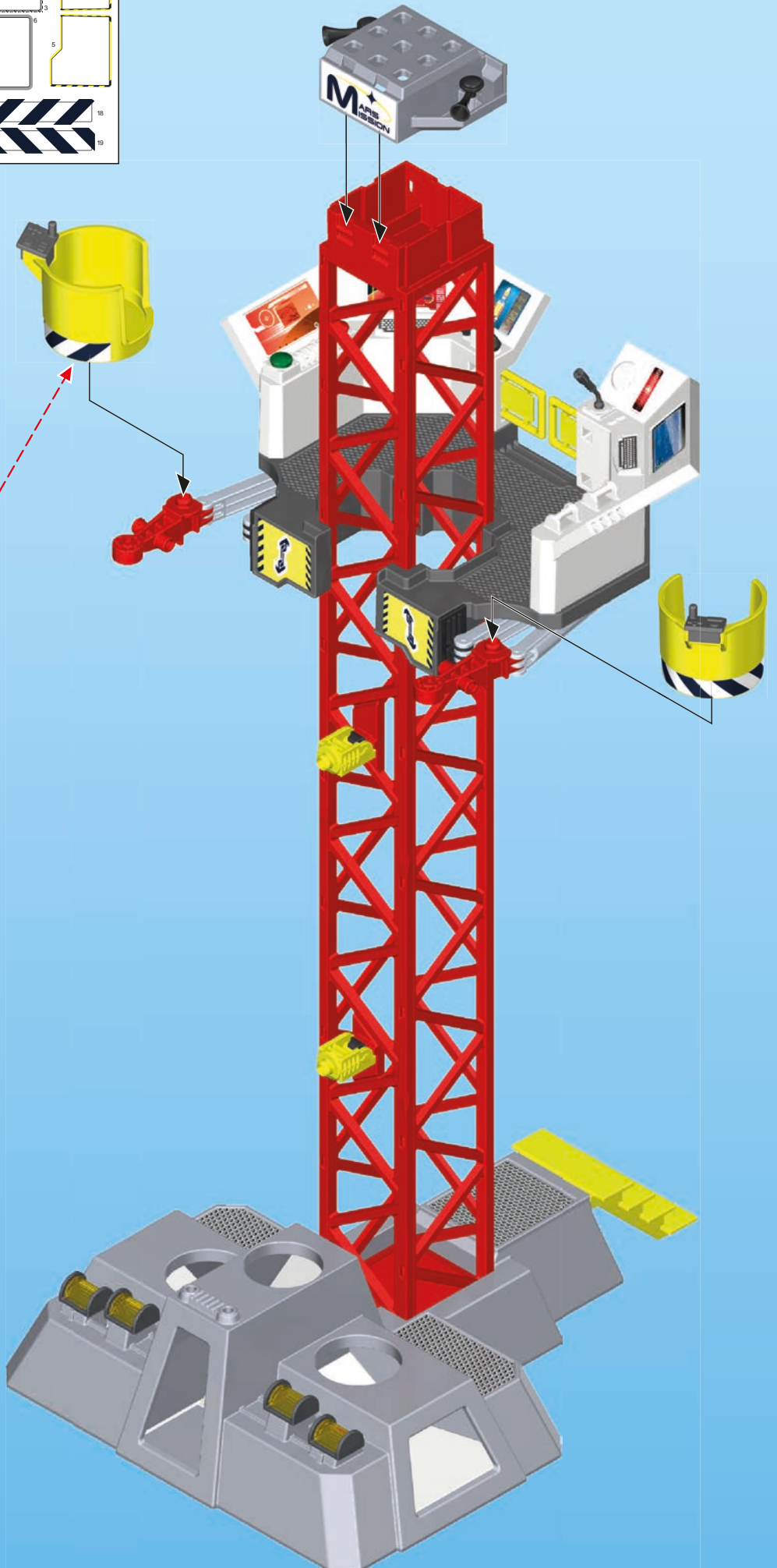
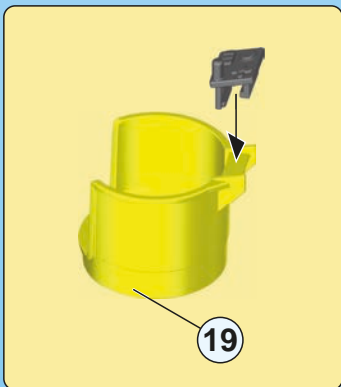
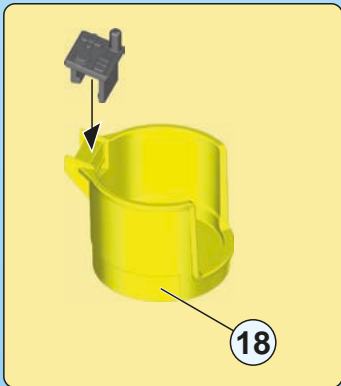
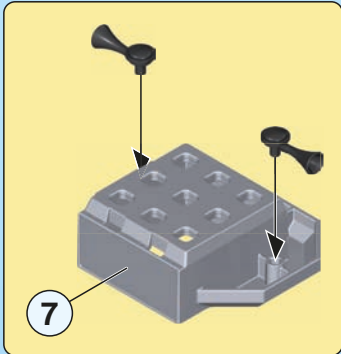

1

+ 2x Mignon 1,5V
R6 • LR6 • AA -

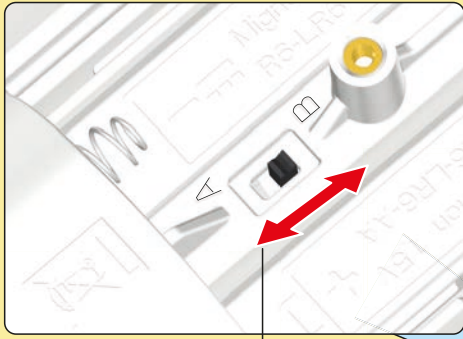

A/B

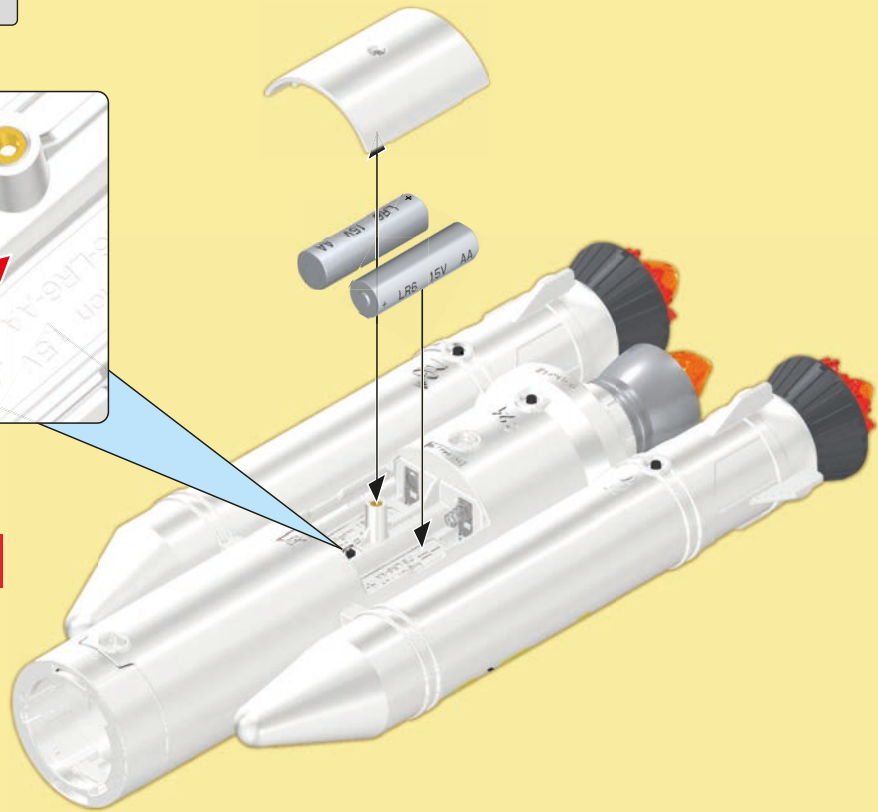
2

An / Aus
On / Off
Marche / Arrêt

~ 15 sec.

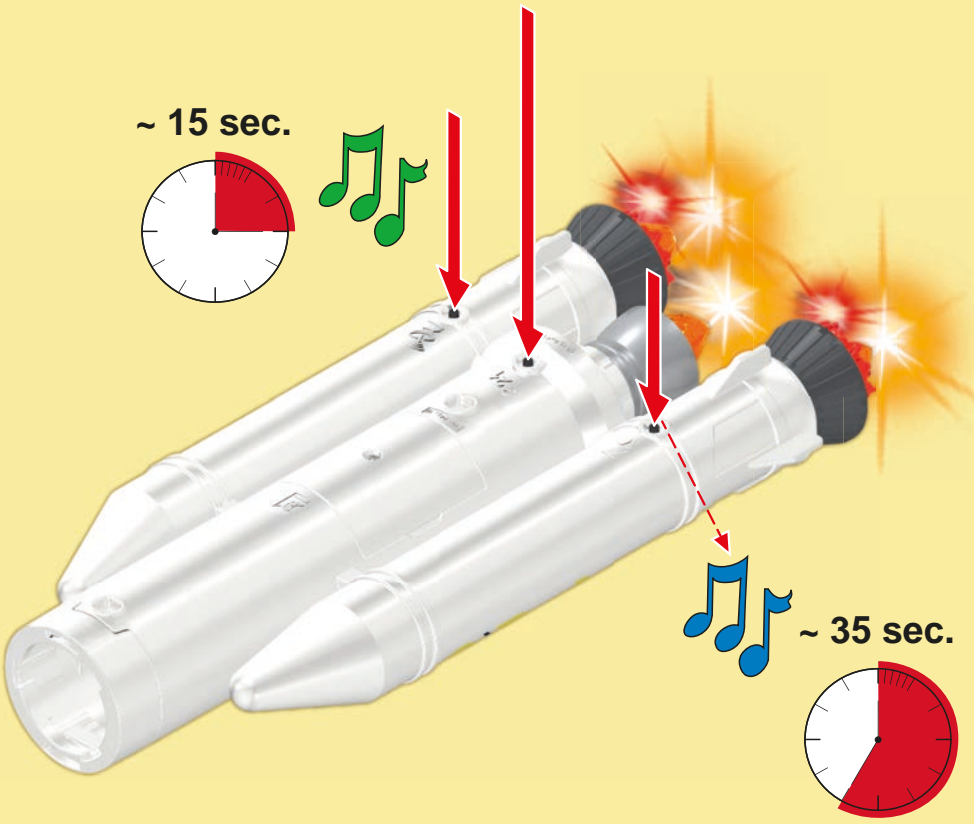

~ 35 sec.

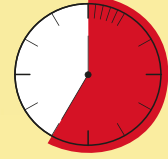

7

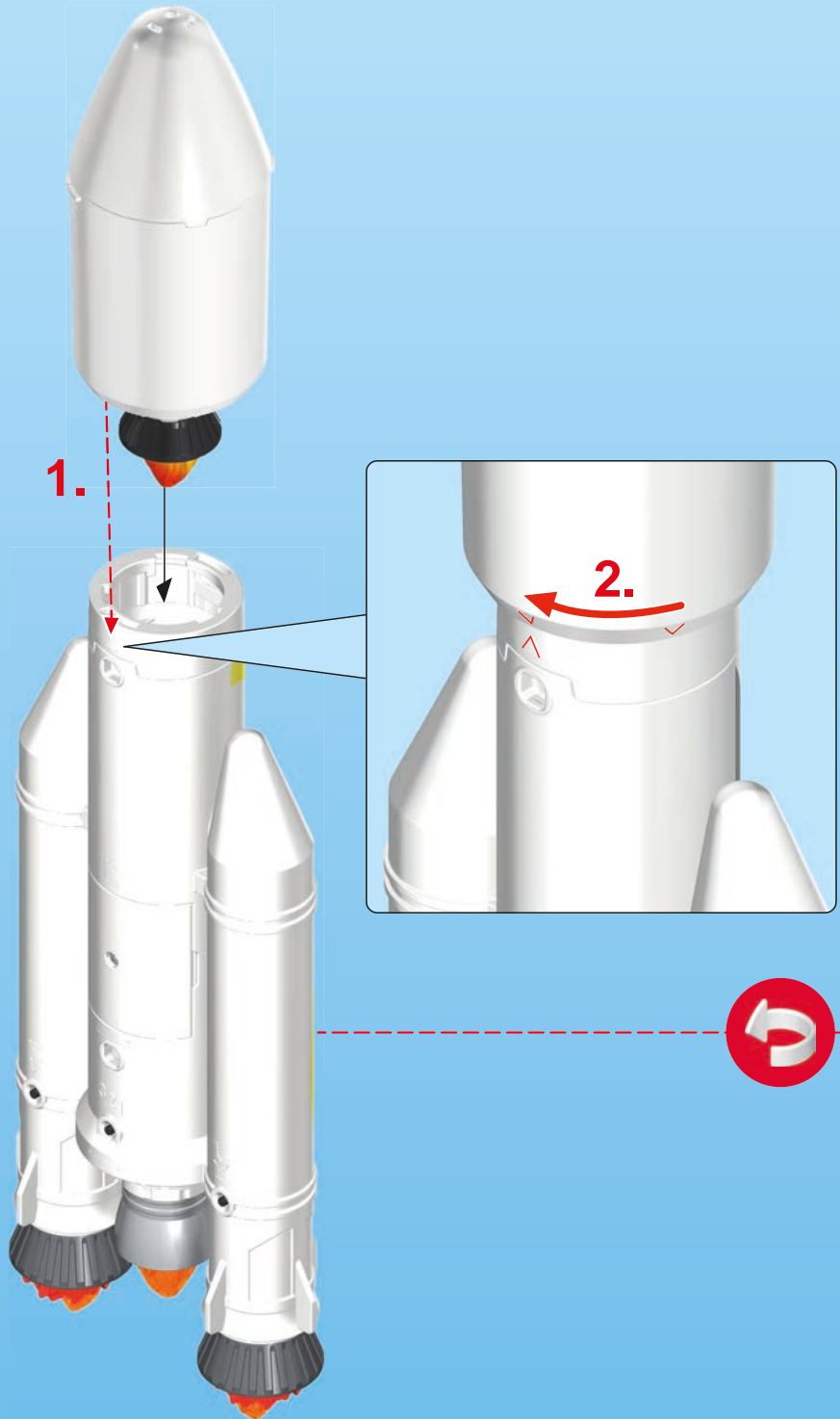
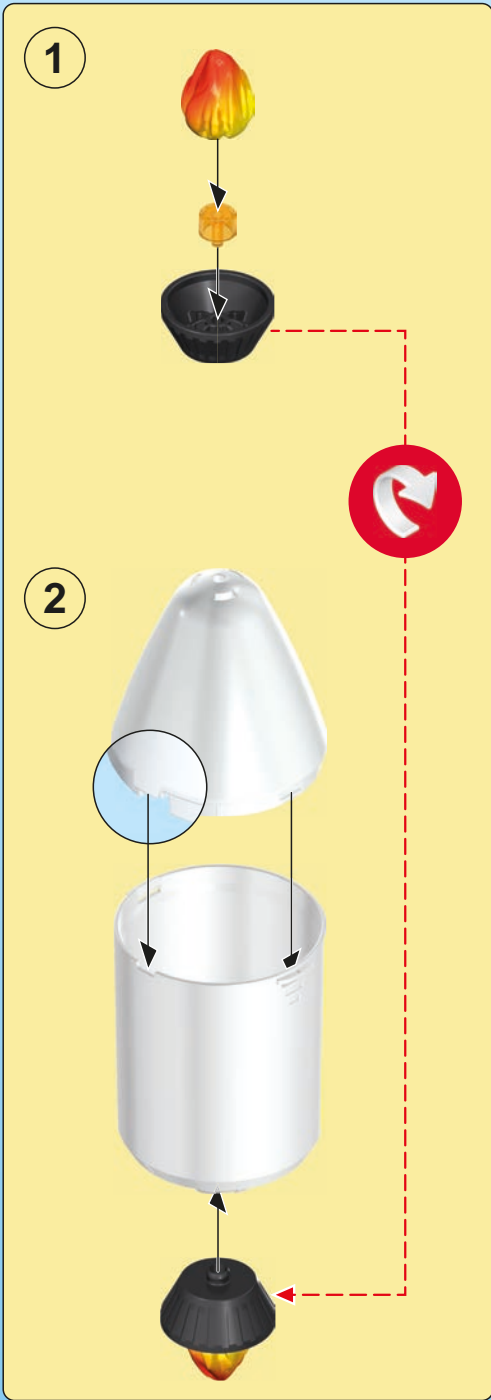

8

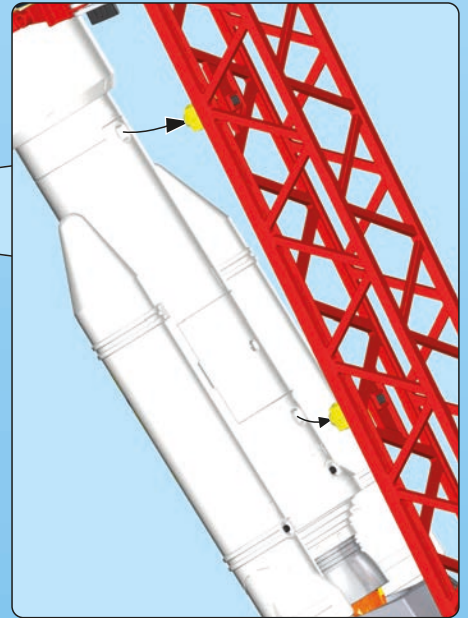
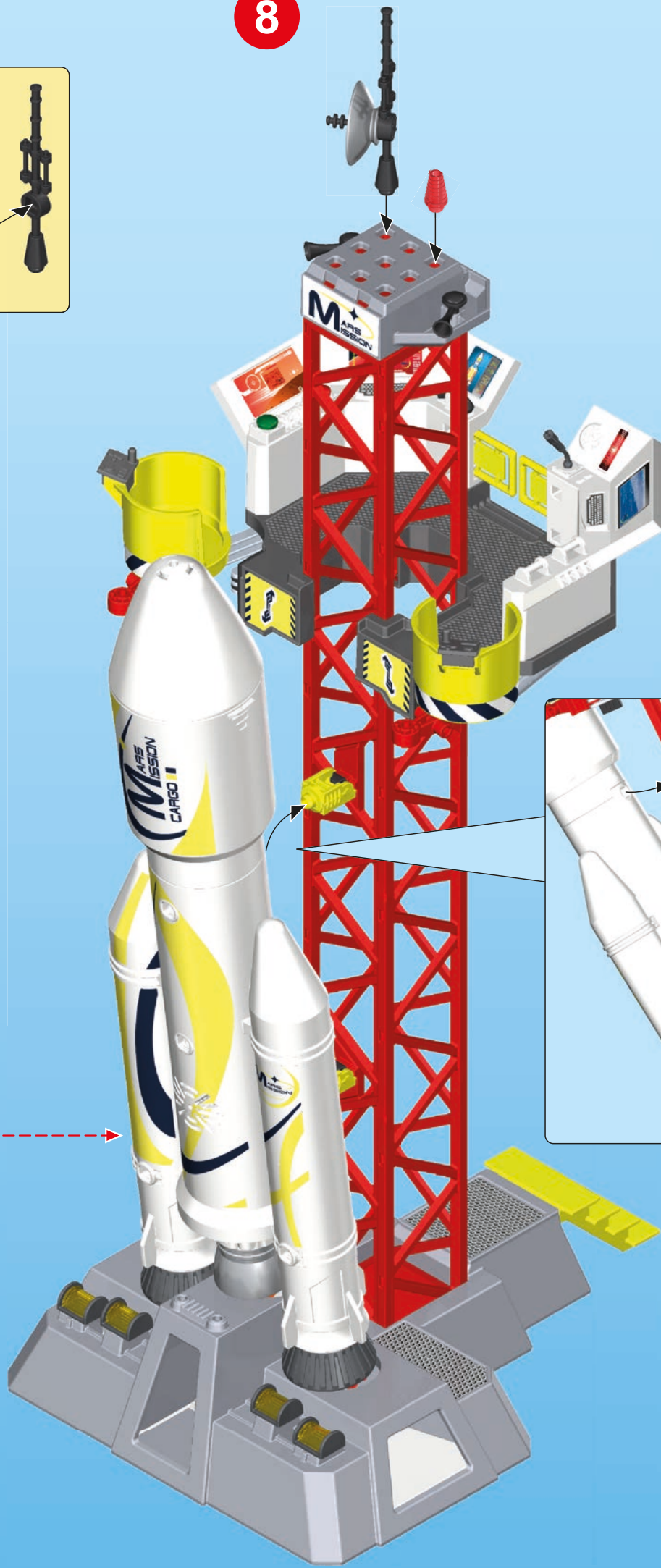
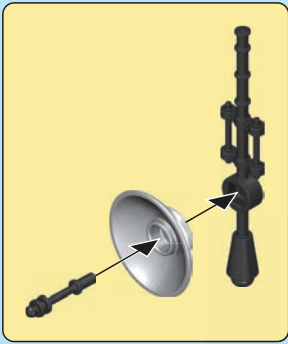

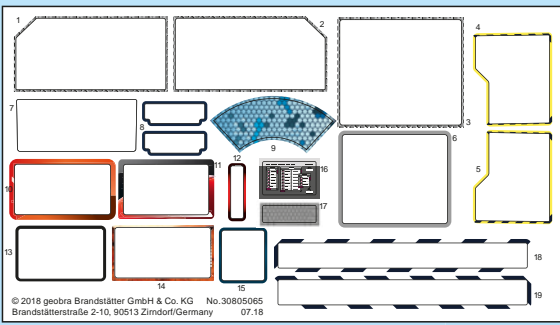

9

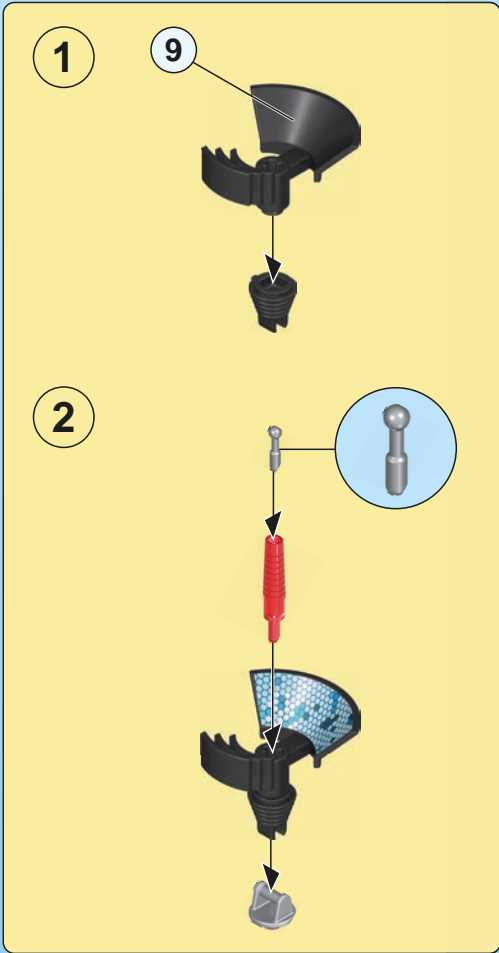
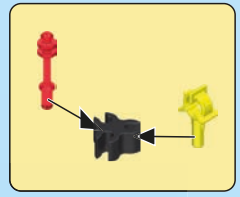

10

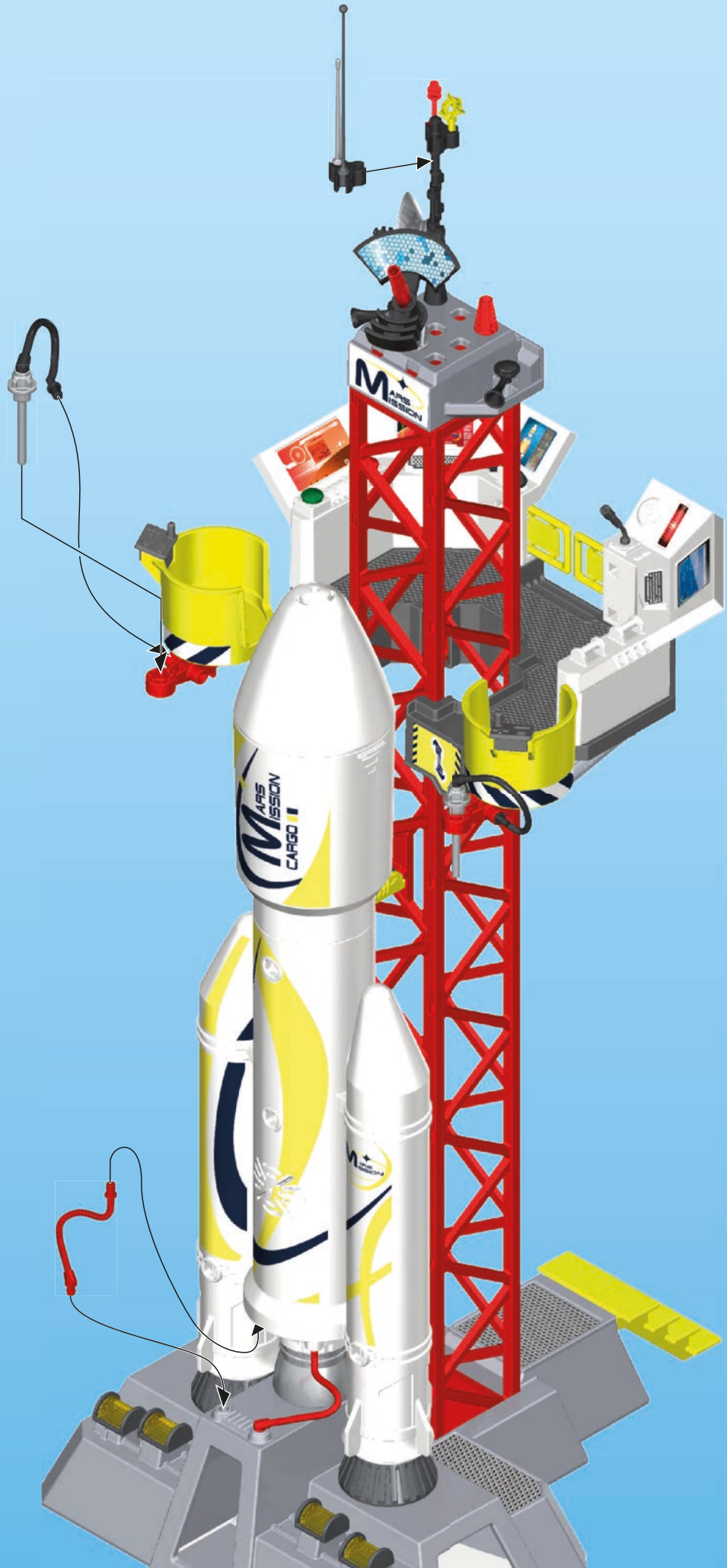
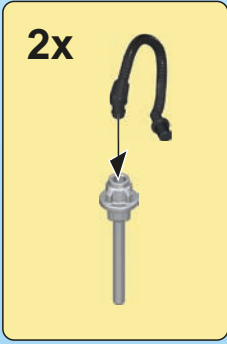
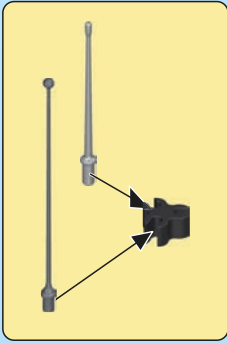

11

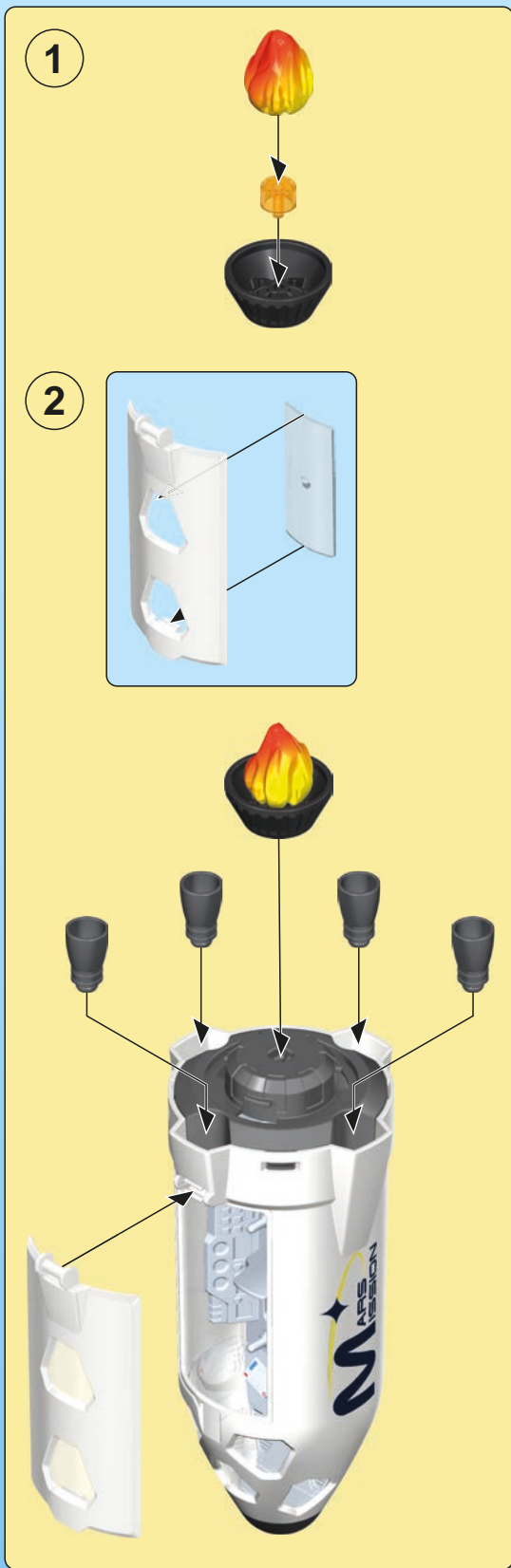

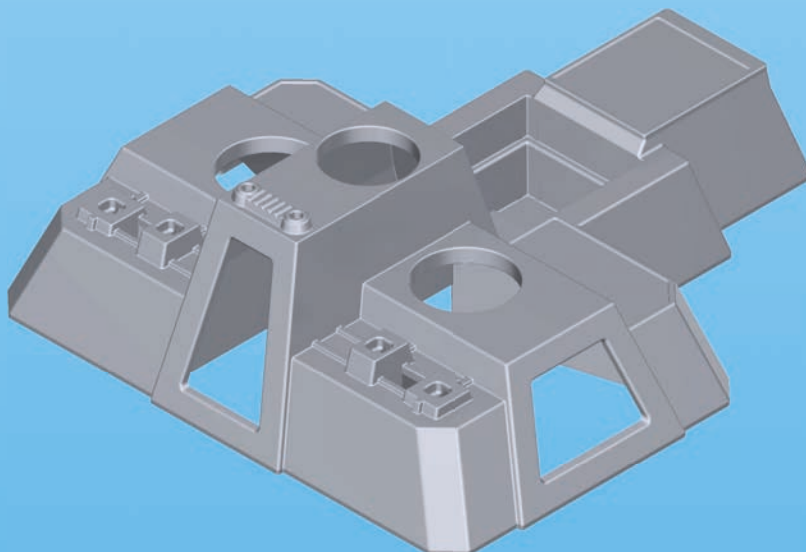
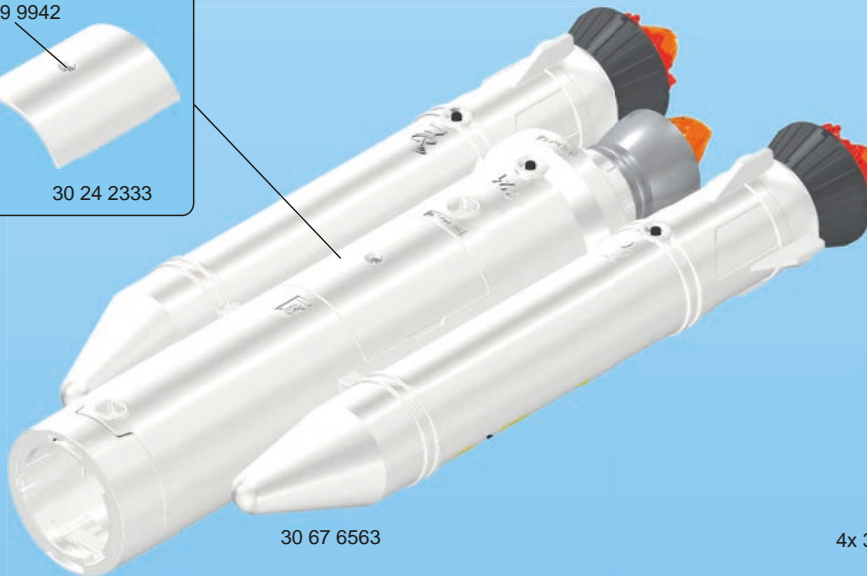
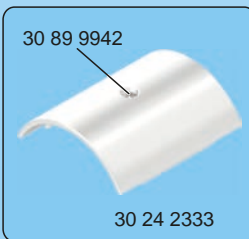
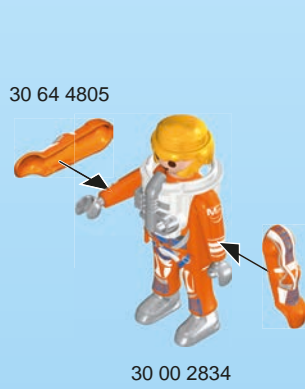
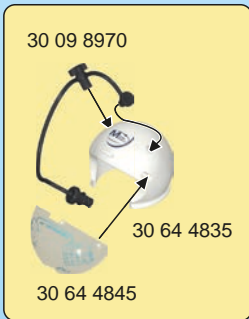
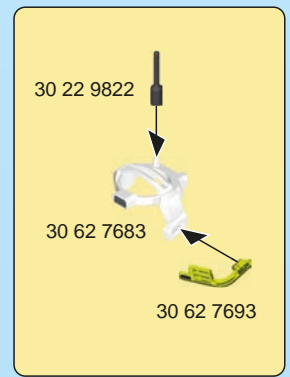
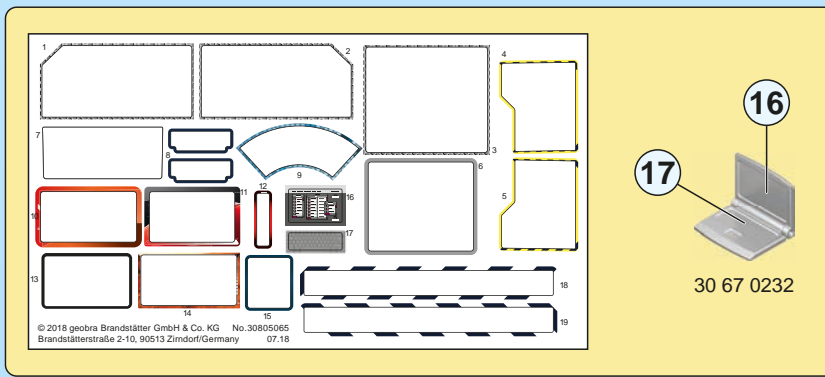
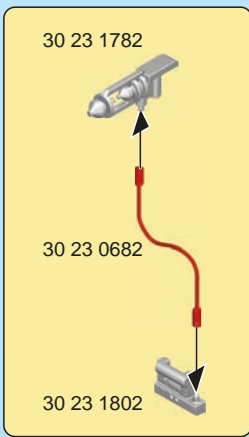

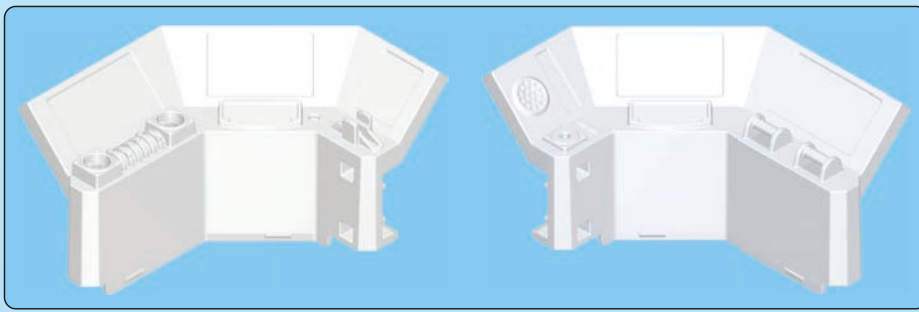

30 51 4832

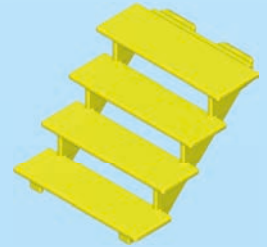

30 08 7362



30 24 2443



30 23 7882

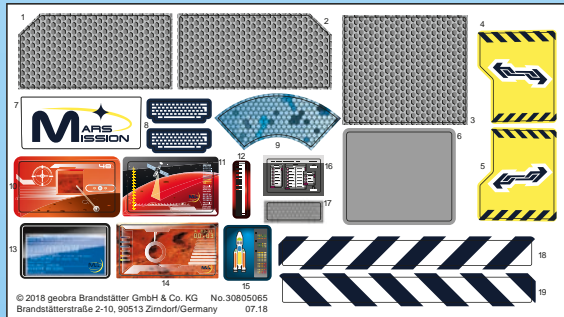

30 80 5065



30 64 4865

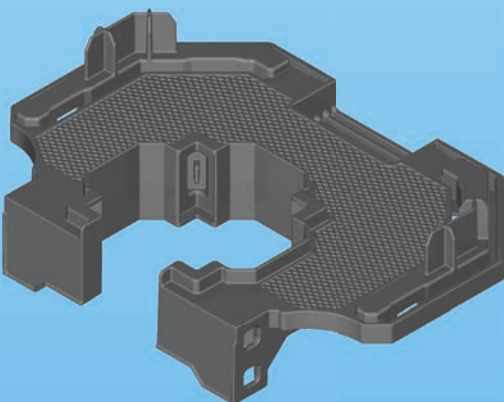

30 08 7372



2x 30 21 5682

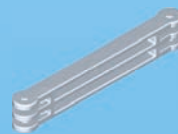

4x 30 24 2083

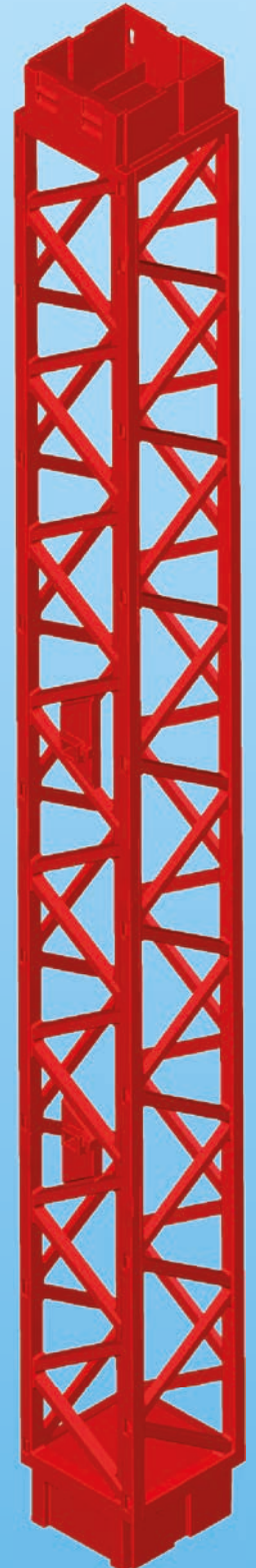

30 67 6553



2x 30 21 3740



30 24 2583

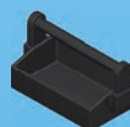

30 65 3023



30 08 7342

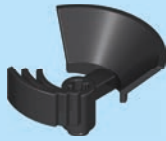

30 21 5170



30 22 3200



30 03 2940



2x 30 30 27 2950



2x 30 30 24 2493



2x 30 23 5630



2x 30 30 08 7382



2x 30 30 24 2473



2x 30 30 24 2513



2x 30 30 08 7302



30 21 3890



30 21 3770



30 21 3060



2x 30 30 09 9920



2x 30 30 24 2483



2x 30 30 21 6370



30 03 2450



30 21 9830



30 24 7172



30 23 1672



4x 30 08 7312



4x 30 29 0770



30 25 2343



2x 30 02 5200



30 21 3470



30 05 9112



30 24 2403



30 24 2393



30 51 4852



30 51 0332



2x 30 07 7040

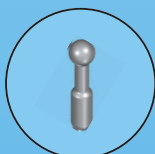

30 27 5500



2x 30 22 3662

UK-Importer:
 Playmobil UK Ltd.
 Regency House
 1 Miles Gray Road
 Basildon
 Essex
 SS14 3RW
 UK





(DE) (AT) (CH) (LU) (BE) Denken Sie an den Schutz der Umwelt !

- Ihr Gerät enthält wertvolle Rohstoffe, die wieder verwertet werden können.
- Geben Sie Ihr Gerät deshalb bitte bei einer Sammelstelle Ihrer Stadt oder Gemeinde ab.

(GB) (MT) (IE) Environment protection first !

- Your appliance contains valuable materials which can be recovered or recycled.
- Leave it at a local civic waste collection point.

(FR) (LU) (CH) Participons à la protection de l'environnement !

- Votre appareil contient de nombreux matériaux valorisables ou recyclables.
- Confiez celui-ci dans un point de collecte pour que son traitement soit effectué.

(ES) ¡¡ Participe en la conservación del medio ambiente !!

- Su electrodoméstico contiene materiales recuperables y/o reciclables.
- Entréguelo al final de su vida útil, en un Centro de Recogida Específico o en uno de nuestros Servicios Oficiales Post Venta donde será tratado de forma adecuada.

(NL) (BE) Samen het milieu beschermen !

- Uw product bevat meerdere recycleerbare materialen
- Breng deze naar een afval-inzamelpunt.

(BE) Participons à la protection de l'environnement !

- Votre appareil contient de nombreux matériaux valorisables ou recyclables.
- Confiez celui-ci dans un point de collecte ou à défaut dans un centre service agréé pour que son traitement soit effectué.

(IT) (CH) Partecipiamo alla protezione dell'ambiente !

- Il vostro apparecchio è composto da diversi materiali che possono essere riciclati.
- Lasciatelo in un punto di raccolta o presso un Centro Assistenza Autorizzato.

(DK) Vi skal alle være med til at beskytte miljøet!

- Apparaten indeholder mange materialer, der kan genvindes eller genbruges.
- Bring det til et specialiseret indsamlingssted for genbrug eller et autoriseret serviceværksted, når det ikke skal bruges mere.

(SE) (FI) Var rädd om miljön!

- Din apparat innehåller olika material som kan återanvändas eller återvinnas.
- Lämna den på en återvinningsstation eller på en auktoriserad serviceverkstad för omhändertagande och behandling.

(PT) Protecção do ambiente em primeiro lugar!

- O seu produto contém materiais que podem ser recuperados ou reciclados.
- Entregue-o num ponto de recolha para possibilitar o seu tratamento.

(FI) Huolehtikaamme ympäristöstä!

- i Laitteesi on varustettu monilla arvokkailla ja kierrätettävillä materiaaleilla.
- Toimita laitteesi keräyspisteeseen tai sellaisen puuttuessa vaikka valtuutettuun huoltokekkukseen, jotta laitteen osat varmasti kierrätetään.

(HU) Első a környezetvédelem!

- Az Ön terméke értékes újrahasznosítható anyagokat tartalmaz.
- Kérjük készülékét ne dobja ki, hanem adja le az erre a célra kijelölt gyűjtőhelyen.

(CZ) Podílejme se na ochraně životního prostředí!

- Váš přístroj obsahuje četné zhodnotitelné nebo recyklovatelné materiály.
- Světe je sběrnému místu nebo, neexistuje-li, smluvnímu servisnímu středisku, kde s ním bude naloženo odpovídajícím způsobem.

(SI) Sodelujmo pri varovanju okolja!

- Vaš aparat vsebuje številne dele, ki imajo svojo vrednost ali jih je še mogoče uporabiti.
- Oddajte ga na mestu za zbiranje odpadkov ali pa na pooblaščenem servisu, da bo šel v predelavo.

(SK) Podieľajme sa na ochrane životného prostredia!

- Váš prístroj obsahuje četné zhodnotiteľné alebo recyklovateľné materiály.
- Zverte ho sbornému miestu alebo, ak neexistuje, zmluvnému servisnému stredisku, kde s ním bude naložené zodpovedajúcim spôsobom.

(PL) Bierzmy czynny udział w ochronie środowiska!

- Twoje urządzenie jest zbudowane z materiałów, które mogą być poddane ponownemu przetworzeniu lub recyklingowi.
- W tym celu należy je dostarczyć do wyznaczonego punktu zbiórki.

(GR) (CY) Ας συμβάλουμε κι εμείς στην προστασία του περιβάλλοντος!

- Η συσκευή σας περιέχει πολλά αξιοποιήσιμα ή ανακυκλώσιμα υλικά.
- Παραδώστε την παλιά συσκευή σας σε κέντρο διαλογής ή σε ένα εξουσιοδοτημένο κατάστημα εσέρβις.

(RO) Țineți cont de protecția mediului !

- Aparatul dvs. conține materii prime valoroase care pot fi revalorificate.
- Din acest motiv vă rugăm să predați aparatul dvs. la un centru de colectare din orașul sau comuna dvs.

(BG) Мислете за околната среда !

- Вашият уред съдържа ценни суровини, които могат да бъдат рециклирани.
- Затова върнете своя електроуред на специално място за събиране на таква отпадъци във Вашия град или община.

(RU) Подумайте о защите окружающей среды !

- Ваше устройство содержит ценное сырье, которое может быть переработано.
- Поэтому, пожалуйста, верните ваше устройство в пункт сбора в вашем городе или муниципалитете.

(DE) (AT) (CH) (LU) (BE) ACHTUNG! Das Spielzeug erzeugt Lichtblitze, die bei empfindlichen Personen Epilepsie auslösen können.

(US) (GB) (CA) (MT) (IE) WARNING! This toy produces flashes that may trigger epilepsy in sensitised individuals.

(FR) (CA) (BE) (LU) (CH) ATTENTION! Ce jouet crée des flashes lumineux susceptibles de déclencher des crises d'épilepsie chez certaines personnes.

(ES) (MX) ¡ADVERTENCIA! El juguete genera destellos de luz que, en personas sensibles, pueden provocar epilepsia.

(NL) (BE) WAARSCHUWING! het speelgoed veroorzaakt lichtflitsen, die bij gevoelige personen epilepsie kunnen veroorzaken.

(IT) (CH) AVVERTENZA! Il giocattolo genera lampi di luce che possono provocare epilessia nei soggetti sensibili.

(PT) ATENÇÃO! O brinquedo imite raios de luz que, em caso de pessoas sensíveis pode provocar epilepsia.

(DK) ADVARSEL! Dette legetøj frembringer lysglimt, der kan fremprovokere epileptiske anfald hos særlig følsomme mennesker.

(NO) ADVARSEL! Leketøyet fremkaller lynlys som kan utløse epilepsi hos ømfintlige personer.

(SE) (FI) VARNING! Den här leksaken avger ljusblixtar, som kan utlösa epilepsi hos känsliga personer.

(FI) VAROITUS! Lelu välkyy ja voi aiheuttaa epilepsia-kohtauksen herkimmillä henkilöillä.

(HU) FIGYELMEZTETÉS! A játékszer fényfelvillanásokat okoz, amely az arra érzékeny személyeknél epilepsziás rohamokat válthat ki!

(CZ) UPOZORNĚNÍ! Hračka vydává světelné záblesky, které mohou u citlivých osob vyvolat epilepsii.

(EE) HOIATUS! Mänguasi tekitab valgusvälkatusi, mis võivad tundlikel inimestel vallandada epileptilisi hoogusid.

(LV) BRĪDINĀJUMS! Rotaļlietai darbojoties, rodas gaismas zibšņi, kas var izraisīt epilepsijas lēkmi jutīgām personām.

(LT) ĮSPĖJIMAS! Žaislas generuoja šviesos blyksnius, kurie jautriems asmenims gali sukelti epilepsiją.

(SI) OPOZORILO! Igrača oddaja bliske, ki pri občutljivih osebah lahko lahko sprožijo epileptične napade.

(SK) UPOZORNENIE! Hračka vytvára záblesky svetla, ktoré môžu u citlivých osôb vyvolať epilepsiu.

(PL) OSTRZEŻENIE! Zabawka wytwarza błyski, które u osób wrażliwych mogą wywoływać napady epilepsji.

(TR) (CY) ΔΙΚΚΑΤ! Oyncaak, hassas kişilerde epilepsi nöbetine neden olabilecek ışık flaşları oluşturmaktadır.

(GR) (CY) ΠΡΟΕΙΔΟΠΟΙΗΣΗ! Το παιχνίδι παράγει αστραπιαίο φως που μπορεί να προκαλέσει επιληψία σε ευαίσθητα άτομα.

(RO) AVERTISMENT! Jucăria produce pulsuri de lumină care pot declanșa crize de epilepsie la persoanele sensibile.

(BG) Внимание! Играчката произвежда светкавици, които могат да предизвикат епилепсия при чувствителни лица.

(HR) UPOZORENJE! Igračka proizvodi bljeskove koji kod osjetljivih osoba mogu izazvati epilepsiju.

(RU) Внимание! игрушка генерирует вспышки света, которые могут вызвать эпилептический припадок у чувствительных людей.

(CN) 警告! 本玩具产生闪光, 在敏感者有导致癫痫发作的可能。

9488 + 9805

9805

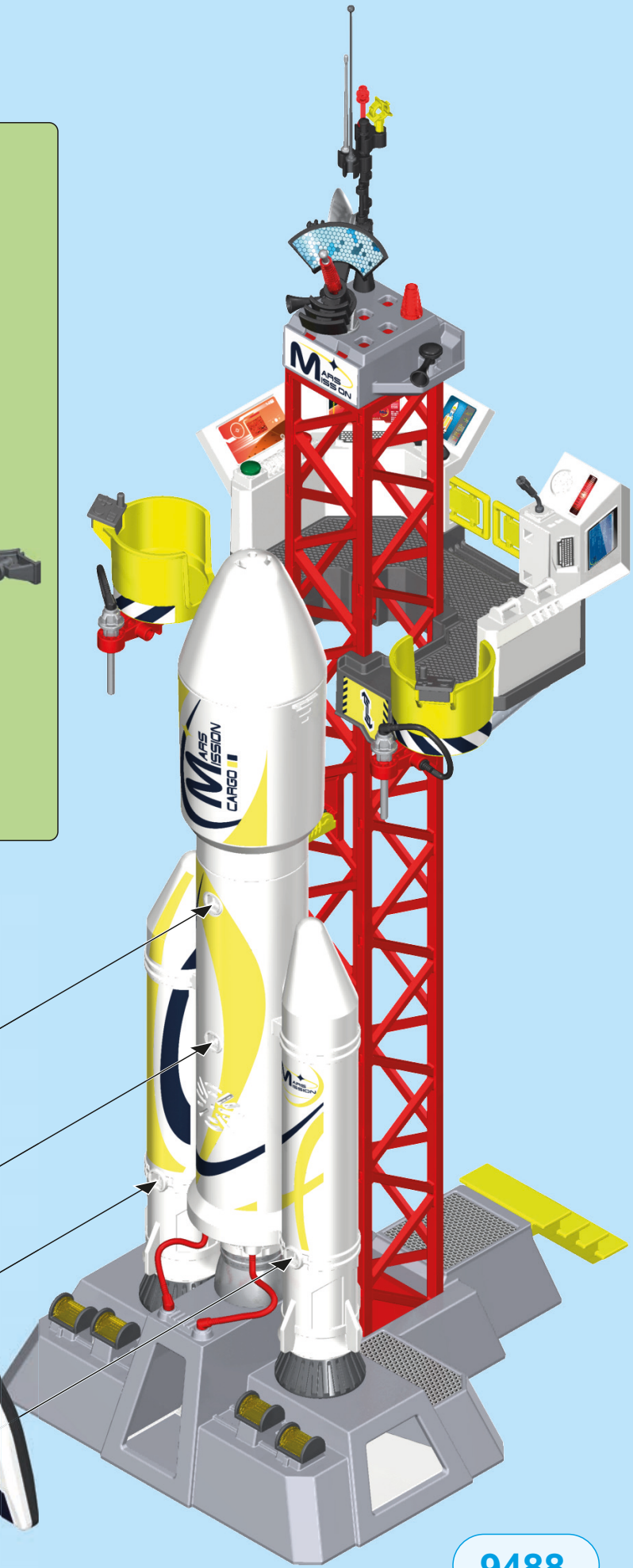
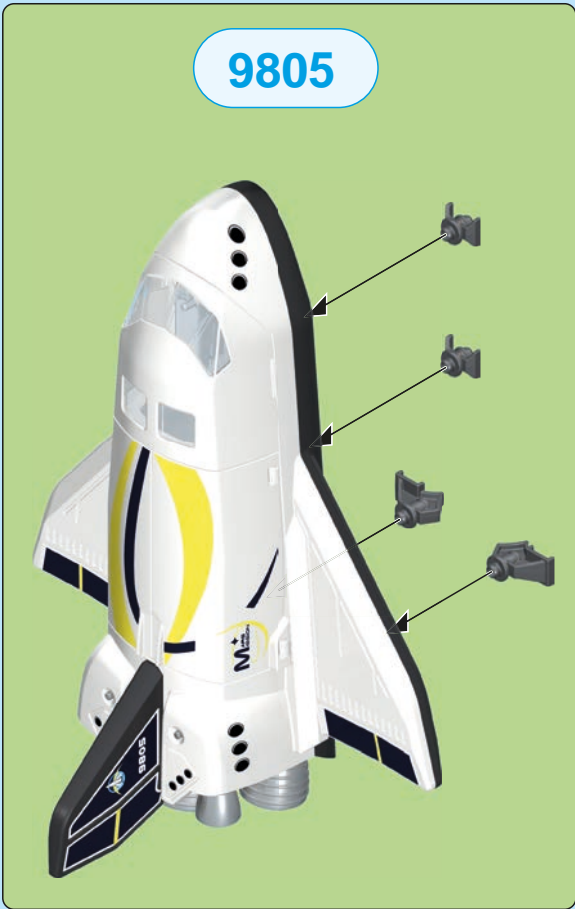

9488

9488

9487

9488 + 9487

9488

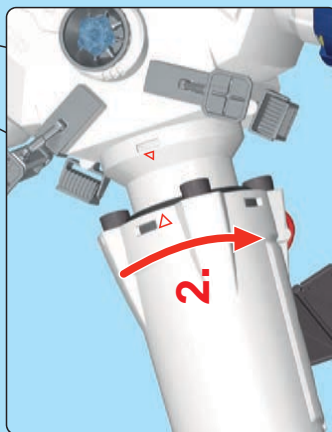
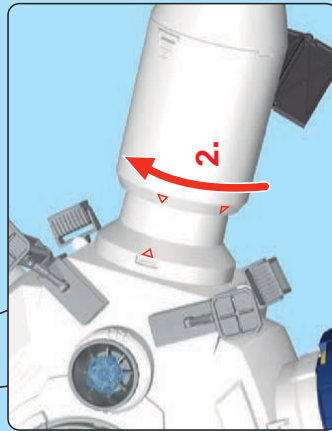
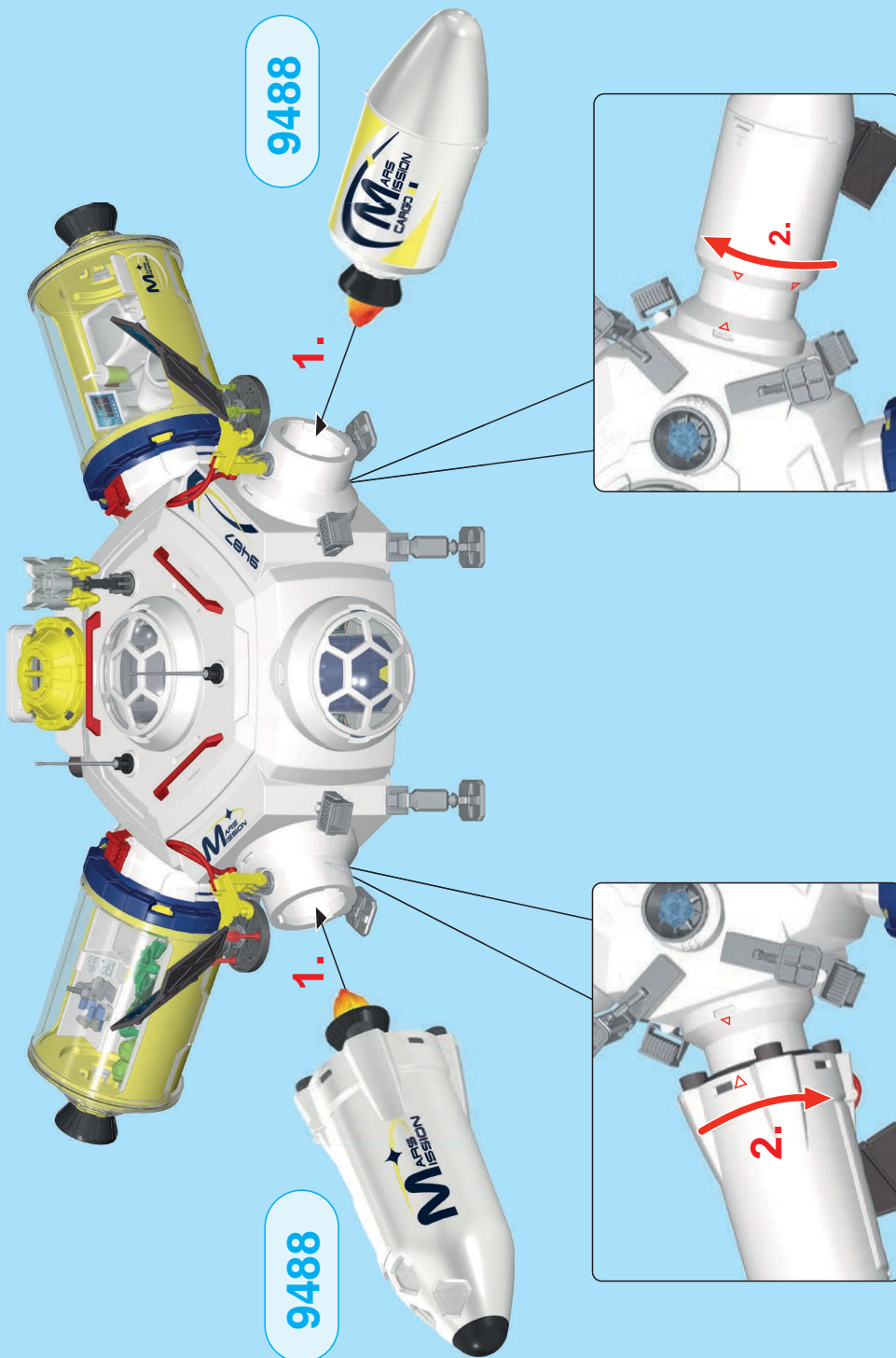

US

NOTE: This equipment has been tested and found to comply with the limits for a Class B digital device, pursuant to part 15 of the FCC Rules. These limits are designed to provide reasonable protection against harmful interference in a residential installation. This equipment generates, uses and can radiate radio frequency energy and, if not installed and used in accordance with the instructions, may cause harmful interference to radio communications. However, there is no guarantee that interference will not occur in a particular installation. If this equipment does cause harmful interference to radio or television reception, which can be determined by turning the equipment off and on, the user is encouraged to try to correct the interference by one or more of the following measures:

- Reorient or relocate the receiving antenna.
- Increase the separation between the equipment and receiver.
- Connect the equipment into an outlet on a circuit different from that to which the receiver is connected.
- Consult the dealer or an experienced radio/TV technician for help.

PLAYMOBIL USA, INC.

26 Commerce Drive
Cranbury, NJ 08512
Phone 1-800-752-9662 or 609-395-5566
Email: service@playmobilusa.com

Caution: Changes or modifications not expressly approved by the party responsible for compliance could void the user's authority to operate the equipment.

Serviceadressen finden Sie in allen PLAYMOBIL-Prospekten

Addresses of Customer Service Departments are shown in all PLAYMOBIL catalogues

L'adresse du service consommateurs est indiquée dans tous les catalogues PLAYMOBIL

Troverete gli indirizzi dei centri di assistenza in tutti i cataloghi PLAYMOBIL

In alle PLAYMOBIL catalogi vindt u het adres van onze klantendienst.

Las Direcciones de los Departamentos de Servicio al Consumidor se encuentran en todos los catálogos PLAYMOBIL

Η διεύθυνση του Γραφείου Εξυπηρέτησης Καταναλωτών PLAYMOBIL βρίσκεται σε όλους τους καταλόγους PLAYMOBIL.

pronounced: plāy-mō-bēēl

US

This device complies with Part 15 of the FCC Rules. Operation is subject to the following two conditions:

- (1) This device may not cause harmful interference, and
- (2) this device must accept any interference received, including interference that may cause undesired operation.

CA CAN ICES-3 (B)/NMB-3(B)

Cet équipement est conforme à la Section 15 des règlements de la FCC. Son fonctionnement est soumis aux deux conditions suivantes:

- (1) Cet équipement ne peut causer d'interférence nuisible, et
- (2) cet équipement doit pouvoir fonctionner même s'il capte de l'interférence, incluant celle pouvant provoquer un fonctionnement indésirable.

Abbildungen können vom Original abweichen. / Product may differ from image shown. / Les illustrations peuvent différer de l'original. / Afbeeldingen kunnen verschillen van het werkelijke artikel.

© 2018 geobra Brandstätter Stiftung & Co.KG

Brandstätterstr. 2-10

90513 Zirndorf, Germany.

No. 30 82 3066 07.23



Adresses sur quefairemesdecheets.fr