

playmobil®

9340



WARNING:
CHOKING HAZARD

Small parts. Not for children under 3 years.

"Ne concerne que les USA"

Wichtige Unterlagen, bitte sorgfältig aufbewahren!
Important: Please keep these instructions for future reference!
Documents importants, à conserver soigneusement!
Belangrijke documenten, bewaar deze zorgvuldig!



1

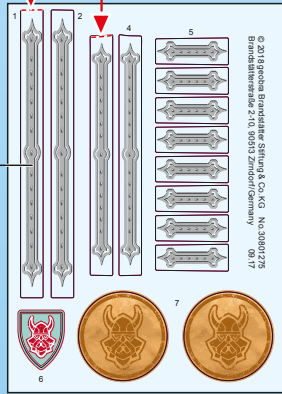
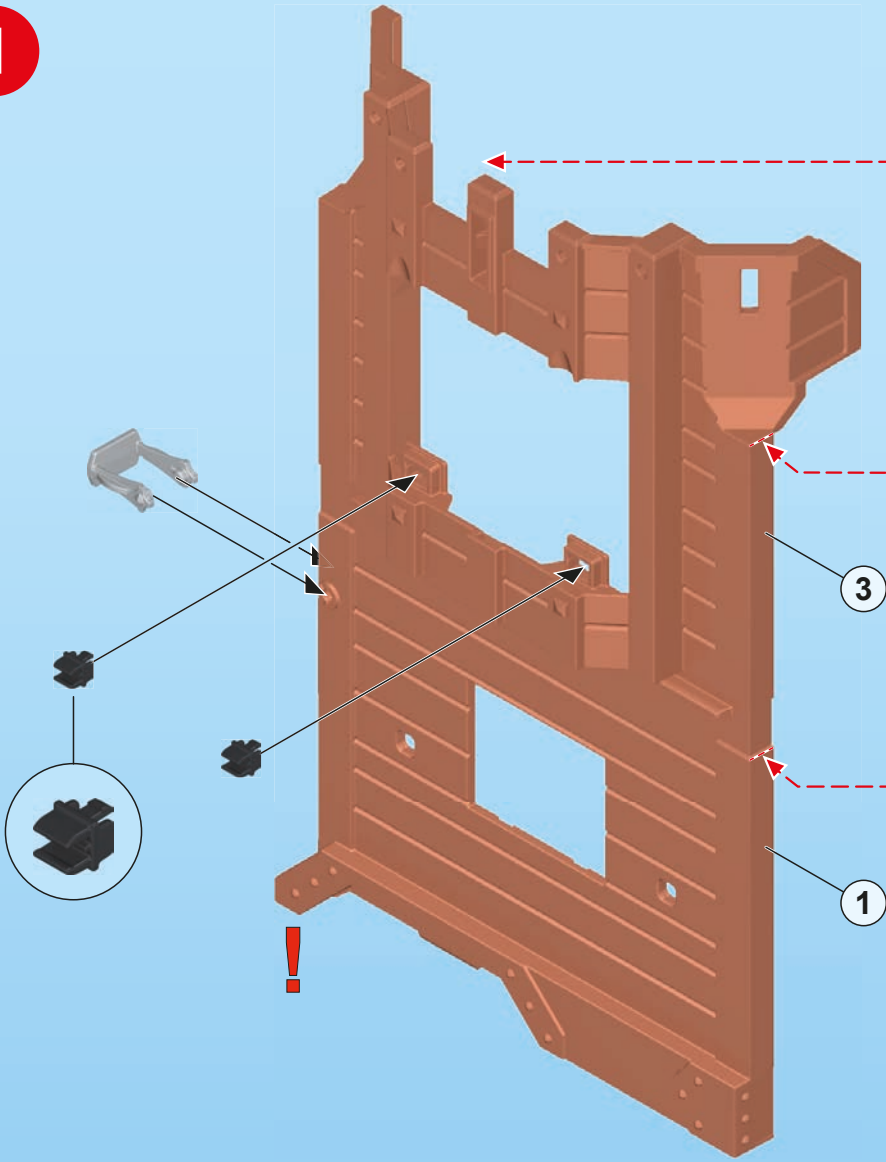

2

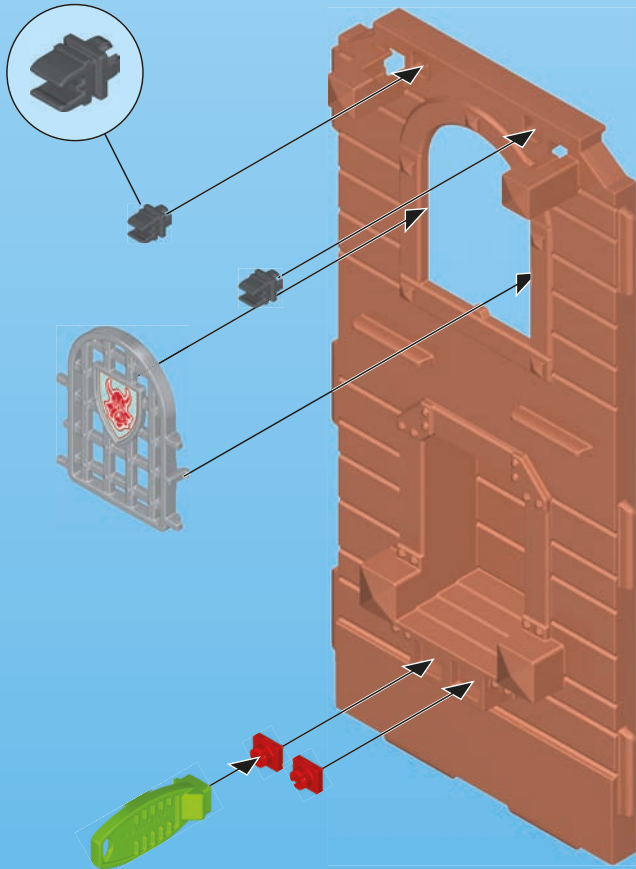
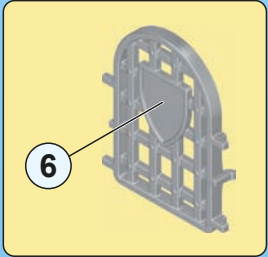

3

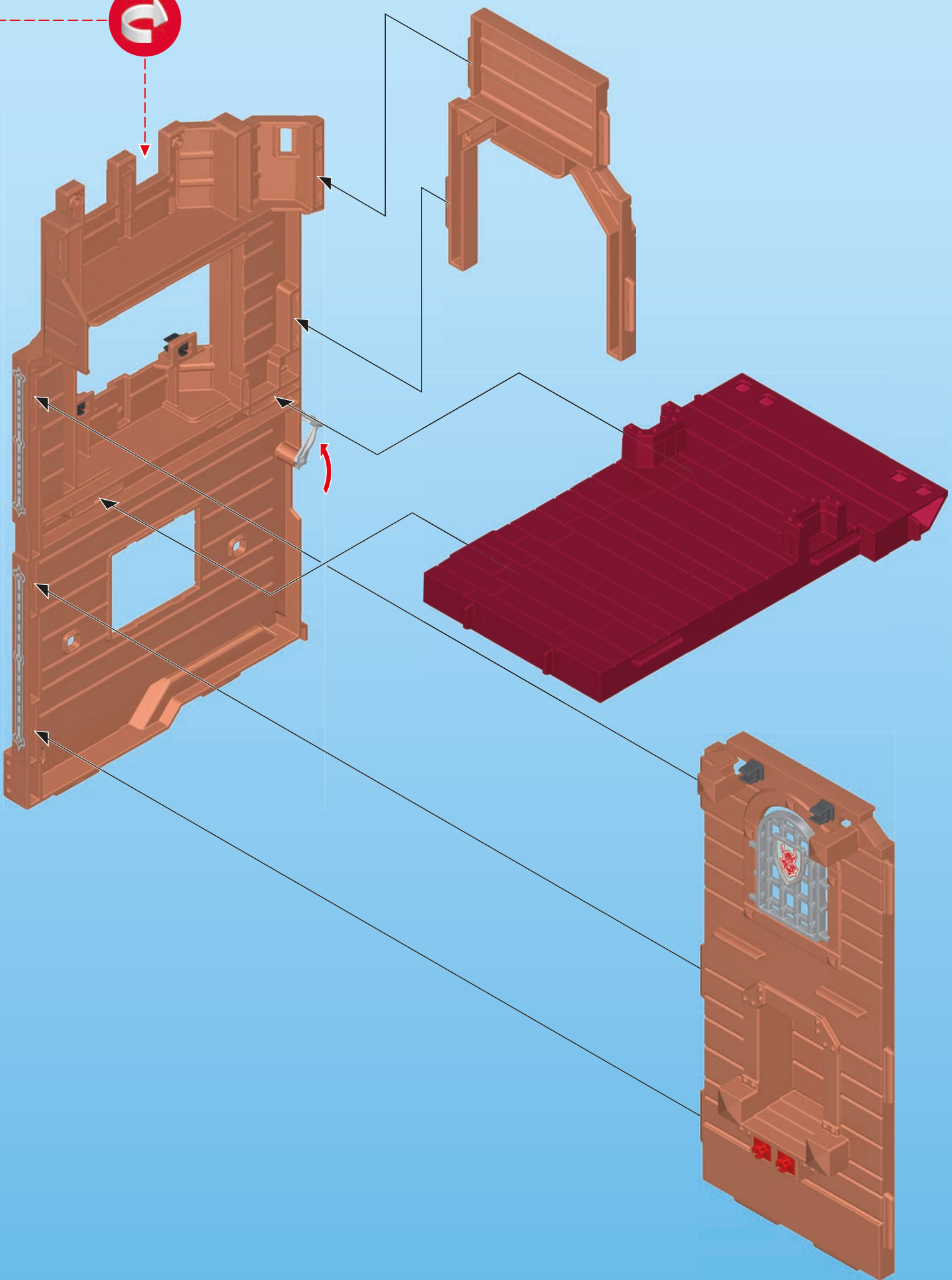

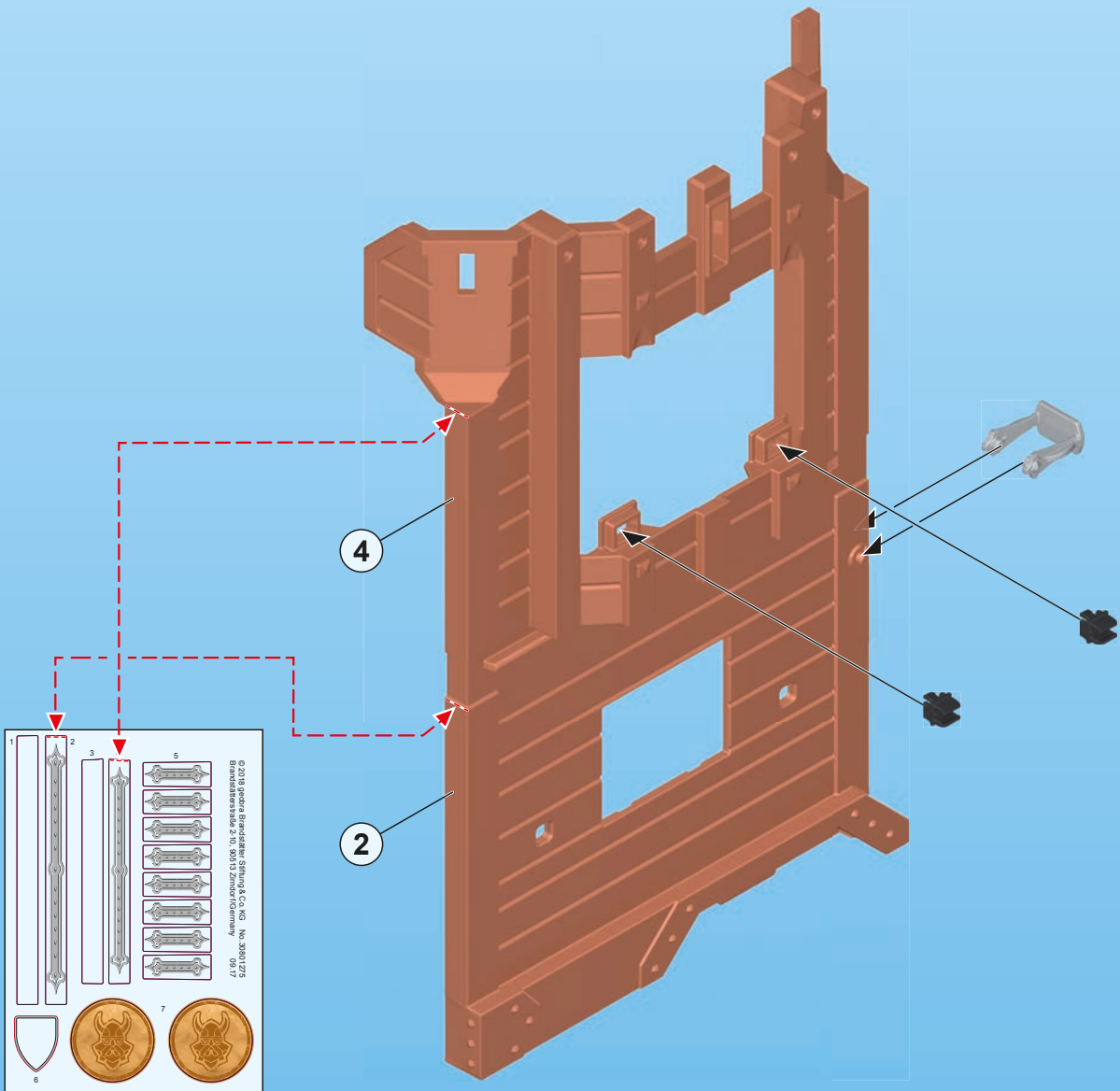

5

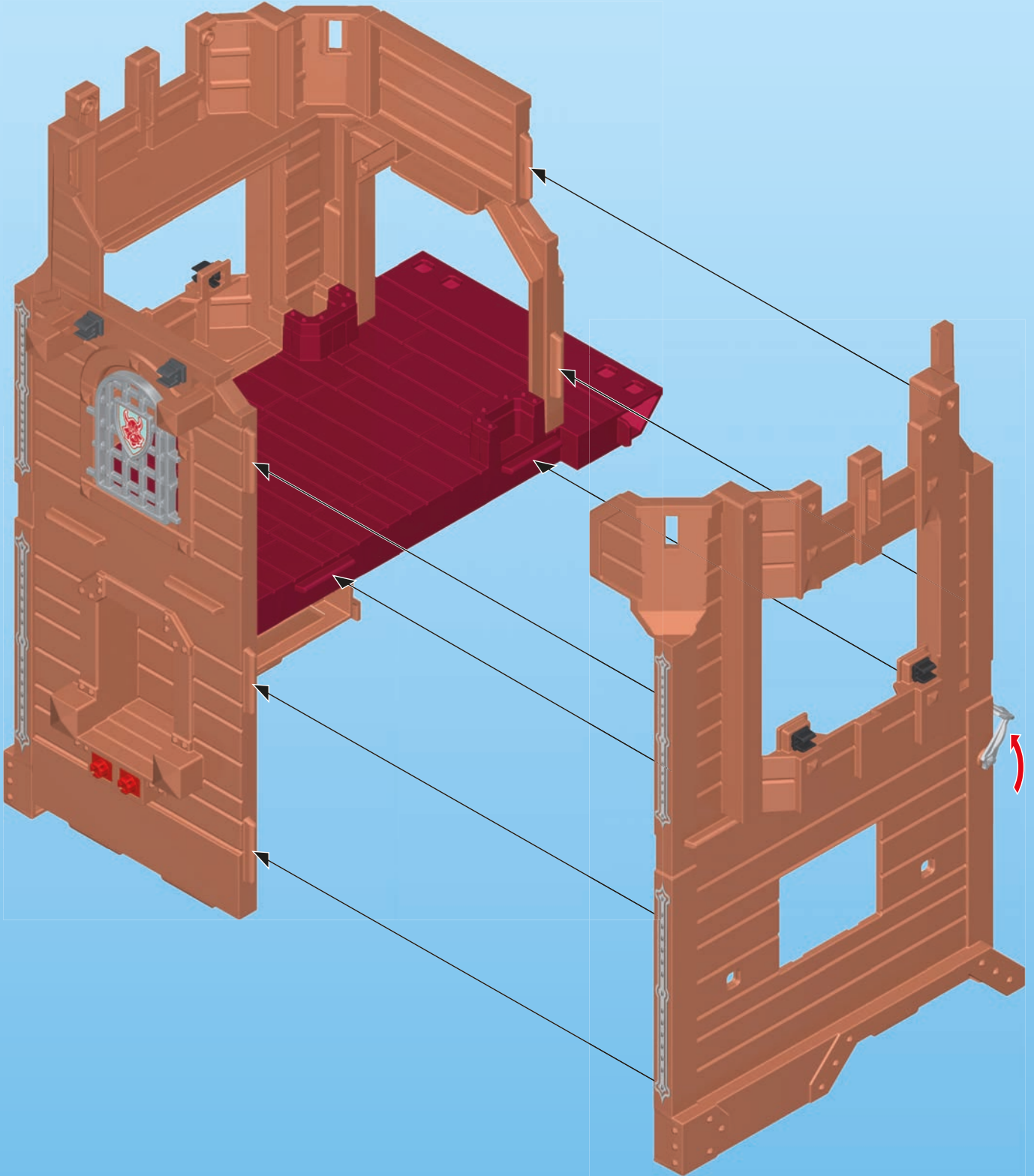

6

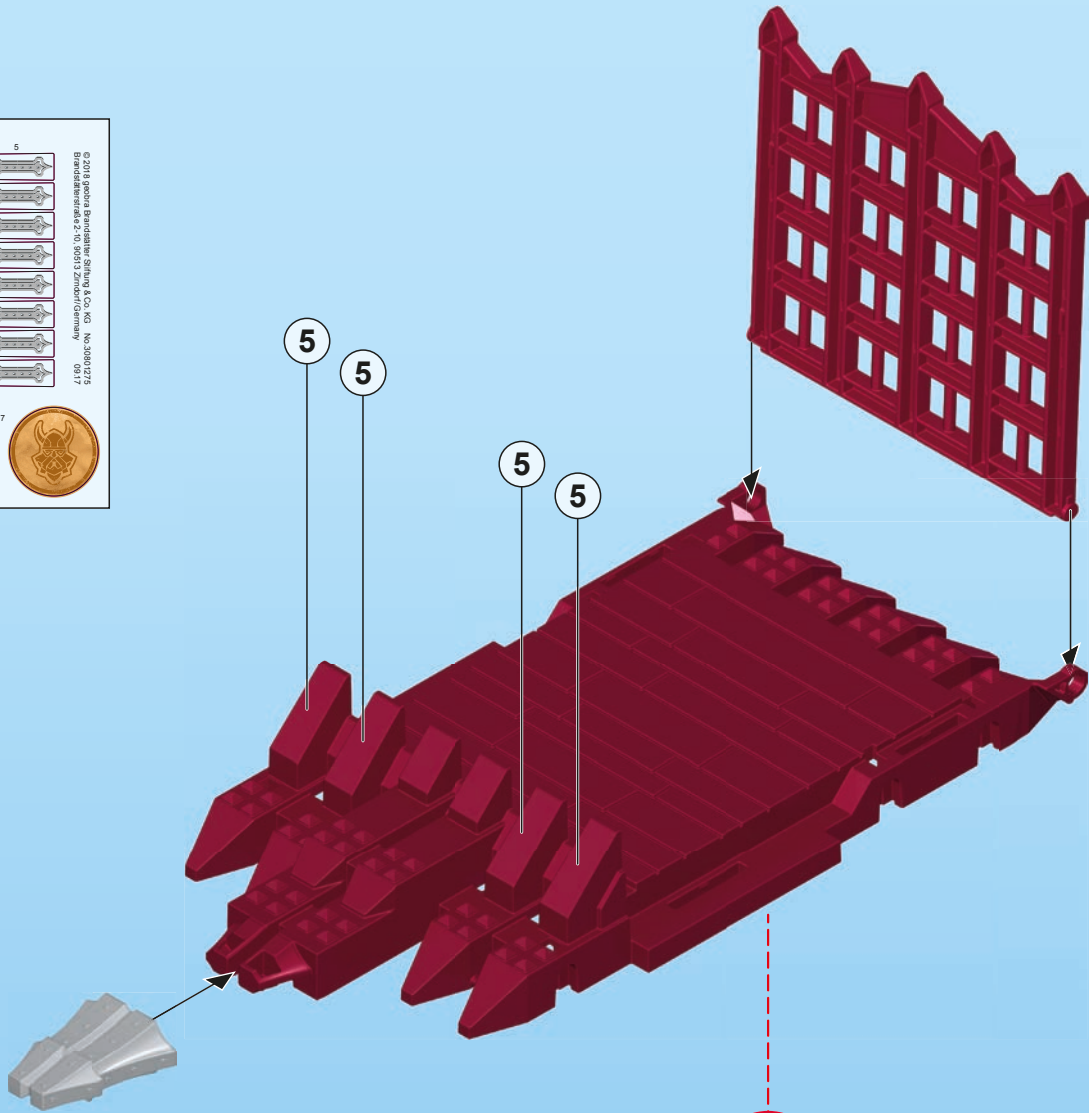
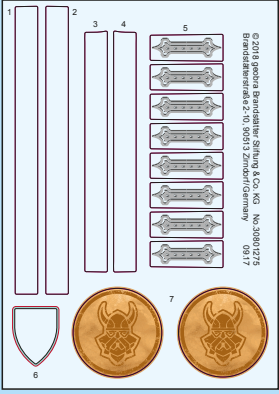

7

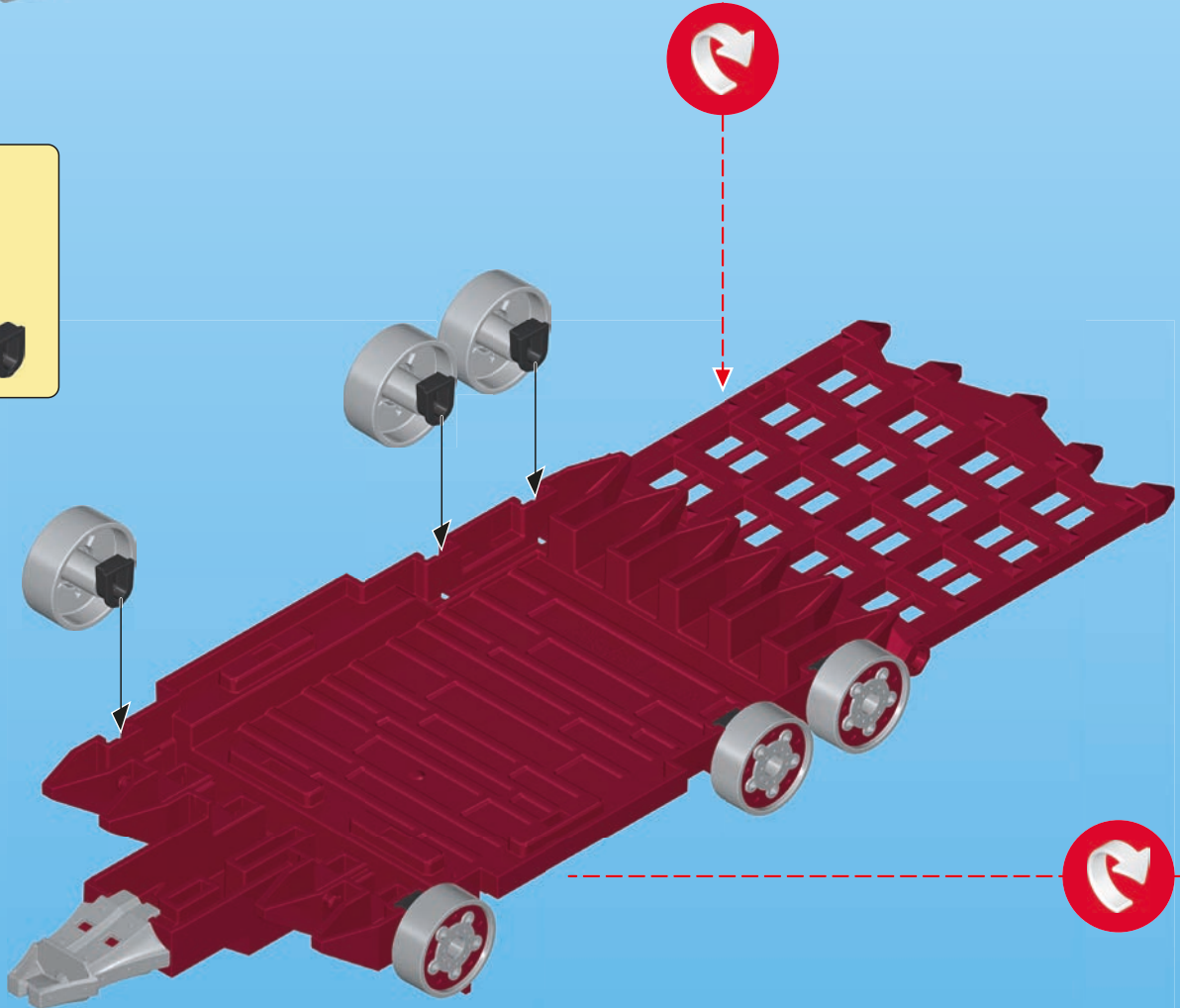
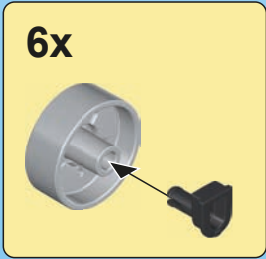

8

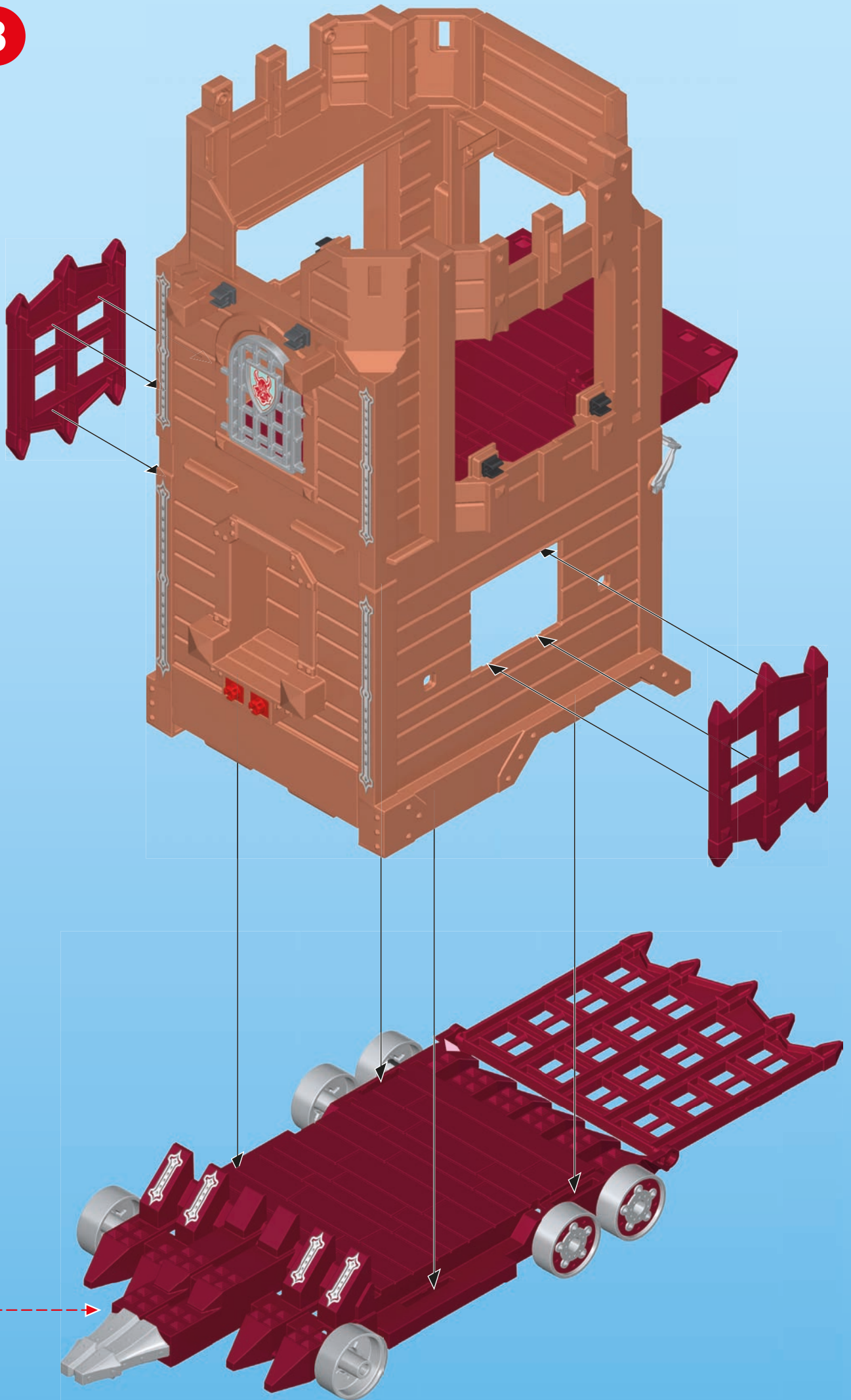

9

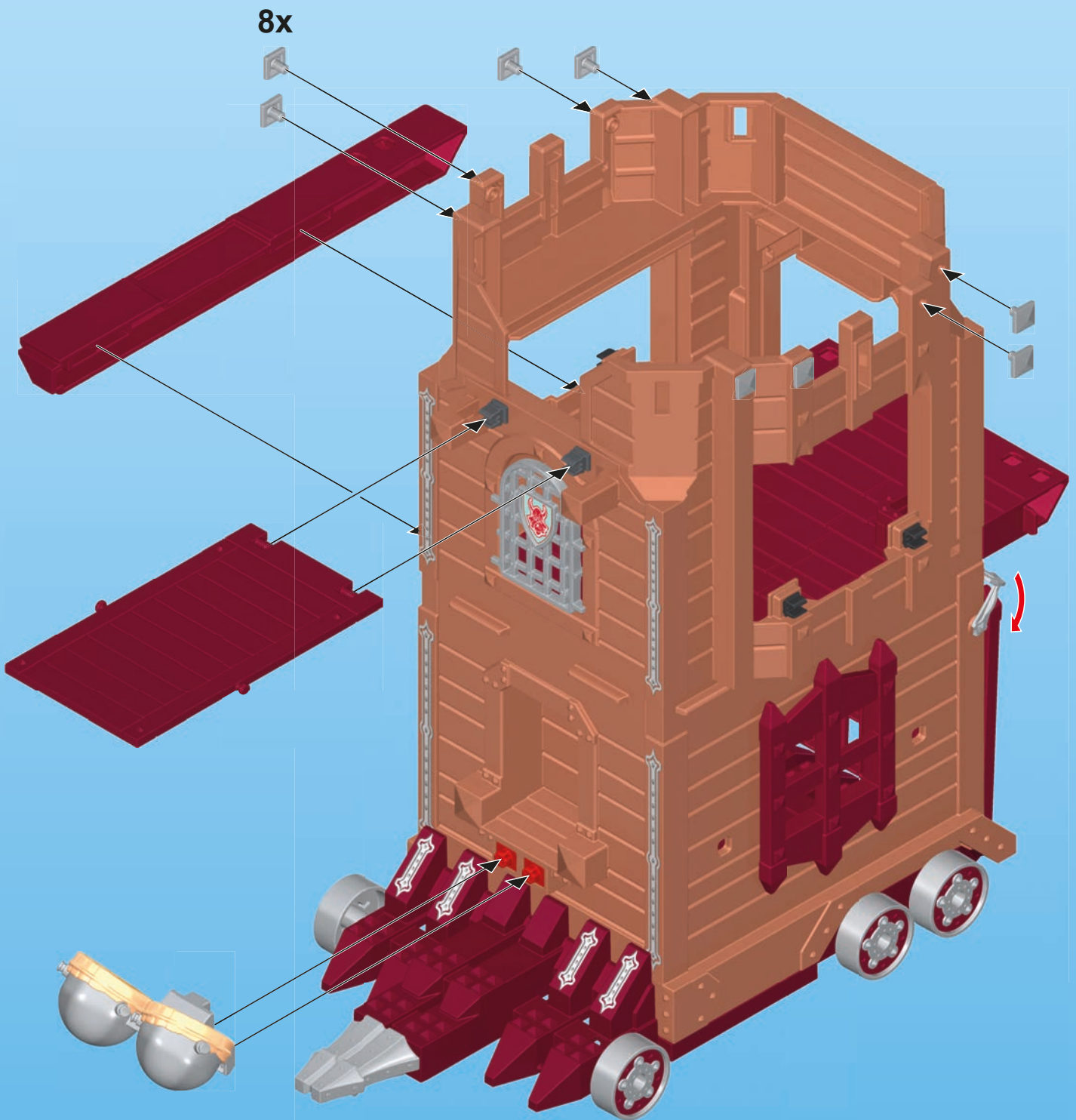
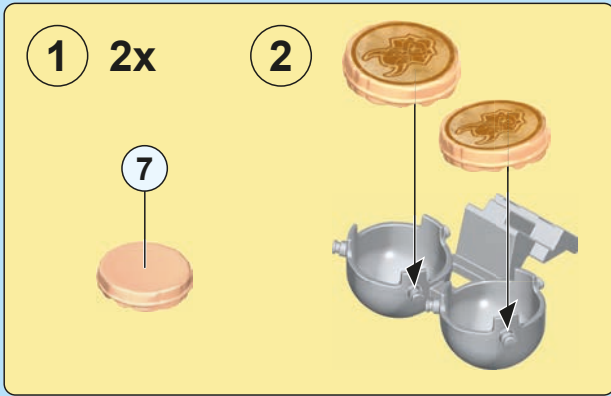
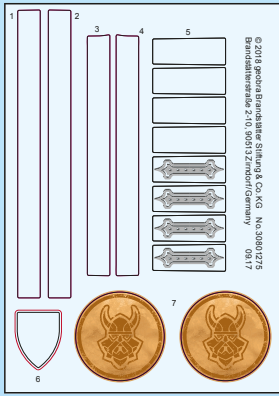

10

4x

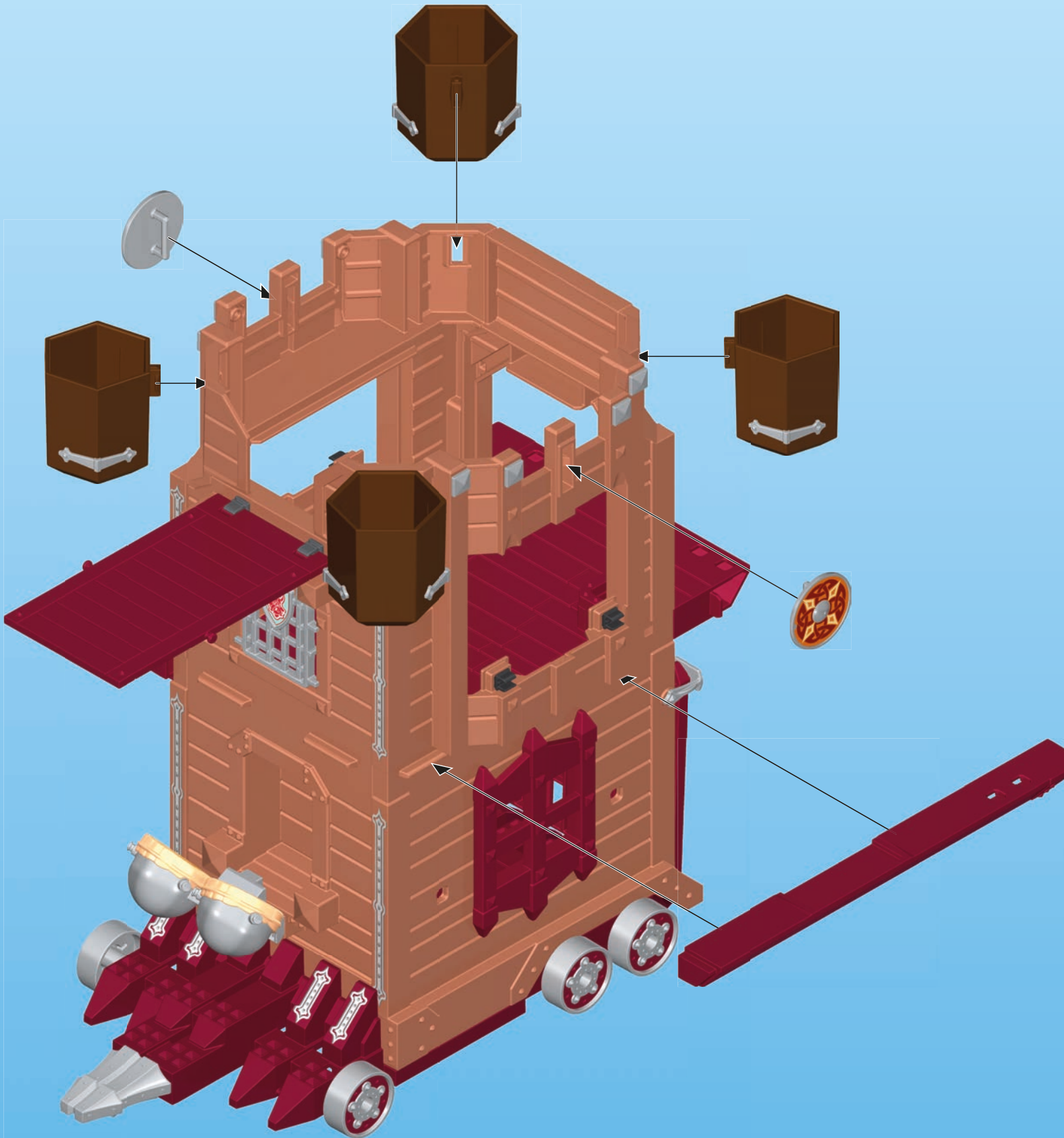
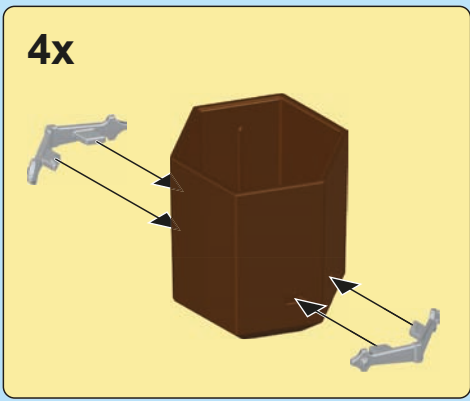

2x

1

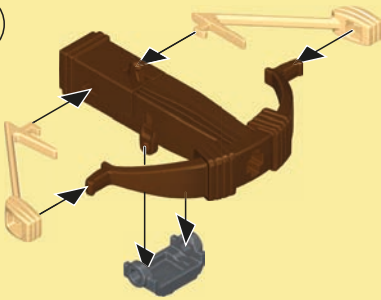

2

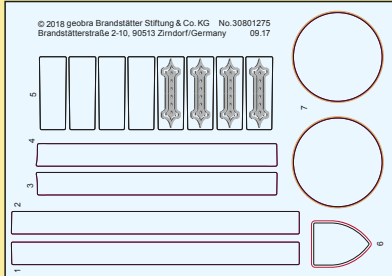

5

5

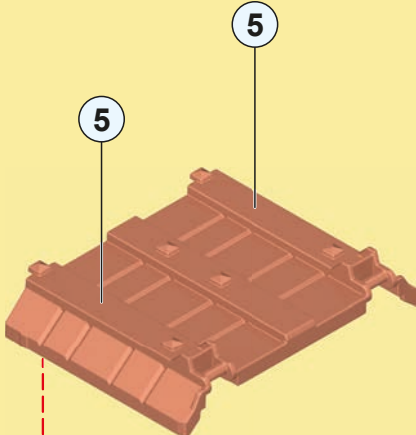

3

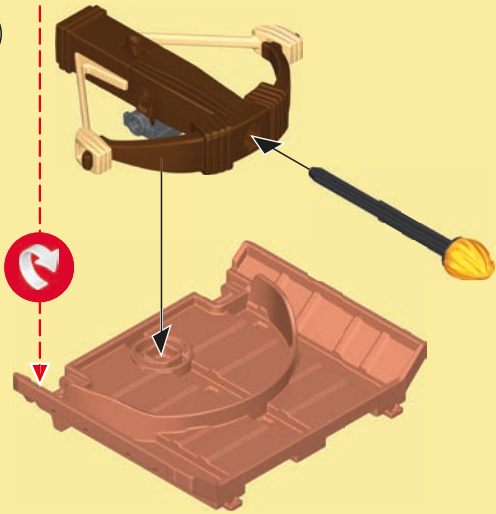

D A CH L B **ACHTUNG!** Nur mitgelieferte PLAYMOBIL Geschosse verwenden. Nicht auf Augen oder Gesicht zielen.

USA GB CDN M IRL **WARNING!** Only use the PLAYMOBIL projectiles supplied. Do not aim at eyes or face.

F CDN B L CH **ATTENTION!** Seulement utiliser les projectiles PLAYMOBIL fournis. Ne pas viser les yeux ou le visage.

E (MEX) i **ADVERTENCIA!** Utiliza únicamente los proyectiles PLAYMOBIL suministrados. No apuntar a los ojos ni a la cara.

NL B **WAARSCHUWING!** Uitsluitend meegeleverde PLAYMOBIL delen gebruiken. Niet op ogen of gezicht richten.

I CH **AVVERTENZA!** Usare soltanto i proiettili PLAYMOBIL in dotazione. Non mirare agli occhi o al viso.

P **ATENÇÃO!** Usar apenas os projéteis PLAYMOBIL juntamente fornecidos. Não apontar para os olhos ou face.

DK **ADVARSEL!** Anvend kun de medfølgende PLAYMOBIL projektiler. Sigt ikke mod øjne eller ansigt.

N **ADVARSEL!** Benytt kun PLAYMOBIL projektil som leveres med. Sikt ikke på ansikt eller øyne.

S FIN **WARNING!** Använd endast medlevererade PLAYMOBIL-skott. Ei saa kohdistaa suoraan silmiin tai kasvoihin.

FIN **VAROITUS!** Käytä vain mukana toimitettuja PLAYMOBIL-ammuksia. Älä tähtää päin silmiä tai kasvoja.

H **FIGYELMEZTETÉS.** Csak a csomagban található PLAYMOBIL lövedékeket szabad használni. Tilos szemre vagy arcra célozni.

CZ **UPOZORNĚNÍ!** Používejte pouze střely PLAYMOBIL, které jsou součástí dodávky. Nemiřte na oči nebo na obličej!

EST **HOIATUS!** Kasutage ainult kaasaantud PLAYMOBIL'i laskemoona. Ära sihi silmadesse ega näkku.

LV **BRIDINĀJUMS!** Izmantot tikai PLAYMOBIL piegādes komplektā iekļautos šāvņus. Nevērst pret acīm vai seju.

LT **ĮSPĖJIMAS!** Naudokite tik pridedamus PLAYMOBIL šaudmenis. Netaikyti į akis arba veidą.

SLO **OPOZORILO!** Uporabljajte le priložene PLAYMOBIL-ove kroglice. Ne merite v oči ali obraz.

SK **UPOZORNENIE!** Používajte len náboje dodávané spolu so sadou PLAYMOBIL. Nemierť do očí alebo do tváre.

PL **OSTRZEŻENIE!** Stosować tylko załączone PLAYMOBIL - kule / pociski. Nie celować w oczy i twarz.

TR CY **ΔΙΚΚΑΤ!** Sadece birlikte verilen PLAYMOBIL mermileri kullanınız. Göze veya yüze doğru tutmayınız.

GR CY **Προειδοποίηση!** Να χρησιμοποιούνται αποκλειστικά τα βλήματα της PLAYMOBIL που περιέχονται στη συσκευασία. Μη μην γίνεται στόχευση στα μάτια ή στο πρόσωπο.

RO **AVERTISMENT!** Se folosesc doar proiectilele incluse PLAYMOBIL. Nu se țintește în ochi sau în față.

BG **Внимание!** Използвайте само приложени PLAYMOBIL снаряди. Не насочвайте към очите и лицето.

HR **UPOZORENJE!** Upotrijebiti samo od strane PLAYMOBIL-a isporučene projekte. Ne ciljati u oči ili lice.

CN **警告!** 仅能用PLAYMOBIL的炮弹, 禁止瞄准眼睛或脸, 请勿瞄准眼睛或脸。
(说明书上含有重要信息, 请保留备用)

11

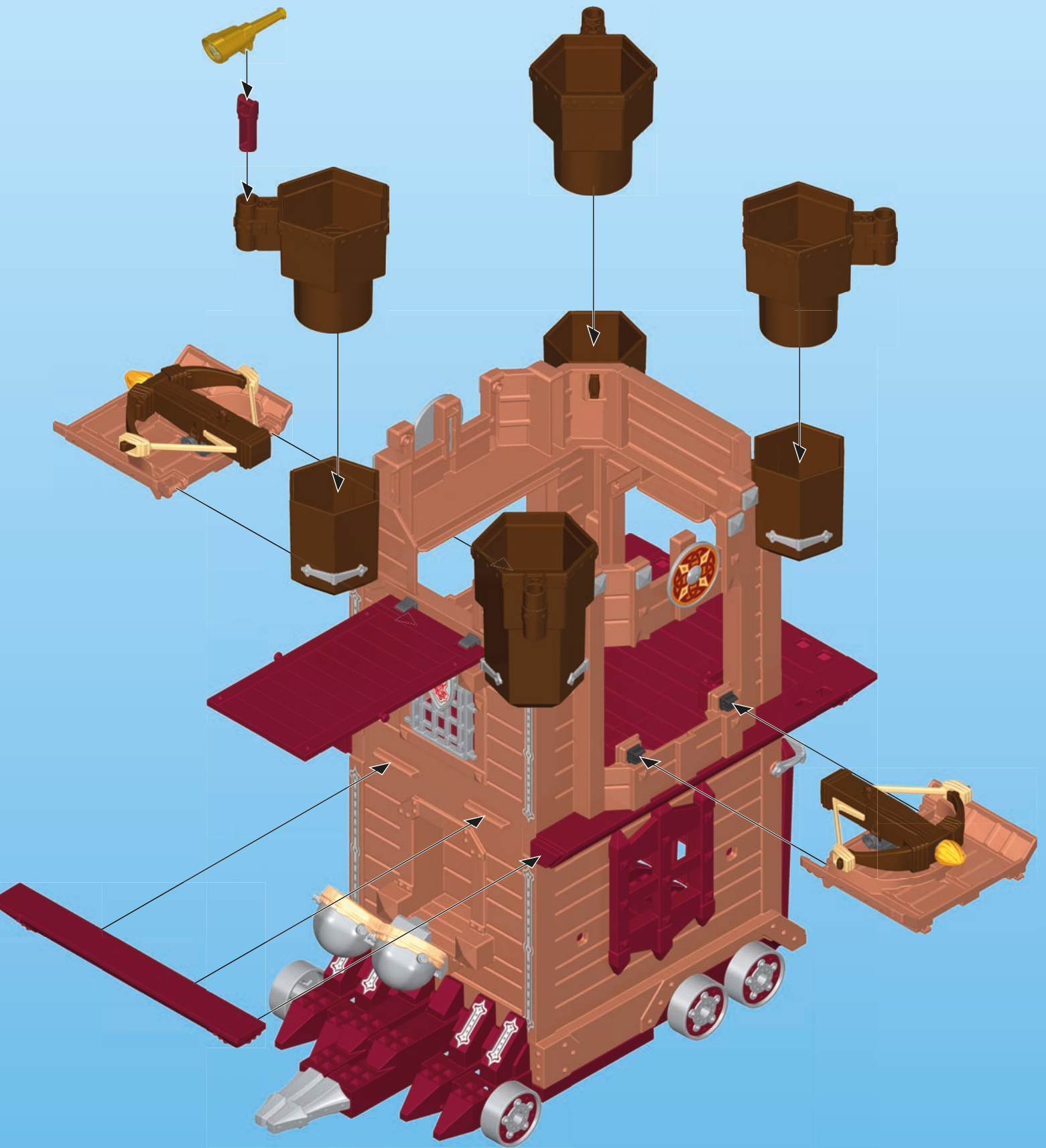

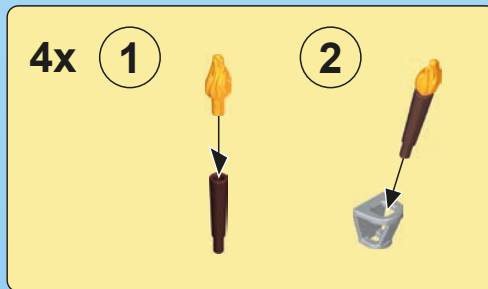
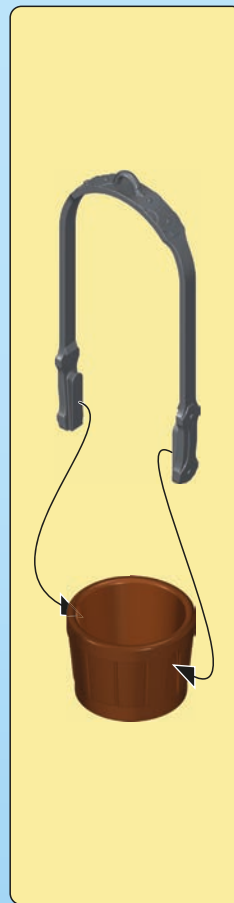
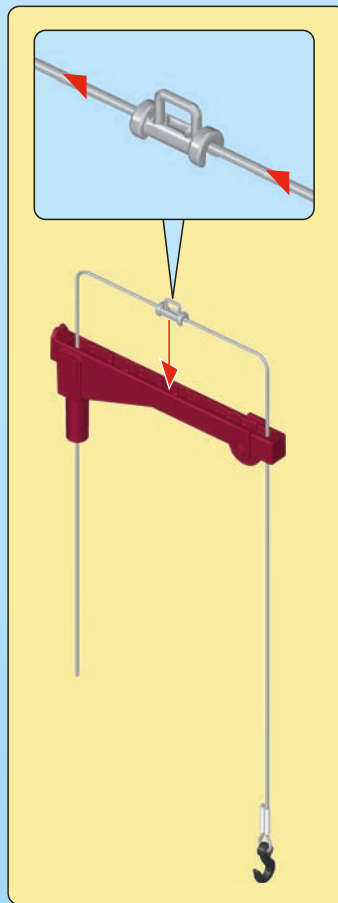
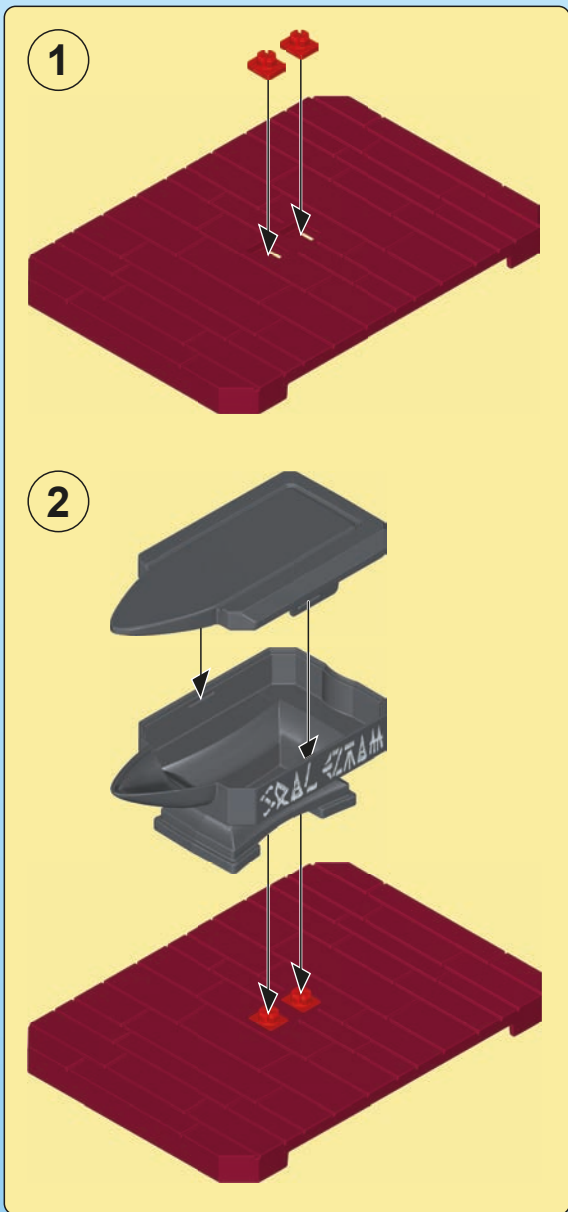

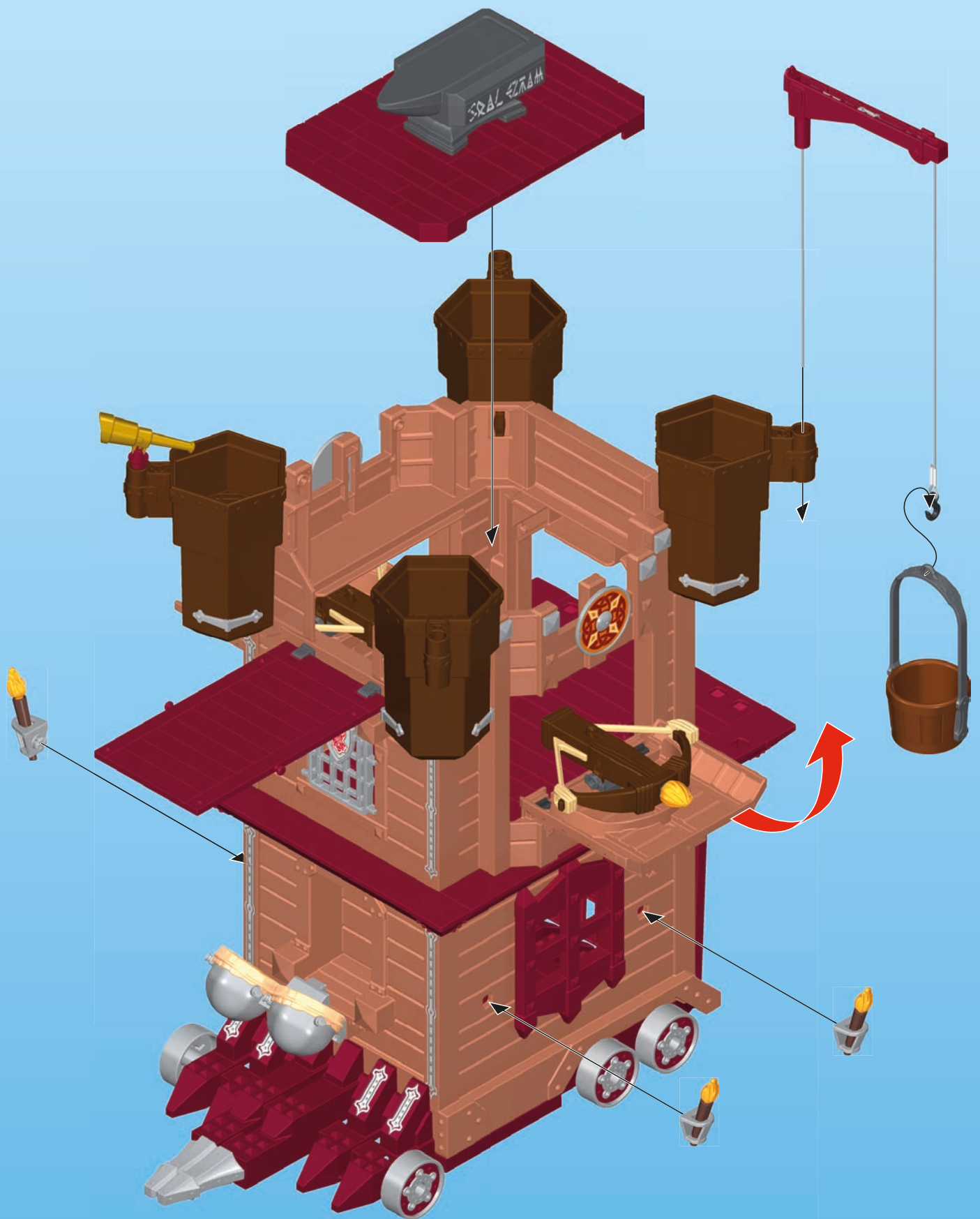

13

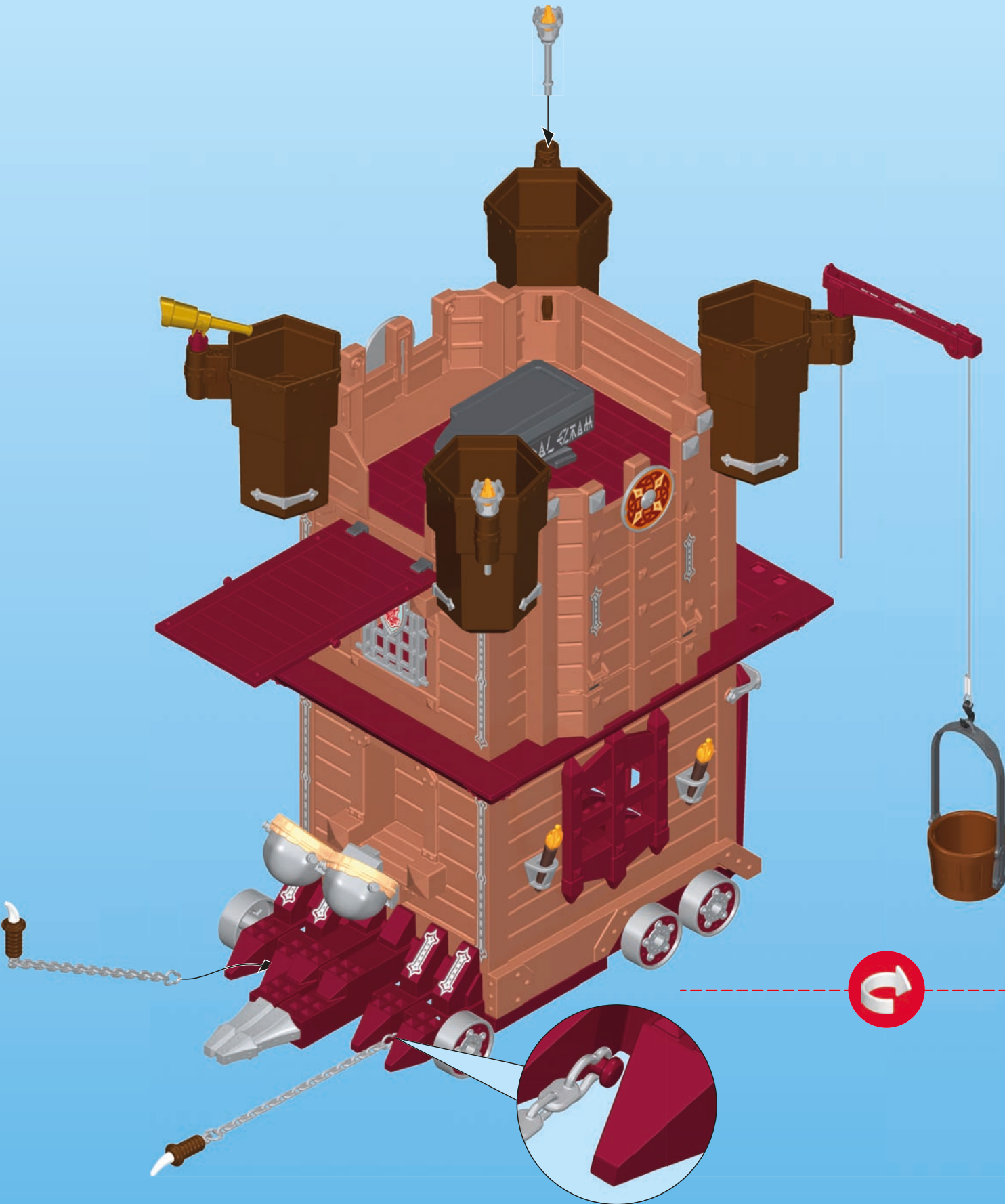
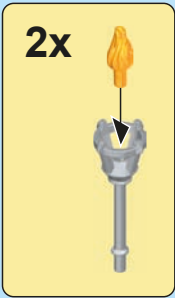
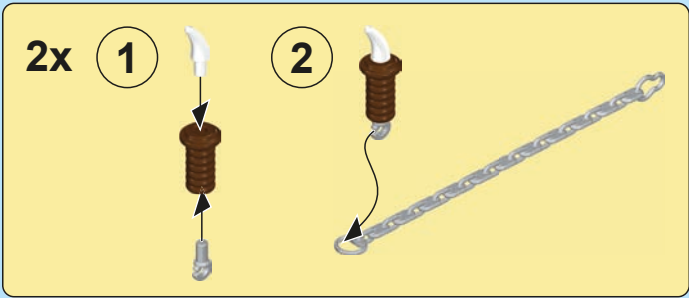

14

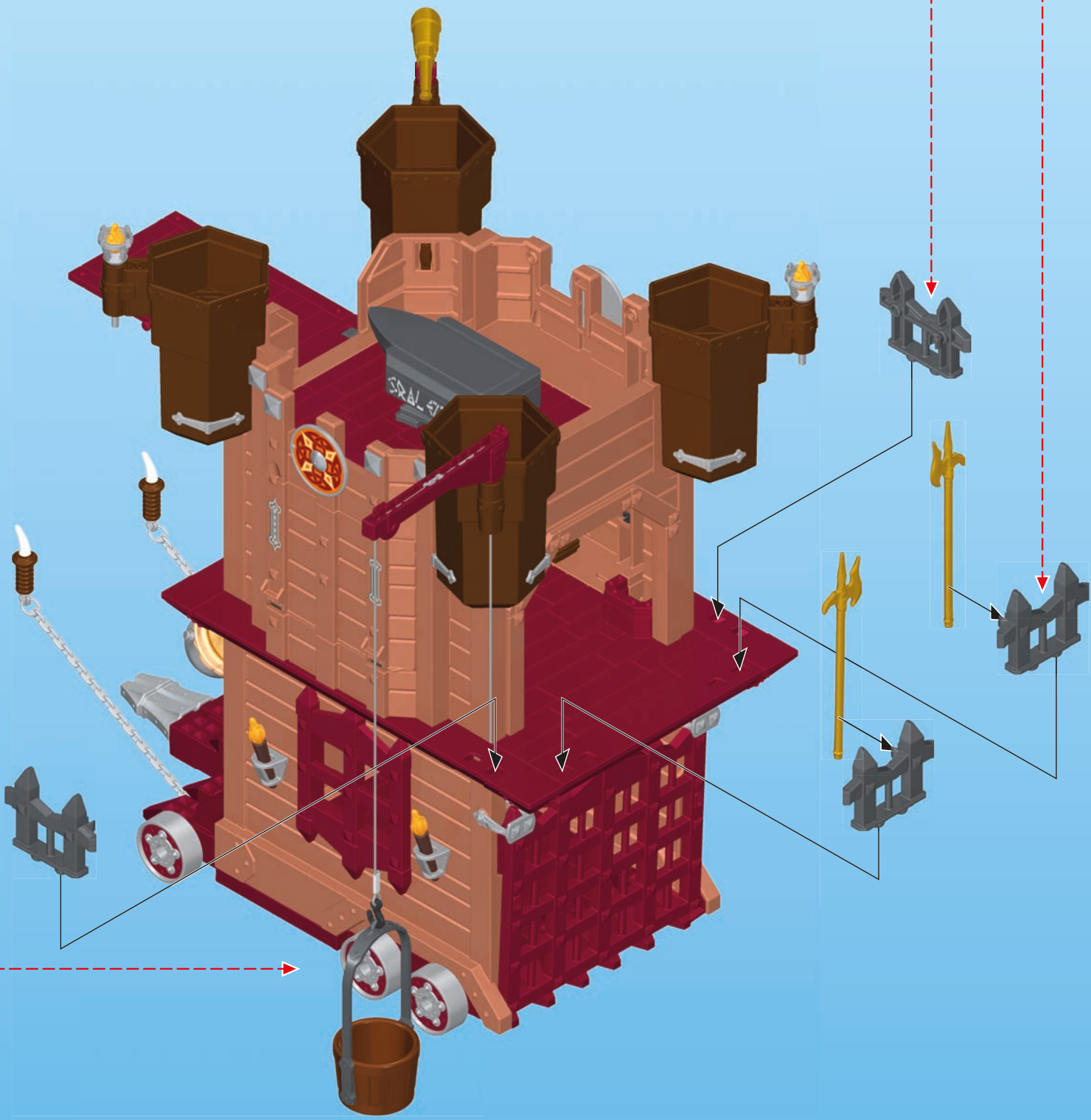
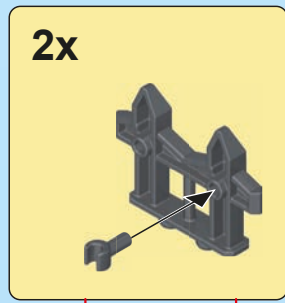
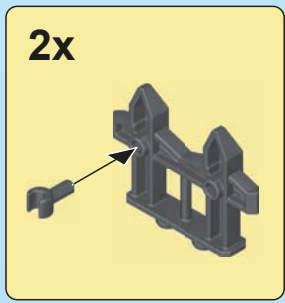

1

30 67 3163
30 02 7442

2

30 02 4400
30 67 3923

30 05 0040

30 23 6140
30 07 2602

30 07 2552

30 07 2562

30 02 6760

30 02 6750

30 07 2612

30 02 6650

1

30 80 1285

2

3

30 66 4680

30 07 2662

30 02 4410

30 20 6863

30 26 6250

30 21 1313

30 22 6302

30 13 1500

30 63 5575

30 07 2732

30 07 2542

30 06 9942

30 00 1614

30 07 2722

30 07 2762

30 00 1624

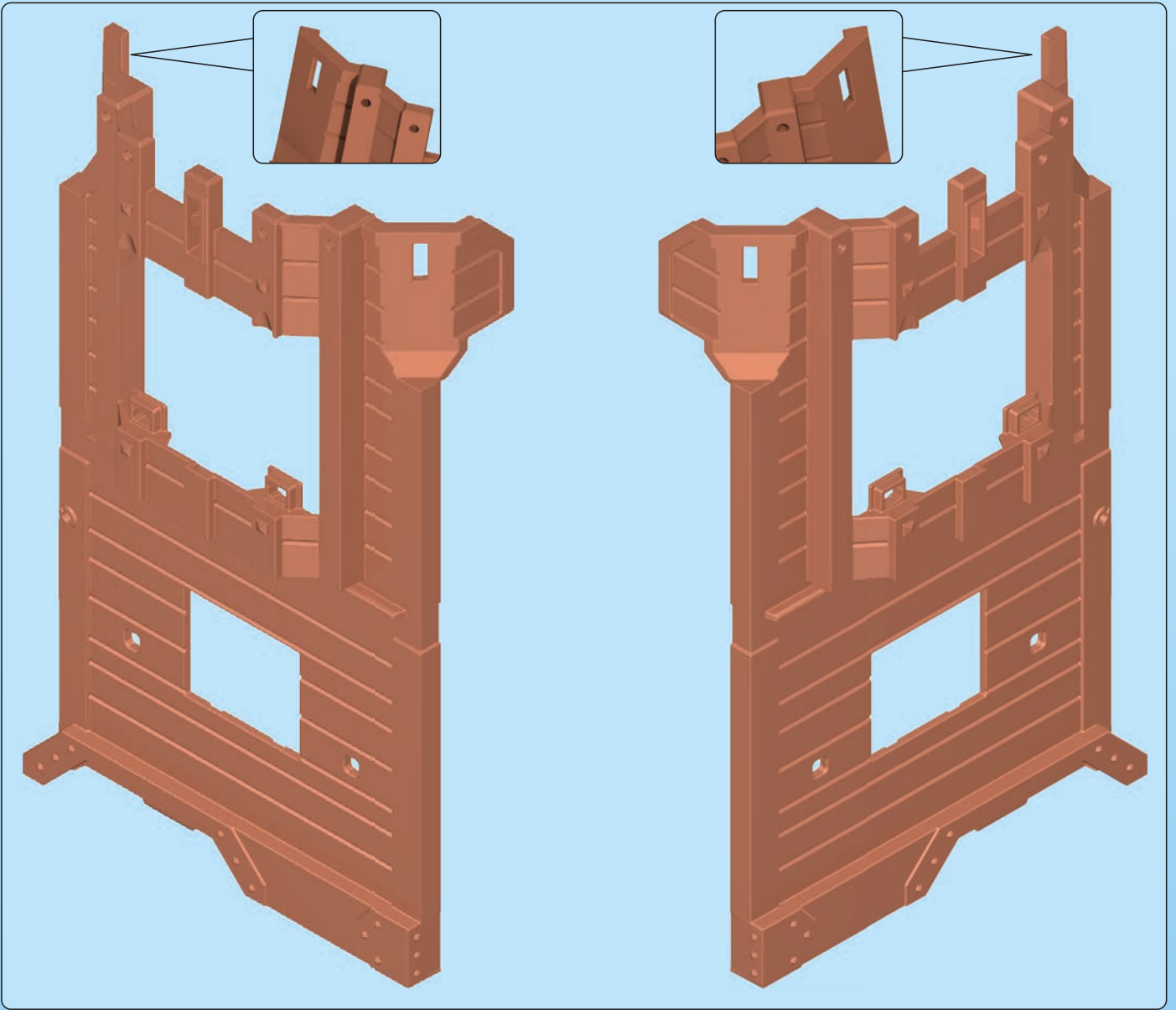

30 51 6532

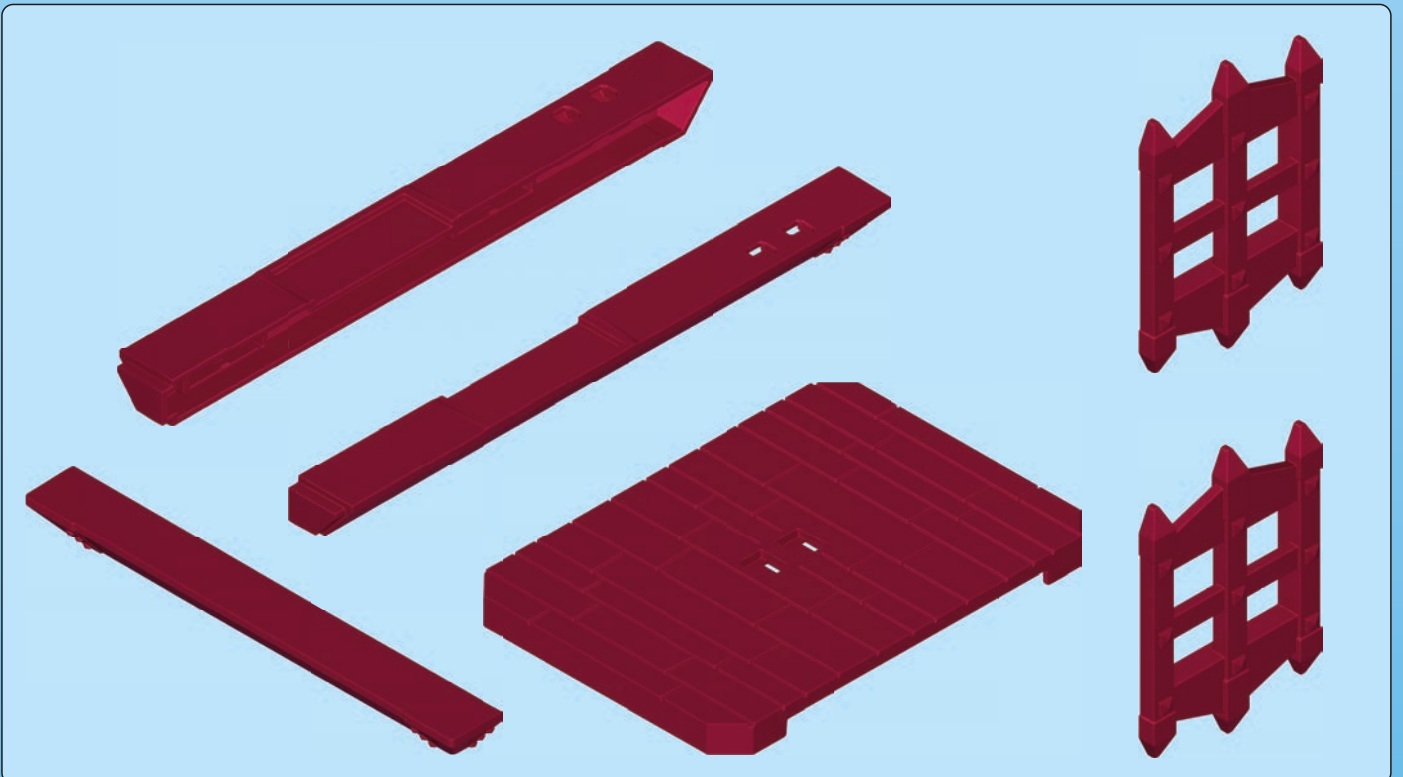

30 51 6542

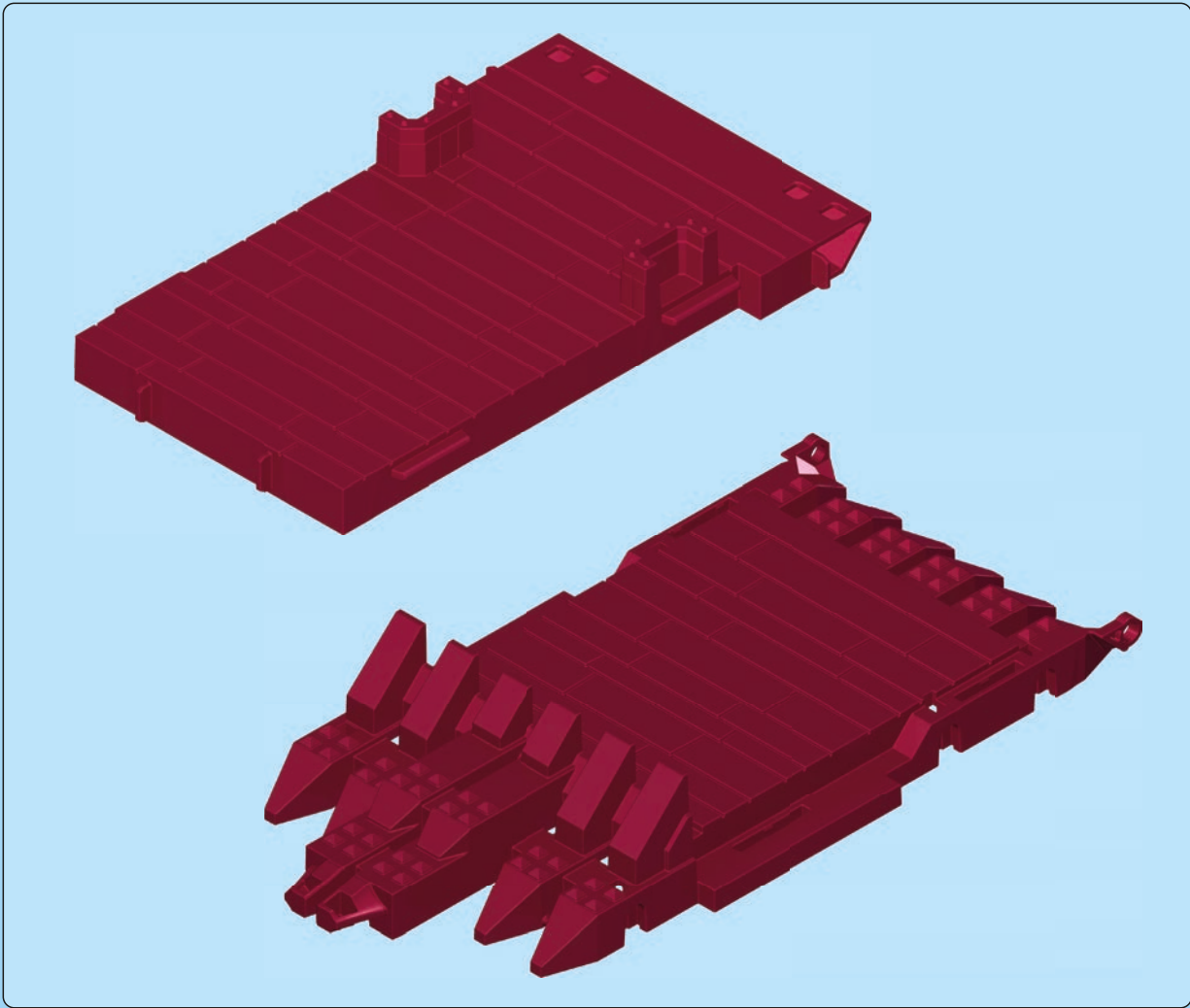

30 51 6522

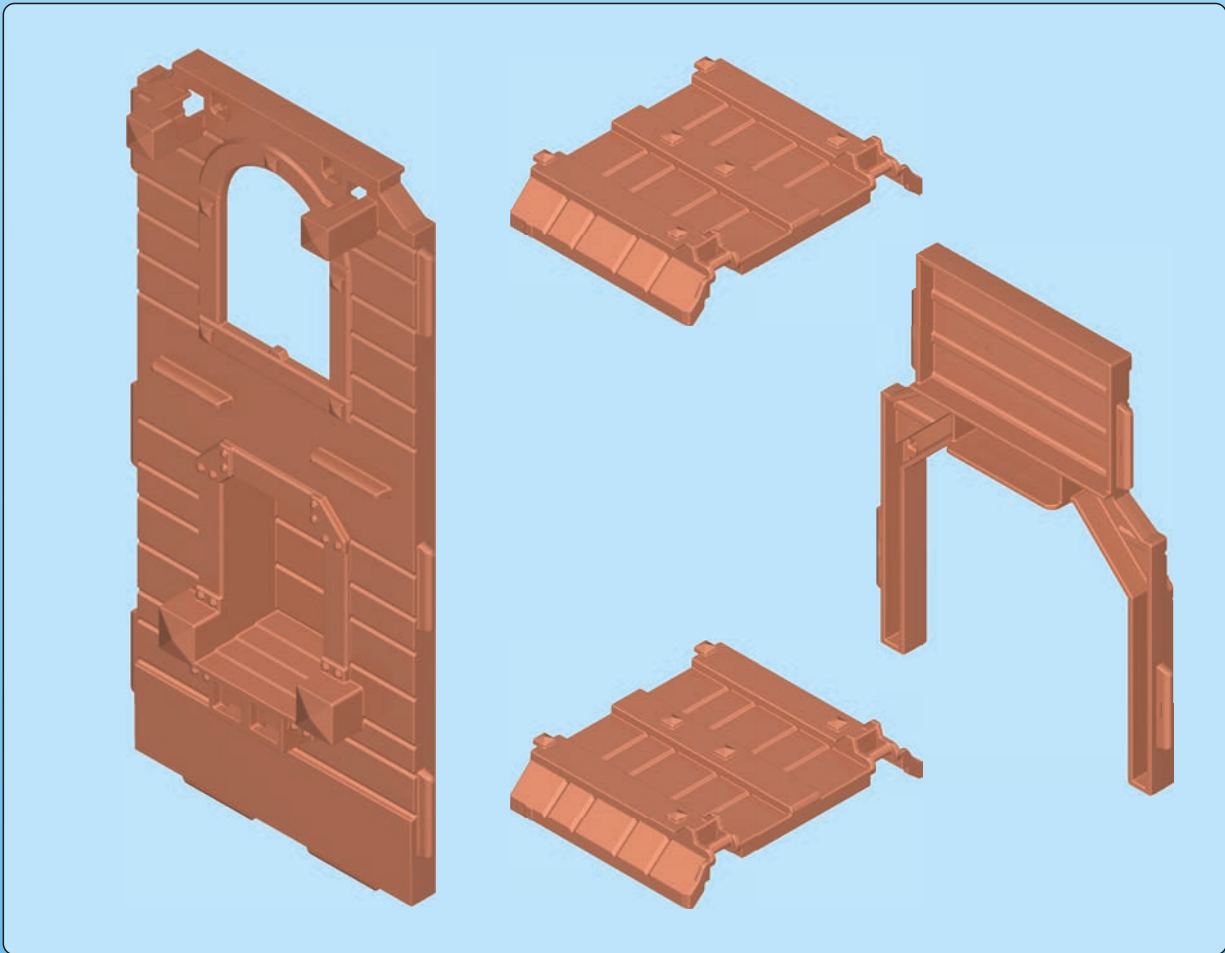

30 51 6512

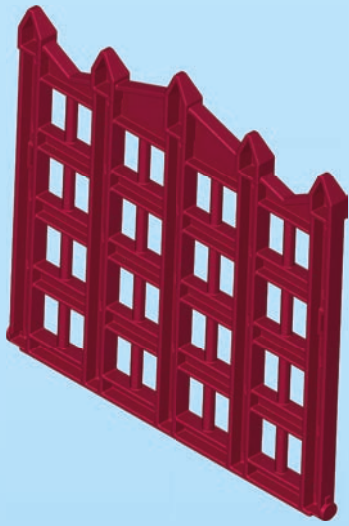

30 07 2882

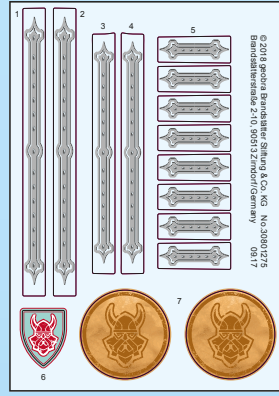

30 80 1275

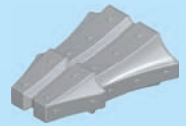

30 07 2842

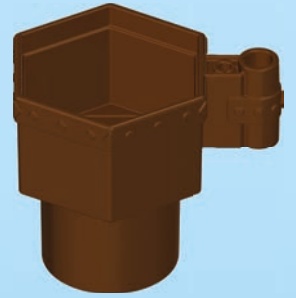

4x 30 08 3542

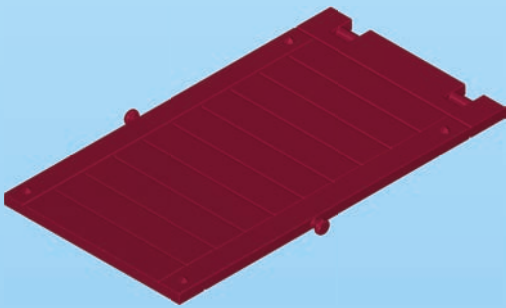

30 07 2872



30 07 6840



4x 30 08 3532



2x 30 22 7943

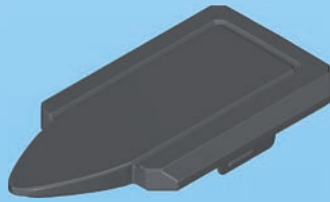

30 46 3522

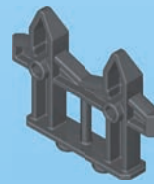

4x 30 07 2892



30 63 5645



30 27 2220



30 07 2902



2x 30 20 7033



30 82 6573



30 07 6830

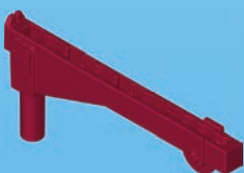

30 07 2712



2x 30 07 2512



2x 30 67 3473



2x 30 29 3940



30 22 7033



6x 30 20 3812



2x 30 63 5195



30 07 2652



2x 30 07 2862



30 20 0980



30 63 5555



30 63 5565



30 06 9832



30 07 2532



30 05 6790



4x 30 20 3952



2x 30 07 2622



30 07 2642



2x 30 07 2672



6x 30 26 5930



30 22 8890



4x 30 22 7752



2x 30 07 2592



2x 30 20 4560



30 07 2522



6x 30 23 0392



4x 30 22 4460



2x 30 07 2202



8x 30 07 2852



4x 30 03 6092

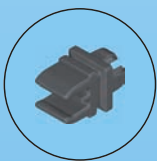

2x 30 20 9950

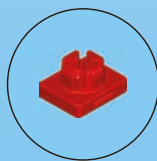

4x 30 09 6900



30 51 6492



4x 30 07 2632



30 23 7230

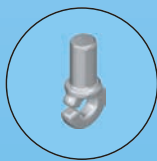

2x 30 02 7442

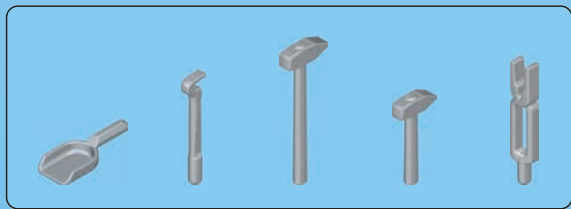

30 51 6462



30 28 8060



www.playmobil.com

© 2017 geobra Brandstätter Stiftung & Co.KG
Brandstätterstr. 2-10
90513 Zirndorf, Germany.
No. 30 80 1765 10.17

Abbildungen können vom Original abweichen. / Product may differ from image shown.
Les illustrations peuvent différer de l'original. / Afbeeldingen kunnen verschillen van het werkelijke artikel.

Serviceadressen finden Sie in allen Playmobil-Prospekten
Addresses of Customer Service Departments are shown in all Playmobil catalogues

L'adresse du service consommateurs est indiquée dans tous les catalogues Playmobil

Troverete gli indirizzi dei centri di assistenza in tutti i cataloghi Playmobil

In alle PLAYMOBIL catalogi vindt u het adres van onze klantendienst.

Las Direcciones de los Departamentos de Servicio al Consumidor se encuentran en todos los catálogos Playmobil

Η διεύθυνση του Γραφείου Εξυπηρέτησης Καταναλωτών PLAYMOBIL βρίσκεται σε όλους τους καταλόγους PLAYMOBIL.

pronounce: plāy-mō-bēel