

# playmobil®

## 9060



### WARNING: CHOKING HAZARD

Contains a small ball and small parts.  
Not for children under 3 years.

”Ne concerne que les USA“

Wichtige Unterlagen, bitte sorgfältig aufbewahren!  
Important: Please keep these instructions for future reference!  
Documents importants, à conserver soigneusement!  
Belangrijke documenten, bewaar deze zorgvuldig!



1

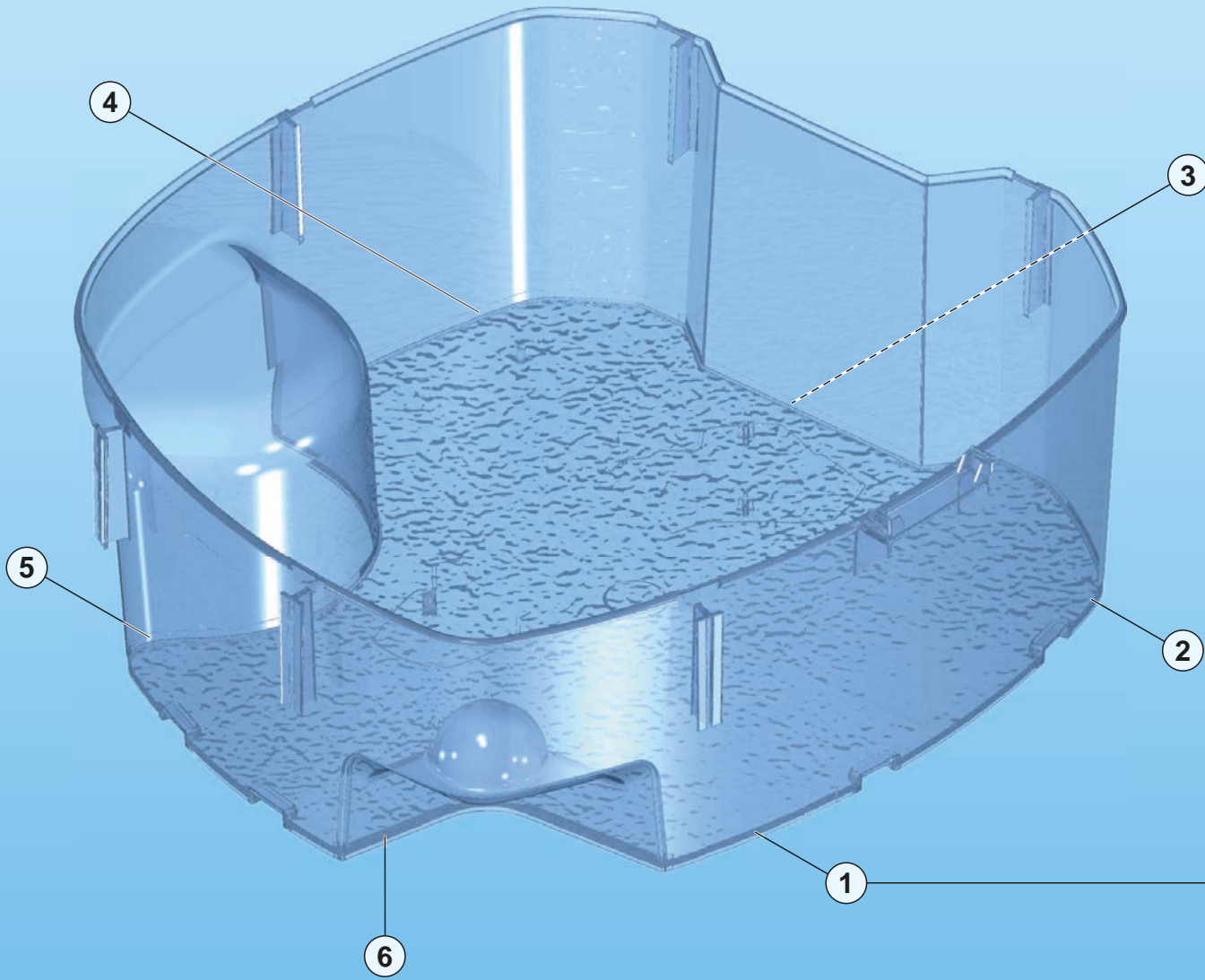

A sticker sheet for the aquarium, numbered 7 through 23. The stickers include: 7. Bird stickers; 8. Fish stickers; 9. Penguin sticker; 10. Fish sticker; 11. Penguin sticker; 12. Fish sticker; 13. Penguin sticker; 14. Fish sticker; 15. Penguin sticker; 16. Fish sticker; 17. Aquarium logo with a 360° rotation arrow; 18. Aquarium logo with a 'no' symbol; 19. Hazard symbol; 20. Bird sticker; 21. 'piscina' sign with a blue arrow; 22. Aquarium scene sticker; 23. Circular sticker with a clock face and a bird. Below the stickers are six yellow horizontal bars for labels, numbered 1 through 6, corresponding to the callouts in the 3D view.

© 2017 geobra Brandstätter Stiftung & Co. KG  
Brandstätterstraße 2-10 No.30801814  
90513 Zillndorf/Germany 10.16

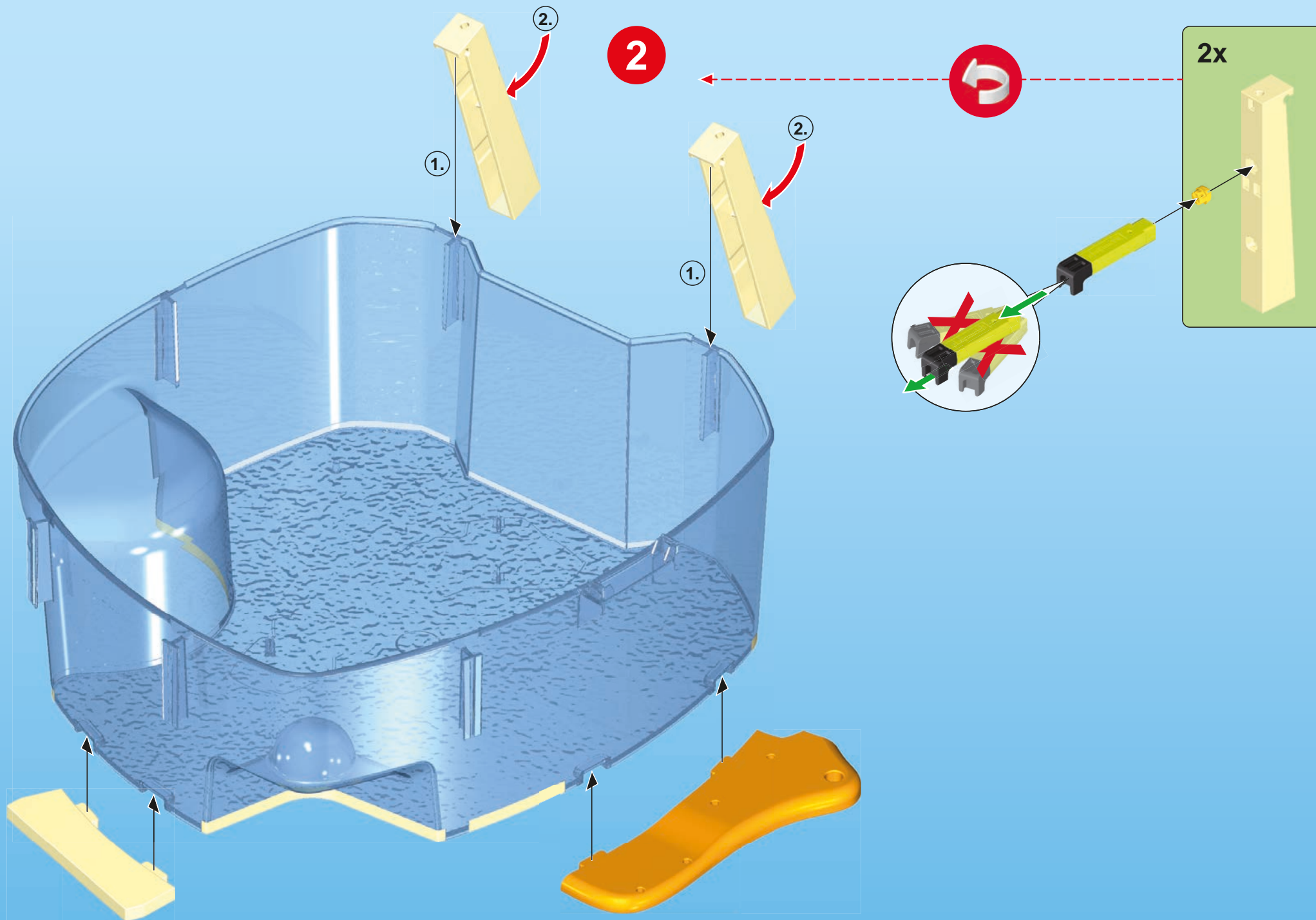

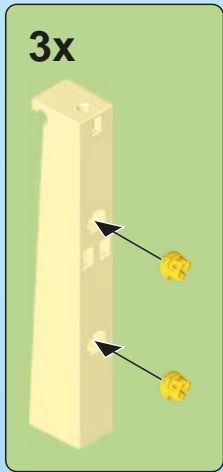

3

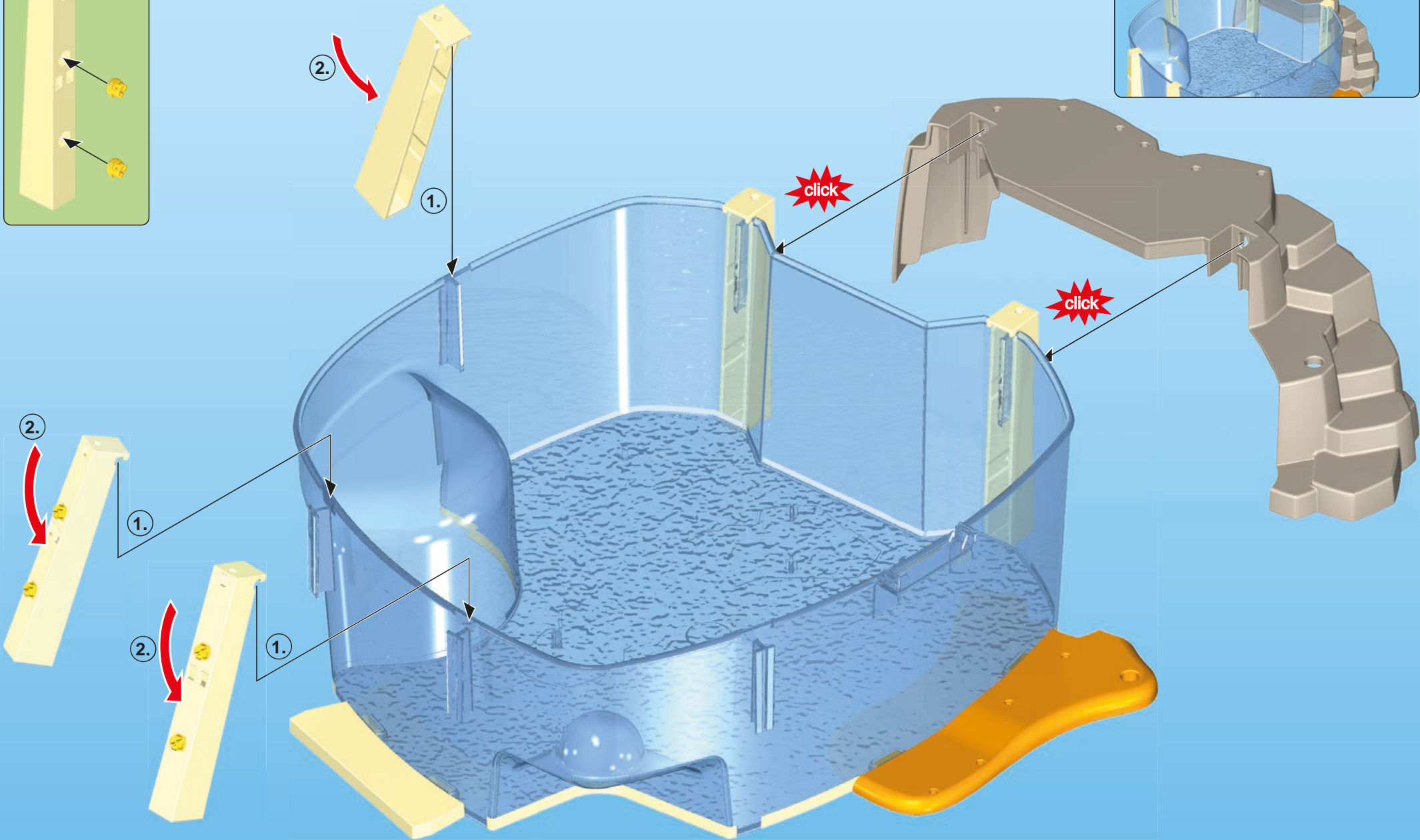
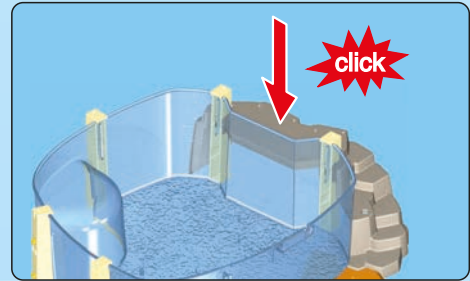

4

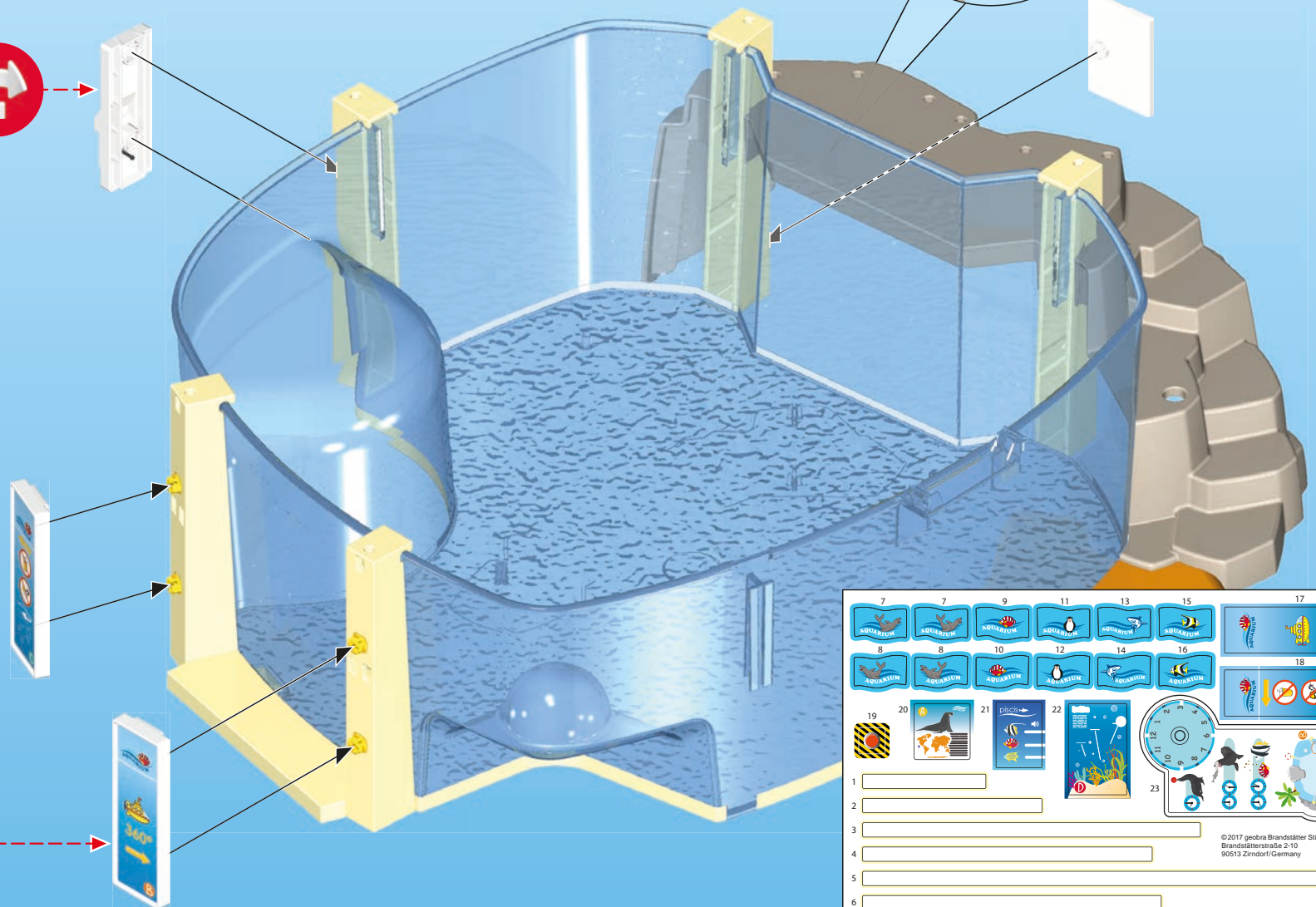
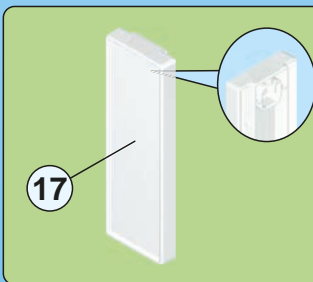
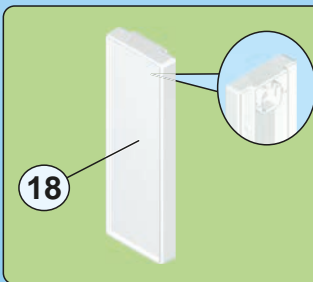
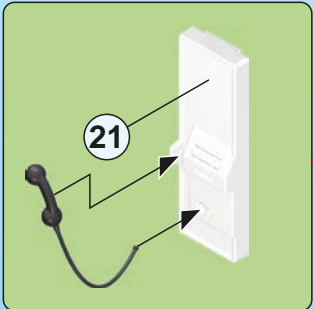
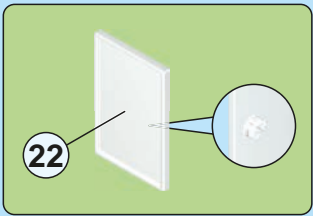

7	7	9	11	13	15	17
8	8	10	12	14	16	18
19	20	21	22	23		
1	<input type="text"/>					
2	<input type="text"/>					
3	<input type="text"/>					
4	<input type="text"/>					
5	<input type="text"/>					
6	<input type="text"/>					

© 2017 geobra Brandstätter Stiftung & Co. KG  
 Brandstätterstraße 2-10 No. 30801814  
 90513 Zirndorf/Germany 10.16

5

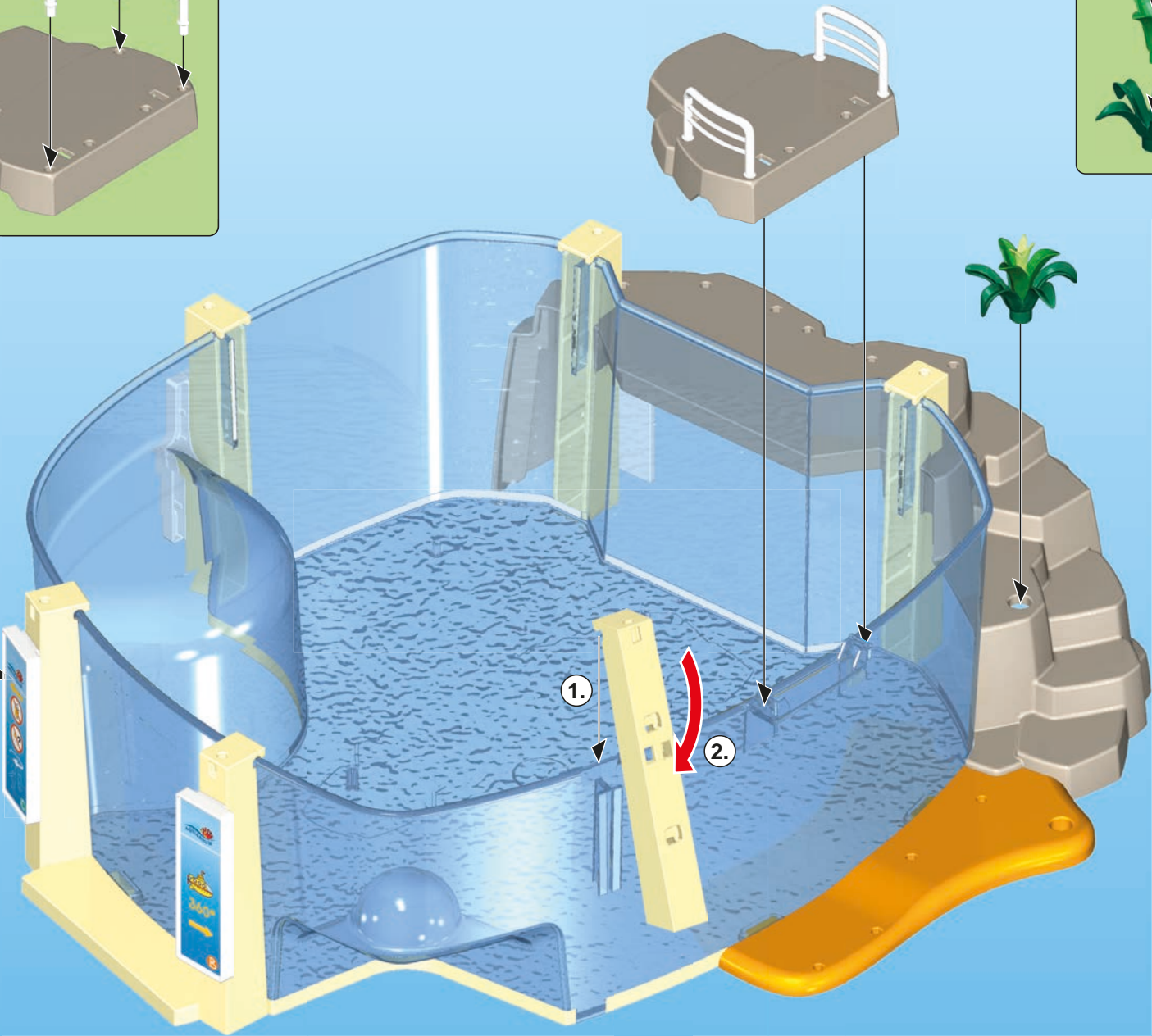
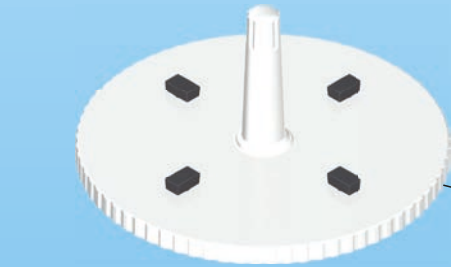
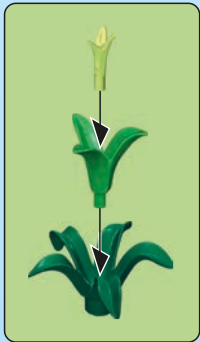
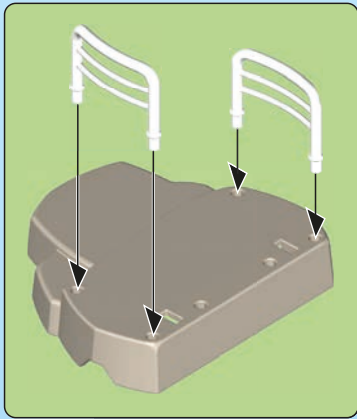
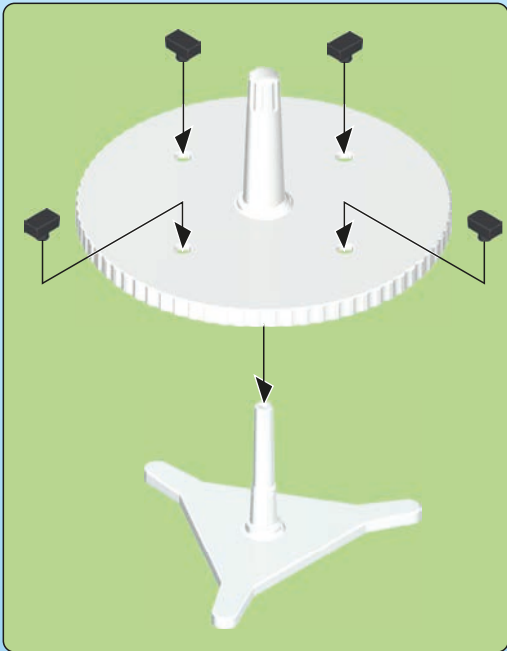

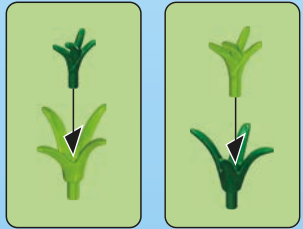
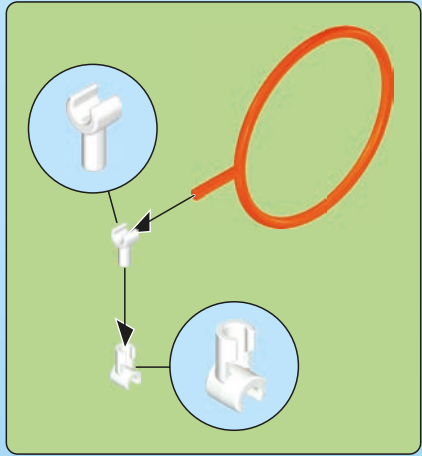

6

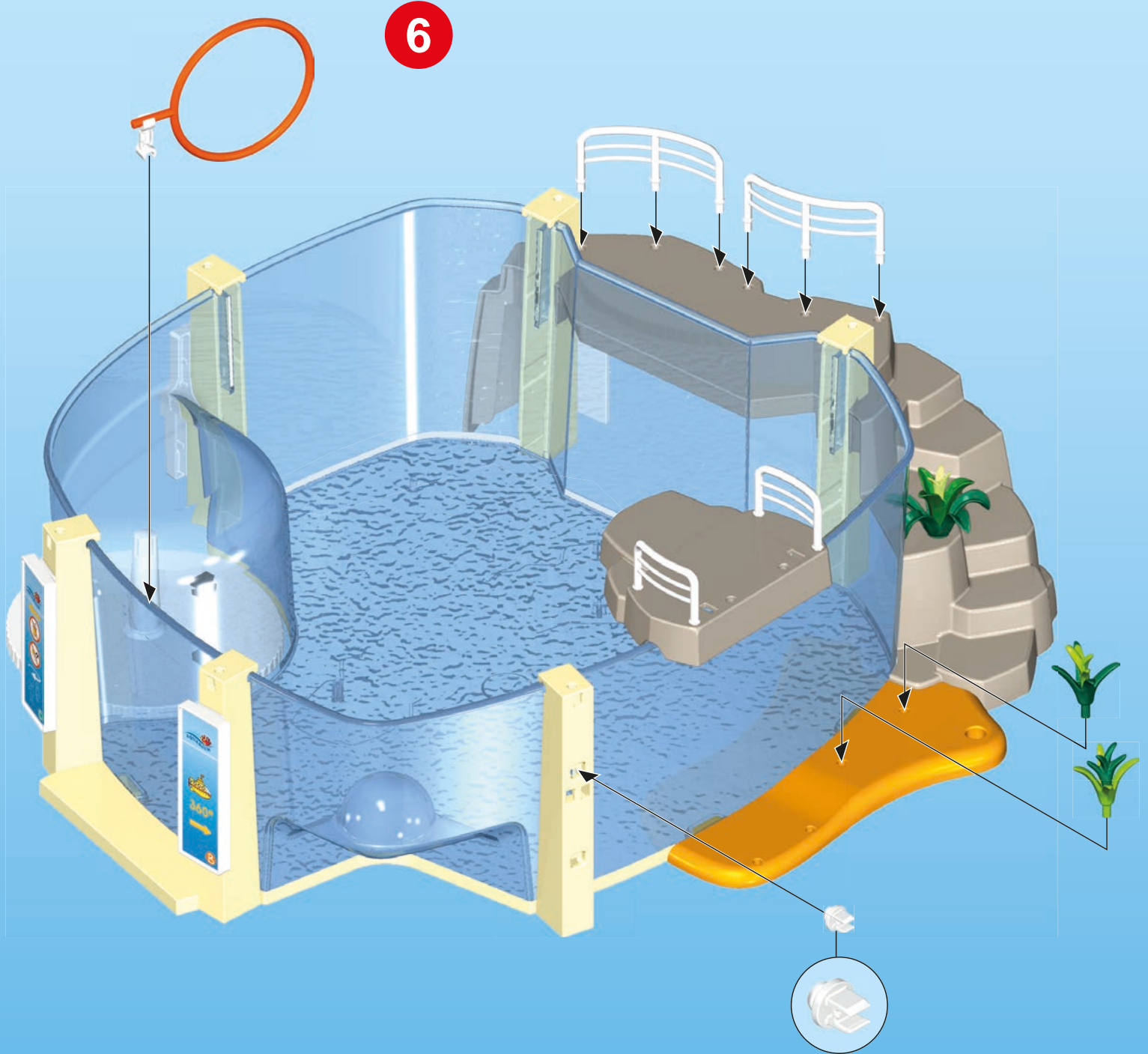

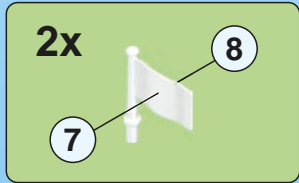
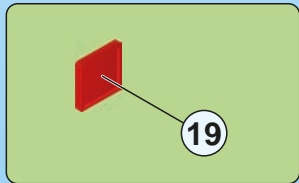
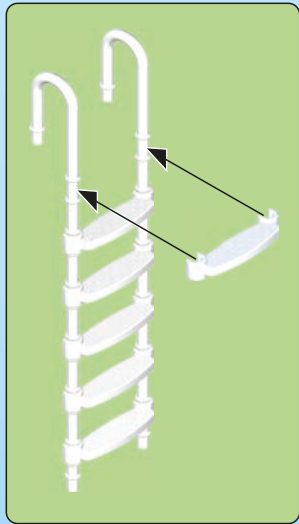

7	7	9	11	13	15	17
AQUARIUM	AQUARIUM	AQUARIUM	AQUARIUM	AQUARIUM	AQUARIUM	
8	8	10	12	14	16	18
AQUARIUM	AQUARIUM	AQUARIUM	AQUARIUM	AQUARIUM	AQUARIUM	
19	20	21	22	23		
1	_____					
2	_____					
3	_____					
4	_____					
5	_____					
6	_____					

© 2017 geobra Brandslätter Stiftung & Co. KG  
 Brandslätterstraße 2-10 No.30801814  
 90513 Zirndorf/Germany 10.16

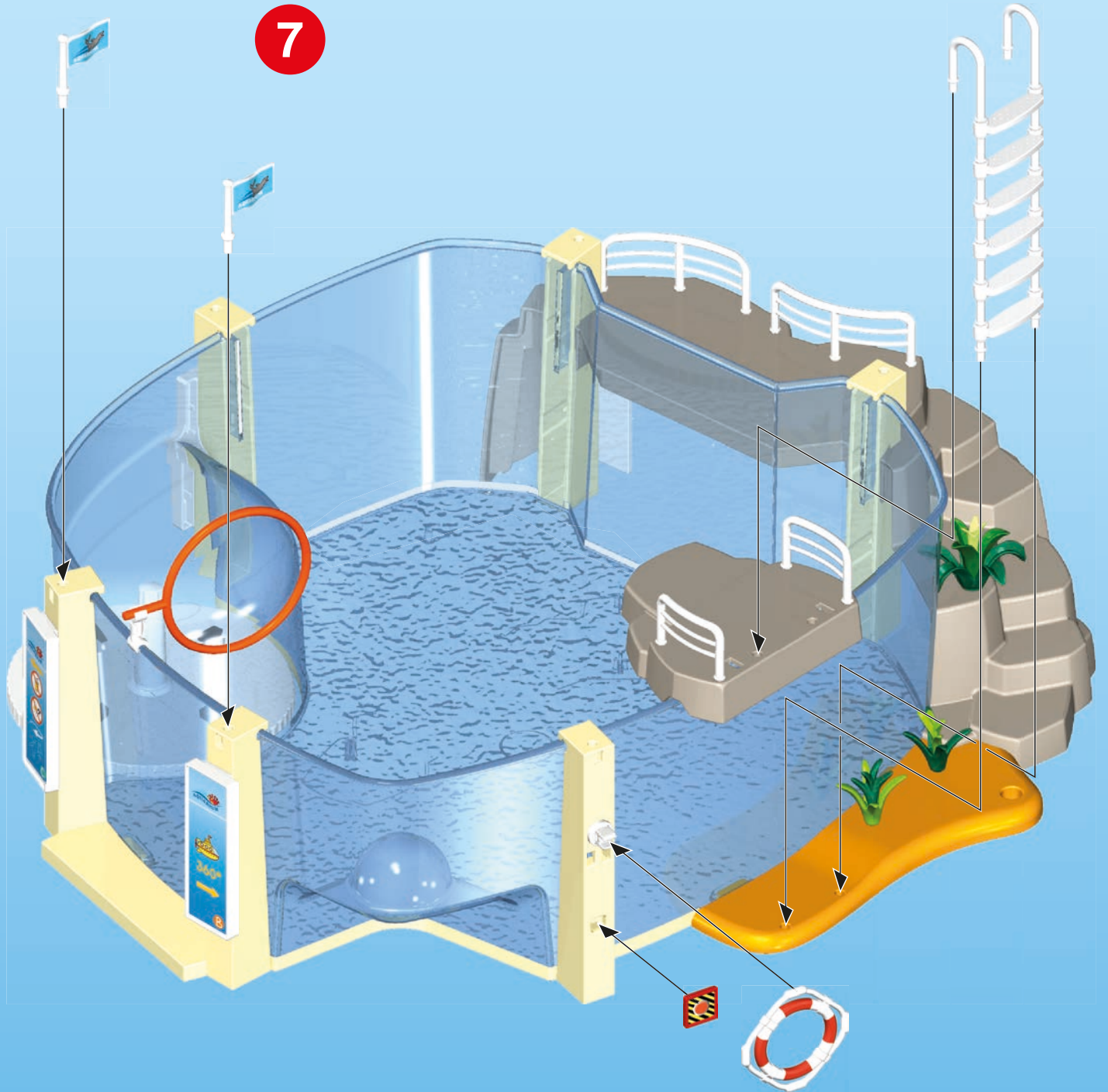



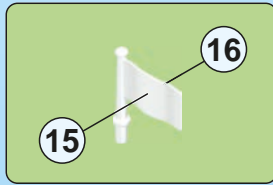
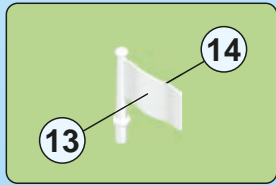
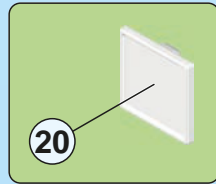
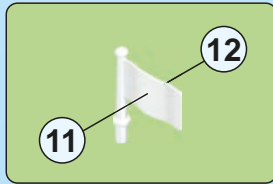
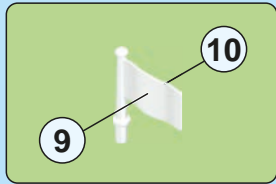

8

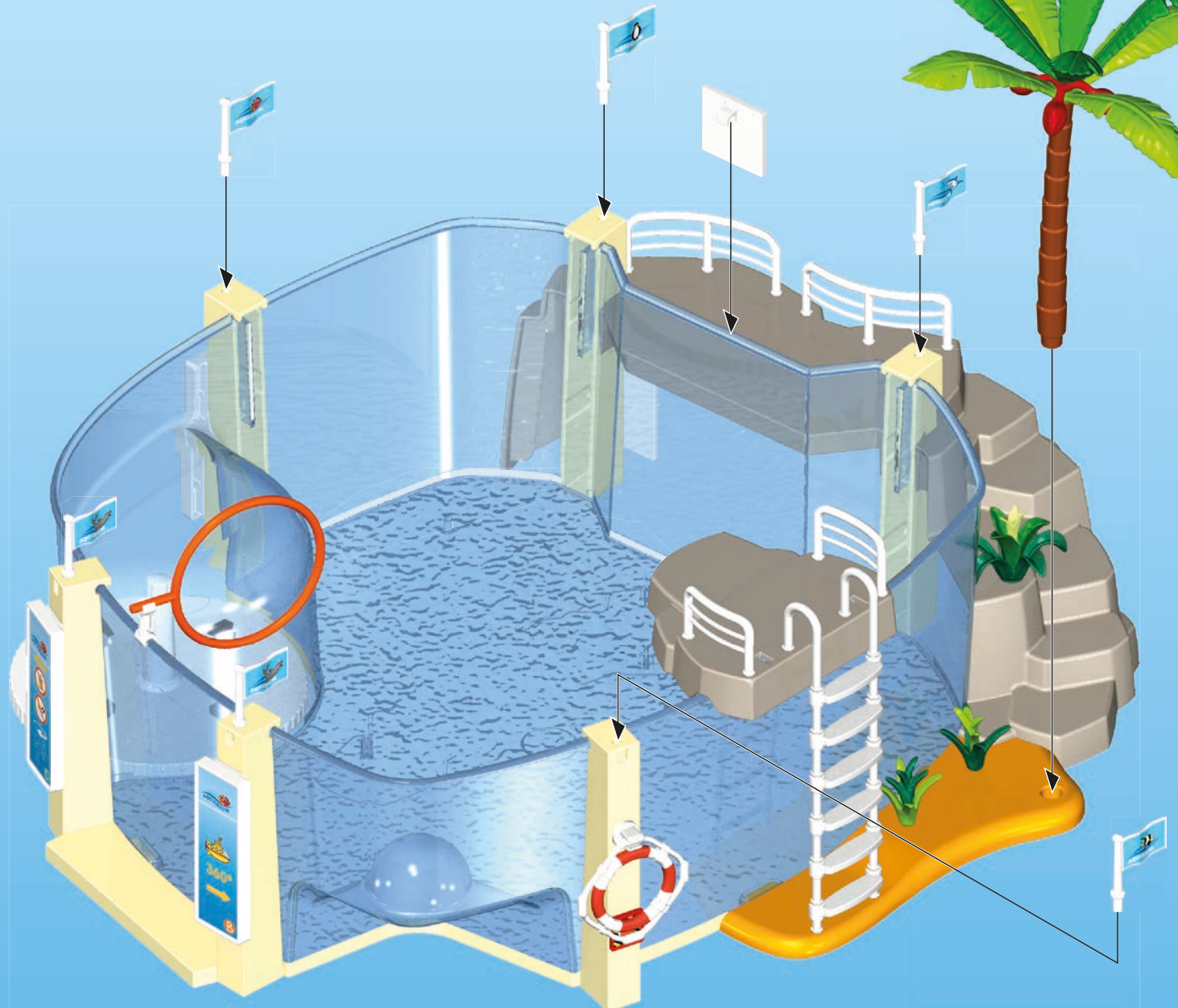

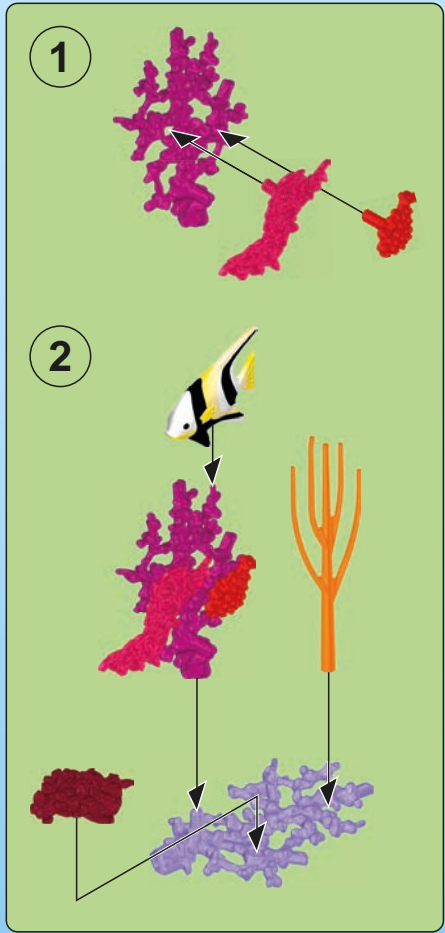

10



**(D A CH L B)** Nur Trinkwasser verwenden. Nach dem Spielen austrocknen lassen.

**(USA GB CDN M IRL)** Use only tap water. Dry thoroughly after play.

**(F CDN B L CH)** N'utiliser que de l'eau potable. Faire sécher après chaque utilisation.

**(E MEX)** Utilizar solamente agua potable. Dejar secar antes de guardar.

**(NL B)** Enkel drinkbaar water gebruiken. Na het spelen laten drogen.

**(I CH)** Usare solo acqua potabile. Asciugare bene dopo ogni uso.

**(P)** Utilizar somente água potável. Deixar secar antes de guardar.

**(DK)** Anvend kun drikkevand. Lad det tørre ud når du er færdig med at lege.

**(N)** Kun drikkevann skal benyttes. Tørk opp etter at leken er ferdig.

**(S FIN)** Använd endast dricksvatten. Låt torka efter användandet.

**(FIN)** Käytä ainoastaan juomavettä. Anna kuivua leikin jälkeen.

**(H)** Kérjük kizárólag ivóvizet használni! Játék után ajánlott a termék kiszáritása!

**(CZ)** Používat jen pitnou vodu. Po hraní nechat vyschnout.

**(EST)** Kasutada üksnes joogivett! Mängimise järel kuivatada!

**(LV)** Izmantot tikai dzeramo ūdeni. Pēc spēlēšanās ļaut nožūt.

**(LT)** Naudokite tik geriamąjį vandenį. Pažaidus, išdžiovinkite.

**(SLO)** V igračo vlivajte le pitno vodo. Po igri naj se igrača posuši.

**(SK)** Používať iba pitnú vodu. Po hre nechať vyschnúť.

**(PL)** Używaj tylko wodę pitną. Po zabawie pozostaw do wyschnięcia.

**(TR CY)** Sadece içme suyu kullanınız. Oyundan sonra kurumaya bırakın.

**(GR CY)** Χρησιμοποιείστε μόνο νερό βρύσης. Μόλις τελειώσετε, αφήστε το παιχνίδι να στεγνώσει εντελώς.

**(RO)** Se folosește doar apă potabilă. După joacă se lasă să se usuce.

**(BG)** Използвайте само питейна вода. След игра оставете да изсъхне.

**(HR)** Koristiti samo pitku vodu. Poslije igranja pustiti da se osuši.

**(CN)** 仅使用饮用水。玩耍后要干燥。

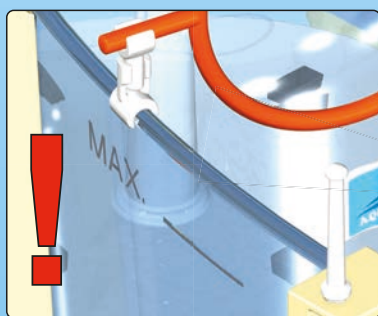

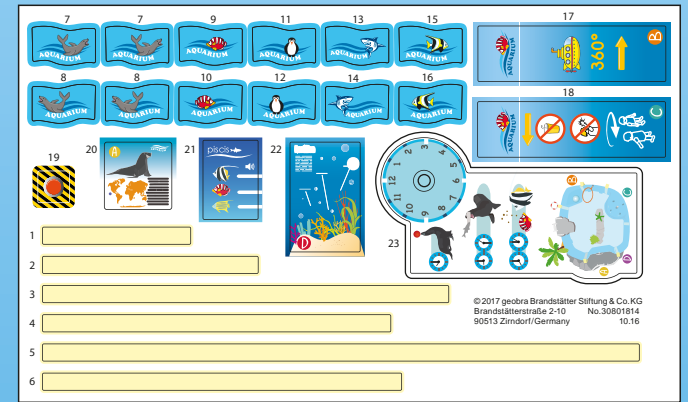
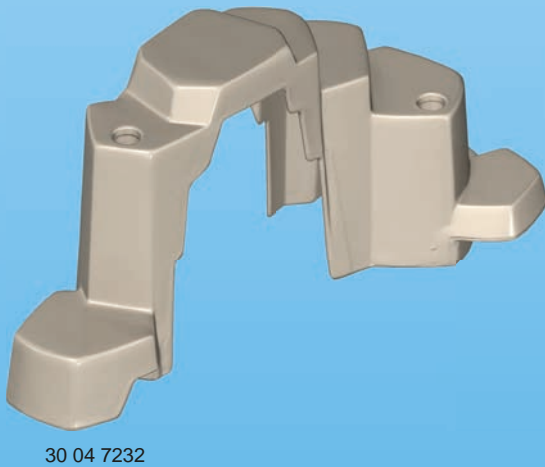
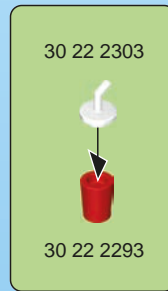
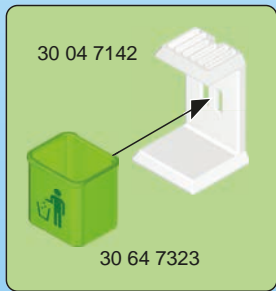
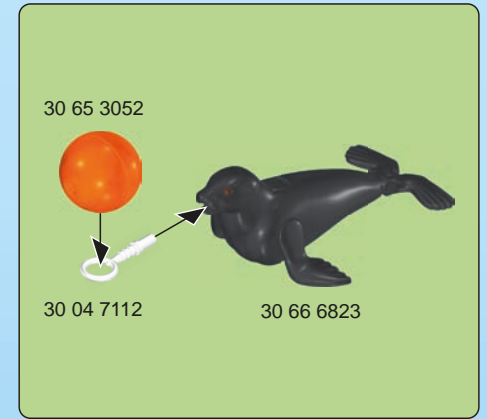
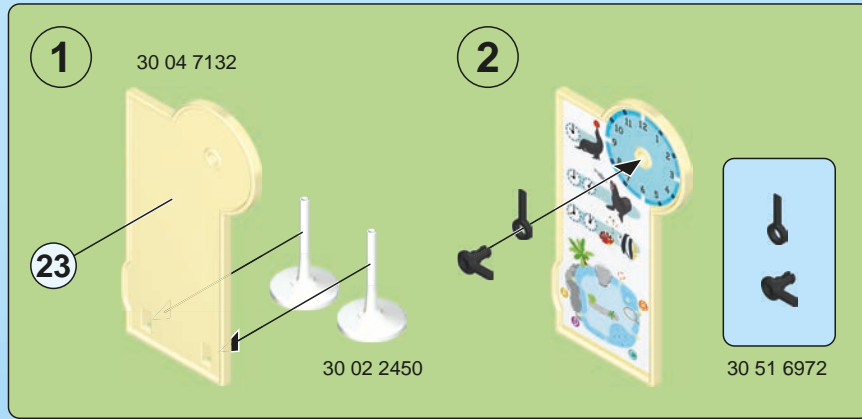
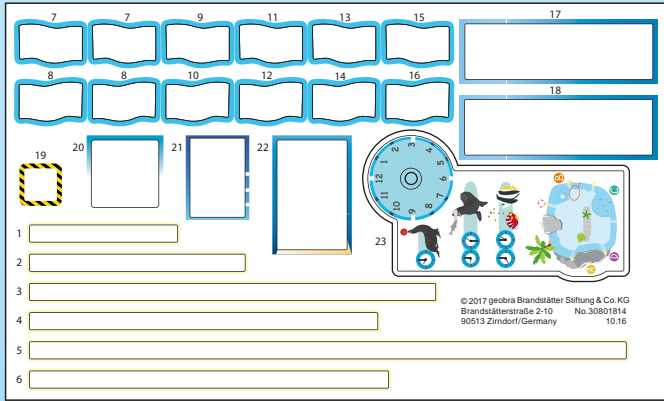

30 80 1814

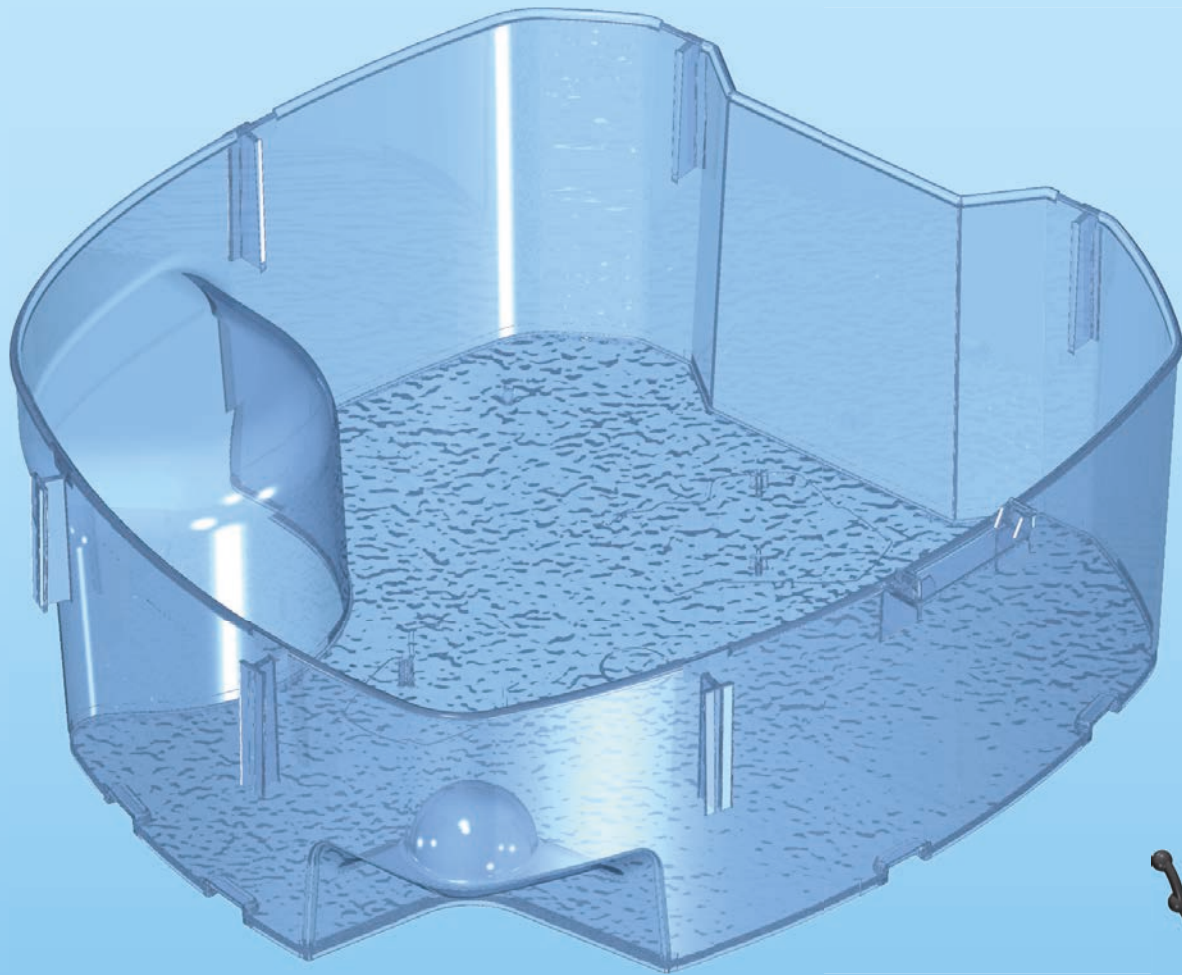

30 04 7172



30 24 7172



30 66 6823

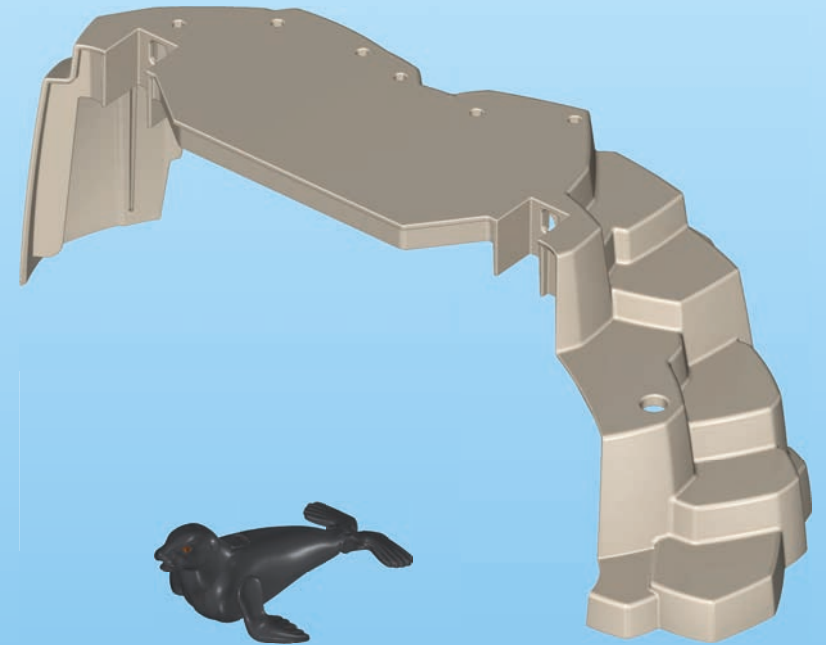

30 04 7212

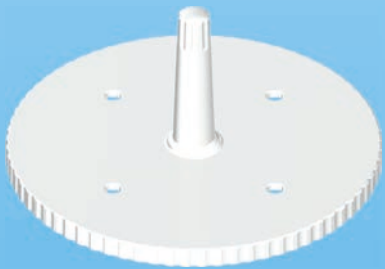

30 04 7252



30 04 7242



30 04 7192

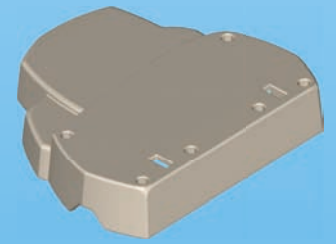

30 04 7222



6x 30 04 7182



30 26 3040



30 28 9520



30 04 7162



2x 30 04 7152



30 22 0972



30 02 9770



30 02 9470

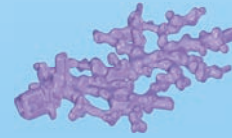

30 02 9560



30 25 9003



2x 30 04 7302



30 04 7202



30 22 5373



30 21 0242



30 20 9043



30 20 5540



30 22 0920



30 63 4860



30 64 8500



30 64 8520



30 21 1072



30 21 9002



30 21 9012



30 04 4720



2x 30 04 7292



30 27 6980



30 04 7122



30 23 0663



6x 30 25 5340



6x 30 25 0553



30 23 9852



30 09 6410



30 20 4710



30 25 1240



30 22 3992



30 20 2262



5x 30 22 6242



30 24 1862



30 61 4630



30 60 6610



4x 30 23 2040



30 21 0550



30 04 7102



30 04 7092

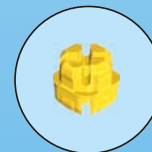

8x 30 03 6600

**UK-Importer:**  
**Playmobil UK Ltd.**  
**Regency House**  
**1 Miles Gray Road**  
**Basildon**  
**Essex**  
**SS14 3RW**  
**UK**

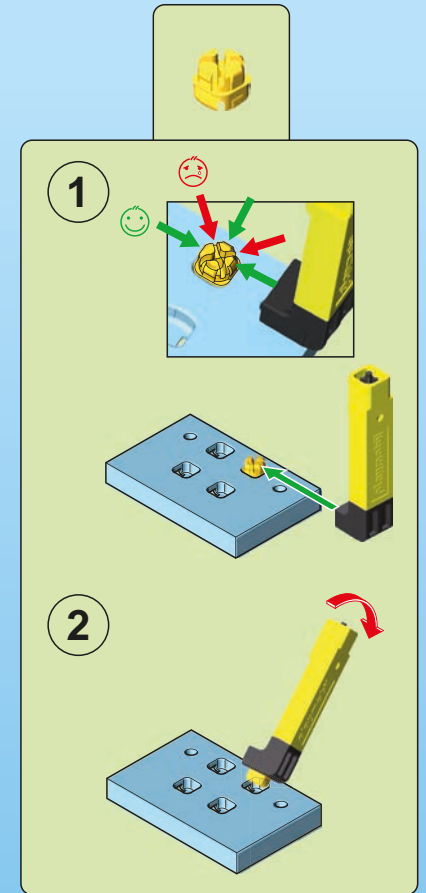

Serviceadressen finden Sie in allen PLAYMOBIL-Prospekten  
 Addresses of Customer Service Departments are shown in all PLAYMOBIL catalogues  
 L'adresse du service consommateurs est indiquée dans tous les catalogues PLAYMOBIL  
 Troverete gli indirizzi dei centri di assistenza in tutti i cataloghi PLAYMOBIL

In alle PLAYMOBIL catalogi vindt u het adres van onze klantendienst.  
 Las Direcciones de los Departamentos de Servicio al Consumidor se encuentran en todos los catálogos PLAYMOBIL  
 Η διεύθυνση του Γραφείου Εξυπηρέτησης Καταναλωτών PLAYMOBIL βρίσκεται σε όλους τους καταλόγους PLAYMOBIL.  
 pronounced: plāy-mō-bēēl

