

playmobil®

Dollhouse



70985

**NEU new**  
Nouveau  
nuevo



Aufbauen leicht gemacht mit nummerierten Tüten.  
Viel Spaß mit deinem neuen PLAYMOBIL-Spielzeug!

Set-up made easy with numbered bags.  
Have fun with your new PLAYMOBIL toy!

Simplicité de montage avec les sachets numérotés.  
Amuse-toi avec tes nouveaux PLAYMOBIL!

El montaje es más fácil con las  
bolsas numeradas.  
¡Diviértete con tu nuevo  
juguete de PLAYMOBIL!





# WARNING: CHOKING HAZARD

Small parts. Not for children under 3 years.

"Ne concerne que les USA"

Wichtige Unterlagen, bitte sorgfältig aufbewahren!  
Important: Please keep these instructions for future reference!  
Documents importants, à conserver soigneusement!  
¡Por favor, guarde estas instrucciones para el futuro!  
Belangrijke documenten, bewaar deze zorgvuldig!

Abbildungen können vom Original abweichen.  
Product may differ from image shown.  
Les illustrations peuvent différer de l'original.  
Las ilustraciones pueden diferir del original.  
Afbeltingen kunnen verschillen van het werkelijke artikel.

Serviceadressen finden Sie in allen  
PLAYMOBIL-Prospekten

Addresses of Customer Service Depart-  
ments are shown in all PLAYMOBIL  
catalogues

L'adresse du service consommateurs  
est indiquée dans tous les catalogues  
PLAYMOBIL

Troverete gli indirizzi dei centri di  
assistenza in tutti i cataloghi PLAYMOBIL

In alle PLAYMOBIL catalogi vindt u  
het adres van onze klantendienst.

Las Direcciones de los Departamentos  
de Servicio al Consumidor se encuentran  
en todos los catálogos PLAYMOBIL

Η διεύθυνση του Γραφείου Εξυπηρέτησης  
Καταναλωτών PLAYMOBIL βρίσκεται σε  
όλους τους καταλόγους PLAYMOBIL.

pronounced: plāy-mō-beel

**UK-Importer:**  
**Playmobil UK Ltd.**  
**Regency House**  
**1 Miles Gray Road**  
**Basildon**  
**Essex**  
**SS14 3RW**  
**UK**

**UK  
CA**

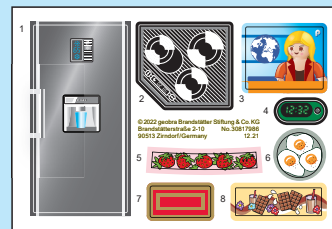

30 81 7986

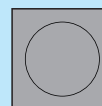

30 88 5472



30 89 1910



Adresses sur [quefairedemesdechets.fr](http://quefairedemesdechets.fr)



+

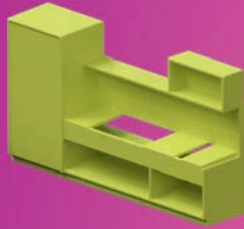

2

1

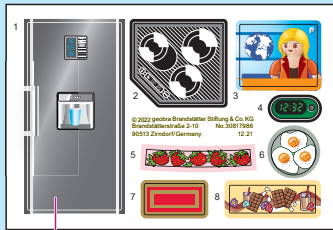

1

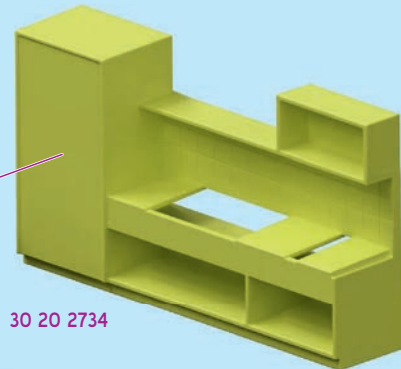

30 20 2734

30 21 1142

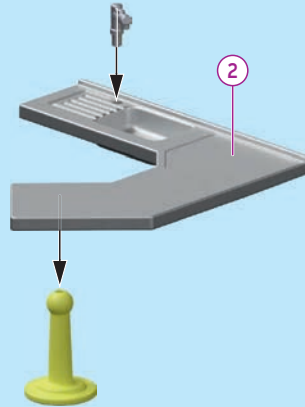

30 20 2744

30 20 2754

3

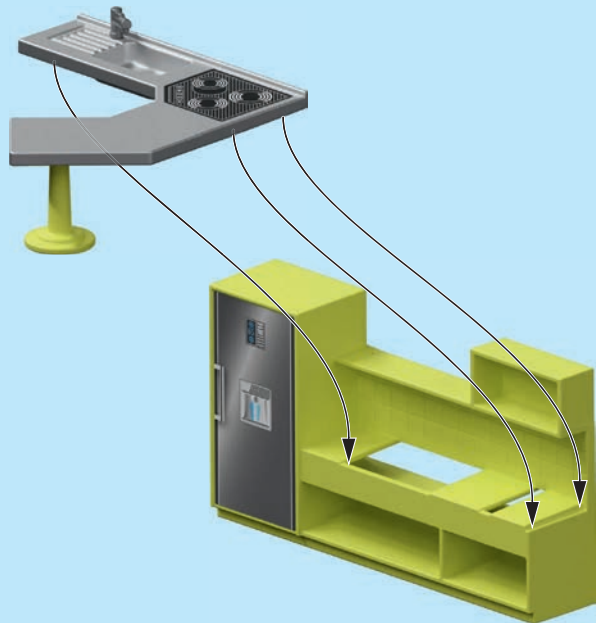

2x



30 07 4590

30 07 4580



30 64 5577

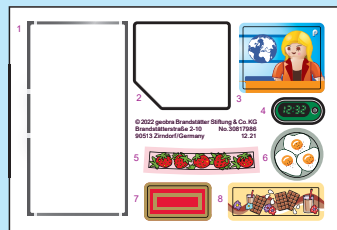

30 61 5512



2x 30 20 2774

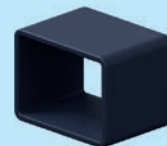

30 20 2784



30 20 2794



30 06 9553





2x

30 20 2994

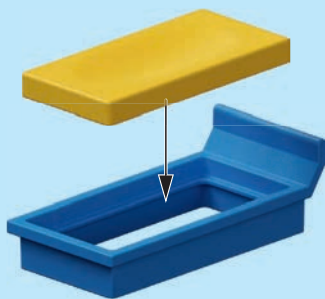

30 24 2292

30 05 3180

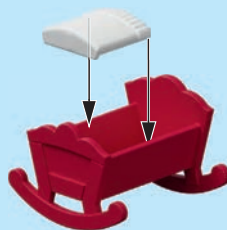

30 20 2804

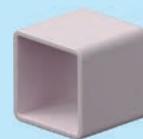

30 09 9072





30 24 2232



30 24 2222



30 07 1620

30 21 4962

30 24 2202

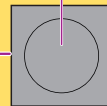
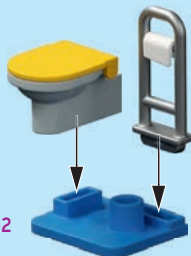

30 24 2182

30 20 0250



30 24 2172

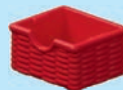

30 24 2242

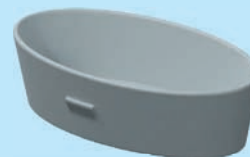

30 24 2192



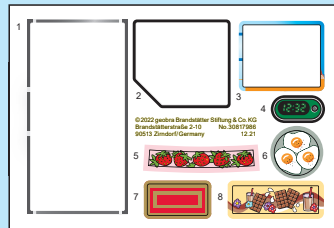

30 08 9713

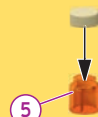

30 22 0890



30 22 7110



30 00 1885



30 14 1740



30 12 1480



30 21 1172



30 61 2170



30 06 9160



30 24 2212



30 25 2613



30 64 5617



30 24 2322



2x 30 22 4443



30 22 3822



30 03 3343



30 24 2252



2x 30 05 0362



30 26 9530



2x 30 06 3203



30 27 0570



30 29 1770



30 27 4260



30 81 8736

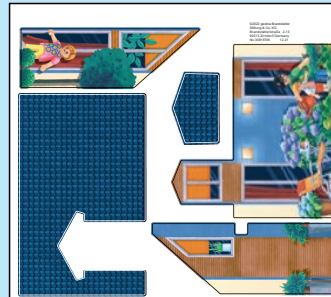

30 81 8746

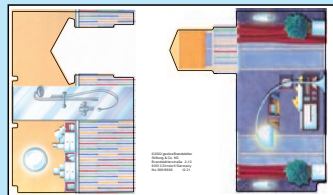

30 81 8936

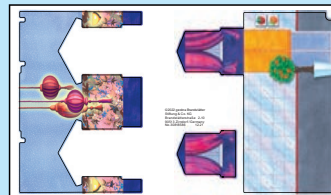

30 81 8586



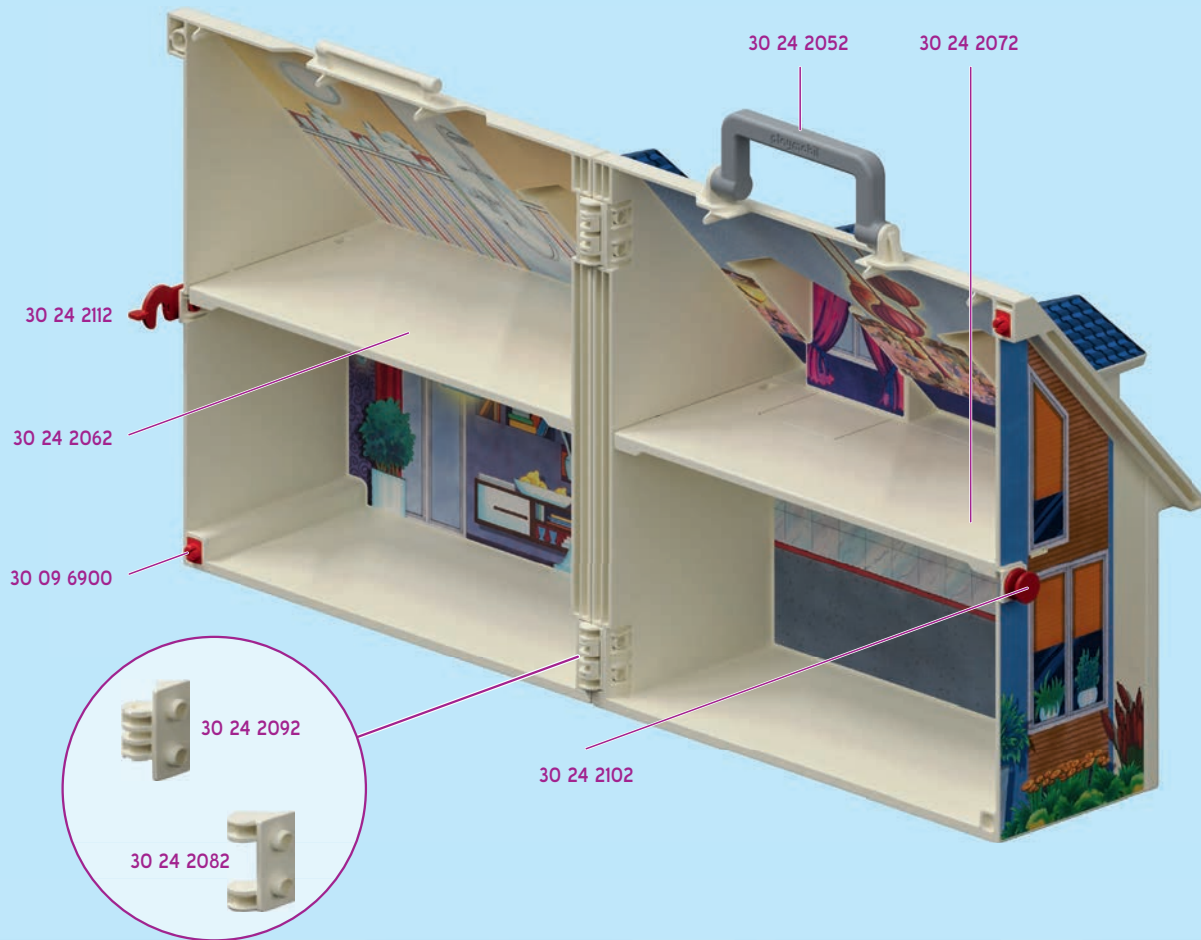



70210



70207



70211



70209



70208



70985

©2021 geobra Brandstätter Stiftung & Co. KG  
Brandstätterstr. 2-10 • 90513 Zimndorf, Germany  
No. 30 82 3746 07-23

