

playmobil®

CANYON COPTER
RESCUE

RESCUE
ACTION



70663

1

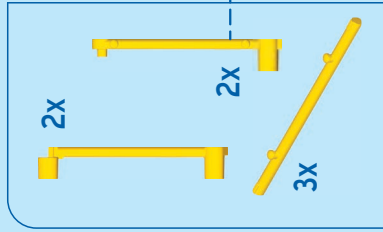

30 51 1972

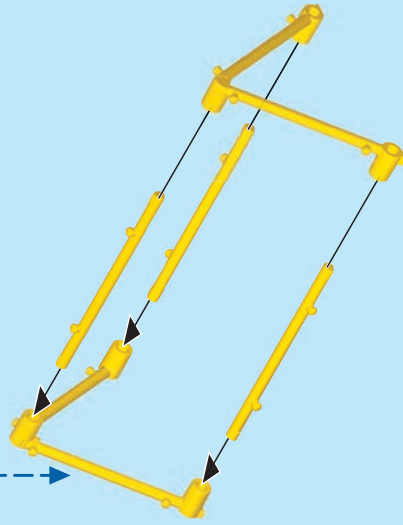
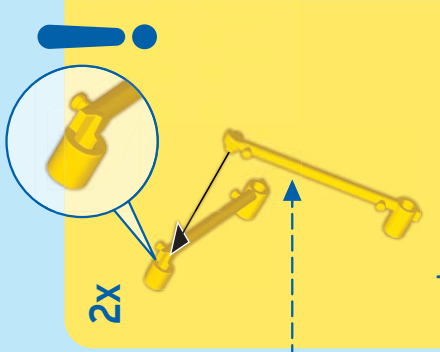

2

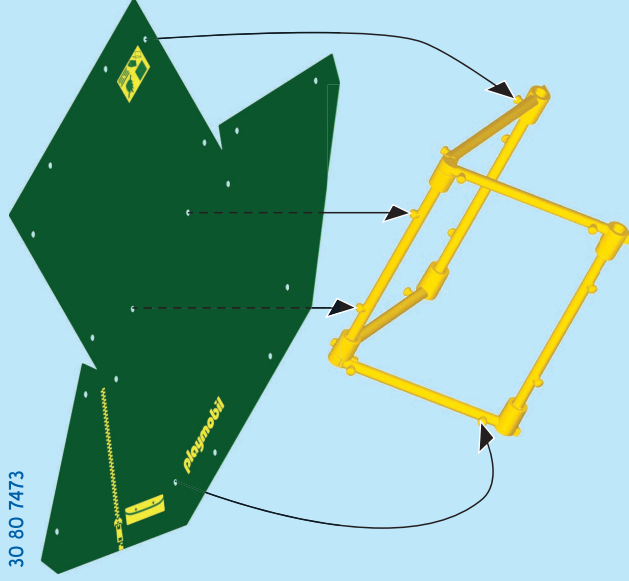

3

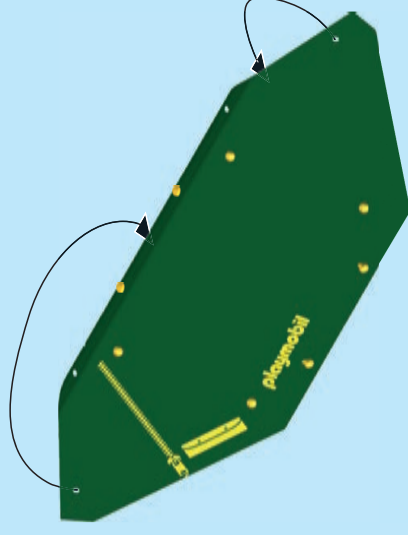

3

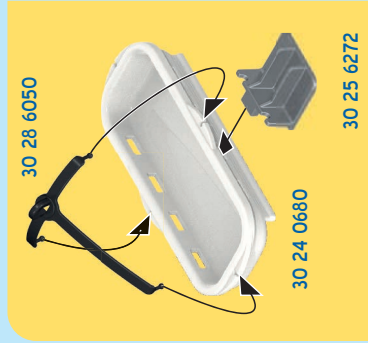

4

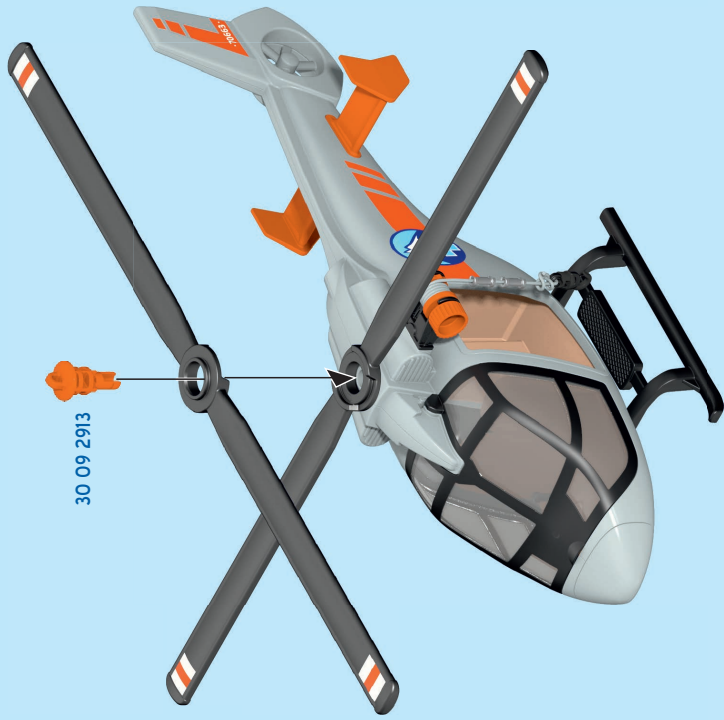
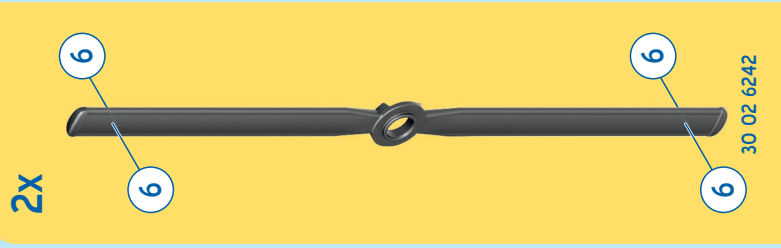
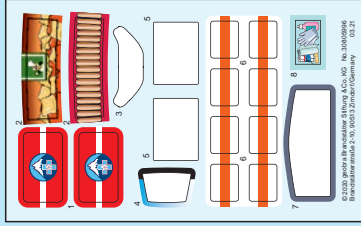

1

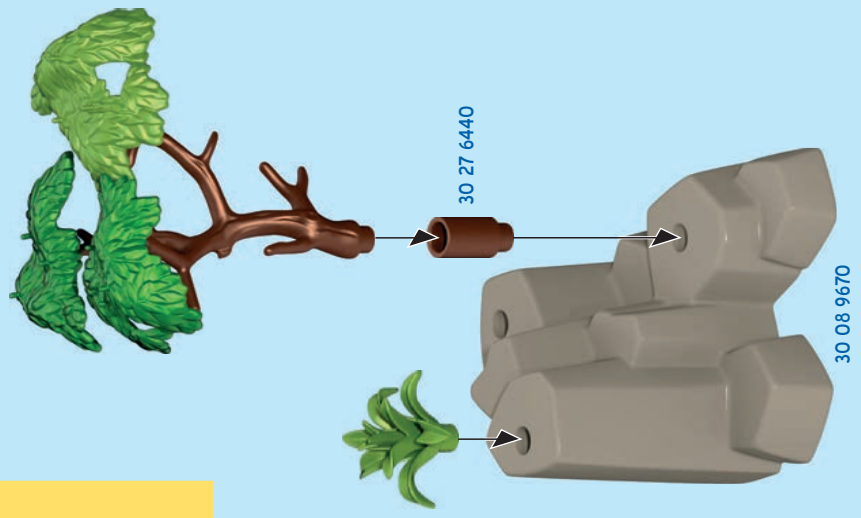
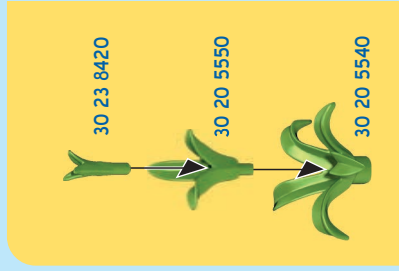

2

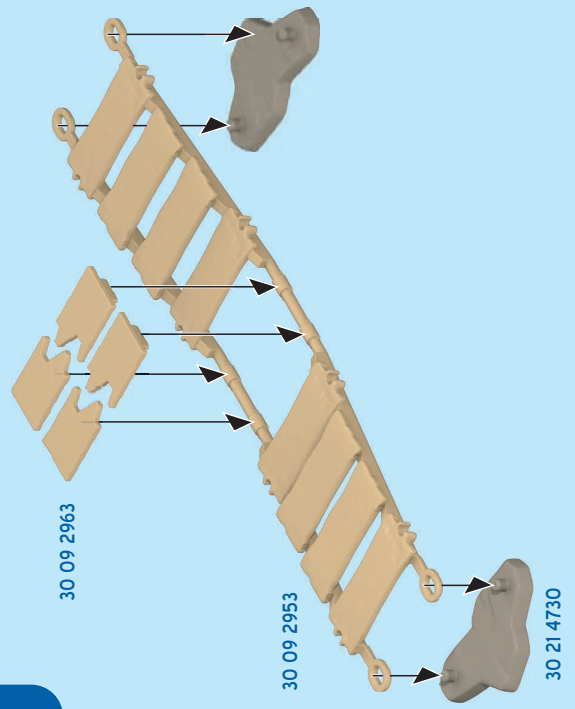

3

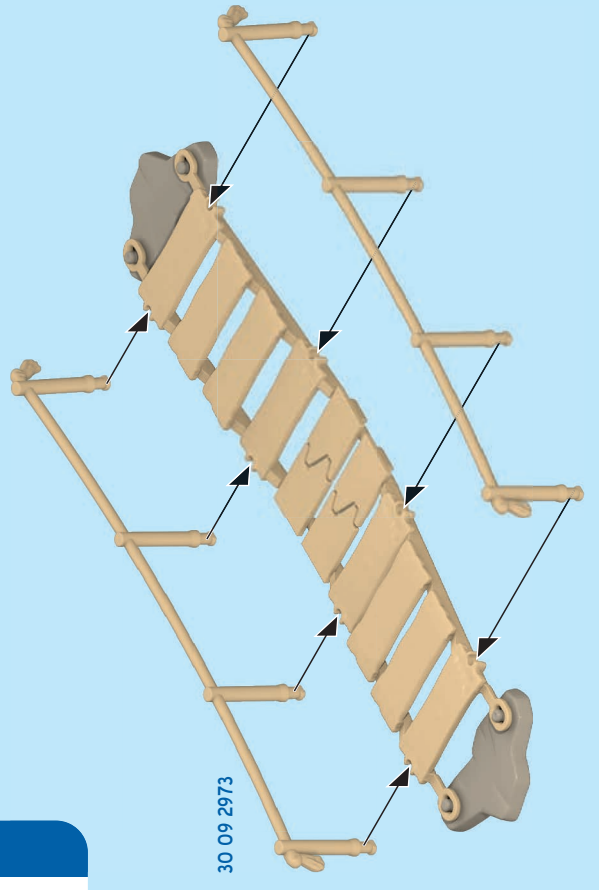

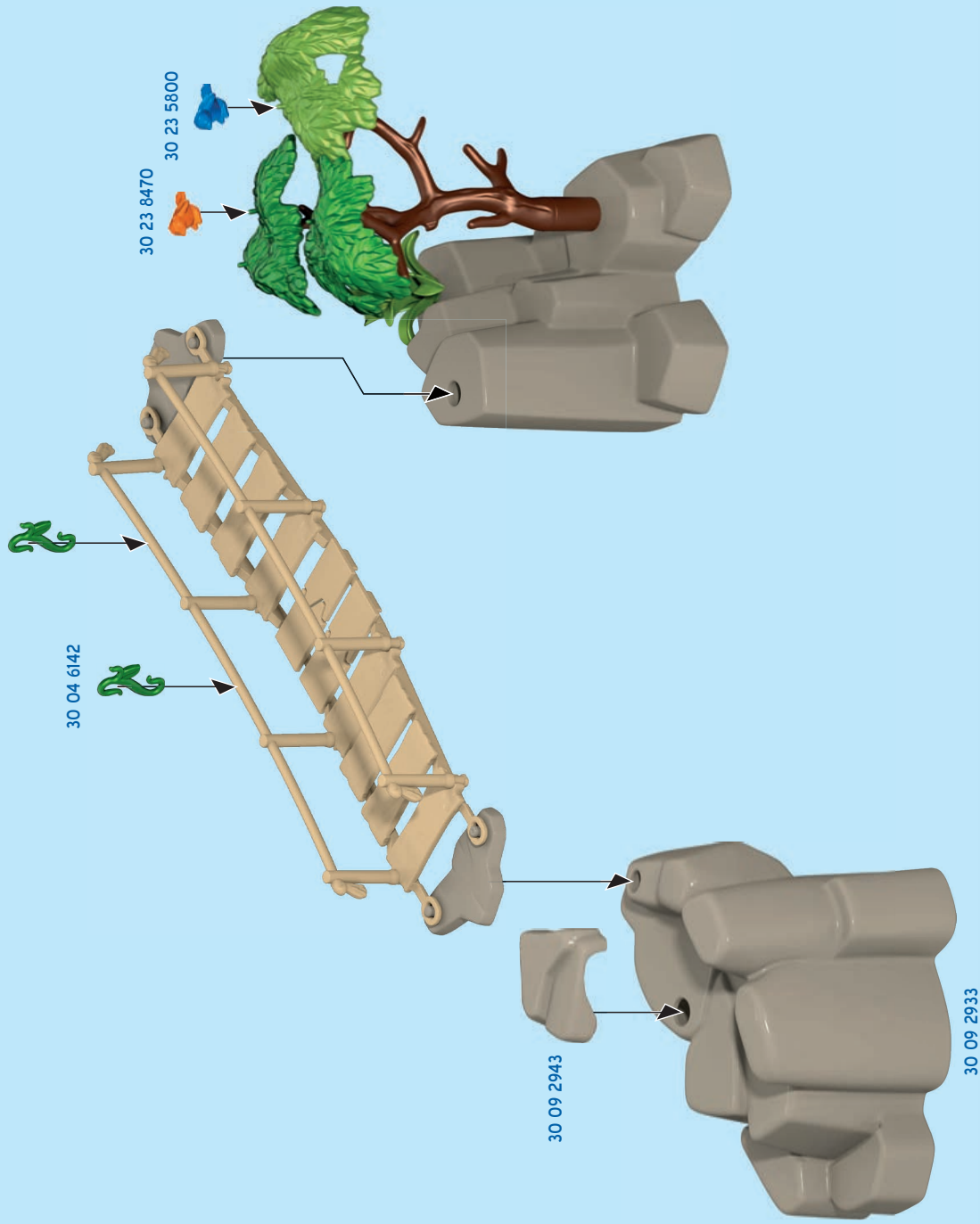

30 09 2943

30 04 6142

30 23 8470

30 23 5800

30 09 2933

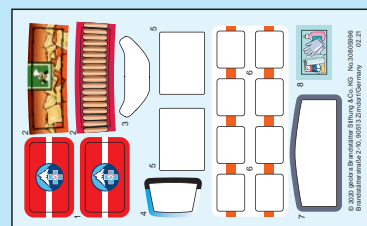

© 2020 LEGO System A/S. Alle Rechte vorbehalten.
 LEGO, die LEGO-Markierung und die LEGO-Logo sind eingetragene
 Marken der LEGO Group in Dänemark, den USA und anderen Ländern.

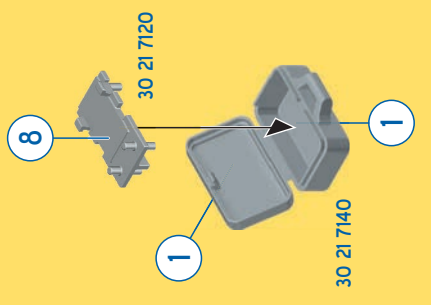

8

1

30 21 740



30 05 0040

2

30 23 1300

2x



30 67 4330



30 22 1232



30 63 4863



30 04 3572



30 25 0173



30 03 4630



○ 70661



○ 70662



✓ 70663



○ 70048



○ 70049



○ 70050



○ 70051



©2021 geobra Brandstätter Stiftung & Co. KG
 Brandstätterstr. 2-10 • 90513 Zirndorf, Germany
 No. 30 81 5025
 07.22



PAP 22
 FSC Recycled
 FSC C01234