

playmobil®

ADVENTURE VAN

OFF-ROAD
ACTION



70660



WARNING: CHOKING HAZARD

Small parts. Not for children under 3 years.

”Ne concerne que les USA“

Wichtige Unterlagen, bitte sorgfältig aufbewahren!
Important: Please keep these instructions for future reference!
Documents importants, à conserver soigneusement!
¡Por favor, guarde estas instrucciones para el futuro!
Belangrijke documenten, bewaar deze zorgvuldig!

Abbildungen können vom Original abweichen.
Product may differ from image shown.
Les illustrations peuvent différer de l'original.
Las ilustraciones pueden diferir del original.
Afbeeldingen kunnen verschillen van het werkelijke artikel.

Serviceadressen finden Sie in allen
PLAYMOBIL-Prospekten

Addresses of Customer Service Depart-
ments are shown in all PLAYMOBIL
catalogues

L'adresse du service consommateurs
est indiquée dans tous les catalogues
PLAYMOBIL

Troverete gli indirizzi dei centri di
assistenza in tutti i cataloghi PLAYMOBIL

In alle PLAYMOBIL catalogi vindt u
het adres van onze klantendienst.

Las Direcciones de los Departamentos
de Servicio al Consumidor se encuentran
en todos los catálogos PLAYMOBIL

Η διεύθυνση του Γραφείου Εξυπηρέτησης
Καταναλωτών PLAYMOBIL βρίσκεται σε
όλους τους καταλόγους PLAYMOBIL.

pronounced: plāy-mō-bēē

1



3



3



© 2000 Playmobil Spielzeug GmbH & Co. KG
Bismarckstraße 2-10, No. 36042/01
60533 Züschen/Germany
01-21



2

3x

1

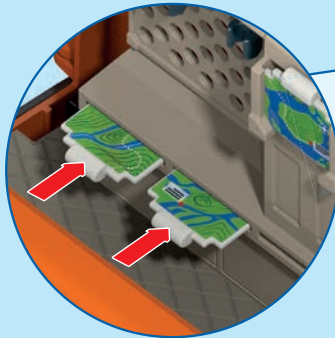

3

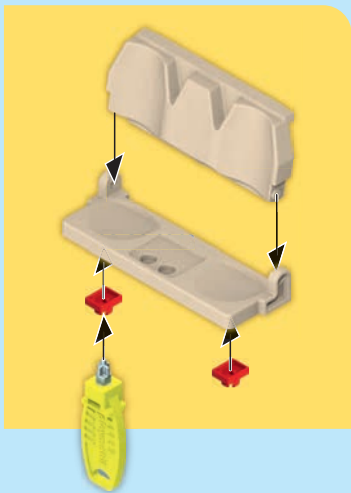

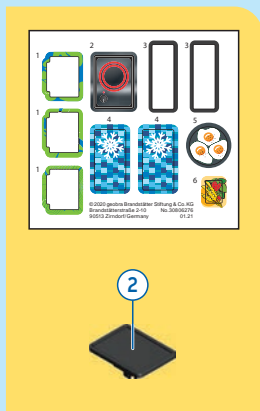
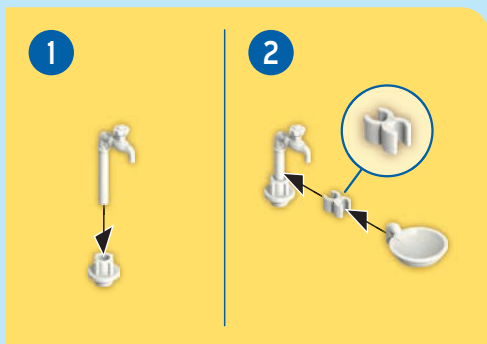

5

4x

1



2

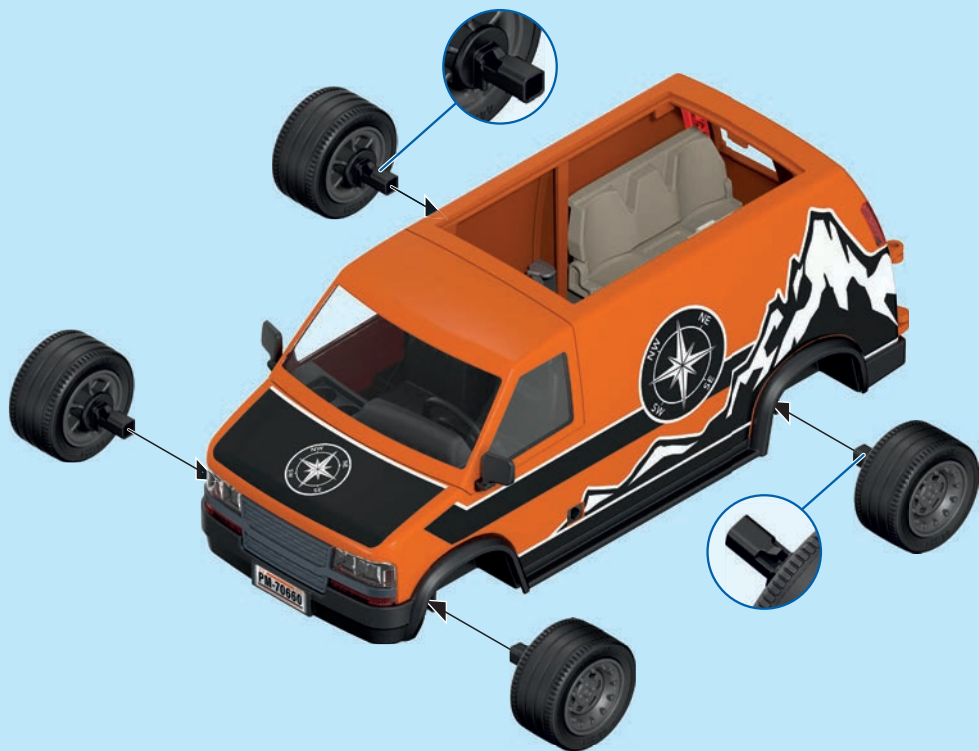

1

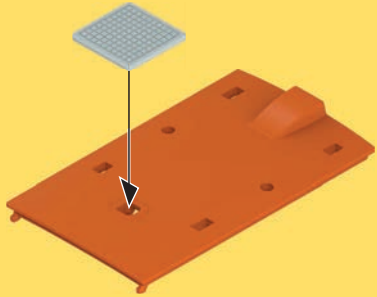

2

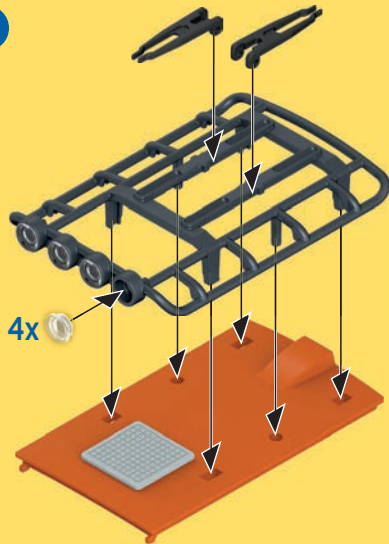



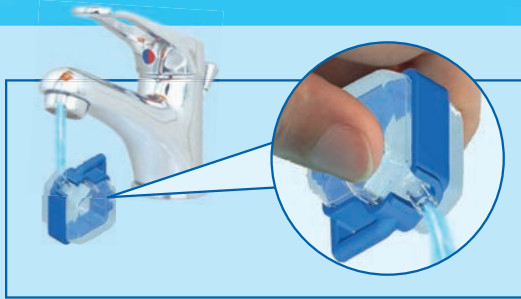

DE AT CH LU BE Nur Trinkwasser verwenden. Nach dem Spielen austrocknen lassen.

US GB CA MT IE Use only tap water. Dry thoroughly after play.

FR CA BE LU CH N'utiliser que de l'eau potable. Faire sécher après chaque utilisation.

ES MX Utilizar solamente agua potable. Dejar secar antes de guardar.

NL BE Enkel drinkbaar water gebruiken. Na het spelen laten drogen.

IT CH Usare solo acqua potabile. Asciugare bene dopo ogni uso.

PT Utilizar somente água potável. Deixar secar antes de guardar.

DK Anvend kun drikkevand. Lad det tørre ud når du er færdig med at lege.

NO Kun drikkevann skal benyttes. Tørk opp etter at leken er ferdig.

SE FI Använd endast dricksvatten. Låt torka efter användandet.

FI Käytä ainoastaan juomavettä. Anna kuivua leikin jälkeen.

HU Kérjük kizárólag ivóvizet használnjon! Játék után ajánlott a termék kiszáritása!

CZ Používat jen pitnou vodu. Po hraní nechat vyschnout.

EE Kasutada üksnes joogivett! Mängimise järel kuivatada!

LV Izmantot tikai dzeramo ūdeni. Pēc spēlēšanās ļaut nožūt.

LT Naudokite tik geriamąjį vandenį. Pažaidus, išdžiovinkite.

SI V igračo vlivajte le pitno vodo. Po igri naj se igrača posuši.

SK Používať iba pitnú vodu. Po hre nechať vyschnúť.

PL Używaj tylko wodę pitną. Po zabawie pozostaw do wyschnięcia.

TR CY Sadece içme suyu kullanınız. Oyundan sonra kurumaya bırakın.

GR CY Χρησιμοποιείτε μόνο νερό βρύσης. Μόλις τελειώσετε, αφήστε το παιχνίδι να στεγνώσει εντελώς.

RO Se folosește doar apă potabilă. După joacă se lasă să se usuce.

BG Използвайте само питейна вода. След игра оставете да изсъхне.

HR Koristiti samo pitku vodu. Poslije igranja pustiti da se osuši.

RU Используйте только питьевую воду. Дайте высохнуть после игры.

CN 仅使用饮用水。玩耍后要干燥。

1



2





30 23 3110

30 09 7493

30 25 0523

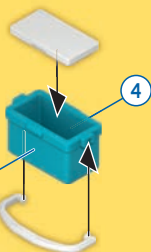

30 20 7503

30 09 7443



30 25 8542

30 07 3840



30 21 3482

30 09 7473



30 09 7463

30 03 0743



30 25 2683



30 00 9124



30 66 4600



30 51 1763

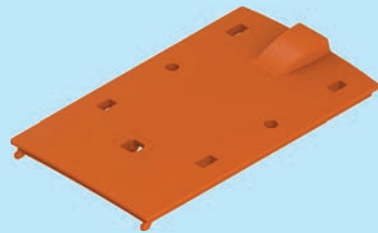

30 09 7633



30 09 7653



30 80 6276



30 61 2422



30 09 7663



4x 30 82 6310



30 21 1383

30 81 6420



30 64 7940



4x 30 09 7613



30 66 0073



30 09 7503

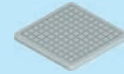

30 09 7643



30 28 7180



2x 30 06 9450



3x 30 09 7433



30 09 7483



30 29 8040



4x 30 20 6502



30 25 6450



4x 30 09 7623



30 08 4073



30 21 0540



30 08 4220



2x 30 28 9280



30 07 9522



2x 30 09 6900



4x 30 28 8060



3x 30 24 5722



30 65 8822



30 61 2170



30 51 6860



30 46 7272

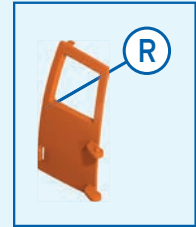

30 46 7562



30 20 2682



UK-Importer:
Playmobil UK Ltd.
Regency House
1 Miles Gray Road
Basildon
Essex
SS14 3RW
UK





70532



70460



70660

OFF-ROAD ACTION



©2021 geobra Brandstätter Stiftung & Co. KG
Brandstätterstr. 2-10 • 90513 Zimdorf, Germany
No. 30 81 3865 07.22

