

playmobil®

Family Fun



70537





**WARNING:**  
**CHOKING HAZARD**

Contains a small ball and small parts.  
Not for children under 3 years.

"Ne concerne que les USA"

UK-Importer:  
**Playmobil UK Ltd.**  
Regency House  
1 Miles Gray Road  
Basildon  
Essex  
SS14 3RW  
UK



Wichtige Unterlagen, bitte sorgfältig aufbewahren!  
Important: Please keep these instructions for future reference!  
Documents importants, à conserver soigneusement!  
¡Por favor, guarde estas instrucciones para el futuro!  
Belangrijke documenten, bewaar deze zorgvuldig!

Abbildungen können vom Original abweichen.  
Product may differ from image shown.  
Les illustrations peuvent différer de l'original.  
Las ilustraciones pueden diferir del original.  
Afbeeldingen kunnen verschillen van het werkelijke artikel.

Serviceadressen finden Sie in allen  
PLAYMOBIL-Prospekten

Addresses of Customer Service Depart-  
ments are shown in all PLAYMOBIL  
catalogues

L'adresse du service consommateurs  
est indiquée dans tous les catalogues  
PLAYMOBIL

Troverete gli indirizzi dei centri di  
assistenza in tutti i cataloghi PLAYMOBIL

In alle PLAYMOBIL catalogi vindt u  
het adres van onze klantendienst.

Las Direcciones de los Departamentos  
de Servicio al Consumidor se encuentran  
en todos los catálogos PLAYMOBIL

Η διεύθυνση του Γραφείου Εξυπηρέτησης  
Καταναλωτών PLAYMOBIL βρίσκεται σε  
όλους τους καταλόγους PLAYMOBIL.

pronounced: pläy-mō-bēēl

1

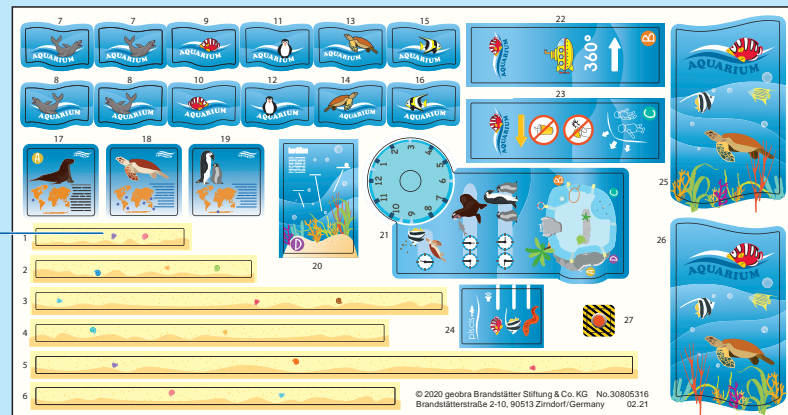
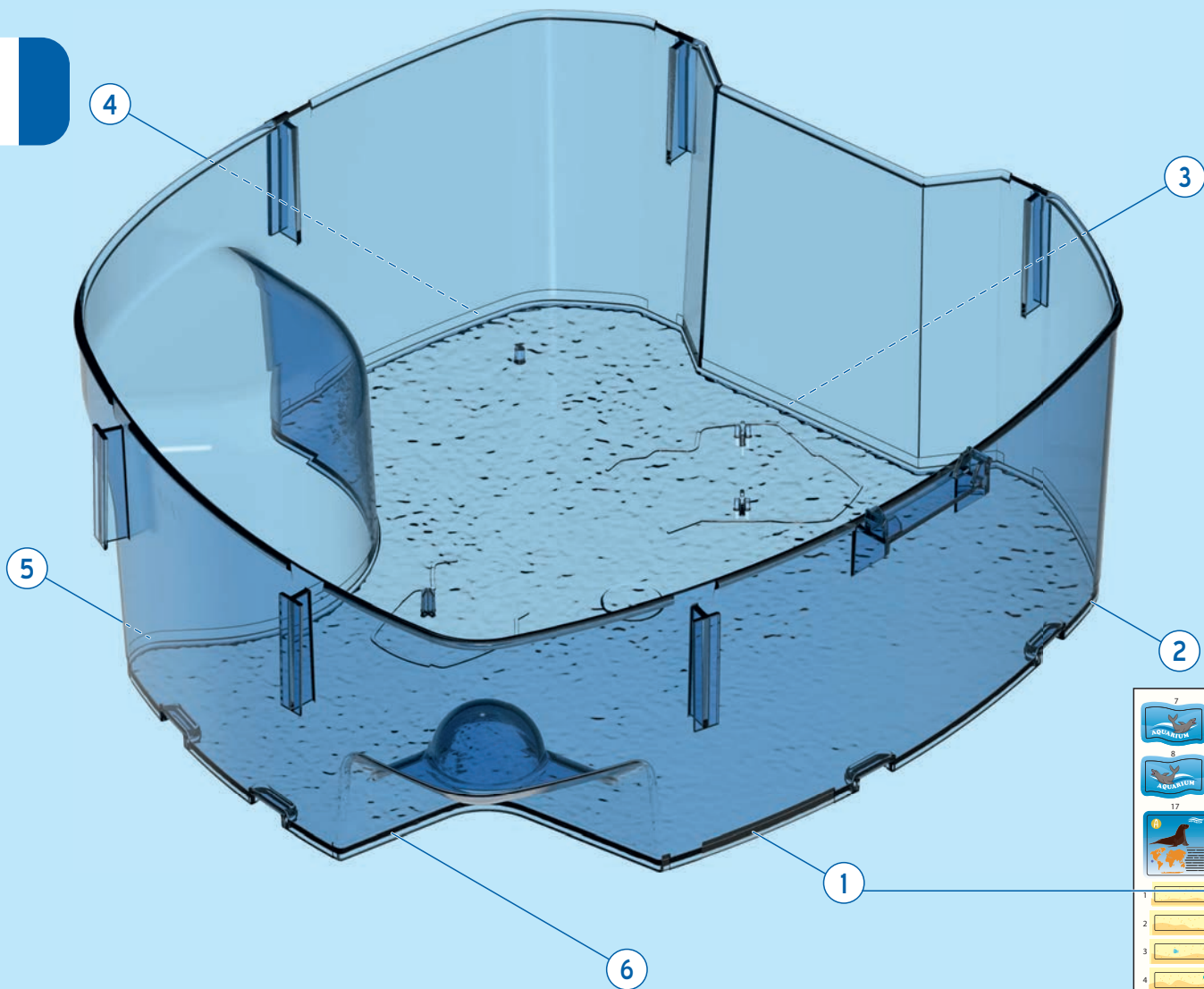

2

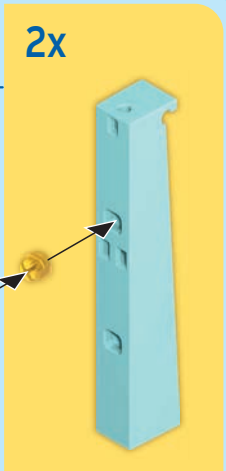
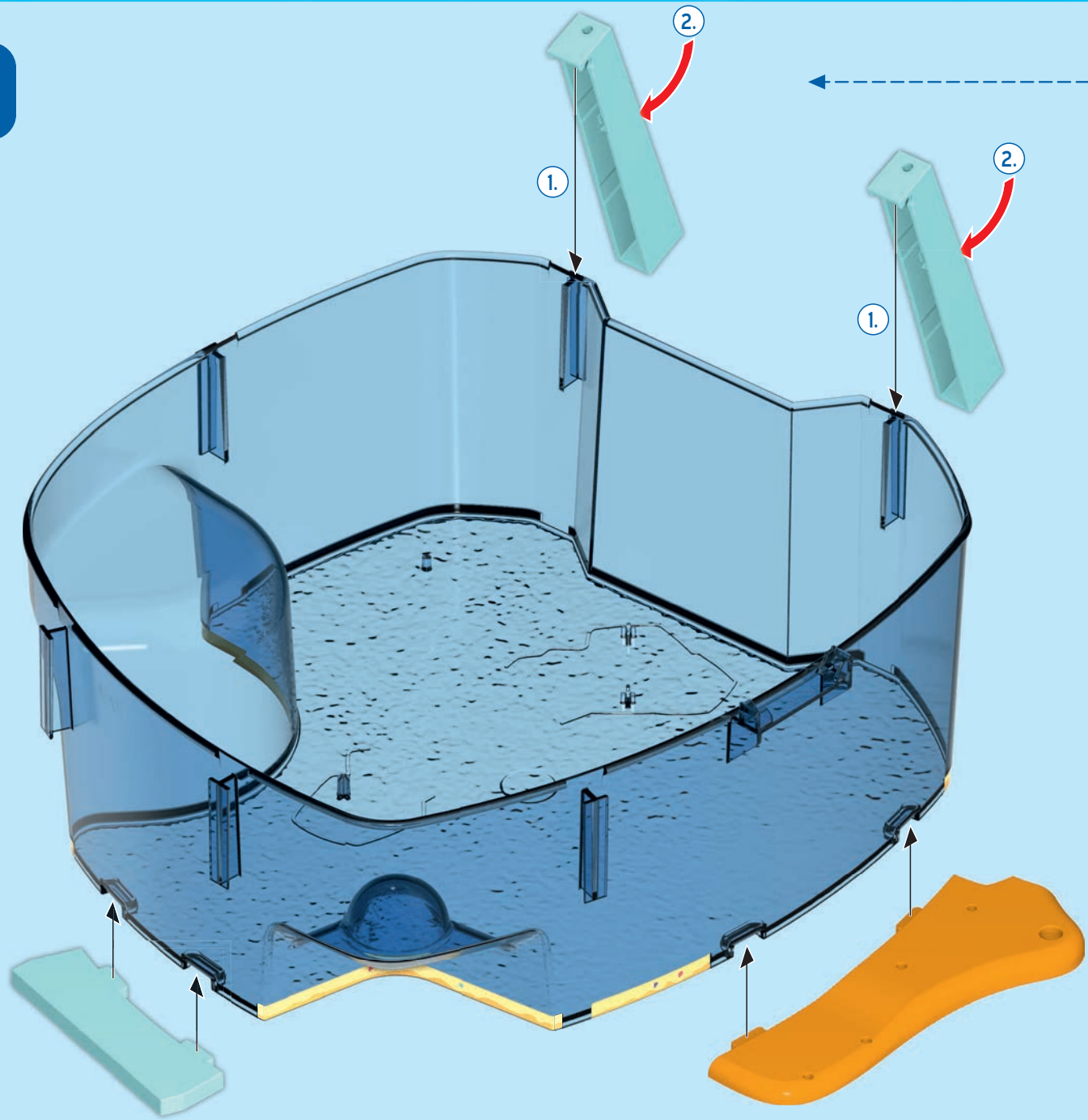

3

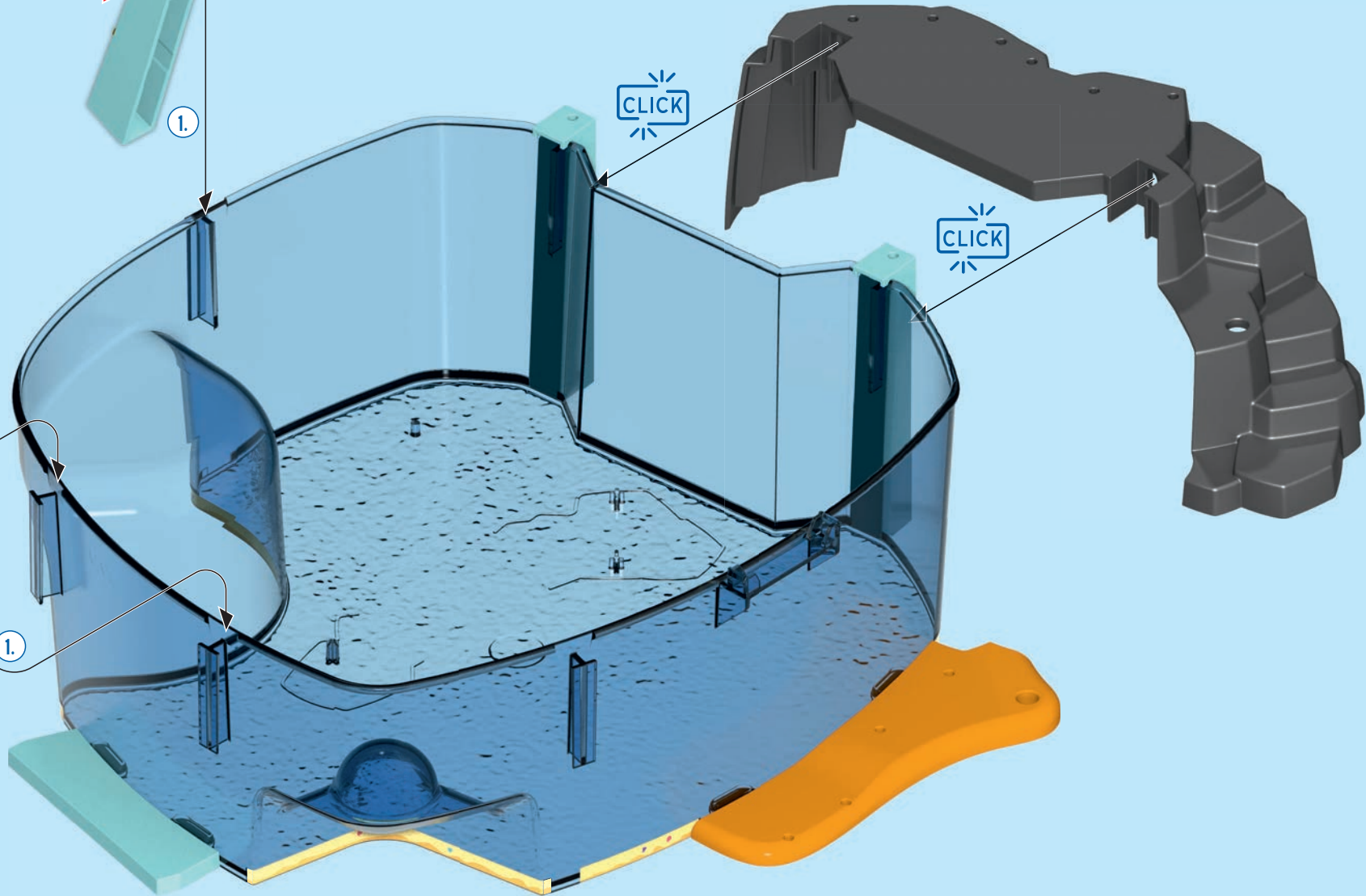
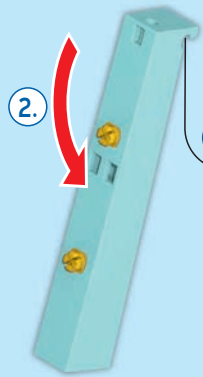
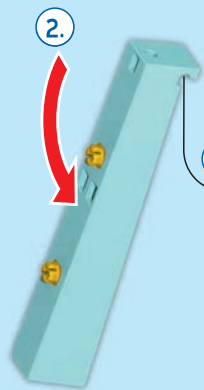
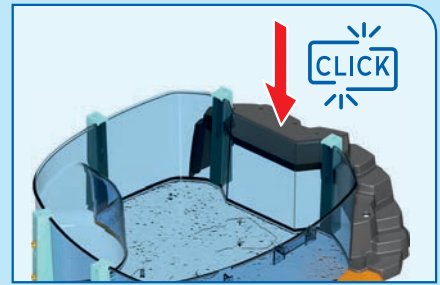
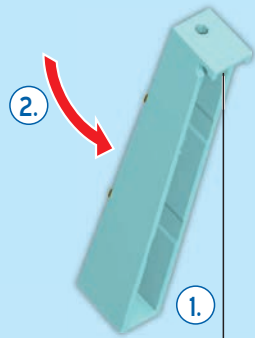
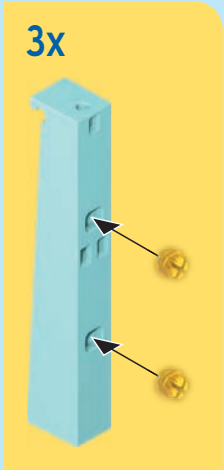



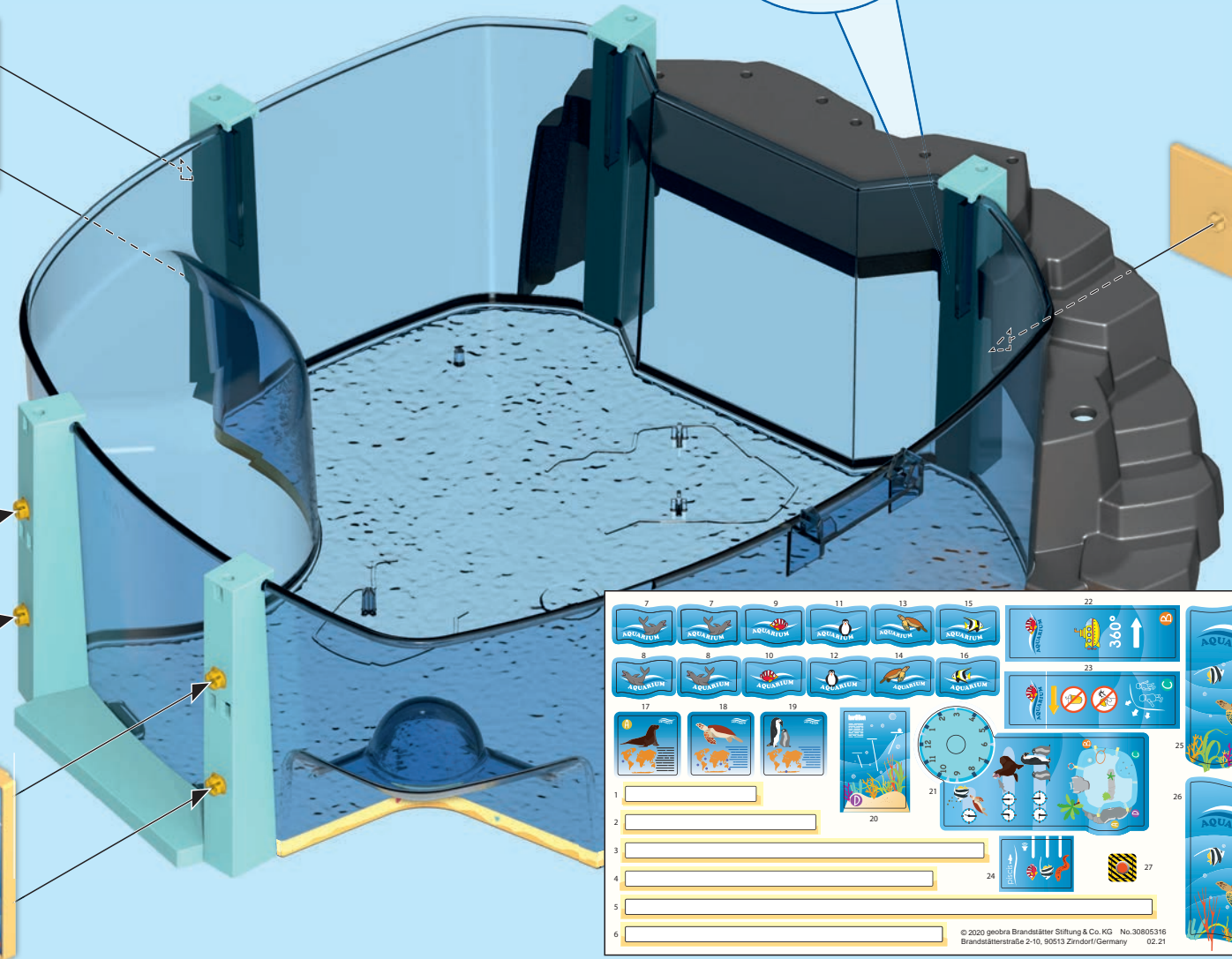
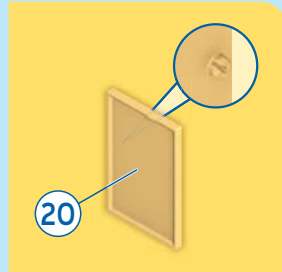
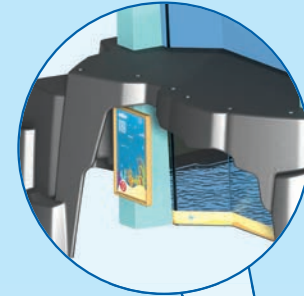
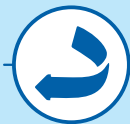
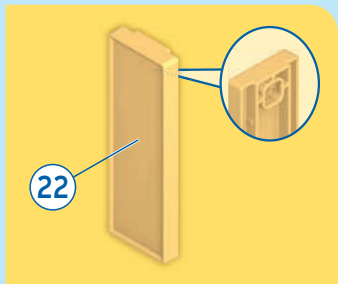
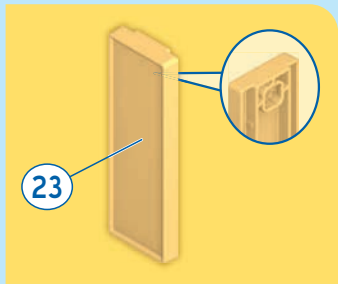
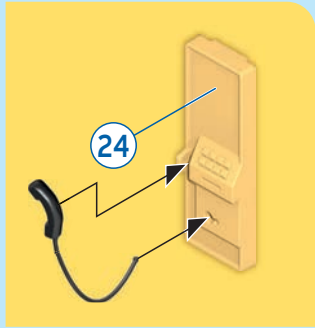

7	7	9	11	13	15	22	23	25
8	8	10	12	14	16			
17	18	19	20	21				
1	_____							
2	_____							
3	_____							
4	_____							
5	_____							
6	_____							

© 2020 geobra Brandstätter Stiftung & Co. KG No. 30805316  
Brandstätterstraße 2-10, 90513 Zirndorf/Germany 02.21

5

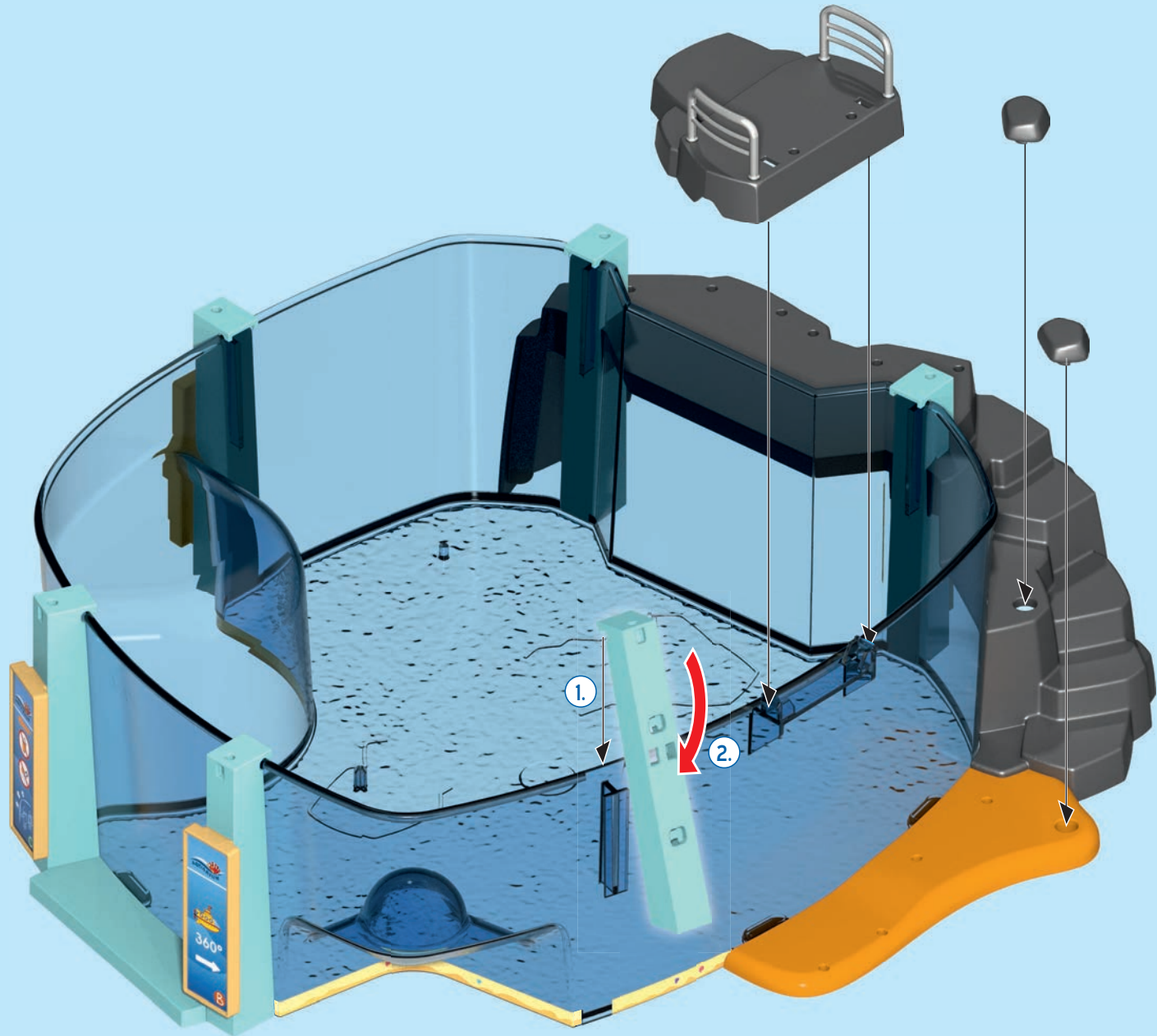
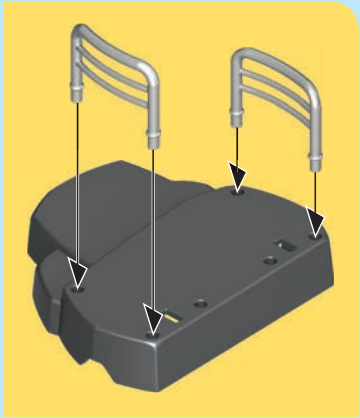



6

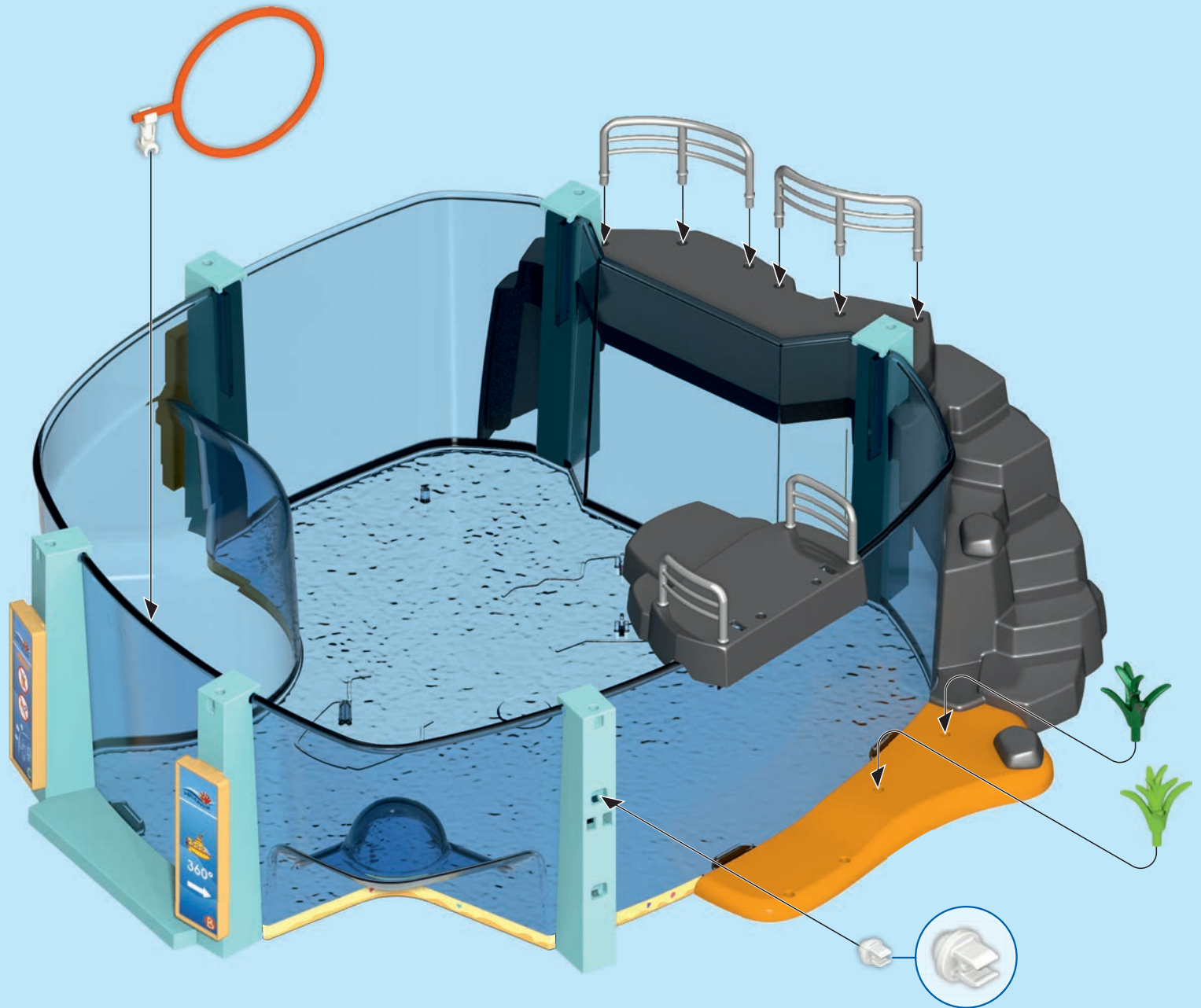
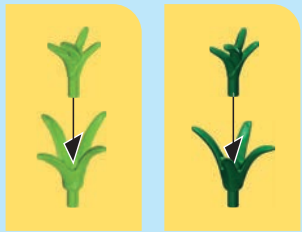
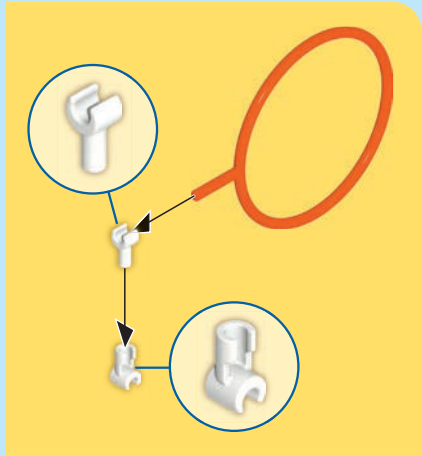

7

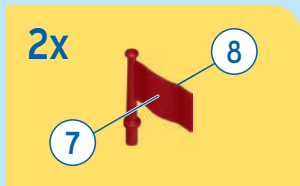
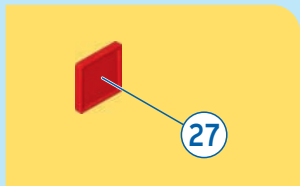
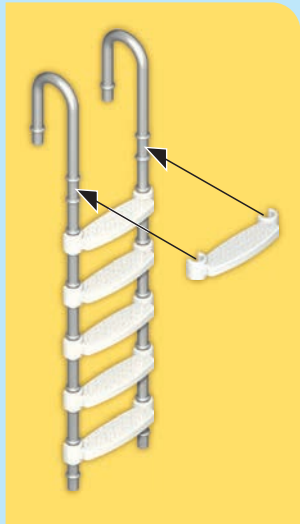

7	7	9	11	13	15	22	
8	8	10	12	14	16	23	
17	18	19				25	
1			20			26	
2							
3							
4							
5							
6							

© 2020 geobra Brandstätter Stiftung & Co. KG, No. 30805316  
Brandstätterstraße 2-10, 80513 Zirndorf, Germany 02-21

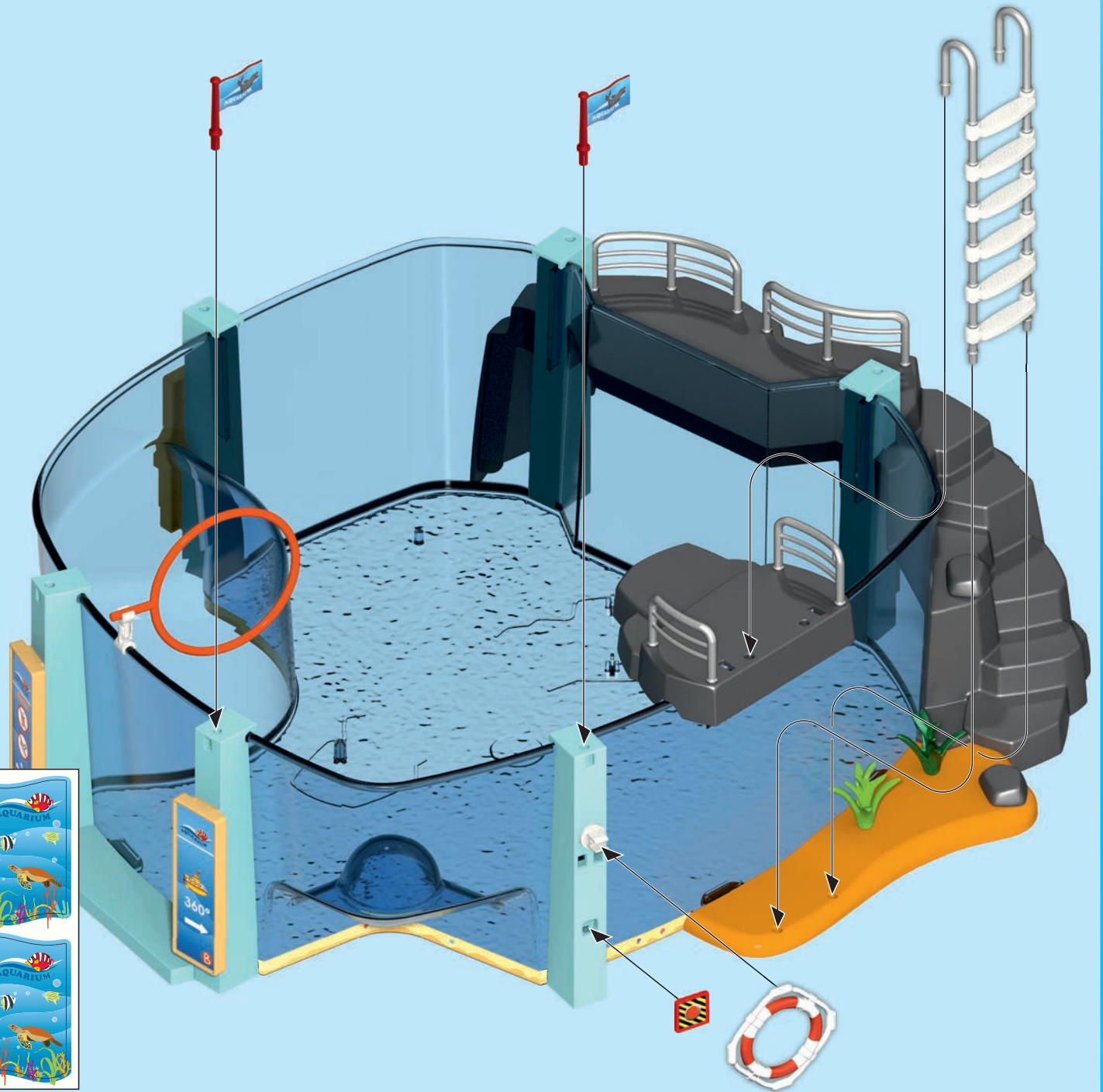





9

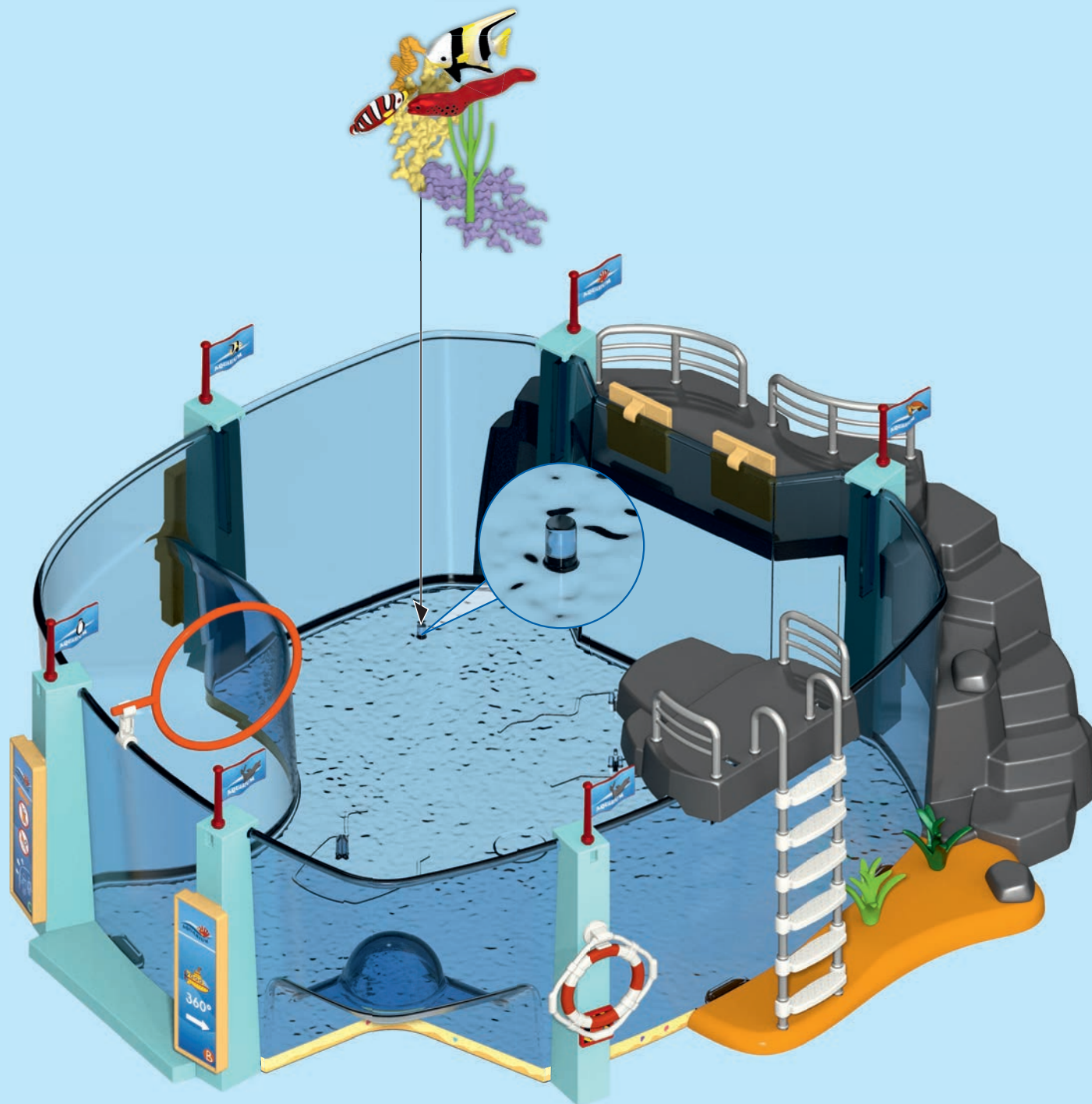
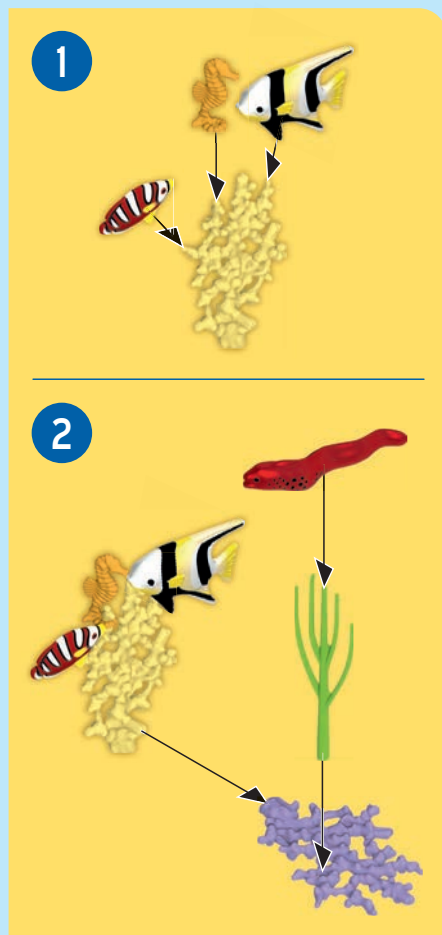



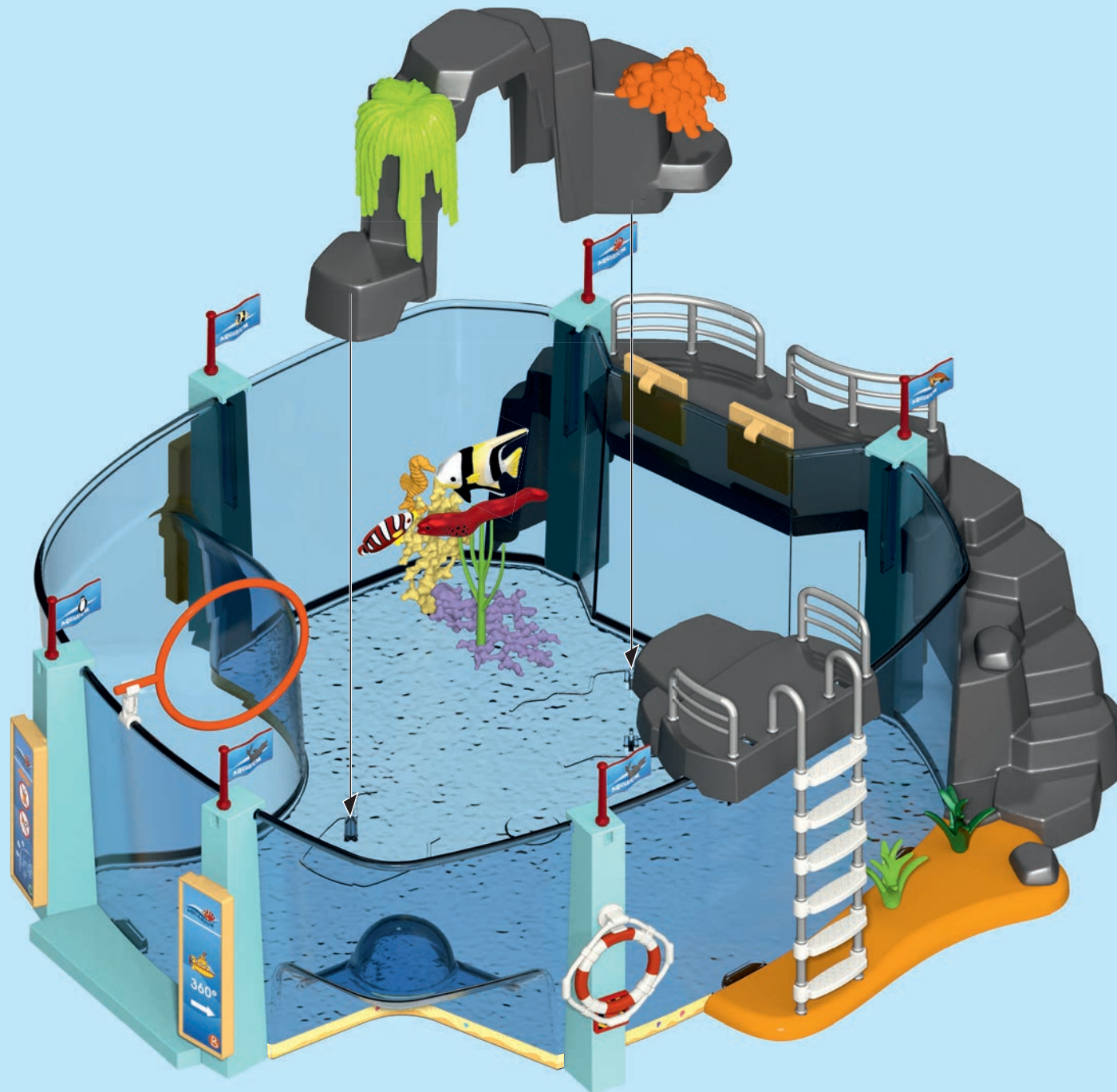

**DE AT CH LU BE** Nur Trinkwasser verwenden. Nach dem Spielen austrocknen lassen.

**US GB CA MT IE** Use only tap water. Dry thoroughly after play.

**FR CA BE LU CH** N'utiliser que de l'eau potable. Faire sécher après chaque utilisation.

**ES MX** Utilizar solamente agua potable. Dejar secar antes de guardar.

**NL BE** Enkel drinkbaar water gebruiken. Na het spelen laten drogen.

**IT CH** Usare solo acqua potabile. Asciugare bene dopo ogni uso.

**PT** Utilizar somente água potável. Deixar secar antes de guardar.

**DK** Anvend kun drikkevand. Lad det tørre ud når du er færdig med at lege.

**NO** Kun drikkevann skal benyttes. Tørk opp etter at leken er ferdig.

**SE FI** Använd endast dricksvatten. Låt torka efter användandet.

**FI** Käytä ainoastaan juomavettä. Anna kuivua leikin jälkeen.

**HU** Kérjük kizárólag ivóvizet használni! Játék után ajánlott a termék kiszáritása!

**CZ** Používat jen pitnou vodu. Po hraní nechat vyschnout.

**EE** Kasutada üksnes joogivett! Mängimise järel kuivatada!

**LV** Izmantot tikai dzeramo ūdeni. Pēc spēlēšanās ļaut nožūt.

**LT** Naudokite tik geriamąjį vandenį. Pažaidus, išdžiovinkite.

**SI** V igračo vlivajte le pitno vodo. Po igri naj se igrača posuši.

**SK** Používať iba pitnú vodu. Po hre nechať vyschnúť.

**PL** Używaj tylko wodę pitną. Po zabawie pozostaw do wyschnięcia.

**TR CY** Sadece içme suyu kullanınız. Oyundan sonra kurumaya bırakın.

**GR CY** Χρησιμοποιείτε μόνο νερό βρύσης. Μόλις τελειώσετε, αφήστε το παιχνίδι να στεγνώσει εντελώς.

**RO** Se folosește doar apă potabilă. După joacă se lasă să se usuce.

**BG** Използвайте само питейна вода. След игра оставете да изсъхне.

**HR** Koristiti samo pitku vodu. Poslije igranja pustiti da se osuši.

**RU** Используйте только питьевую воду. Дайте высохнуть после игры.

**CN** 仅使用饮用水。玩耍后要干燥。

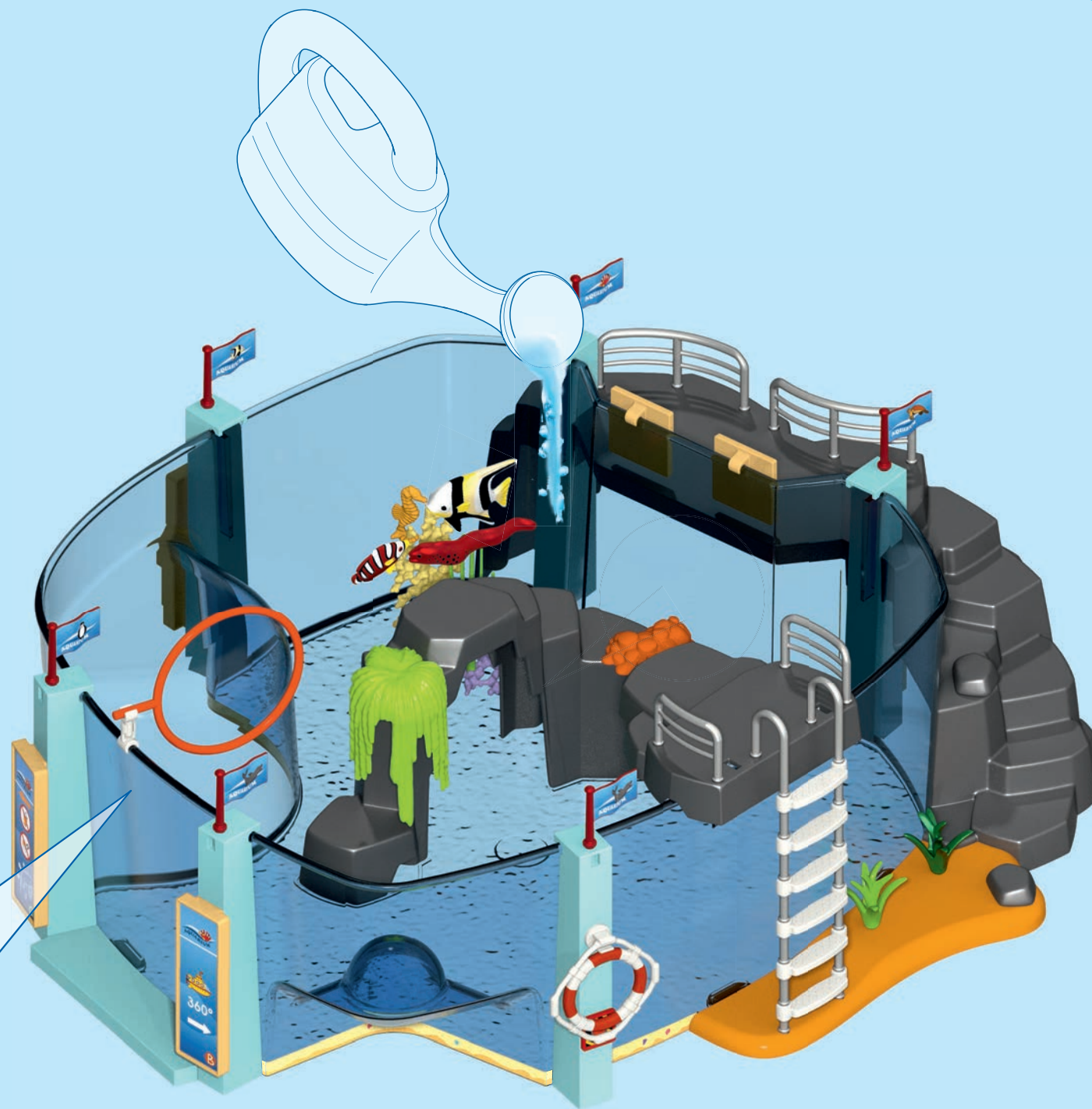



# 1

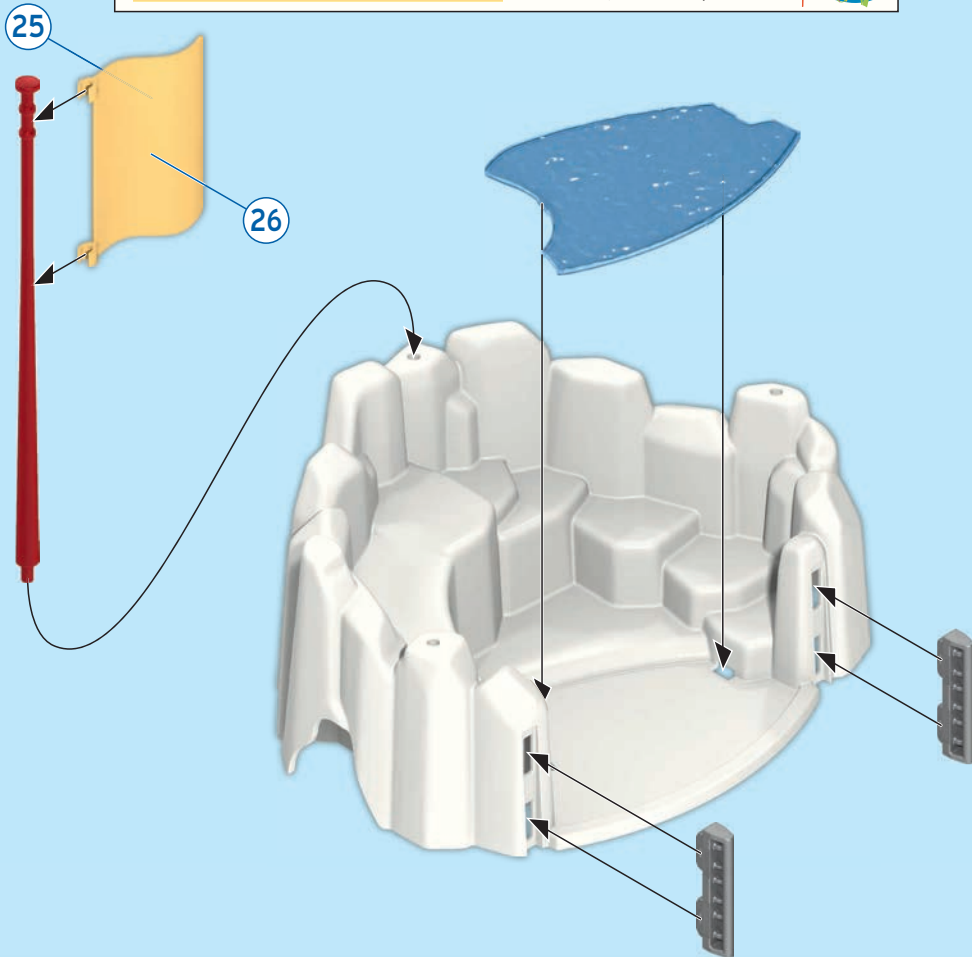
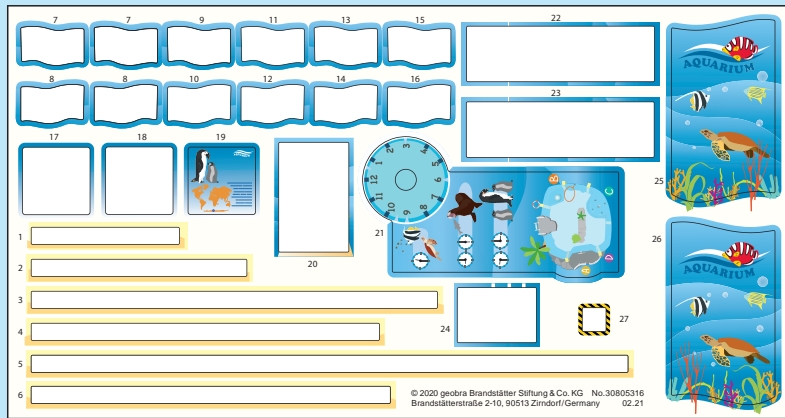

# 2

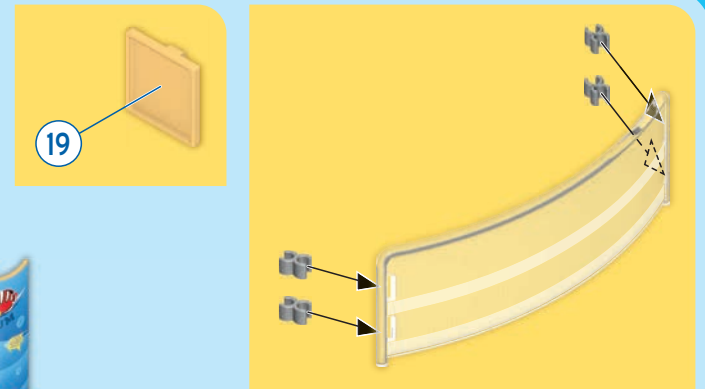

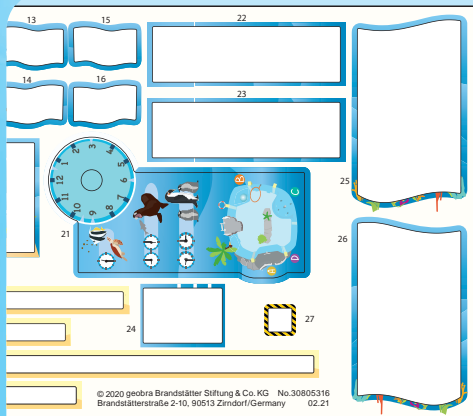

© 2020 geobra Brandstätter Stiftung & Co. KG  
 Brandstätterstraße 2-10, 90513 Zirndorf/Germany 02.21

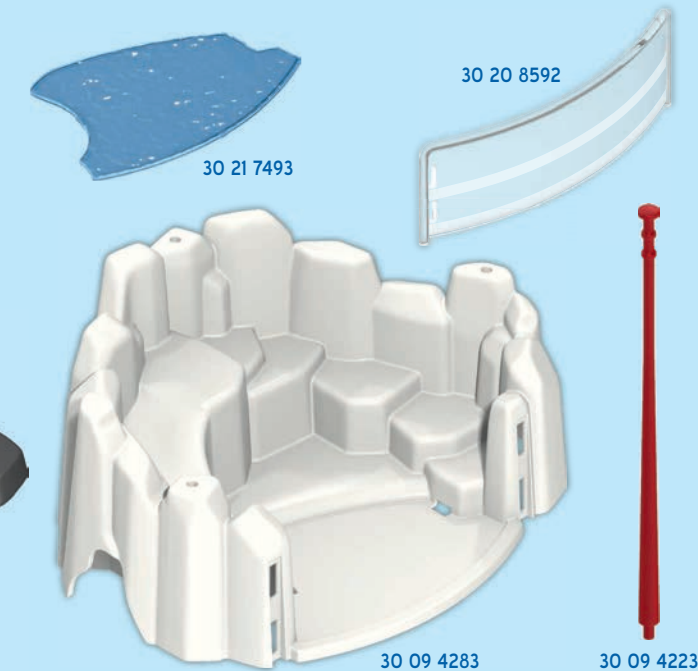
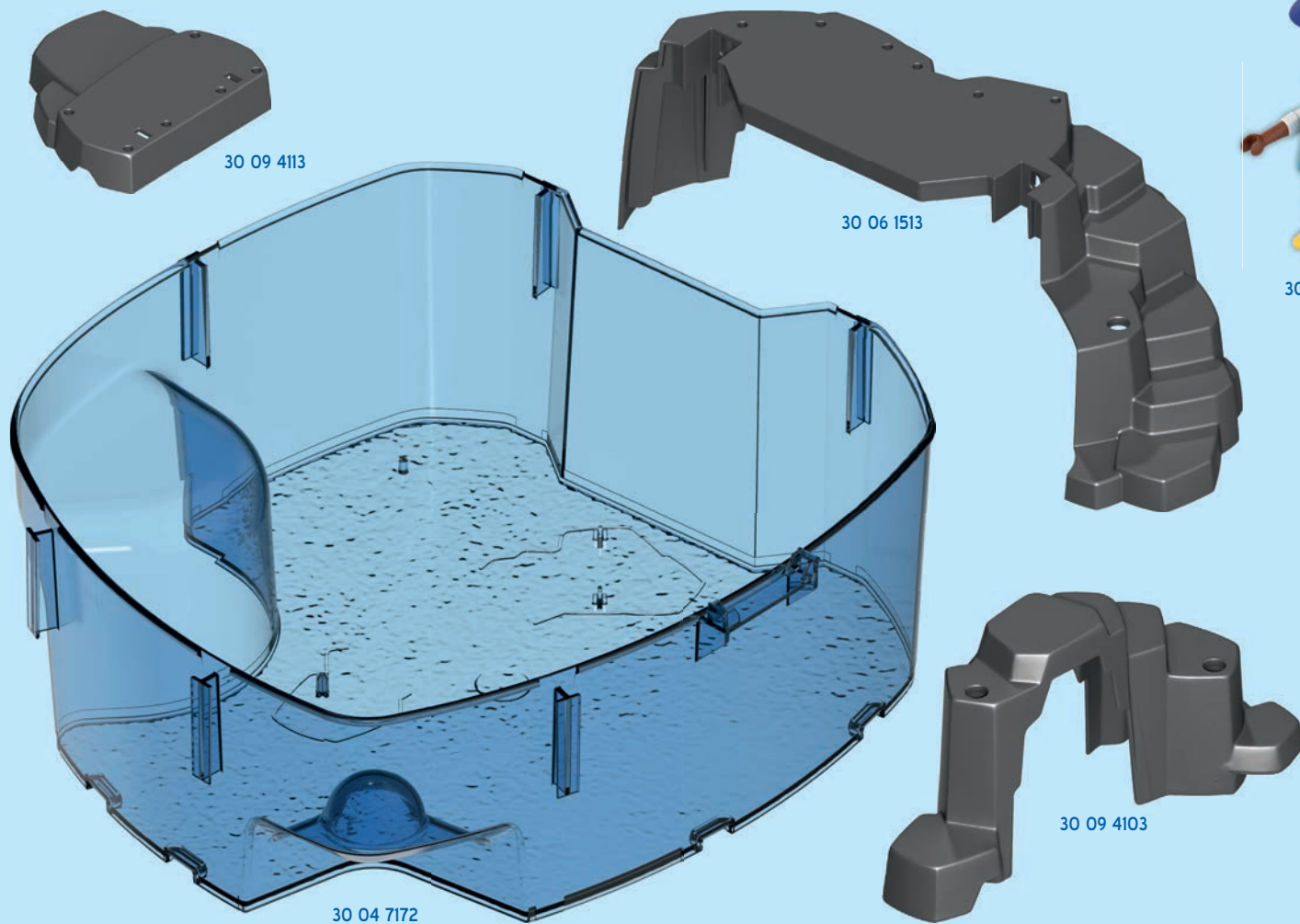
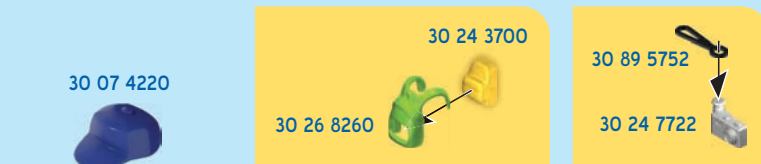
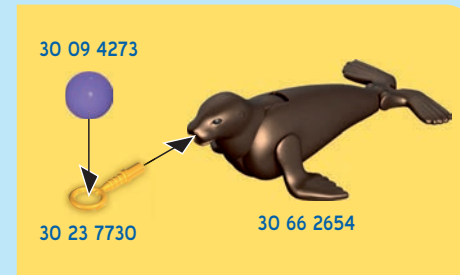
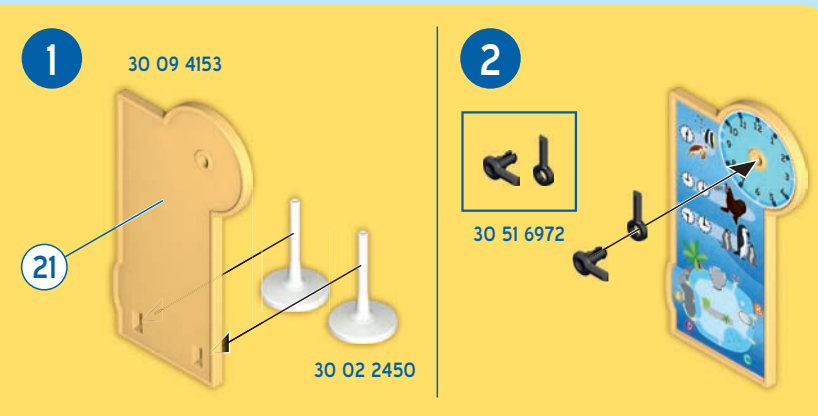





2x 30 09 4133

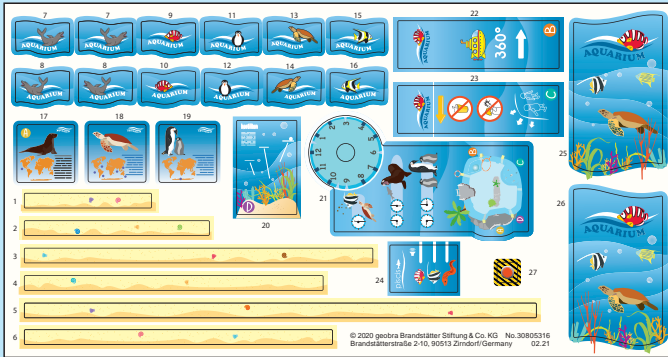

30 80 5316



6x 30 09 4213



30 04 7192



2x 30 09 4183



30 09 4173



30 09 4093

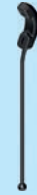

30 24 7172



30 09 4233



30 09 4243



30 22 0972



2x 30 09 4303



30 22 3510



30 09 4253



30 65 8822



30 09 4203



3x 30 09 4193



2x 30 09 4293

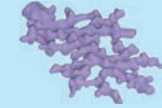

30 09 4263



30 02 6270



2x 30 09 4143



2x 30 09 4123



30 04 4720



30 66 2654



30 46 7330



30 46 7320



2x 30 46 3082



2x 30 46 3972



30 64 8500



30 66 2983



30 63 4860

30 06 5430



30 06 5420

30 27 4800



30 27 4790



30 21 9002



6x 30 03 6842



6x 30 25 0553



30 20 2262



2x 30 06 1523



30 09 4313



30 64 3512



30 09 6410



30 09 5550



30 25 1190



5x 30 22 6242



30 61 4630



30 60 6610



30 51 2422



30 04 7092



30 04 7102



30 21 0550



4x 30 27 1060



16x 30 03 6600



30 26 3080





70343



70355 70351 70350 70349 70353 70352



70342



70344



70346



70359



70354



70324



70345



70537



70341



Adresses sur [quefairemesdechets.fr](http://quefairemesdechets.fr)  
©2021 geobra Brandstätter Stiftung & Co. KG  
Brandstätterstr. 2-10 • 90513 Zirndorf, Germany • No. 30 82 4396 09.23