

playmobil®

HISTORY



70466



WARNING: CHOKING HAZARD

Small parts. Not for children under 3 years.

"Ne concerne que les USA"

Wichtige Unterlagen, bitte sorgfältig aufbewahren!
Important: Please keep these instructions for future reference!
Documents importants, à conserver soigneusement!
¡Por favor, guarde estas instrucciones para el futuro!
Belangrijke documenten, bewaar deze zorgvuldig!

Abbildungen können vom Original abweichen.
Product may differ from image shown.
Les illustrations peuvent différer de l'original.
Las ilustraciones pueden diferir del original.
Afbeeldingen kunnen verschillen van het werkelijke artikel.

1

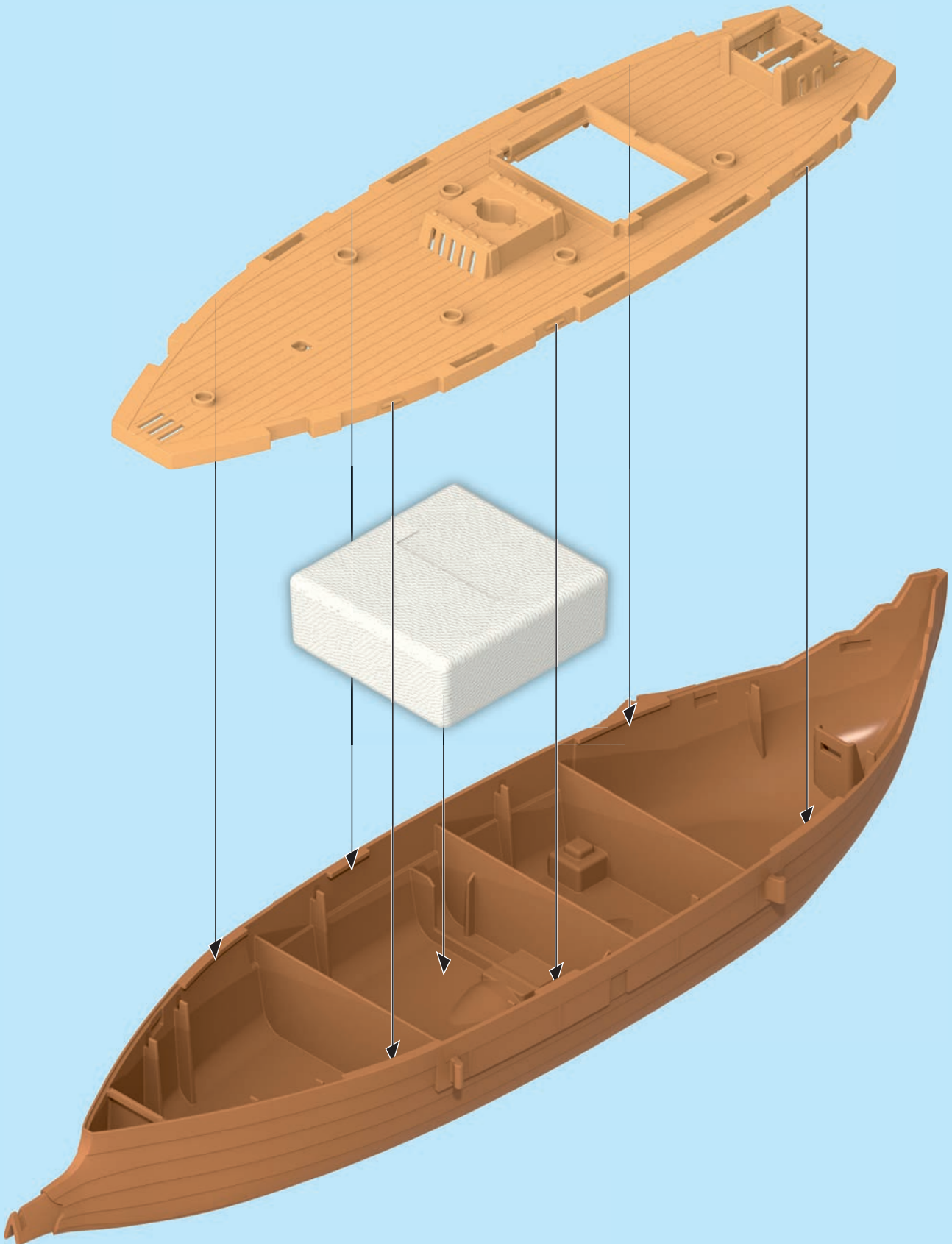

2

2x

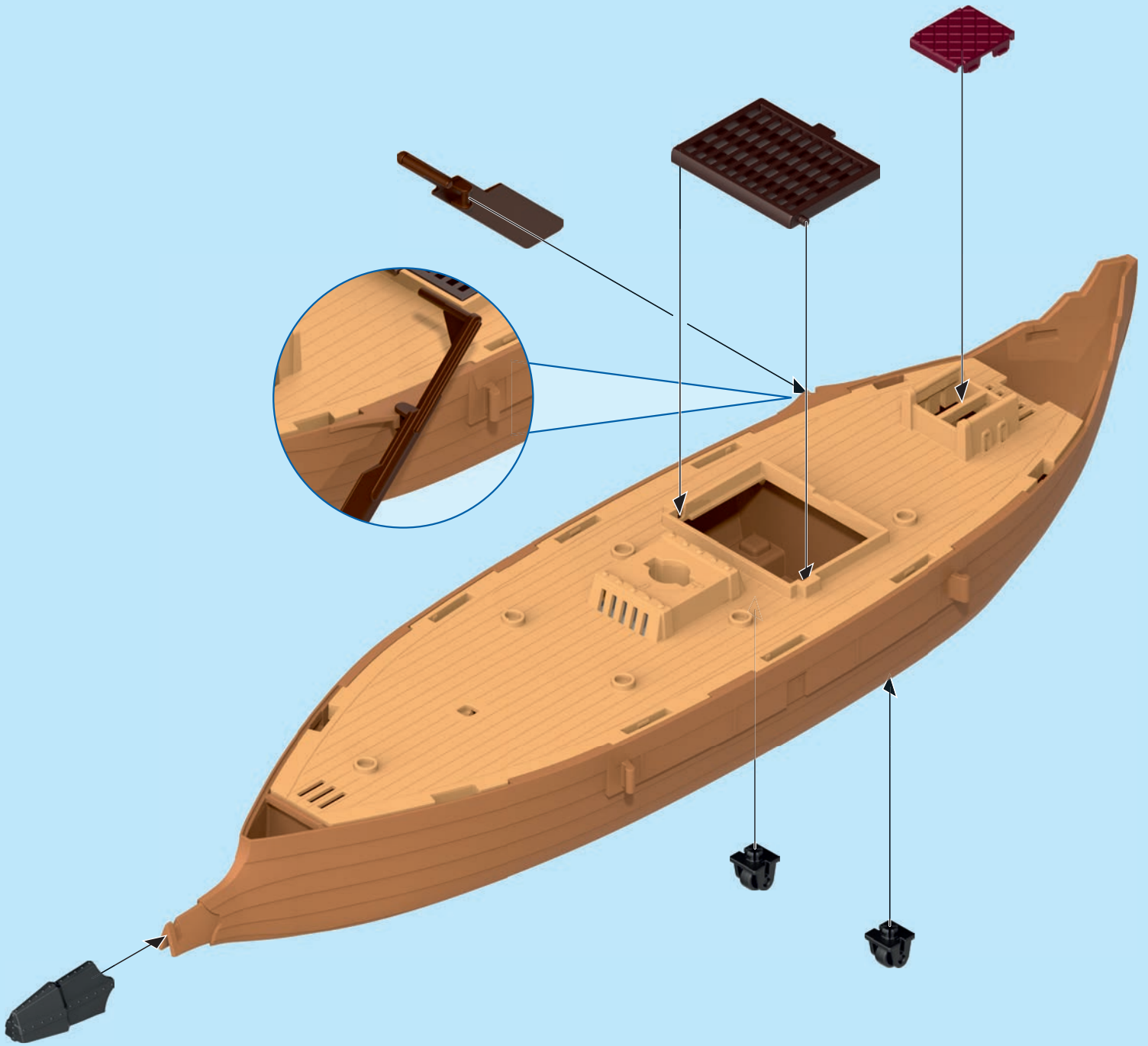

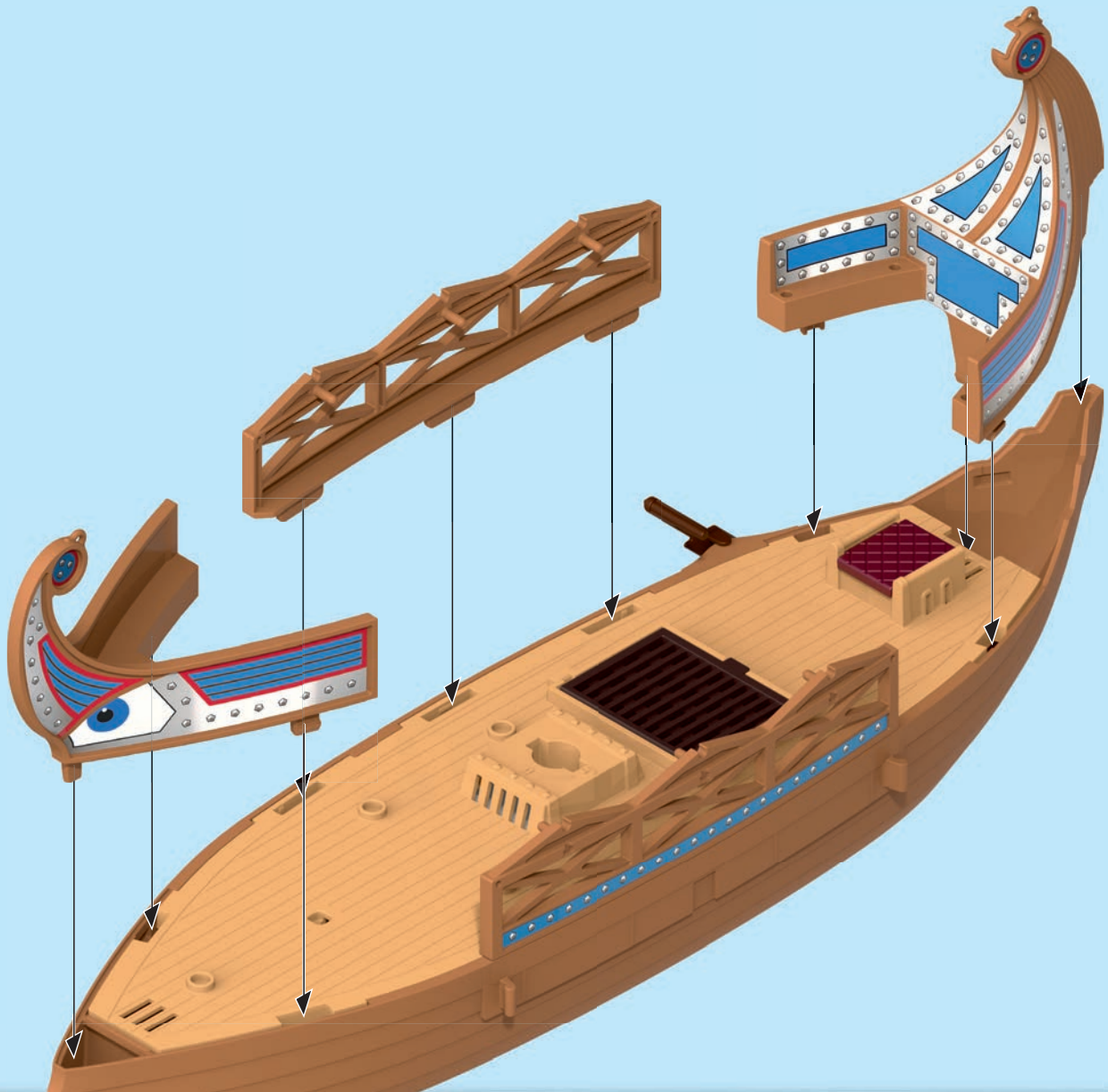
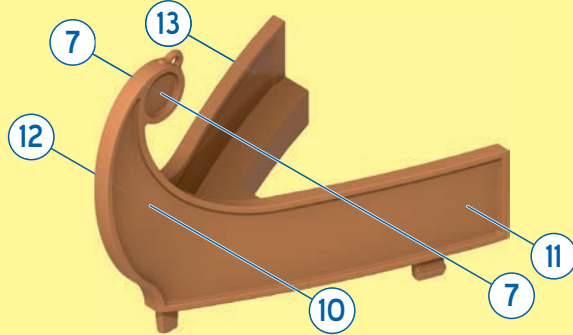
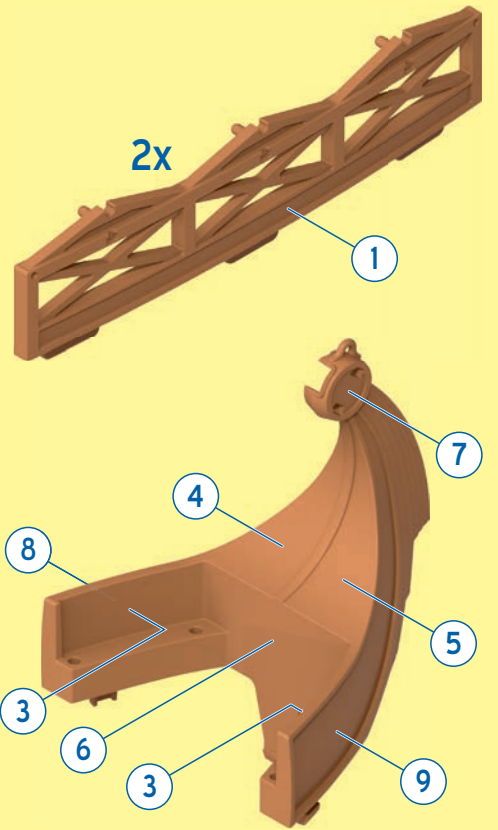
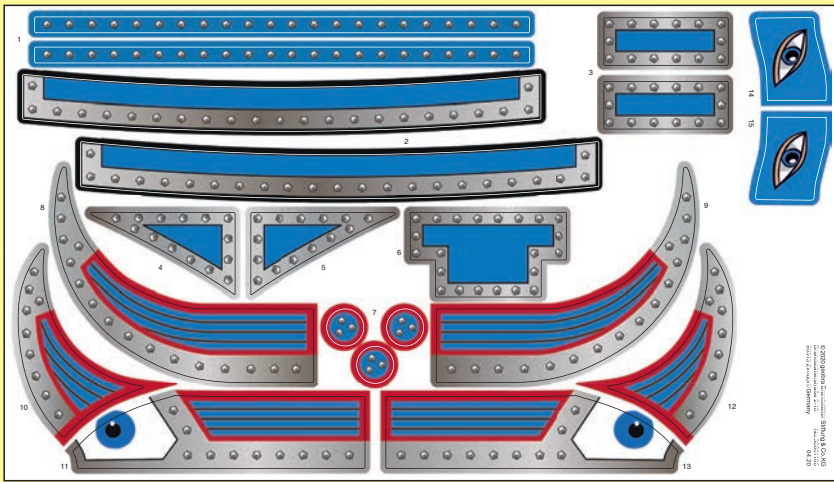

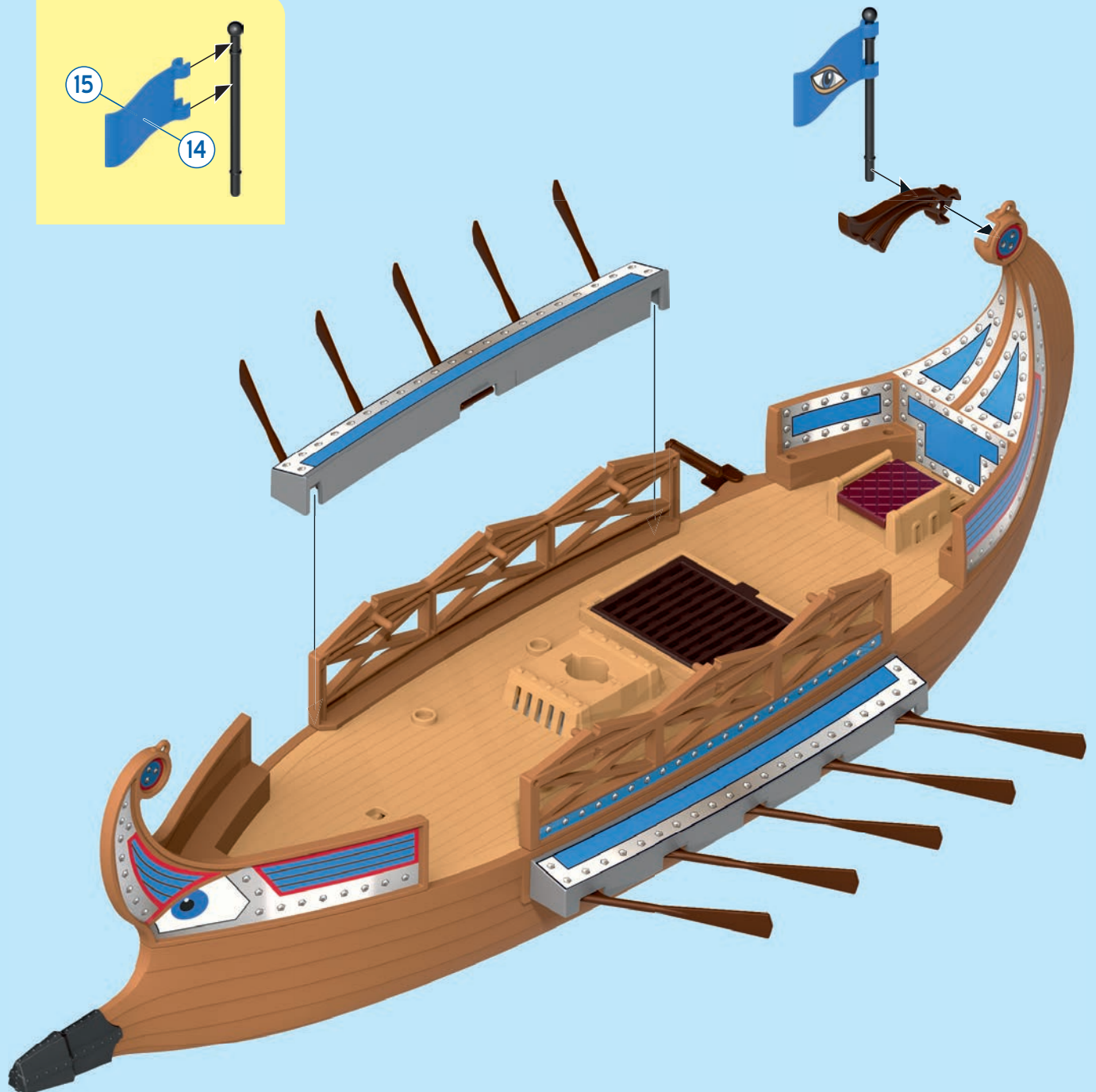
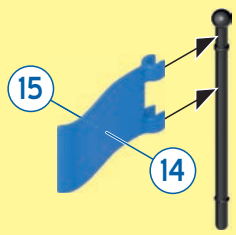
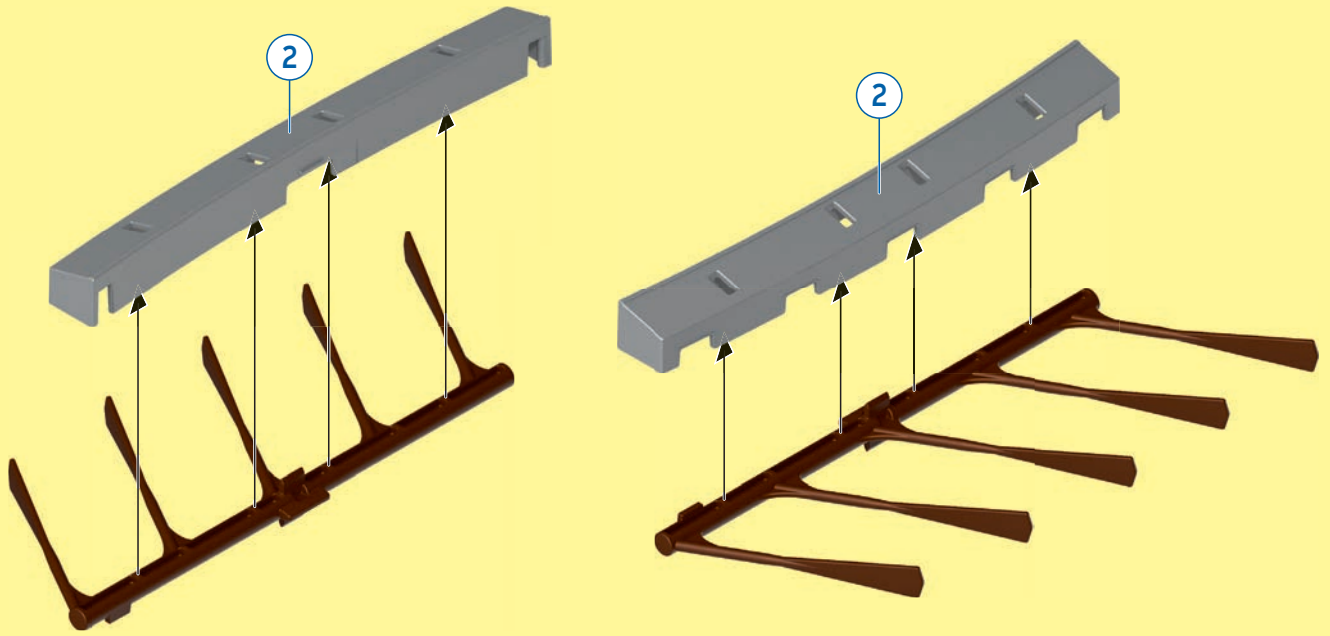

1

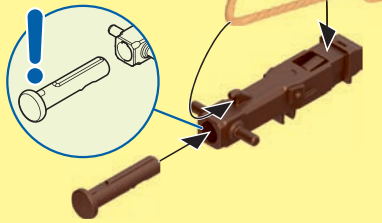

2

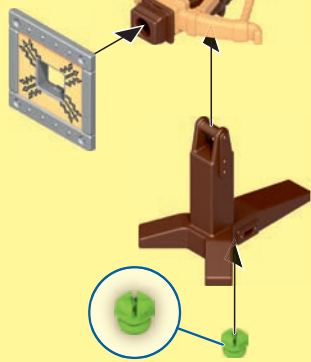

3

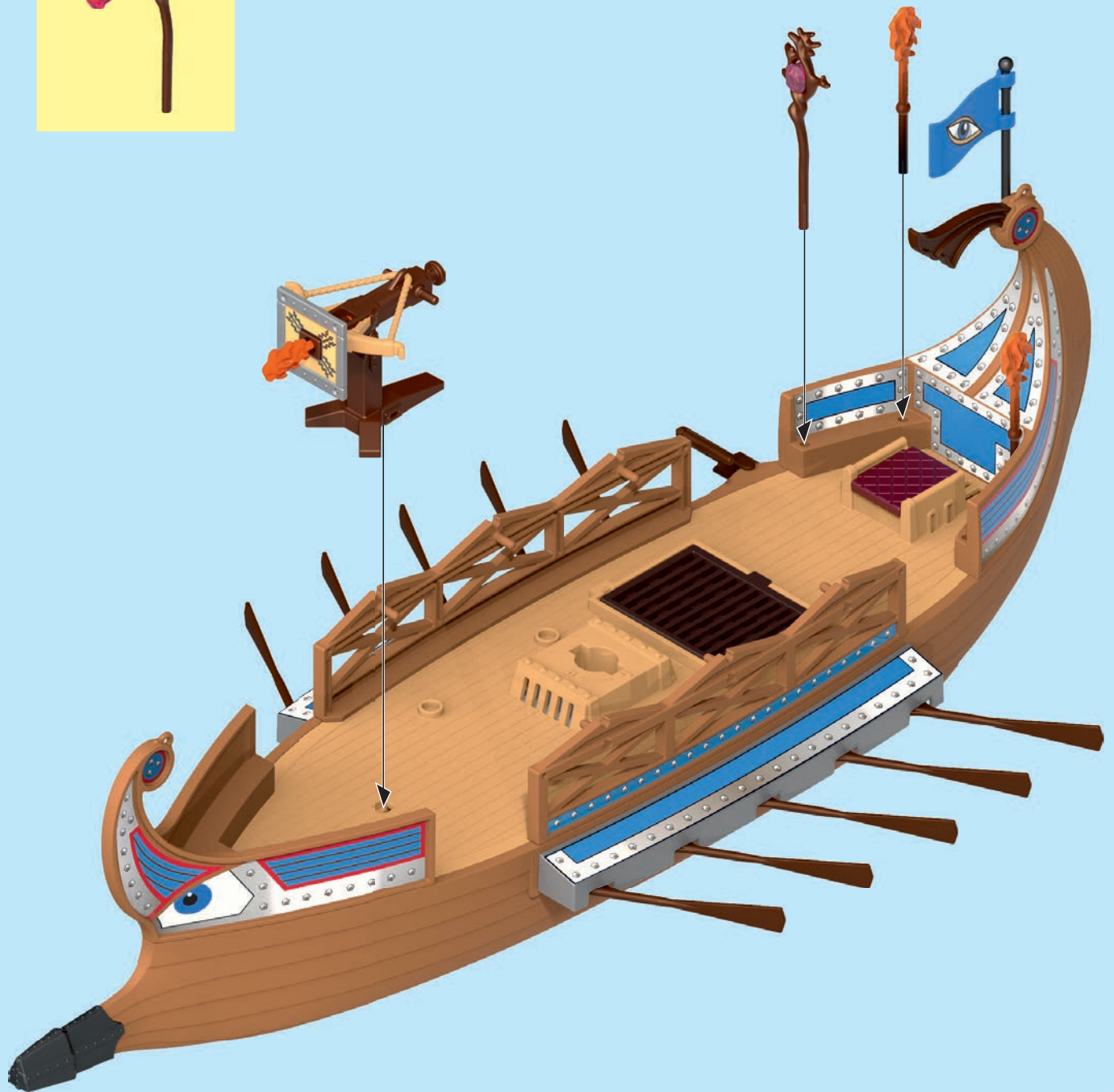
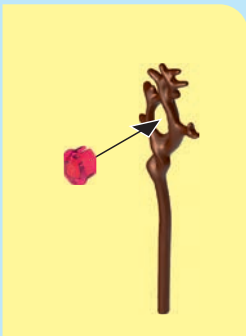
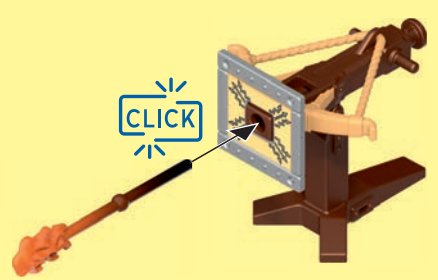

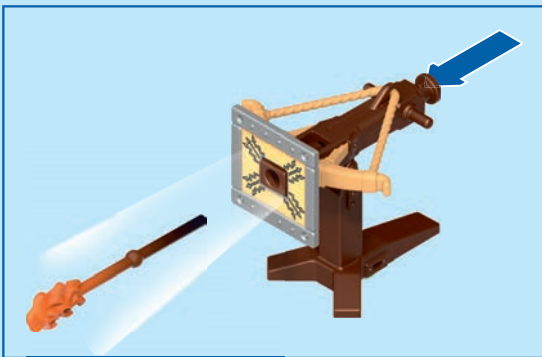

DE AT CH LU BE ACHTUNG!

- Nur im flachen Wasser unter Aufsicht von Erwachsenen verwenden. Nach dem Spielen austrocknen lassen.
- Nur mitgelieferte PLAYMOBIL Geschosse verwenden. Nicht auf Augen oder Gesicht zielen.

US GB CA MT IE WARNING!

- Only to be used in water in which the child is within its depth and under adult supervision. Dry thoroughly after play.
- Only use the PLAYMOBIL projectiles supplied. Do not aim at eyes or face.

FR CA BE LU CH ATTENTION!

- À n'utiliser qu'en eau où l'enfant a pied et sous la surveillance d'un adulte. Faire sécher après chaque utilisation.
- Seulement utiliser les projectiles PLAYMOBIL fournis. Ne pas viser les yeux ou le visage.

ES MX ¡ADVERTENCIA!

- Utilizar sólo en agua donde el niño pueda permanecer de pie y bajo vigilancia de un adulto. Dejar secar antes de guardar.
- Utiliza únicamente los proyectiles PLAYMOBIL suministrados. No apuntar a los ojos ni a la cara.

NL BE WAARSCHUWING!

- Gebruiken in water waar kinderen kunnen staan en onder toezicht van volwassenen. Na het spelen laten drogen.
- Uitsluitend meegeleverde PLAYMOBIL delen gebruiken. Niet op ogen of gezicht richten.

IT CH AVVERTENZA!

- Da utilizzare unicamente in acqua dove il bambino tocca il fondo con i piedi e sotto la sorveglianza di un adulto. Asciugare bene dopo ogni uso.
- Usare soltanto i proiettili PLAYMOBIL in dotazione. Non mirare agli occhi o al viso.

PT ATENÇÃO!

- Só utilizar em água onde a criança tenha pé e sob vigilância de adultos. Deixar secar antes de guardar.
- Usar apenas os projecteis PLAYMOBIL juntamente fornecidos. Não apontar para os olhos ou face.

DK ADVARSEL!

- Må kun anvendes under opsyn af en voksen og på vanddybder, hvor barnet kan bunde. Lad det tørre ud når du er færdig med at lege.
- Anvend kun de medfølgende PLAYMOBIL projektiler. Sigt ikke mod øjne eller ansigt.

NO ADVARSEL!

- Skal kun brukes i vann som ikke er for dypt for barnet, og der barnet er under tilsyn. Tørk opp etter at leken er ferdig.
- Benytt kun PLAYMOBIL prosjektil som leveres med. Sikt ikke på ansikt eller øyne.

SE FI WARNING!

- Får endast användas i vatten där barnet bottnar och under tillsyn av en vuxen. Låt torka efter användandet.
- Använd endast medleverade PLAYMOBIL-skott. Sikta inte mot ögon eller ansikte.

FI VAROITUS!

- Lelua saa käyttää vain aikuisen valvonnassa vedessä, jossa lapsi ylettyy pohjaan. Anna kuivua leikin jälkeen.
- Käytä vain mukana toimitettuja PLAYMOBIL-ammuksia. Ei saa kohdistaa suoraan silmiin tai kasvoihin.

HU FIGYELMEZTETÉS.

- Csak a gyermek magasságához képest biztonságos sekély vízben és felnőtt felügyelete mellett szabad használni! Játék után ajánlott a termék kiszáritása!
- Csak a csomagban található PLAYMOBIL lövedékeket szabad használni. Tilos szemre vagy arcra célozni.

CZ UPOZORNĚNÍ!

- Používat pouze ve vodě takové hloubky, kde dítě stačí, a pouze pod dohledem dospělé osoby. Po hraní nechat vyschnout.
- Používejte pouze střely PLAYMOBIL, které jsou součástí dodávky. Nemířte na oči nebo na obličej!

EE HOIATUS!

- Kasutada ainult täiskasvanu järelevalve all vees, kus laps ulatub jalgaodega põhja. Mängimise järel kuivatada!
- Kasutage ainult kaasaantud PLAYMOBIL'i laskemoona. Ära sihi silmadesse ega näkku.

LV BRĪDINĀJUMS!

- Lietot tikai sekļā ūdenī un pieaugušo uzraudzībā. Pēc spēlēšanās ļaut nožūt.
- Izmantot tikai PLAYMOBIL piegādes komplektā iekļautos šāviņus. Nevērst pret acīm vai seju.

LT ĮSPĖJIMAS!

- Naudoti tik vaikui tinkamame gylyje ir prižiūrint suaugusiesiems. Pažaidus, išdžiovinkite.
- Naudokite tik pridėdamus PLAYMOBIL šaudmenis. Netaikyti į akis arba veidą.

SI OPOZORILO!

- Uporabljajte samo v vodi, primerno plitvi za otroka in pod nadzorom odrasle osebe. Po igri naj se igrača posuši.
- Uporabljajte le priložene PLAYMOBIL-ove krogle. Ne merite v oči ali obraz.

SK UPOZORNENIE!

- Používať len vo vode, v ktorej dieťa dočiahne na dno, a pod dohľadom dospelých osoby. Po hre nechať vyschnúť.
- Používajte len náboje dodávané spolu so sadou PLAYMOBIL. Nemierť do očí alebo do tváre.

PL OSTRZEŻENIE!

- Do używania jedynie w wodzie na głębokości, na której dziecko wyczuwa dno pod nogami oraz pod nadzorem osoby dorosłej. Po zabawie pozostaw do wyschnięcia.
- Stosować tylko załączone PLAYMOBIL - kule / pociski. Nie celować w oczy i twarz.

TR CY DİKKAT!

- Sadece denetim altında ve sadece alçak sularda kullanın. Oyundan sonra kurumaya bırakın.
- Sadece birlikte verilen PLAYMOBIL mermileri kullanınız. Göze veya yüze doğru tutmayın.

GR CY Προειδοποίηση!

- Να χρησιμοποιείται μόνο σε νερά όπου πατώνει το παιδί και υπό την επίβλεψη ενήλικου. Μόλις τελειώσετε, αφήστε το παιχνίδι να στεγνώσει εντελώς.
- Να χρησιμοποιούνται αποκλειστικά τα βλήματα της PLAYMOBIL που περιέχονται στη συσκευασία. Μη μην γίνεται στόχευση στα μάτια ή στο πρόσωπο.

RO AVERTISMENT!

- A se utiliza numai acolo unde copilul poate sta în picioare în apă și este sub supraveghere. După joacă se lasă să se usuce.
- Se folosesc doar proiectilele incluse PLAYMOBIL. Nu se țintește în ochi sau în față.

BG Внимание!

- Да се използва само във вода, която е дълбока до нормалния ръст на детето, и под надзора на възрастен. След игра оставете да изсъхне.
- Използвайте само приложени PLAYMOBIL снаряди. Не насочвайте към очите и лицето.

HR UPOZORENJE!

- Koristiti samo u plitkoj vodi pod nadzorom odraslih. Poslije igranja pustiti da se osuši.
- Upotrijebiti samo od strane PLAYMOBIL-a isporučene projekte. Ne ciljati u oči ili lice.

CN 警告!

- 仅供儿童在成人监护下在浅水中使用。玩具玩后请拭干。
- 仅能用PLAYMOBIL的炮弹，请勿瞄准眼睛或脸。(说明书上含有重要信息，请保留备用)

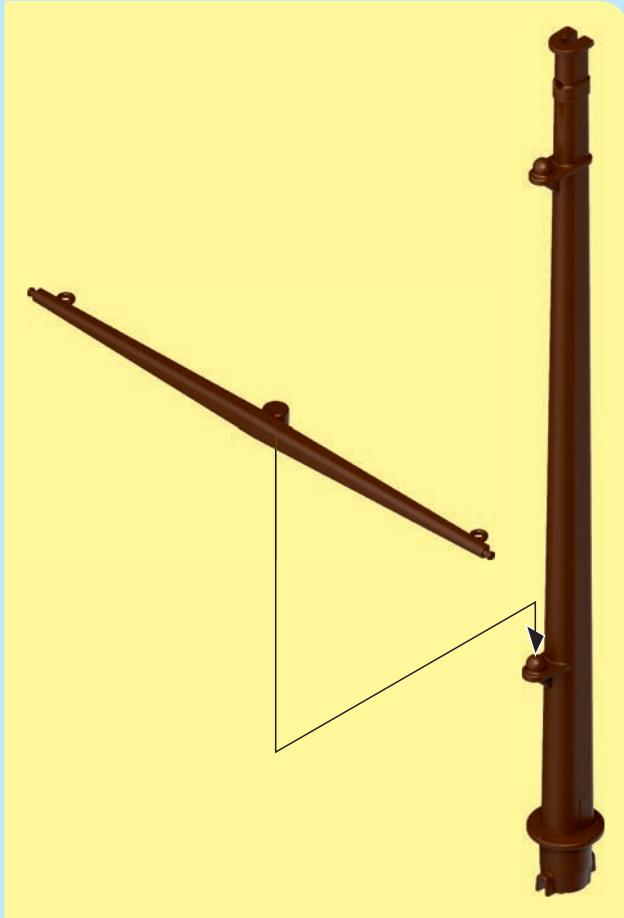

cm	0	1	2	3	4	5	6	7	8	9	10	11	12	13	14	15
inch	0		1		2		3		4		5		6			

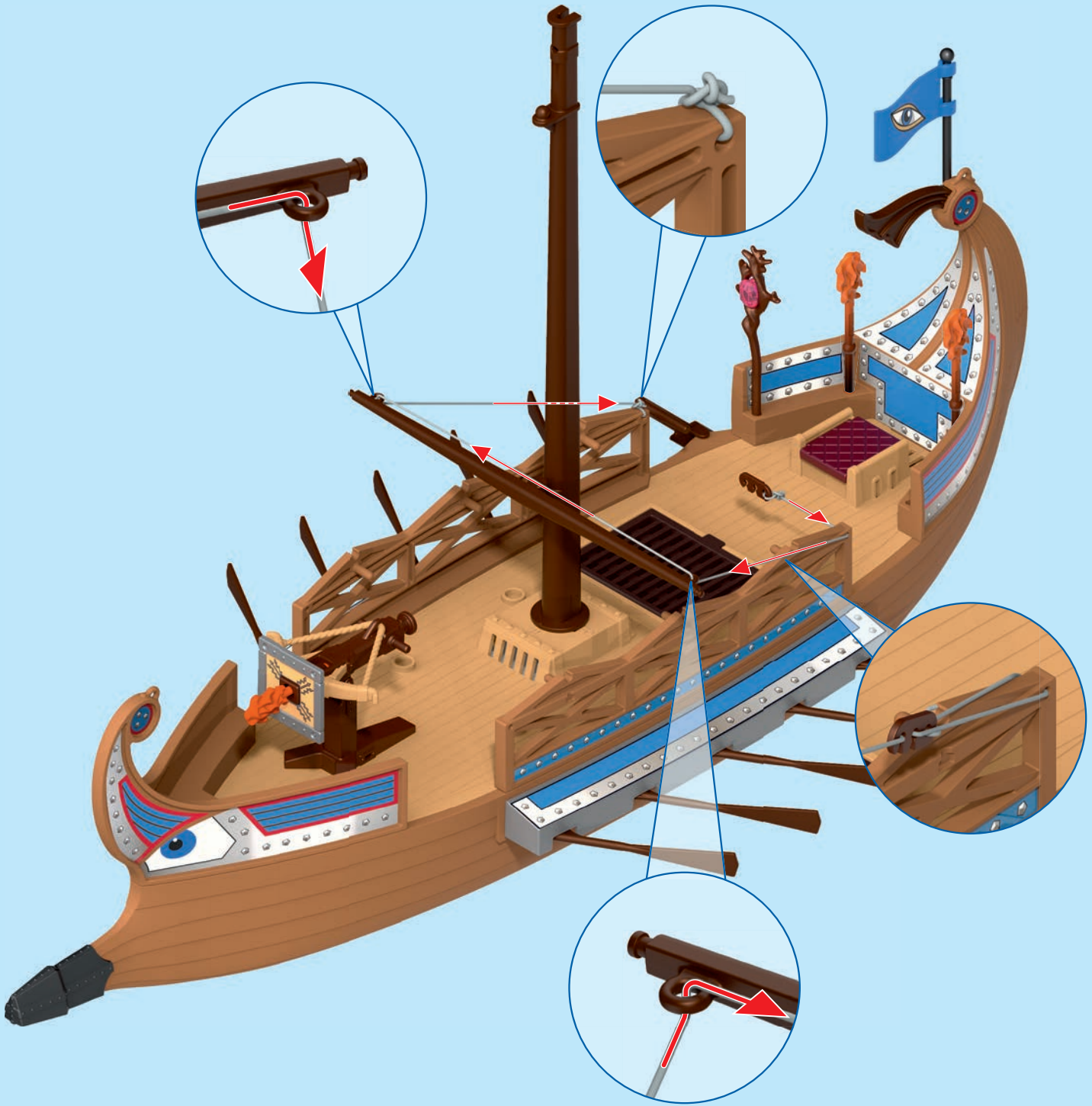
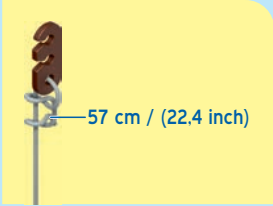

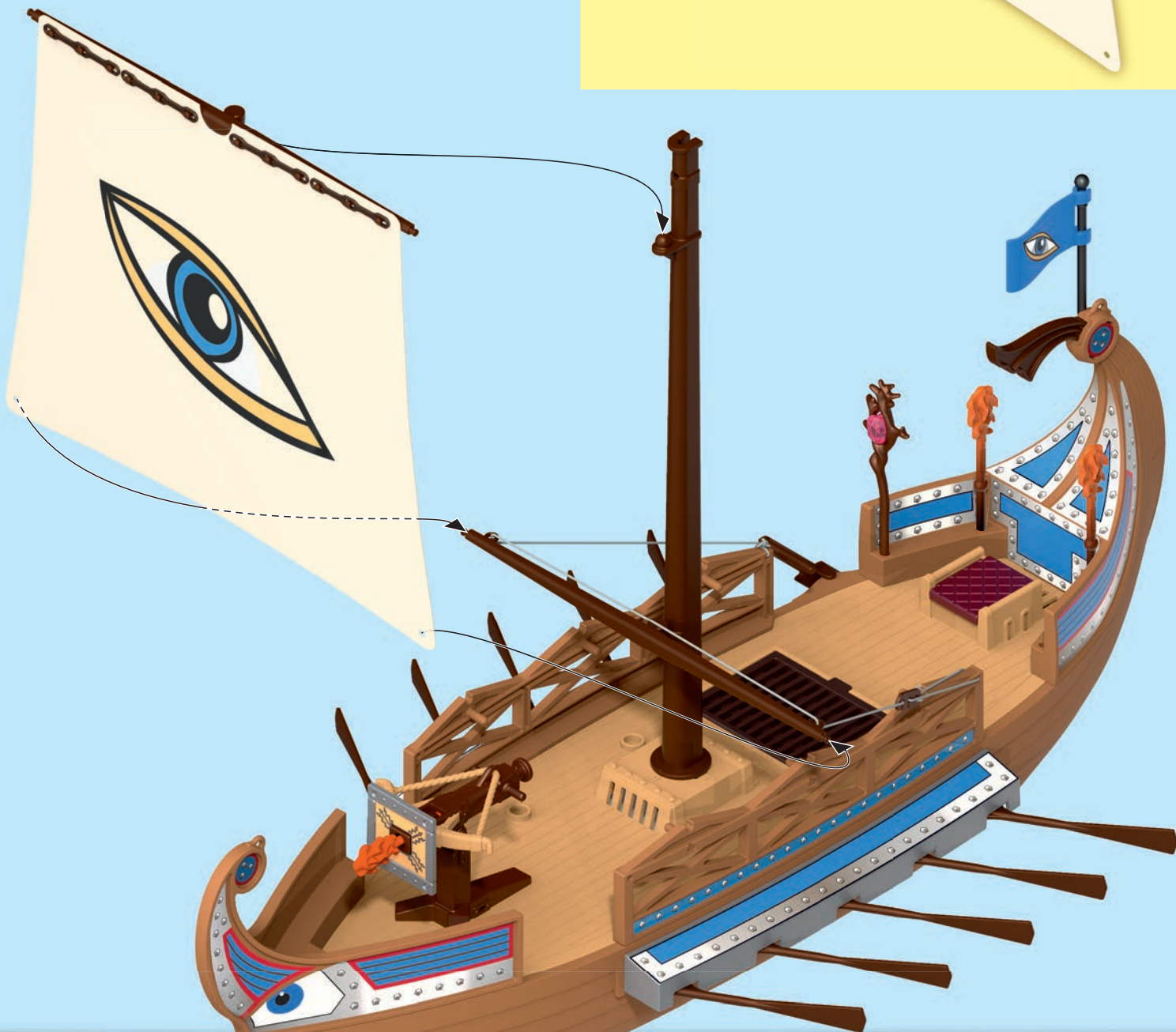
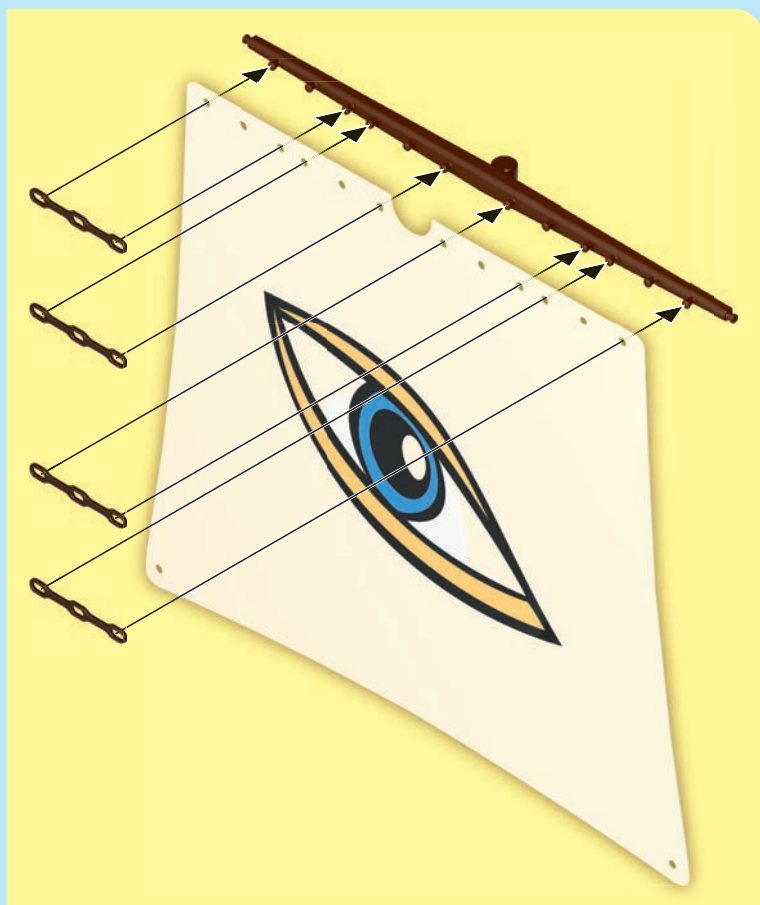

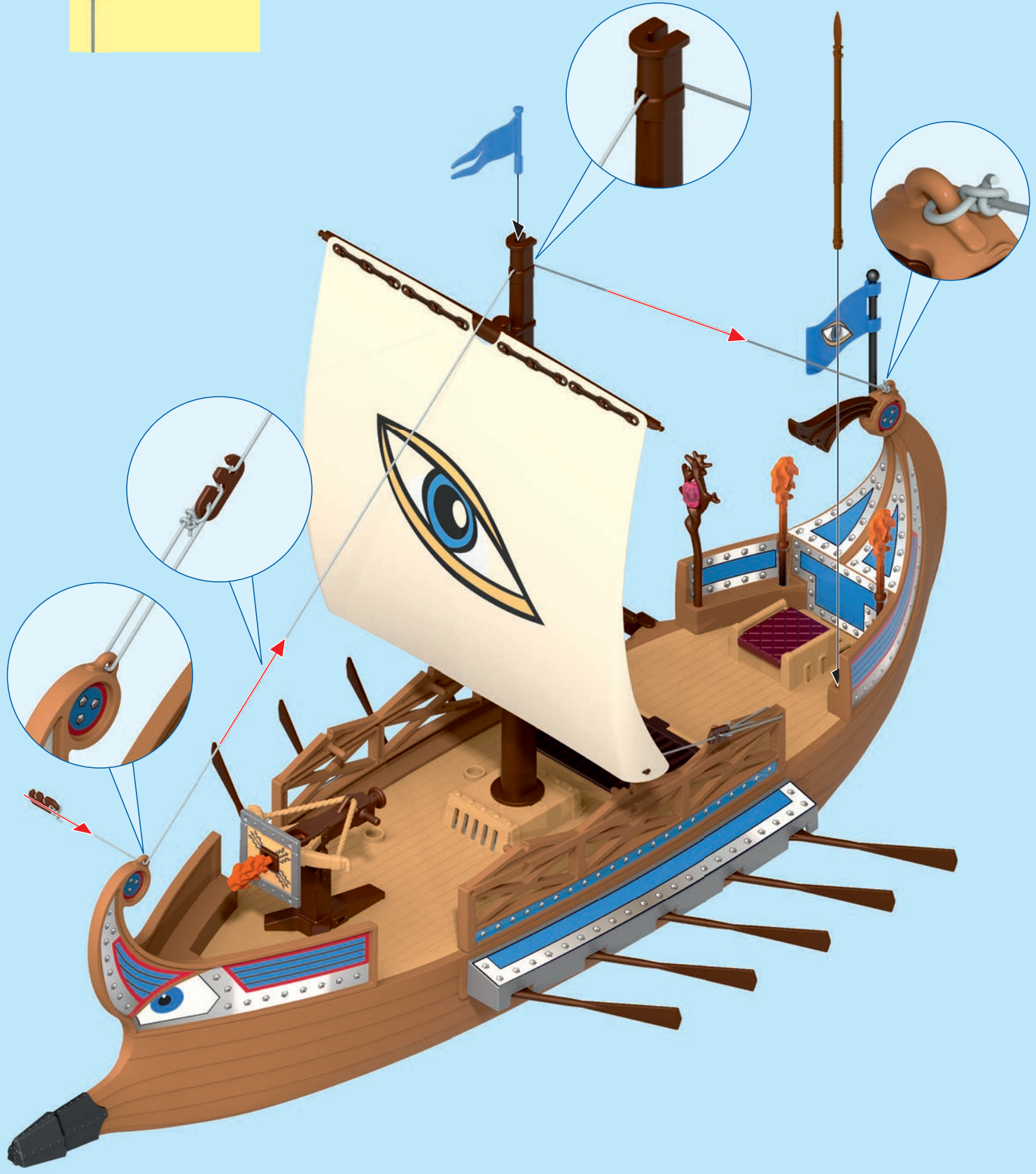
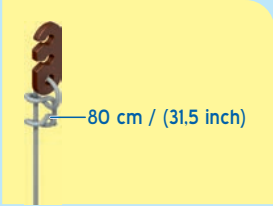

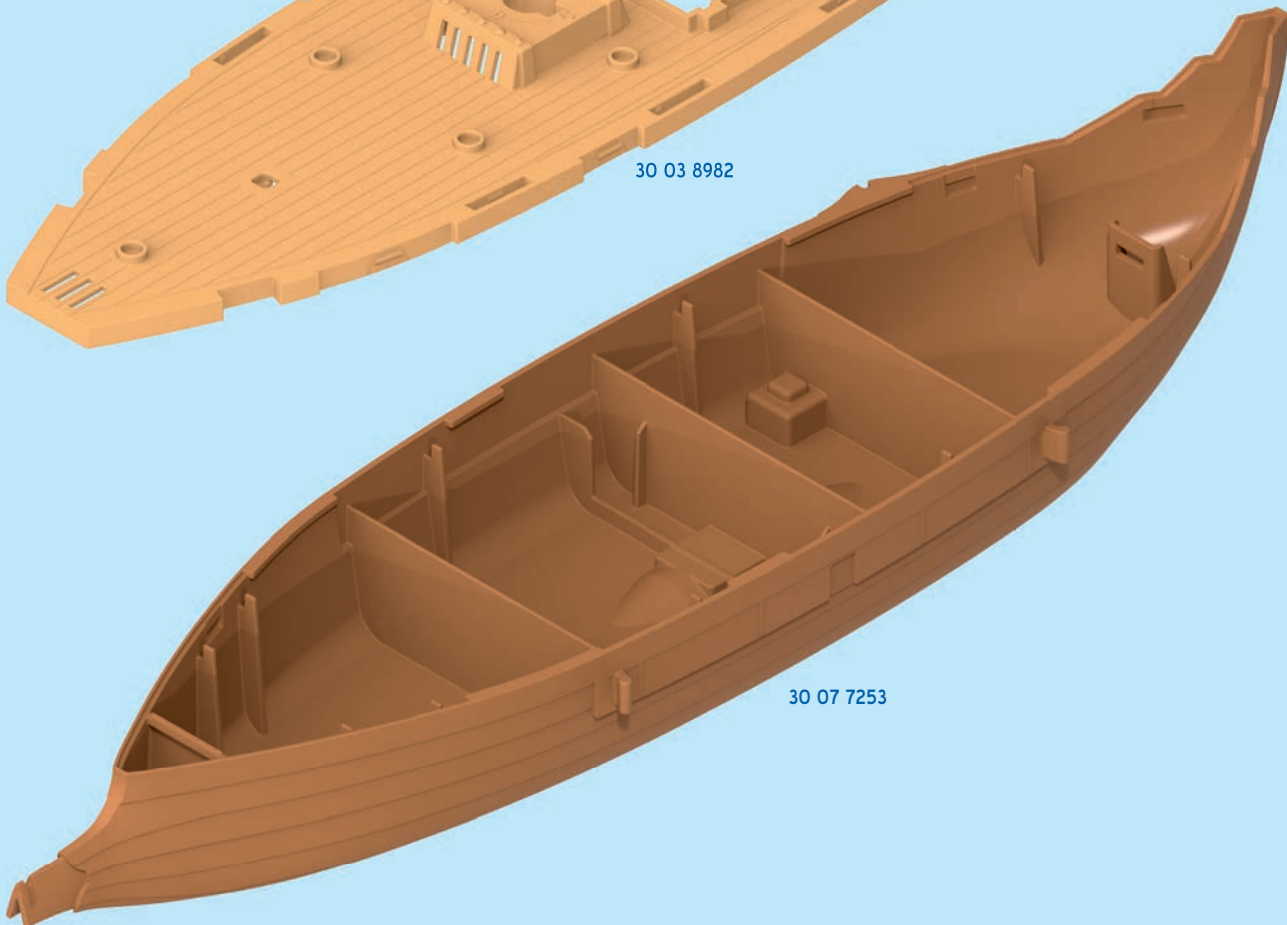
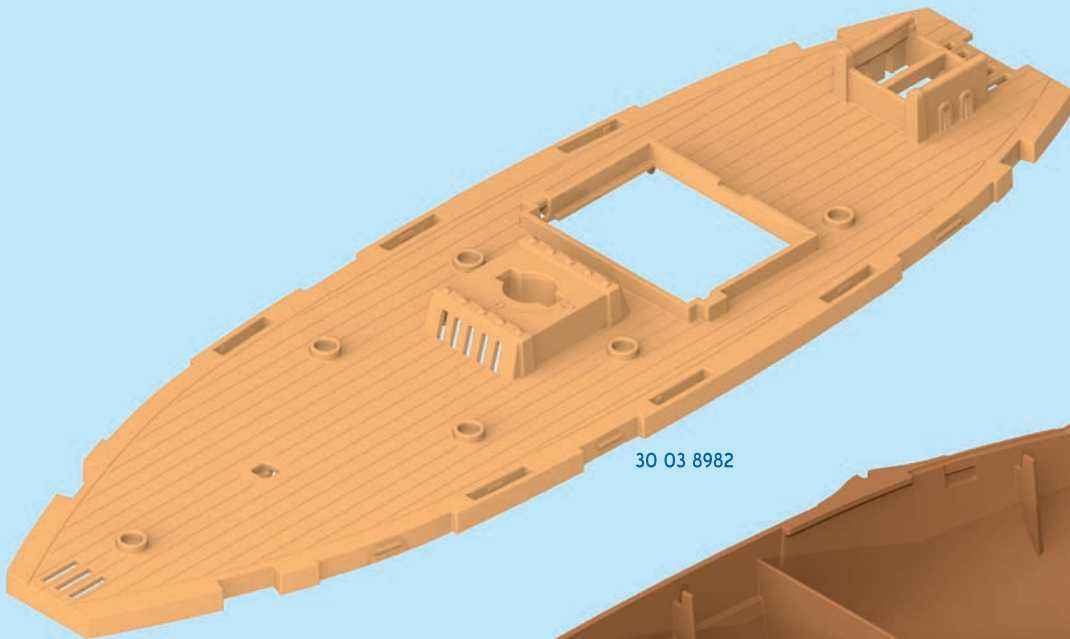
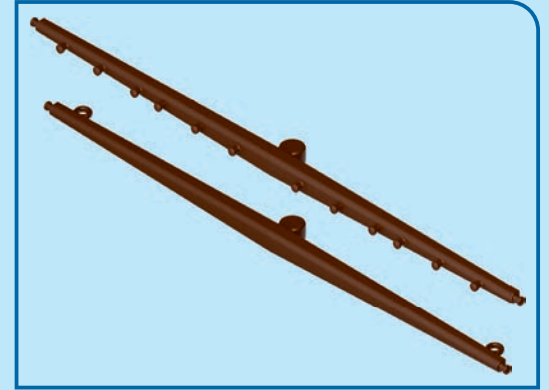
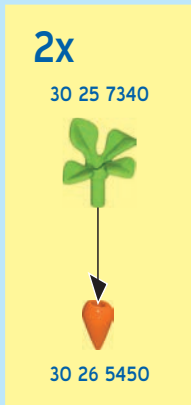
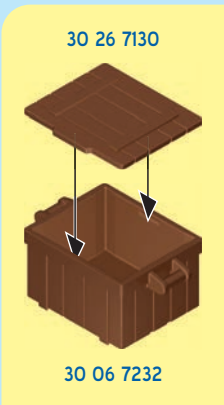

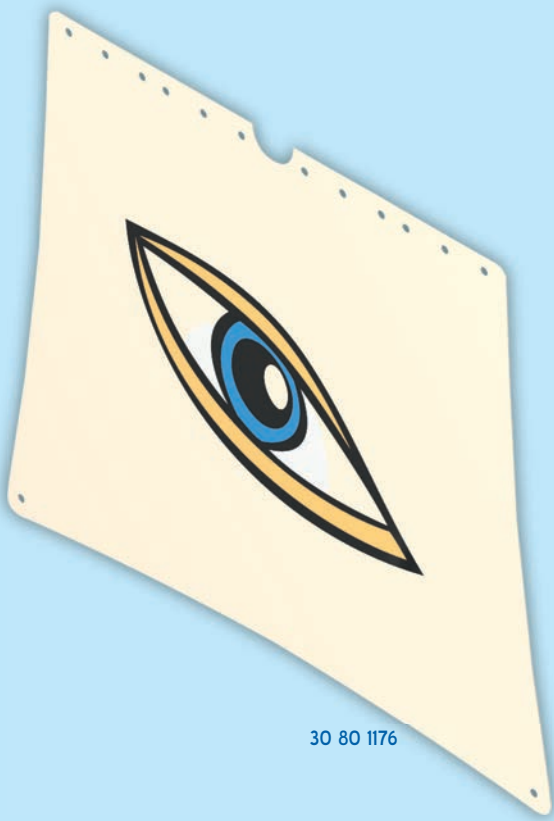

30 80 1176

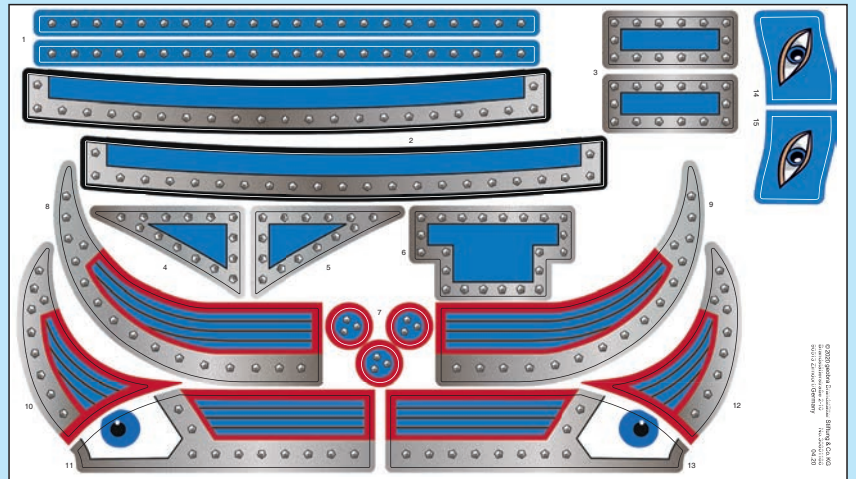

30 80 1186

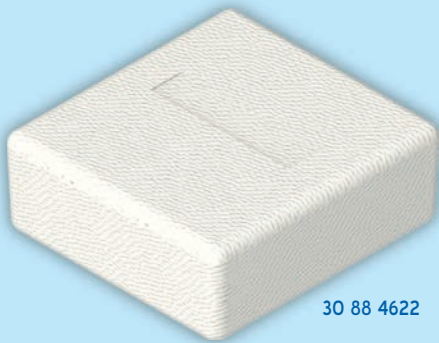

30 88 4622



30 46 7012

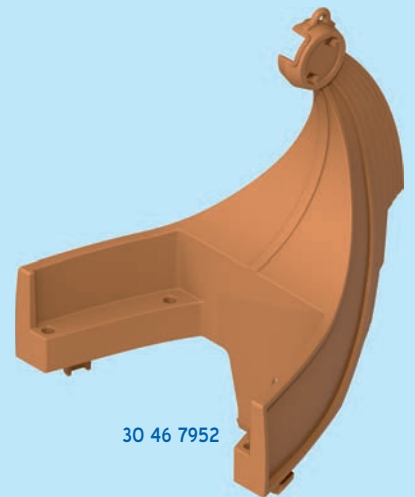

30 46 7952

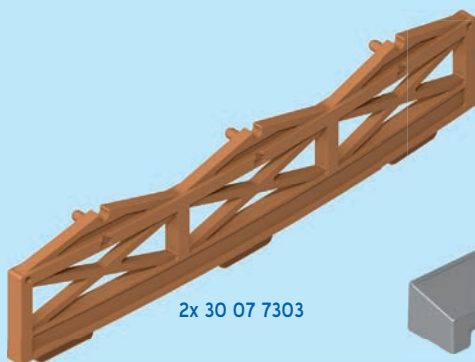

2x 30 07 7303

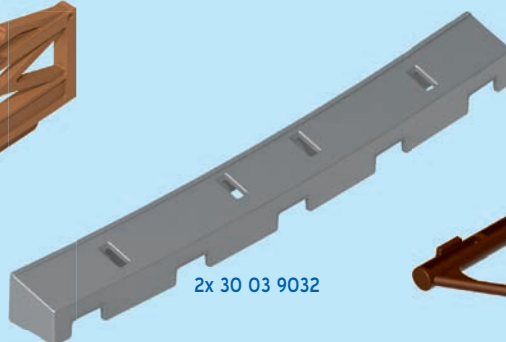

2x 30 03 9032



2x 30 07 7343



30 09 8580



30 22 8323



30 24 1782

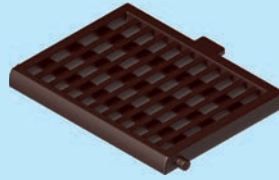

30 07 7283



30 03 9072

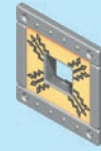

30 62 1405



30 24 2622



30 07 7273



30 21 7083



3x 30 03 9042



30 03 9062



30 07 7263



30 07 7323

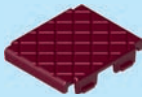

30 07 7293



30 07 7333



30 29 2500



30 29 2740

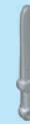

30 20 4560



30 25 6143

80 cm / (31.5 inch)



30 88 4632

57 cm / (22.4 inch)



30 88 4642



30 64 8686



30 07 7213



30 03 9052



2x 30 26 6990



4x 30 23 5040



2x 30 05 8550



2x 30 09 9300



30 06 3500



30 89 5422



30 09 6760



30 20 5050



30 25 0543



2x 30 63 3042



2x 30 26 6980



30 22 9962



2x 30 22 9830



30 22 8250

Serviceadressen finden Sie in allen PLAYMOBIL-Prospekten

Addresses of Customer Service Departments are shown in all PLAYMOBIL catalogues

L'adresse du service consommateurs est indiquée dans tous les catalogues PLAYMOBIL

Troverete gli indirizzi dei centri di assistenza in tutti i cataloghi PLAYMOBIL

In alle PLAYMOBIL catalogi vindt u het adres van onze klantendienst.

Las Direcciones de los Departamentos de Servicio al Consumidor se encuentran en todos los catálogos PLAYMOBIL

Η διεύθυνση του Γραφείου Εξυπηρέτησης Καταναλωτών PLAYMOBIL βρίσκεται σε όλους τους καταλόγους PLAYMOBIL.

pronounced: plāymō-bēēl

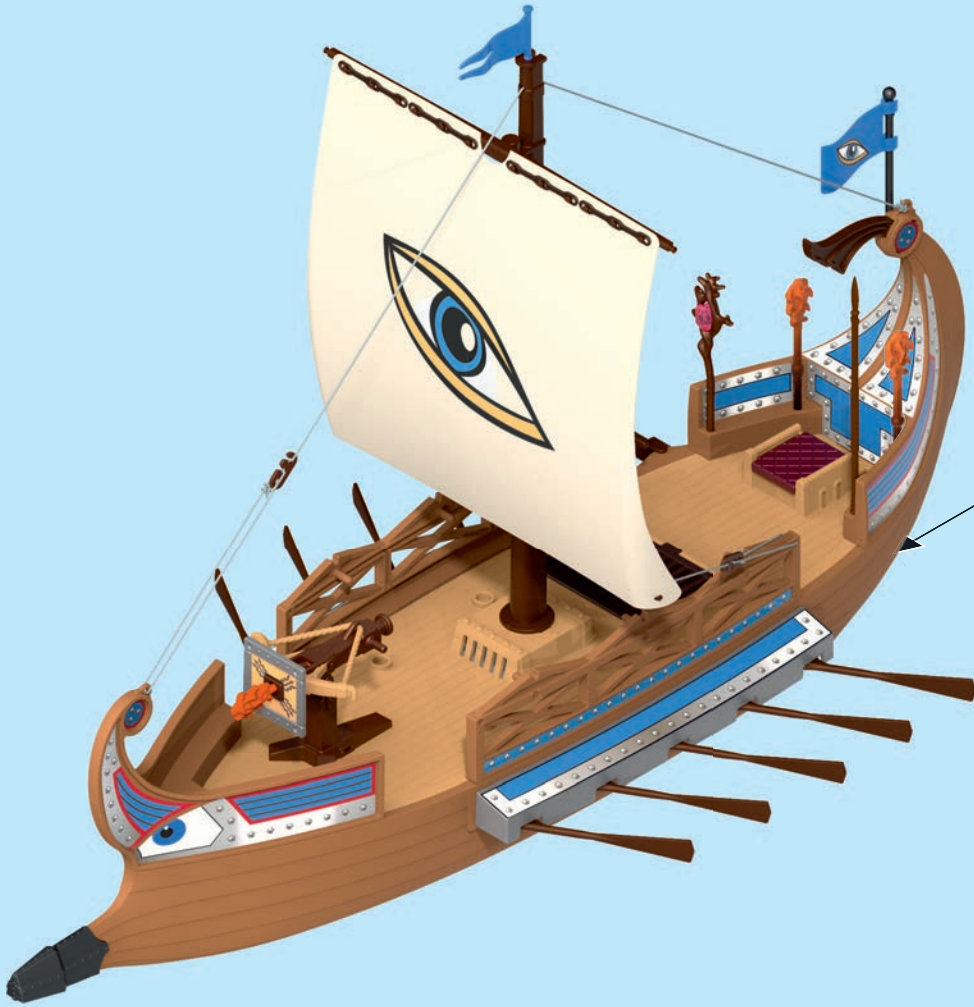

5159
7350

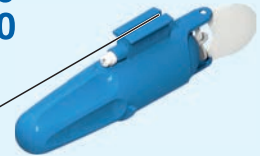

- Nachrüstbar mit Unterwassermotor
- Compatible with the underwater motor (sold separately)
- Monteur submersible, vendu séparément, s'adapte sur ce bateau

UK-Importer:
Playmobil UK Ltd.
 Regency House
 1 Miles Gray Road
 Basildon
 Essex
 SS14 3RW
 UK

**UK
CA**

(DE) (AT) (CH) (LU) (BE) Anbaumöglichkeiten des RC-UW-Motors finden Sie unter: RC-Motor.playmobil.com

(US) (GB) (CA) (MT) (IE) For RC UW motor attachment possibilities, visit: RC-Motor.playmobil.com

(FR) (CA) (BE) (LU) (CH) Vous trouverez des informations complémentaires sur le site Internet: RC-Motor.playmobil.com

(ES) (MX) Las posibilidades de montaje del motor submarino RC se pueden consultar en: RC-Motor.playmobil.com

(NL) (BE) Aanbouw mogelijkheden van de RC-Onderwatermotor vindt u op: RC-Motor.playmobil.com

(IT) (CH) Le possibilità di montaggio del motore RC-UW sono descritte al sito: RC-Motor.playmobil.com

(PT) As possibilidades de montagem do motor RC subaquático pode ser consultadas em: RC-Motor.playmobil.com

(DK) Montagemuligheder for RC-UW-motoren finder du på: RC-Motor.playmobil.com

(NO) Monteringsmuligheter for RC-UW-motoren finner du under: RC-Motor.playmobil.com

(SE) (FI) RC-undervattensmotorns monteringsmöjligheter hittar du på: RC-Motor.playmobil.com

(FI) Vedenalaisen RC-moottorin asennusmahdollisuuksia löytyy osoitteesta: RC-Motor.playmobil.com

(HU) Az RC-UW- Motor hozzáépítési lehetőségeiről az RC-Motor.playmobil.com alatt talál anyagot.

(CZ) Možnosti instalace lodního motoru s dálkovým ovládáním najdete na internetové adrese RC-Motor.playmobil.com

(EE) RC-UW-Motor'i paigaldusjuhised leiata aadressil: RC-Motor.playmobil.com

(LV) Informāciju par RC-UWV motora montāžas iespējām skati vietnē: RC-Motor.playmobil.com

(LT) RC UW variklio pritvirtinimo galimybes pateikiamos tokiame internetiniame puslapyje: RC-Motor.playmobil.com

(SI) Možni načini namestitve daljinsko krmiljenega (RC) podvodnega (UW) motorja so na voljo na naslovu: RC-Motor.playmobil.com

(SK) Možnosti inštalácie lodného motora s diaľkovým ovládaním nájdete na internetovej adrese RC-Motor.playmobil.com

(PL) Możliwości zastosowania podwodnego silnika RC znajdując się na stronie: RC-Motor.playmobil.com

(TR) (CY) Uzaktan kumandalı su altı motorunun montaj kılavuzu RC-Motor.playmobil.com sayfasında gösterilmiştir

(GR) (CY) Οδηγίες συναρμολόγησης του τηλεκατευθυνόμενου μοτέρ με υπέρυθρες ακτίνες θα βρείτε στην ηλεκτρονική διεύθυνση: RC-Motor.playmobil.com

(RO) Posibilități de montare a motorului submersibil cu telecomandă se găsește pe site-ul: RC-Motor.playmobil.com

(BG) Възможности за допълнително оборудване на RC-електромотора за под вода можете да намерите на адрес: RC-Motor.playmobil.com

(HR) Mogućnosti dogradnje RC-UW-Motora ćete pronaći pod: RC-Motor.playmobil.com

(CN) 了解红外线水下电机的安装方法请访问以下网站: RC-Motor.playmobil.com

HISTORY



70466



70465



70471



70470



70468



70469



70467

