

playmobil®



70364

SCOOPY-DOO!



A LEGO minifigure of Scooby-Doo and his owner, Shaggy, are shown in a spooky, dark forest at night. Scooby-Doo is a brown dog with black spots, wearing a blue collar and a yellow tag with the letters 'SD'. Shaggy is a young man with orange hair, wearing a green t-shirt and maroon pants. The background features a large, dark, multi-towered castle in the distance, bare trees, and flying bats under a blue, moonlit sky. The ground is covered in green moss.

SCOOBY-DOO

**NORVILLE
"SHAGGY"
ROGERS**

SCOOBY-DOO

Scooby-Doo ist eine sprechende, große Deutsche Dogge mit einem ebenso großen Appetit und Shaggys bester Freund. Er ist ein liebenswerter Angsthase, tut aber alles, um seine Freunde aus Gefahren zu befreien – besonders dann, wenn er mit einem Scooby-Snack motiviert wird. Auch wenn er in unheimlichen Momenten am liebsten Reißaus nehmen möchte, stellt er sich an der Seite seiner Freunde seinen Ängsten.

Scooby-Doo is Shaggy's best pal, a large Great Dane with a huge appetite. He's a lovable coward who won't face a ghost unless a Scooby Snack is involved. He is always the first to run if he hears a squeak, but his love for his friends often forces him to (reluctantly) confront his fears!

Scooby-Doo est le meilleur copain de Sammy, un grand Dogue allemand qui a un énorme appétit. C'est un trouillard adorable qui n'affrontera jamais un fantôme, à moins qu'une friandise Scooby soit de mise. C'est toujours le premier à s'enfuir lorsqu'il entend un grincement, mais son amour pour ses amis le force toujours (à contrecœur) à surmonter ses peurs !

Scooby-Doo es el mejor amigo de Shaggy, un enorme gran danés con un apetito insaciable. Es un cobarde adorable que no se enfrentará a un fantasma a menos que haya Scooby-galletas de por medio. Siempre es el primero en correr si se oye un chillido, ¡pero el amor por sus amigos a menudo le obliga (a regañadientes) a afrontar sus miedos!

NORVILLE "SHAGGY" ROGERS

Wie sein bester Freund Scooby-Doo ist auch Shaggy eher schreckhaft und mit einem unstillbaren Appetit gesegnet – die beiden verstehen sich also blind! Wenn er sich fürchtet, wird der eigentliche Drückeberger Shaggy zum wahren Athleten, der sogar Scooby-Doo beim Weglaufen überholen kann. Er ist ein unfreiwilliger Held, der sich beim Lösen rätselhafter Fälle stets bewährt und häufig sogar den Köder in Freds ausgetüftelten Fallen spielt.

Shaggy is often more interested in eating than solving mysteries. He and his best pal Scooby are both motivated by food and fear; they understand each other completely. Shaggy is a reluctant hero who proves useful in capturing villains, sometimes by acting as "live bait" for traps!

Le plus souvent, Sammy préfère manger que de résoudre des mystères. Son meilleur copain, Scooby, et lui sont tous les deux motivés par la nourriture et la peur: ils se comprennent très bien. Sammy est un héros malgré lui, qui s'avère utile pour capturer les méchants, parfois en jouant les "appâts vivants" des pièges!

Shaggy suele estar más interesado en comer que en resolver misterios. Él y su mejor amigo Scooby se mueven por la comida y el miedo, y se entienden a la perfección. Shaggy es un héroe a regañadientes que resulta ser muy útil para capturar villanos, ¡a veces actuando a modo de cebo en las trampas!

GHOST OF DAPPER JACK ROGERS

Der Ghost of Dapper Jack Rogers ist die Verkleidung von Kyle, einem Rancharbeiter auf der Crazy Q Farm. Zusammen mit seinem Kumpanen Rafe arbeitet Kyle daran, alle Grundstücke der Stadt aufzukaufen, um sie dann an einen Bauunternehmer für Ferienorte weiterzuverkaufen

The Ghost of Dapper Jack Rogers is the disguise of Kyle, a ranch hand at the Crazy Q Ranch, who was secretly working with his co-conspirator Rafe to buy all the land in town to sell to a resort developer.

Le fantôme de Dapper Jack Rogers est le costume de Kyle, un fermier au Crazy Q Ranch, qui travaillait secrètement avec son co-conspirateur Rafe pour acheter tous les terrains de la ville et les revendre à un promoteur.

El fantasma de Dapper Jack Rogers es el disfraz de Kyle, un rancharo de Crazy Q Ranch, que trabajaba en secreto con su conspirador Rafe para comprar toda la tierra de la ciudad para venderla a un complejo vacacional.





WARNING: CHOKING HAZARD

Small parts. Not for children under 3 years.

”Ne concerne que les USA“

Wichtige Unterlagen, bitte sorgfältig aufbewahren!
Important: Please keep these instructions for future reference!
Documents importants, à conserver soigneusement!
Los documentos importantes, por favor manténgalos en un lugar seguro!
Belangrijke documenten, bewaar deze zorgvuldig!

Abbildungen können vom Original abweichen.
Product may differ from image shown.
Les illustrations peuvent différer de l'original.
Las ilustraciones pueden diferir del original.
Afbeeldingen kunnen verschillen van het werkelijke artikel.

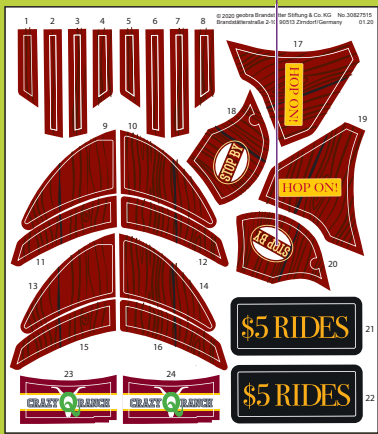
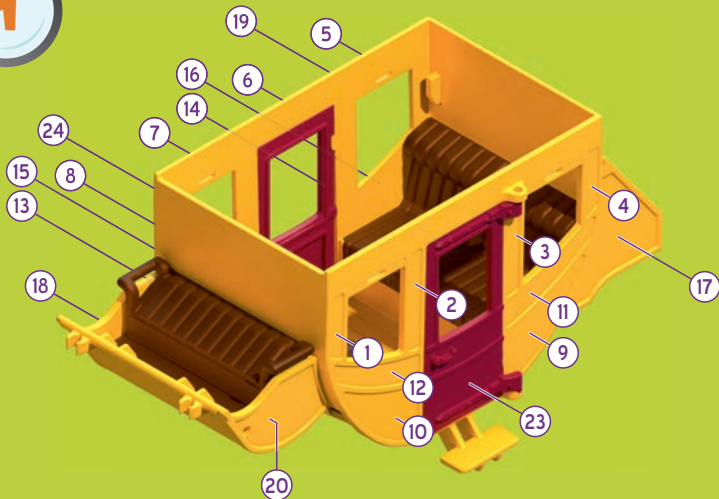

**ASSEMBLY
INSTRUCTION**

2

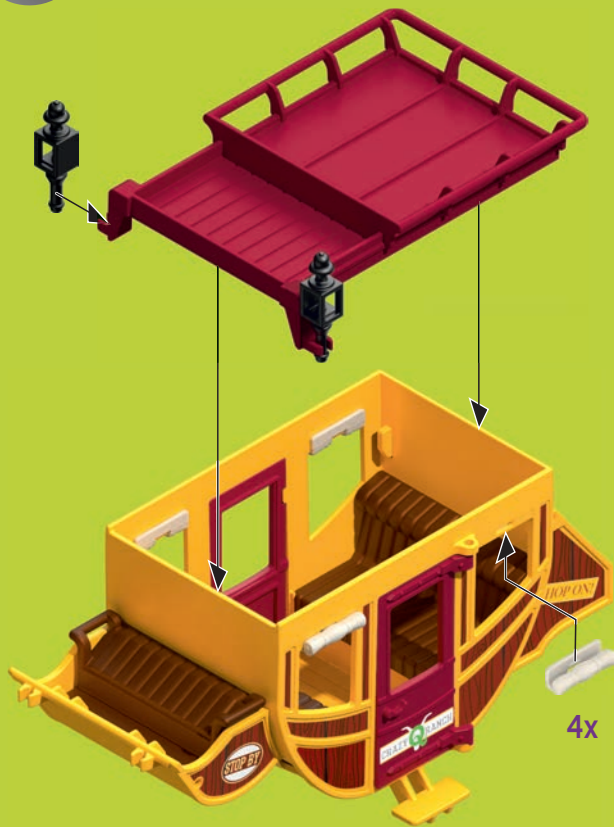

4x

3



4



**ASSEMBLY
INSTRUCTION**

5

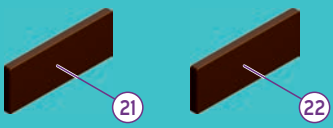
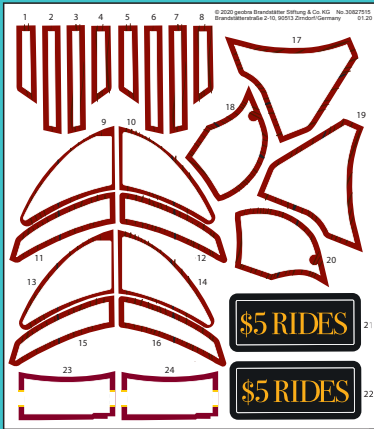

6

2x

1



2

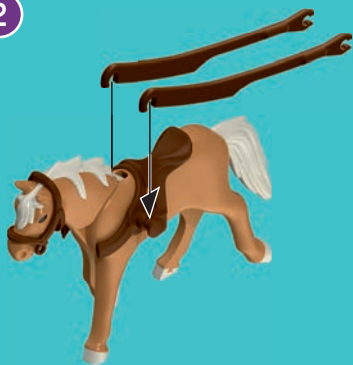

ASSEMBLY
INSTRUCTION

1

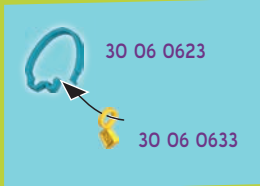

2

30 26 5330



oder
or
ou



1



2



30 06 7623



30 06 7633



30 61 1102

30 00 6974

oder
or
ou

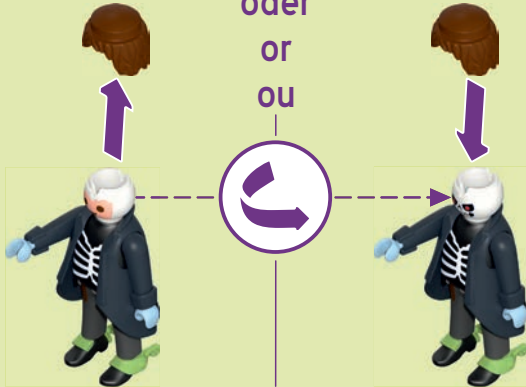

30 06 7553



30 00 6964



2x 30 66 2822

30 63 5283



30 06 7232



30 82 7525

30 03 0403

**ASSEMBLY
INSTRUCTION**



30 82 7515



30 06 7443



2x 30 06 7463



2x 30 06 7453



30 09 7372



30 60 8752

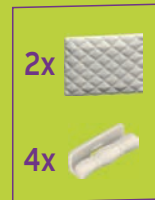

30 71 7184



30 73 3882



30 06 1050



2x 30 24 4772



2x 30 06 7543



4x 30 06 7433



2x 30 06 7423



2x 30 09 7392



2x 30 06 1080



30 21 0970



30 06 1060



2x 30 06 7613



2x 30 21 2512



30 89 5532

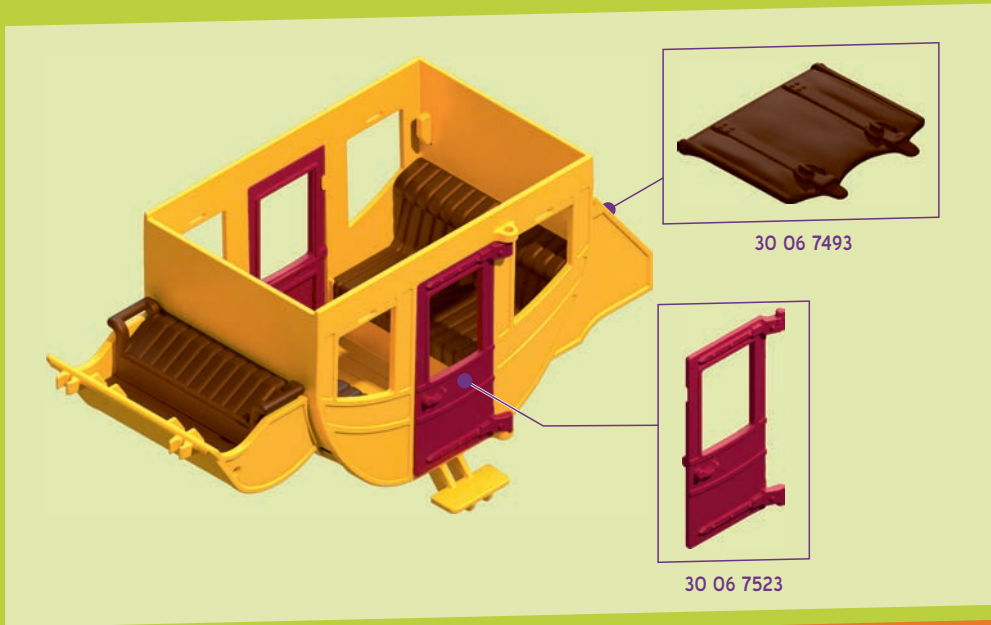

30 24 5440



30 06 7533

**ASSEMBLY
INSTRUCTION**

SCOOBY-DOO!

12 GEISTER ZUM SAMMELN

12 ghosts to collect • 12 fantômes à collectionner
12 fantasmas para coleccionar

SERIES
1



70288



70286



70287

Serviceadressen finden Sie in allen PLAYMOBIL-Prospekten
Addresses of Customer Service Departments are shown in all PLAYMOBIL catalogues

L'adresse du service consommateurs est indiquée dans tous les catalogues PLAYMOBIL

Troverete gli indirizzi dei centri di assistenza in tutti i cataloghi PLAYMOBIL

In alle PLAYMOBIL catalogi vindt u het adres van onze klantendienst.

Las Direcciones de los Departamentos de Servicio al Consumidor se encuentran en todos los catálogos PLAYMOBIL

Η διεύθυνση του Γραφείου Εξυπηρέτησης Καταναλωτών PLAYMOBIL βρίσκεται σε όλους τους καταλόγους PLAYMOBIL.

pronounced: plāy-mō-beē



● 70361



● 70363



● 70366



● 70364



● 70362



● 70365



70361



70362



70363



70364



70365



70366

ZUM SAMMELN!

Collect them all!
Collectionne les tous!
¡Para coleccionar!

GEISTER KARTEN



70286

GHOST CARDS CARTES FANTÔMES CARTA FANTASMA



70361

Gehe auf... Rends-toi sur...
Go to... Ve a...

scooby-doo.playmobil.com



SCOOBY-DOO and all related characters and elements © & ™
HANNA-BARBERA. WB SHIELD © & ™ WBEL. (s20)

© 2020 geobra Brandstätter Stiftung & Co. KG
Brandstätterstr. 2-10
90513 Zirndorf, Germany
No. 30 80 1336 08.20