

playmobil®

70306



WARNING:
CHOKING HAZARD

Small parts. Not for children under 3 years.

"Ne concerne que les USA"

Wichtige Unterlagen, bitte sorgfältig aufbewahren!
Important: Please keep these instructions for future reference!
Documents importants, à conserver soigneusement!
Belangrijke documenten, bewaar deze zorgvuldig!



Serviceadressen finden Sie in allen PLAYMOBIL-Prospekten

Addresses of Customer Service Departments are shown in all PLAYMOBIL catalogues

L'adresse du service consommateurs est indiquée dans tous les catalogues PLAYMOBIL

Troverete gli indirizzi dei centri di assistenza in tutti i cataloghi PLAYMOBIL

In alle PLAYMOBIL catalogi vindt u het adres van onze klantendienst.

Las Direcciones de los Departamentos de Servicio al Consumidor se encuentran en todos los catálogos PLAYMOBIL

Η διεύθυνση του Γραφείου Εξυπηρέτησης Καταναλωτών PLAYMOBIL βρίσκεται σε όλους τους καταλόγους PLAYMOBIL.

Trouverete gli indirizzi dei centri di assistenza in tutti i cataloghi PLAYMOBIL pronounced: plāy-mō-bēil

1

30 25 9032

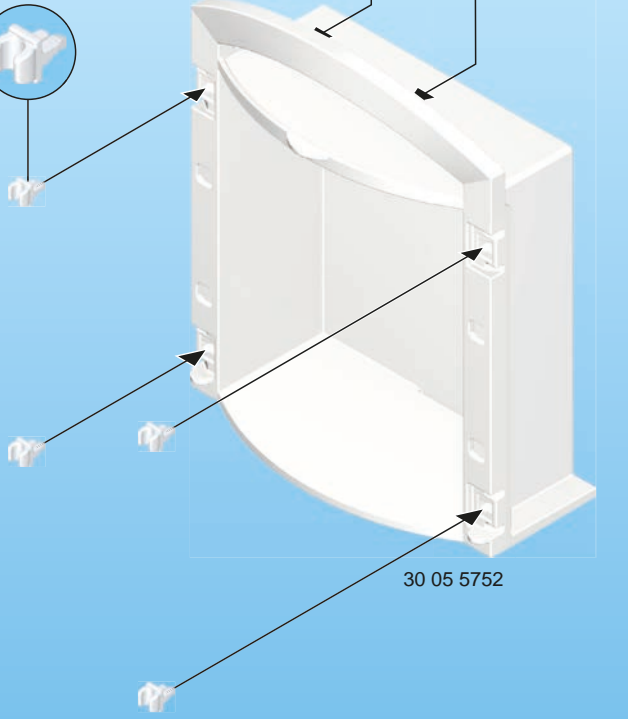

30 05 5752

2



30 80 4764

3

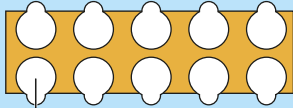

30 80 9313

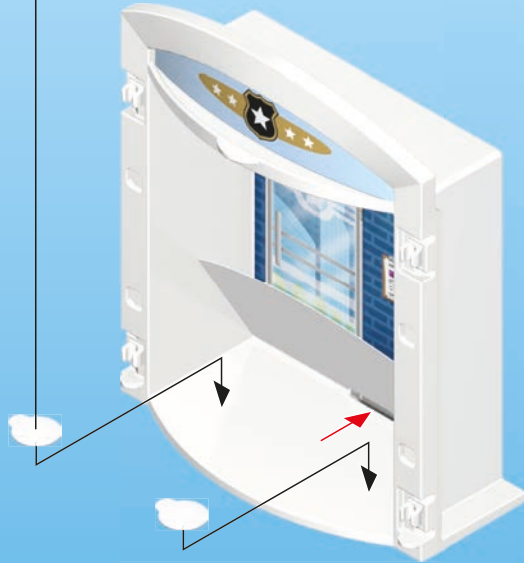

4

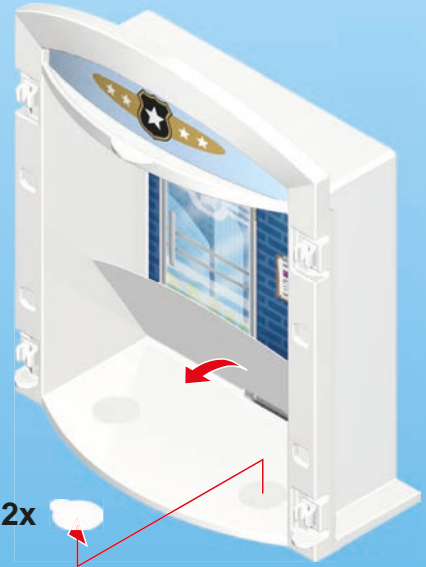

5

1

30 05 5762

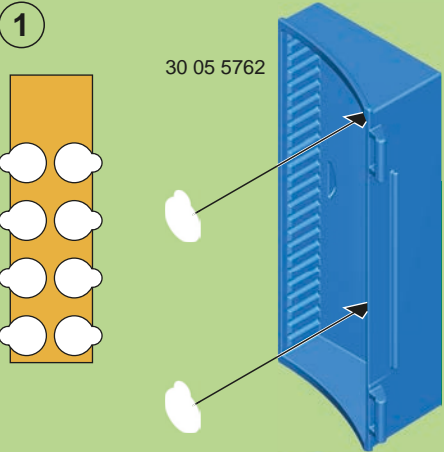

2

2x

30 80 4784

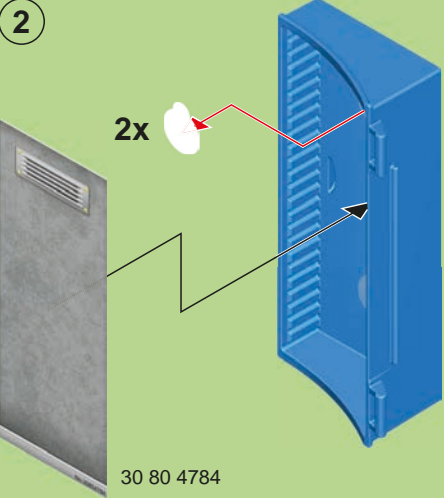
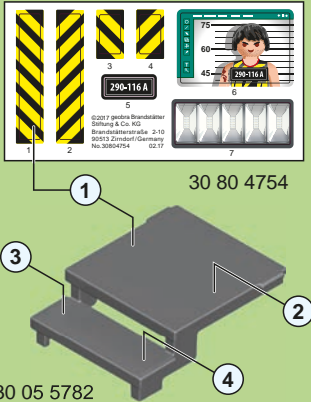

Diagram 1 shows a blue vertical panel with six white circular caps being attached to its top edge. Diagram 2 shows a grey door panel being attached to the blue frame using two white caps.



1

2

3

4

30 05 5782

30 80 4754

290-116 A

©2017 pediatric Brandstiftler
Stromer & Co. KG
Brandstiftlerstraße 2-10
10213 Dresden/Germany
No. 30804754 02.17

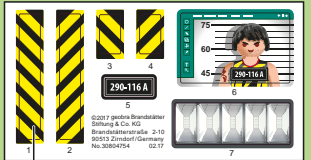

Diagram 3 shows a grey platform (30 05 5782) being assembled with a yellow and black striped safety mat (30 80 4754) and a grey base (30 05 5762). A reference image shows the mat being placed on a fire extinguisher cabinet.

30 22 6473

30 23 5933

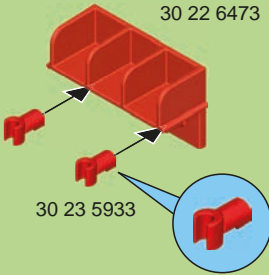

Diagram 4 shows a red shelf (30 22 6473) being attached to a red divider (30 23 5933) using a red pin.

30 24 4160

30 21 7660

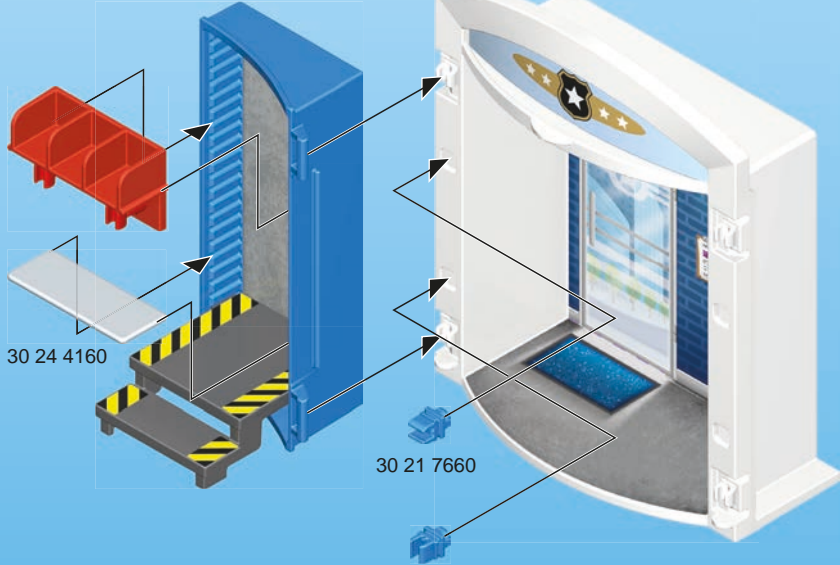
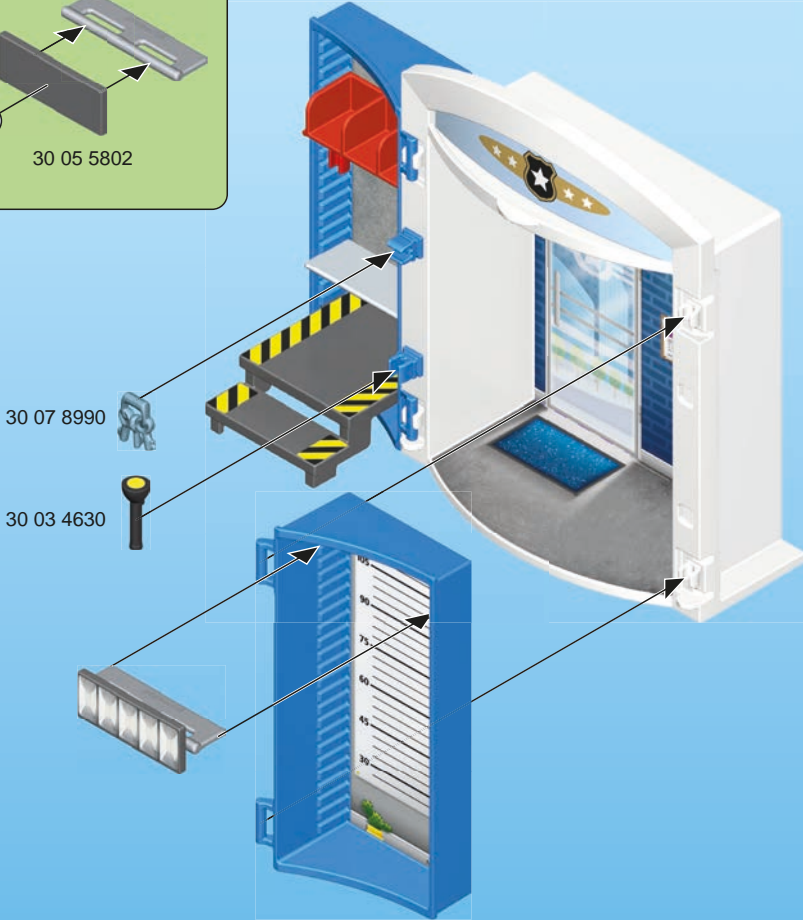
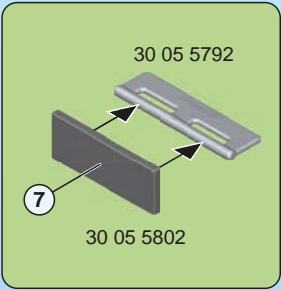
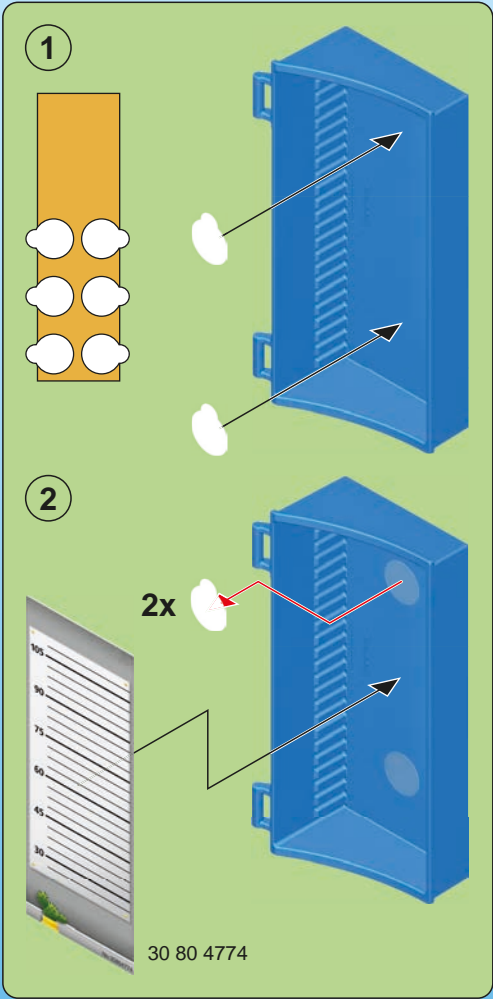
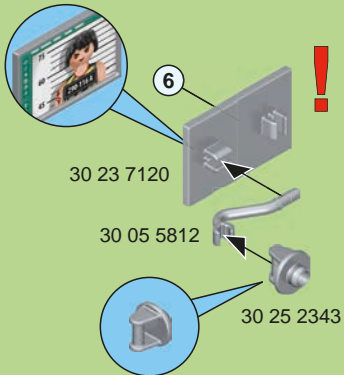
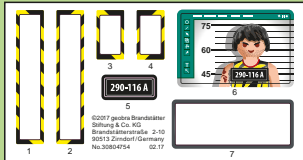

Diagram 5 shows the final assembly of the fire extinguisher cabinet. The red shelf (30 24 4160) and red divider (30 23 5933) are attached to the blue frame. The grey door panel (30 80 4784) is attached to the front. The final assembly is shown in a white cabinet with a blue mat (30 21 7660) and a blue pin (30 21 7660) attached to the bottom.

6



7



30 23 8052

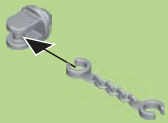

30 03 4940

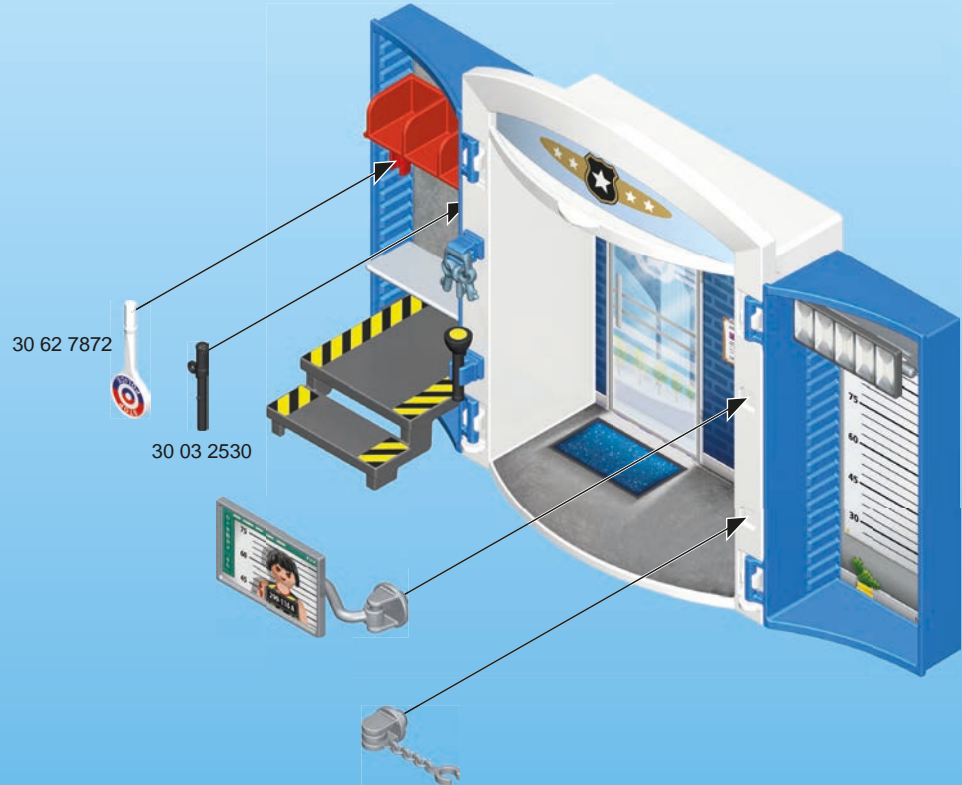

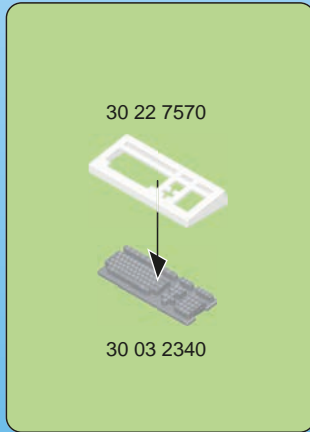
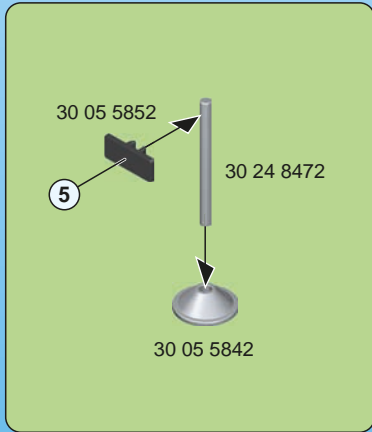
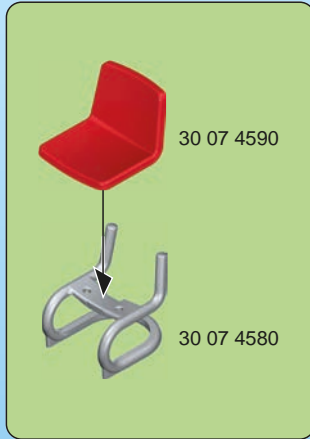
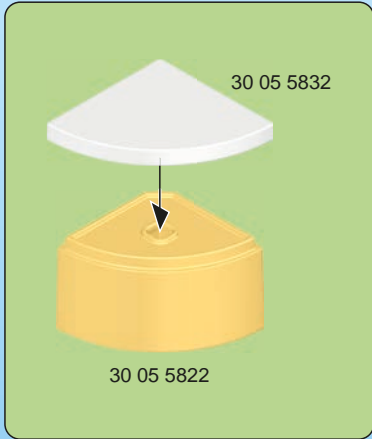

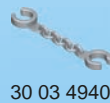

UK-Importer:
Playmobil UK Ltd.
Regency House
1 Miles Gray Road
Basildon
Essex
SS14 3RW
UK



© 2019 geobra Brandstätter Stiftung & Co.KG
Brandstätterstr. 2-10
90513 Zirndorf, Germany.
No. 30 82 6735 01.21



www.playmobil.com