

playmobil®

# SPORTS & ACTION



- SPIELANLEITUNG
- GAME INSTRUCTIONS
- RÈGLES DU JEU
- SPELREGELS
- INSTRUKCJA GRY
- SPELREGLER
- REGLAS DE JUEGO
- REGRAS DO JOGO
- Οδηγίες παιχνιδιού
- ISTRUZIONI DI GIOCO
- SPILLEREGLER



[playmobil.pm/instructions](http://playmobil.pm/instructions)



70244







# WARNING: CHOKING HAZARD

Contains a small ball and small parts.  
Not for children under 3 years.

"Ne concerne que les USA"

Wichtige Unterlagen, bitte sorgfältig aufbewahren!  
Important: Please keep these instructions for future reference!  
Documents importants, à conserver soigneusement!  
¡Por favor, guarde estas instrucciones para el futuro!  
Belangrijke documenten, bewaar deze zorgvuldig!

Abbildungen können vom Original abweichen.  
Product may differ from image shown.  
Les illustrations peuvent différer de l'original.  
Las ilustraciones pueden diferir del original.  
Afbeeldingen kunnen verschillen van het werkelijke artikel.

1



30 82 5145

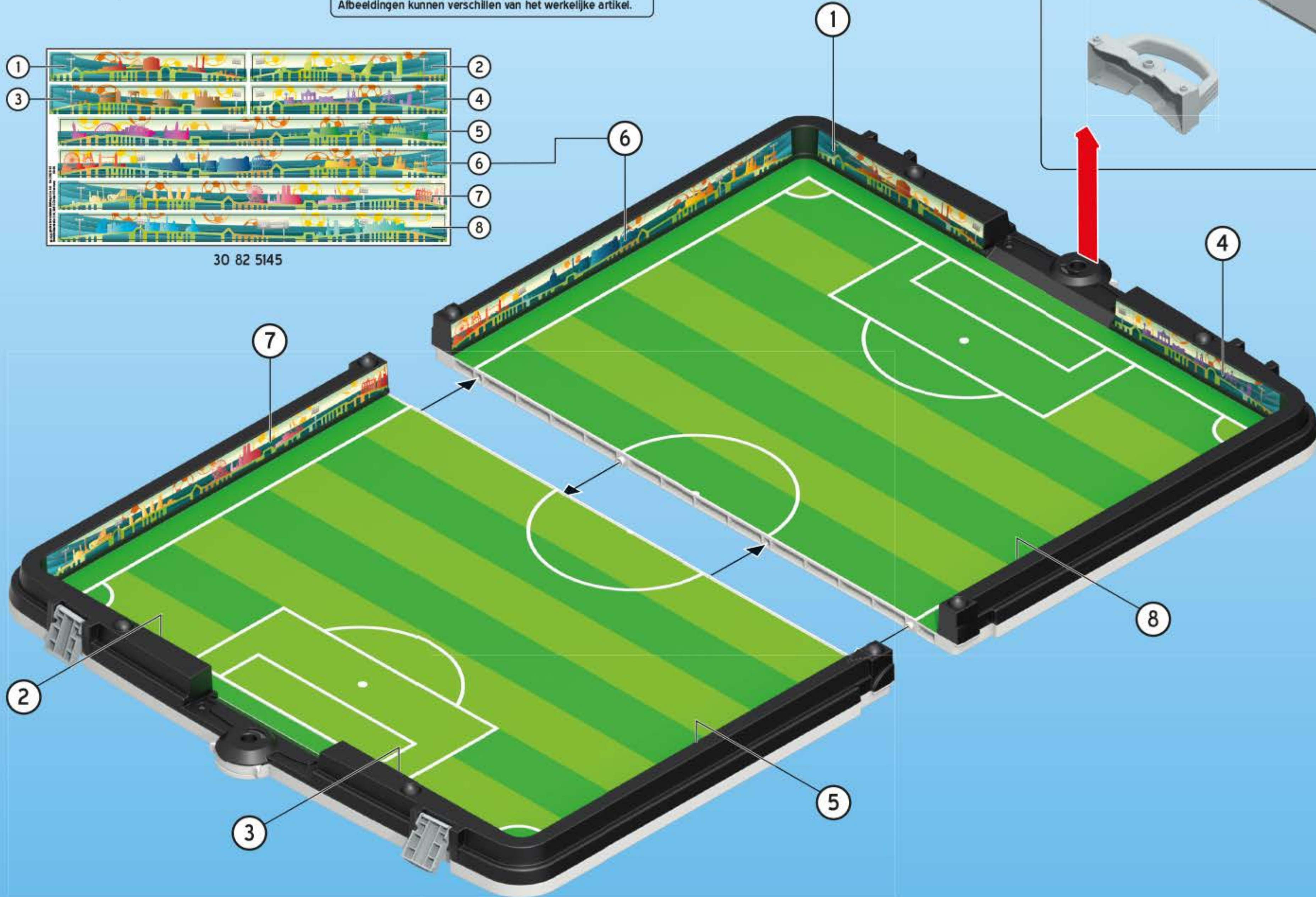



1

30 82 5155



2



1

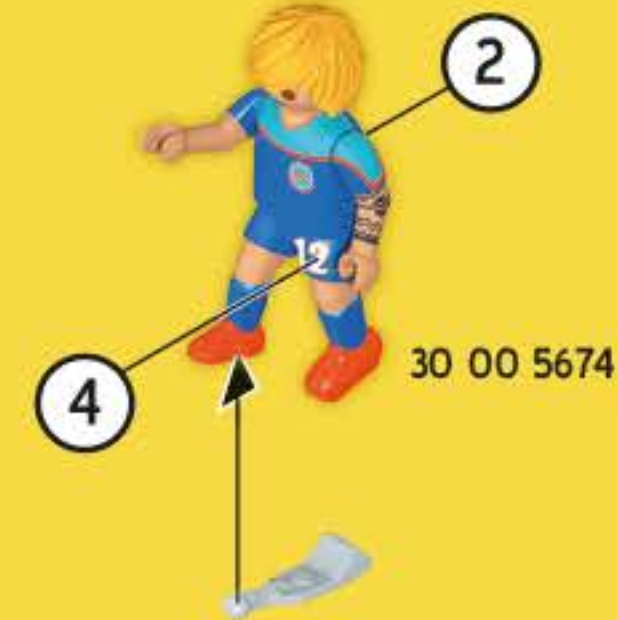

2



1

2x

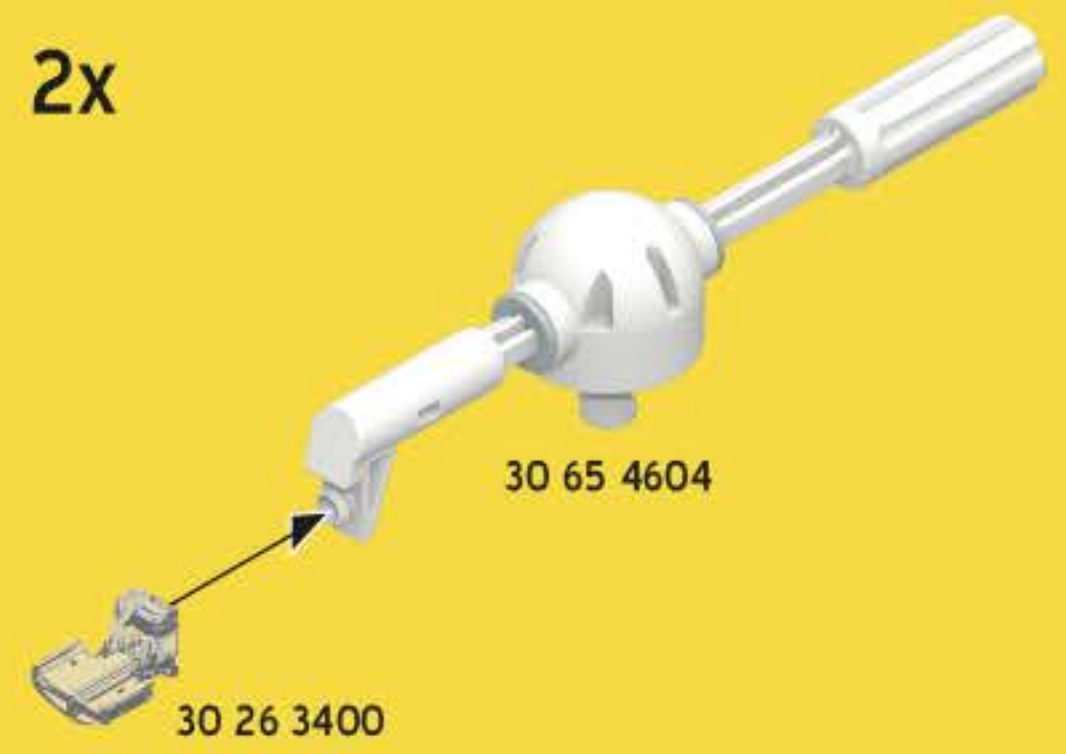

2

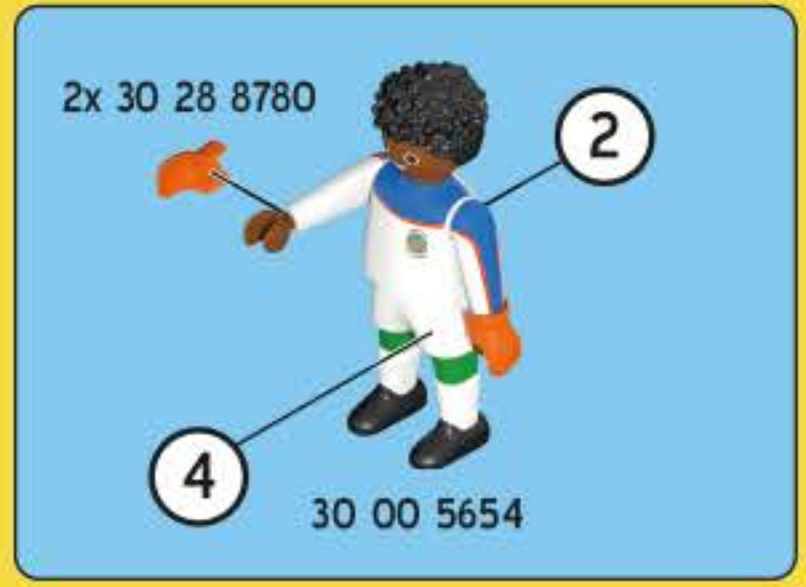
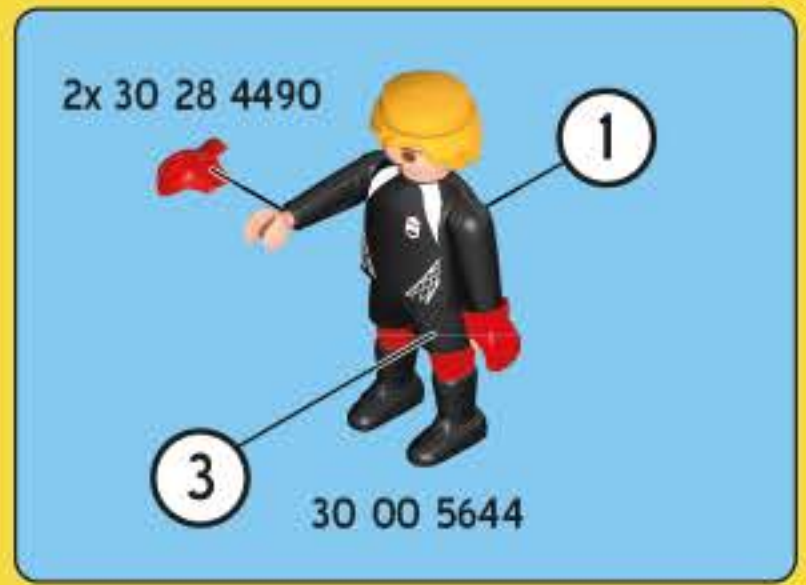



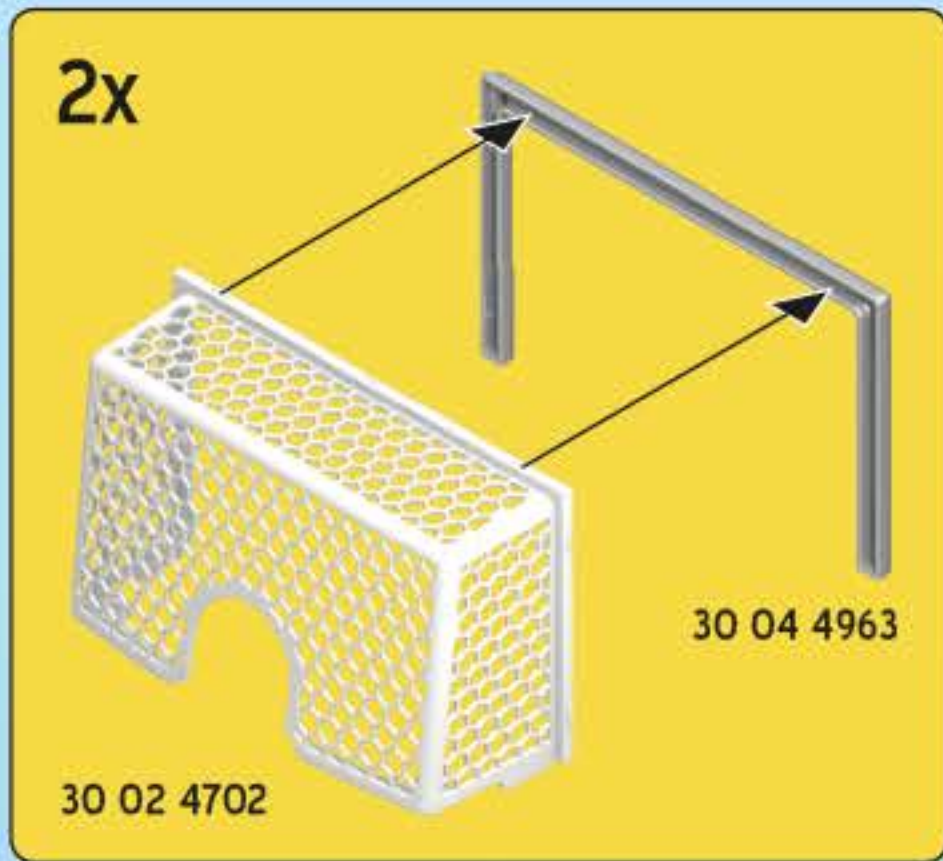

2

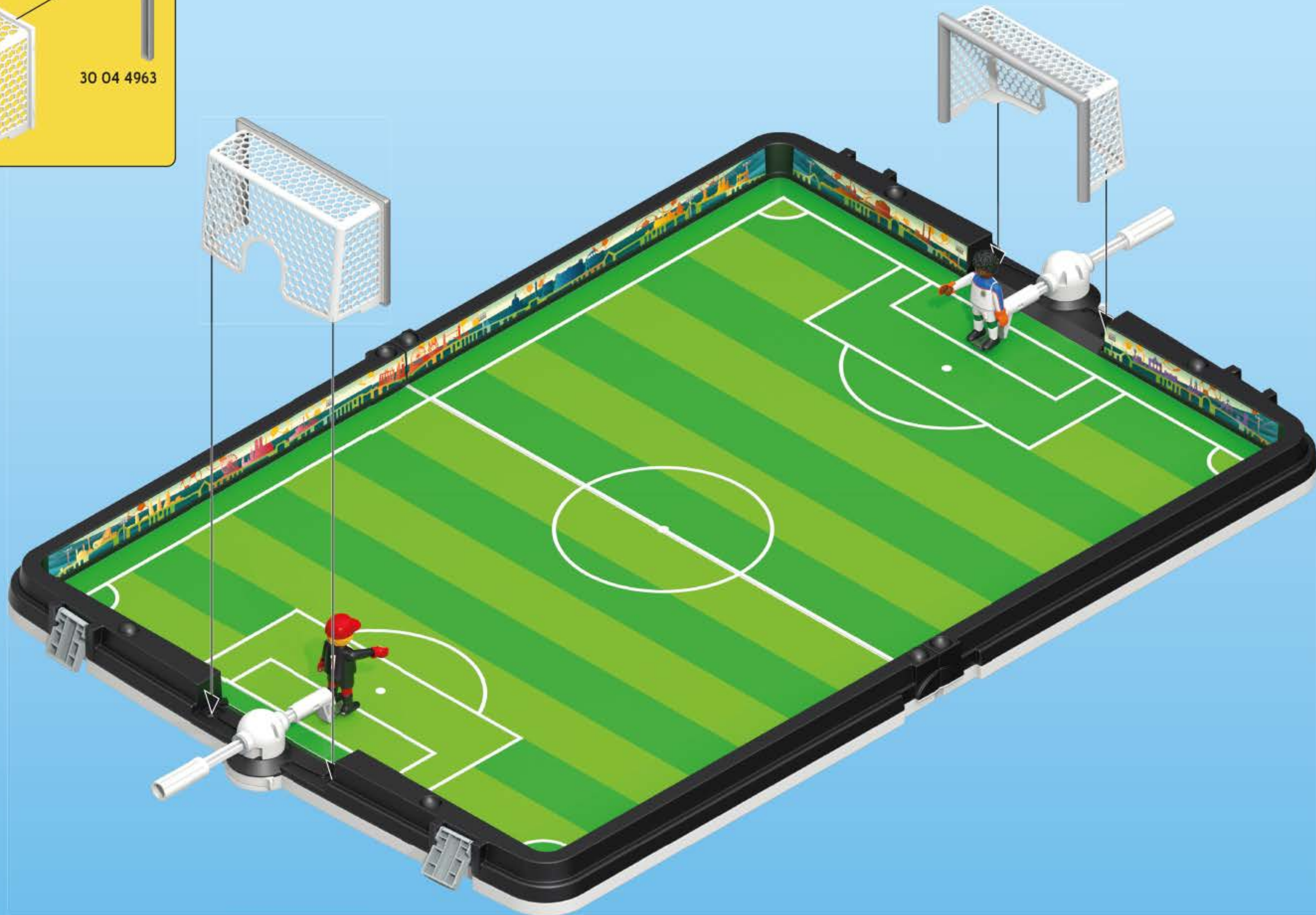



**4x**  
30 63 0656

30 63 0656

**3**



**DE AT CH LU BE ACHTUNG!**  
Nicht auf Augen oder Gesicht zielen.

**US GB CA MT IE WARNING!**  
Do not aim at eyes or face.

**FR CA BE LU CH ATTENTION!**  
Ne pas viser les yeux ou le visage

**ES MX ¡ADVERTENCIA!**  
No apuntar a los ojos ni a la cara.

**NL BE WAARSCHUWING!**  
Niet op ogen of gezicht richten.

**IT CH AVVERTENZA!**  
Non mirare agli occhi o al viso.

**PT ATENÇÃO!**  
Não apontar para os olhos ou face.

**DK ADVARSEL!**  
Sigt ikke mod øjne eller ansigt.

**NO ADVARSEL!**  
Sikt ikke på ansikt eller øyne.

**SE FI VARNING!**  
Sikta inte mot ögon eller ansikte.

**FI VAROITUS!**  
Ei saa kohdistaa suoraan silmiin tai kasvoihin.

**HU FIGYELMEZTETÉS.**  
Tilos szemre vagy arca célozni.

**CZ UPOZORNĚNÍ!**  
Nemířte na oči nebo na obličej!

**EE HOIATUS!**  
Ära sihi silmadesse ega näkku.

**LV BRĪDINĀJUMS!**  
Nevērst pret acīm vai seju.

**LT ĮSPĖJIMAS!**  
Netaikyti į akis arba veidą.

**SI OPOZORILO!**  
Ne merite v oči ali obraz.

**SK UPOZORNENIE!**  
Nemierť do očí alebo do tváre.

**PL OSTRZEŻENIE!**  
Nie celować w oczy i twarz.

**TR CY DİKKAT!**  
Göze veya yüze doğru tutmayınız.

**GR CY Προειδοποίηση!**  
Μη μην γίνεται στόχευση στα μάτια ή στο πρόσωπο.

**RO AVERTISMENT!**  
Nu se țintește în ochi sau în față.

**BG Внимание!**  
Не насочвайте към очите и лицето.

**HR UPOZORENJE!**  
Ne ciljati u oči ili lice.

**CN 警告! 请勿瞄准眼睛或脸。**



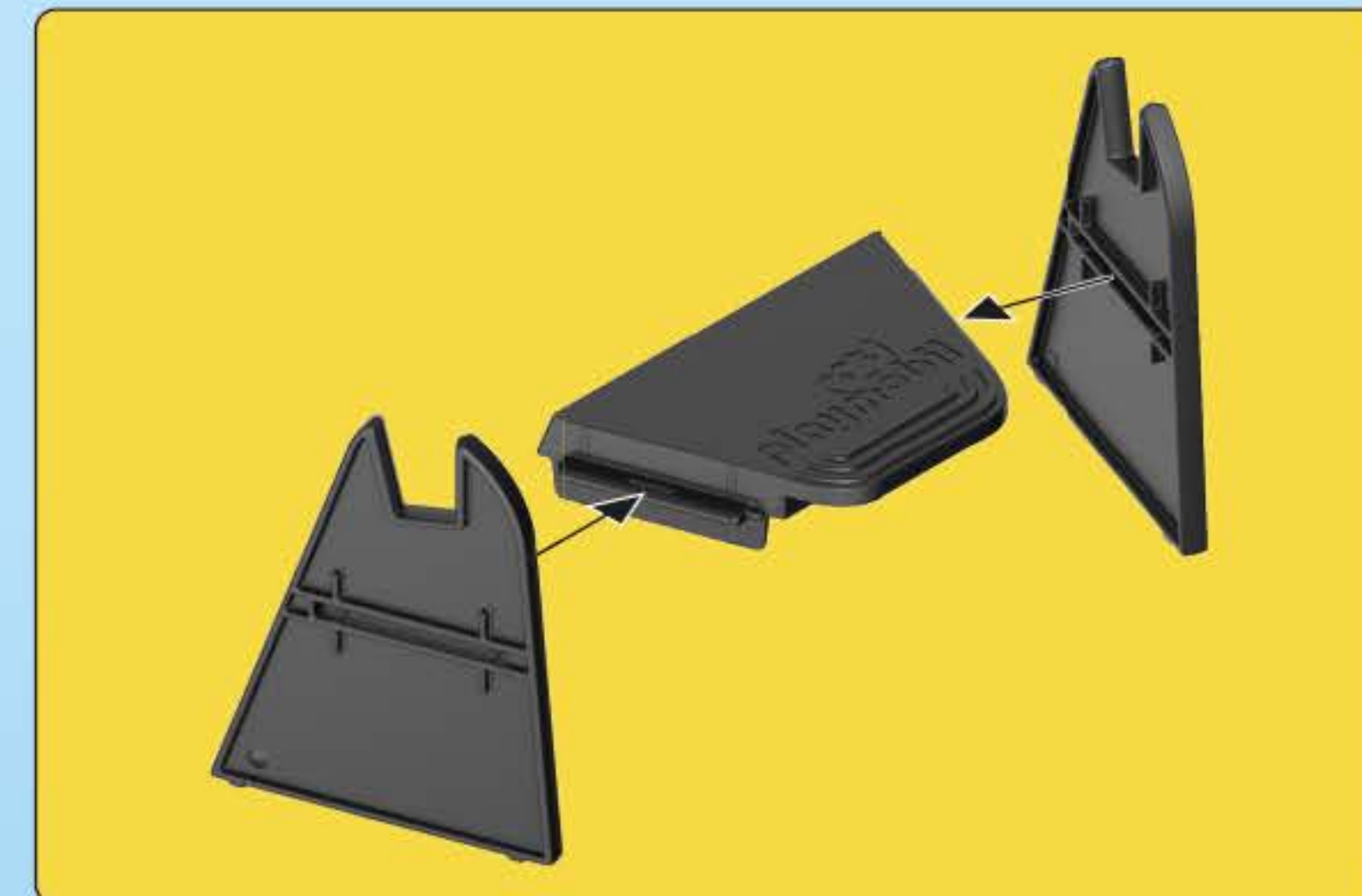

30 51 9522

stadion.playmobil.com



**iOS system requirements:**

- Supports iOS 10.3 or later
- iPhone 5s and up
- iPod Touch 6 and up

**Android system requirements:**

- Supports Android version 5.0 or later

**DE AT CH LU BE ACHTUNG!**  
Bitte deine Eltern um Hilfe beim Herunterladen der App.  
Benutzung der App nur unter Aufsicht von Erwachsenen empfohlen.

**US GB CA MT IE WARNING!**  
Please ask your parents to help you download the app.  
We recommend that the app is only used under the supervision of adults.

**FR CA BE LU CH ATTENTION!**  
Demande à tes parents de t'aider à télécharger cette app.  
Nous recommandons d'utiliser cette app seulement sous la surveillance d'un adulte.

**ES MX ¡ADVERTENCIA!**  
Pide a tus padres que te ayuden a descargar la app.  
Se recomienda usar la app sólo bajo supervisión de un adulto.

**NL BE WAARSCHUWING!**  
Vraag om hulp aan je ouders om de App te downloaden.  
Wij raden aan de App alleen onder toezicht van volwassenen te gebruiken.

**IT CH AVVERTENZA!**  
Chiedi ai tuoi genitori di aiutarti a scaricare la App.  
L'impiego della App è raccomandato solo sotto la supervisione di un adulto.

**PT ATENÇÃO!**  
Pede aos teus pais que te ajudem a carregar a App.  
Recomenda-se a utilização da App somente sob vigilância de adultos.

**DK ADVARSEL!**  
Bed dine forældre om hjælp, når du skal hente appen.  
Det anbefales kun at anvende appen, når en voksen fører opsyn.

**NO ADVARSEL!**  
Be foreldrene dine om hjelp til å laste ned appen.  
Vi anbefaler kun bruk under tilsyn av en voksen.

**SE FI VARNING!**  
Be dina föräldrar om hjälp med att ladda ner appen.  
Vi rekommenderar att denna app endast används under uppsikt av en vuxen person.

**FI VAROITUS!**  
Pyydä vanhempiasi auttamaan sovelluksen lataamisessa.  
Suosittelemme sovelluksen käyttöä ainoastaan aikuisten valvonnassa.

**HU FIGYELMEZTETÉS!**  
Az alkalmazás letöltéséhez kérj segítséget a szüleidtől.  
Az alkalmazás használatát csak szülői felügyelet mellett javasolt.

**CZ UPOZORNĚNÍ!**  
Popros své rodiče o pomoc se stažením aplikace.  
Doporučuje se používat aplikaci jen pod dohledem dospělých.

**EE HOIATUS!**  
Palu oma vanemaid, et nad aitaksid sul rakenduse alla laadida.  
Rakendust on soovitatav kasutada ainult täiskasvanu järelevalve all.

**LV BRĪDINĀJUMS!**  
Lietotnes lejupielādei palūdz vecāku palīdzību.  
Lietotnes izmantošana ieteicama vienīgi vecāku uzraudzībā.

**LT ĮSPĖJIMAS!**  
Paprasyk savo tėvėlių, kad jie padėtų nusikrauti programėlę.  
Naudotis programėle rekomenduojama prižiūrint suaugusiesiems.

**SI OPOZORILO!**  
Prosi starše, da ti pomagajo prenesti program s spleta.  
Priporočamo, da se program uporablja le pod nadzorom odraslih.

**SK UPOZORNENIE!**  
Popros svojich rodičov o pomoc so stiahnutím aplikácie.  
Odporúča sa používať aplikáciu len pod dohľadom dospelých.

**PL OSTRZEŻENIE!**  
Poprosz rodziców o pomoc w zainstalowaniu aplikacji z Internetu.  
Zaleca się, aby dziecko korzystało z aplikacji pod nadzorem osoby dorosłej.

**TR CY DİKKAT!**  
App'i indirirken annenden babandan yardım iste.  
App'in yalnızca yetişkinlerin gözetimi altında kullanılması önerilir.

**GR CY Προειδοποίηση!**  
Ζήτησε βοήθεια από τους γονείς σου για να κατεβάσεις την εφαρμογή.  
Συνιστάται η χρήση της εφαρμογής κάτω από την επίβλεψη ενήλικα.

**RO AVERTISMENT!**  
Roagă-i pe părinți să te ajute la descărcarea aplicației.  
Se recomandă folosirea aplicației doar sub supravegherea unui adult.

**BG Внимание!**  
Помоли родителите си да ти помогнат да свалиш приложението (app).  
Препоръчително е приложението да се използва само под надзора на възрастен.

**HR UPOZORENJE!**  
Zamoli svoje roditelje za pomoć oko skidanja aplikacije.  
Korištenje aplikacije preporuča se samo pod nadzorom odraslih.

**CN 警告!**  
在下载App时请你的父母帮助你。  
建议只有在有成人监督下才使用本App。



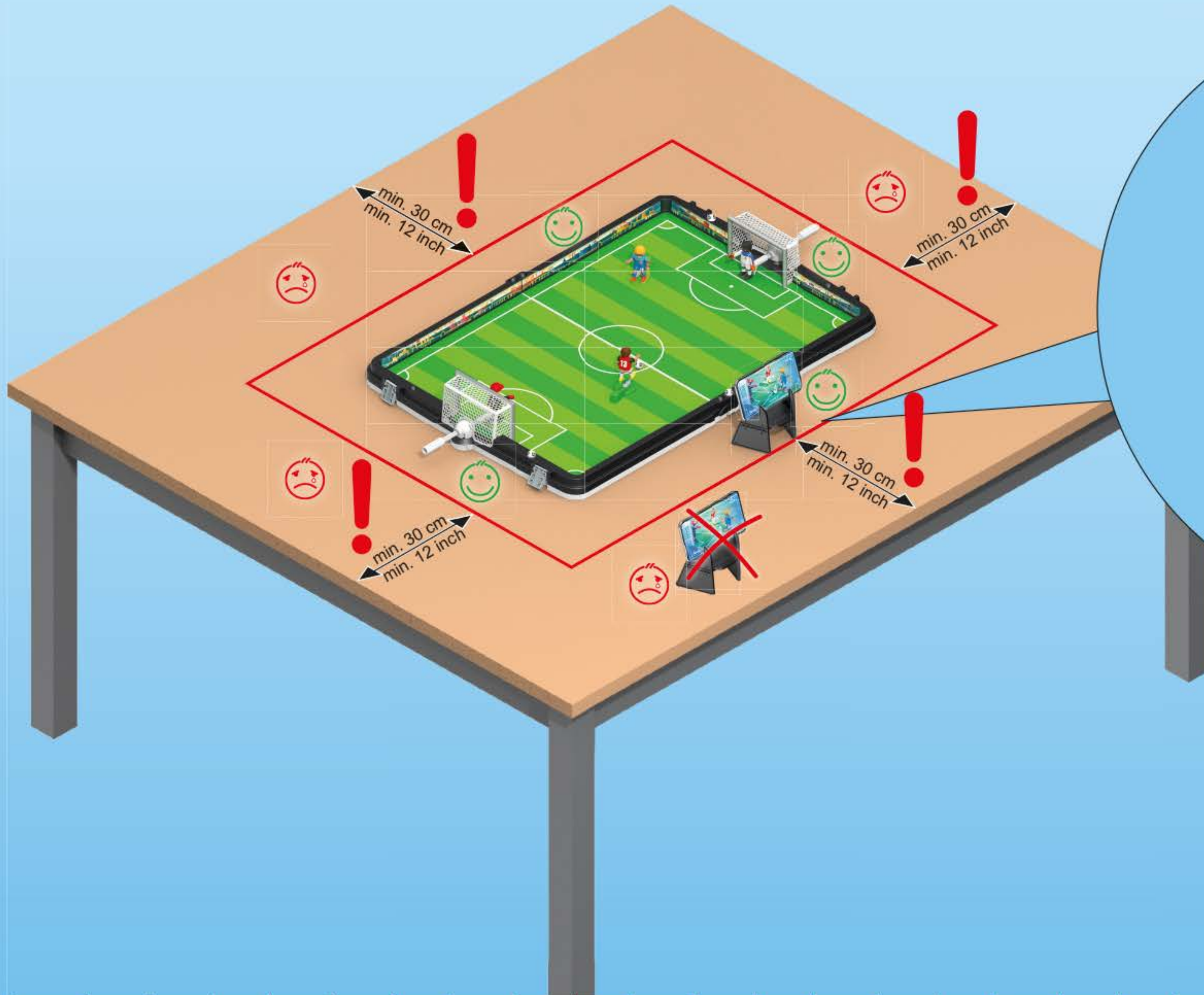





1

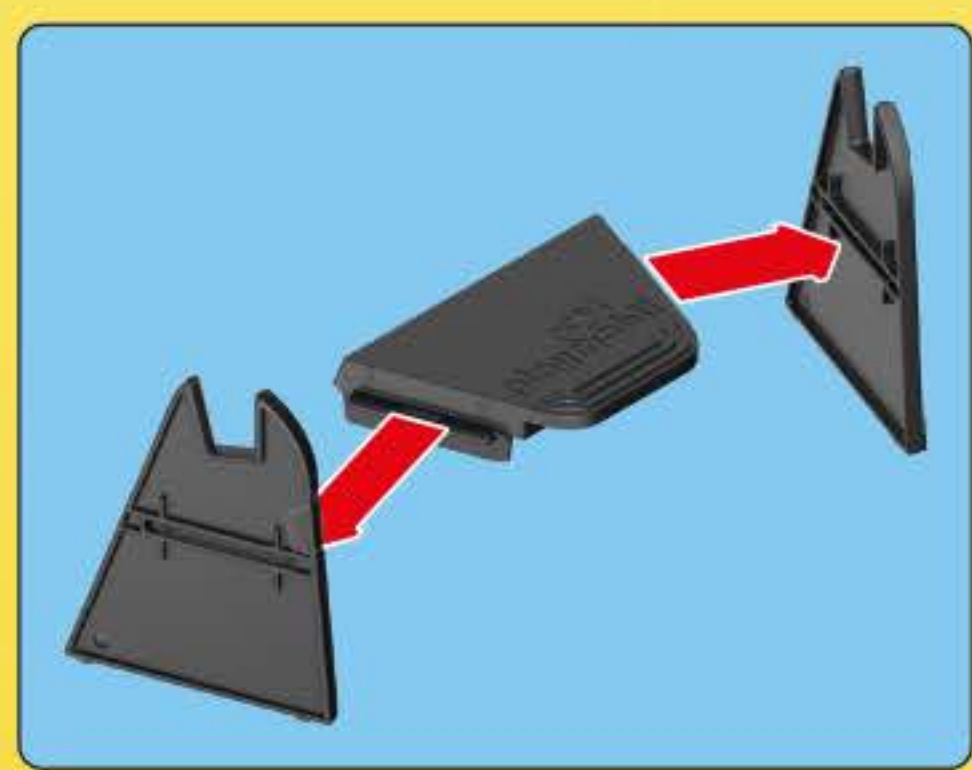



2

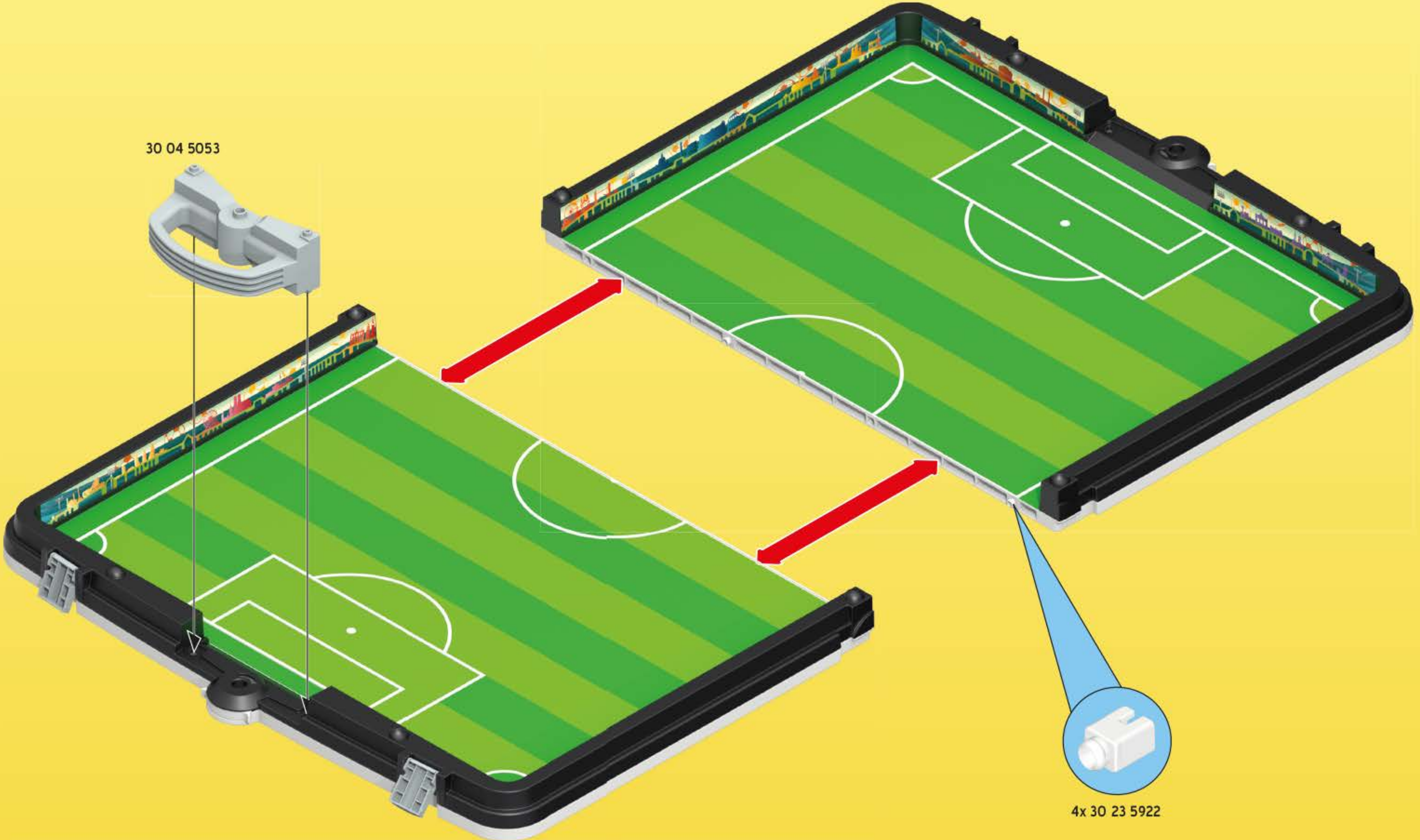



3





4



Serviceadressen finden Sie in allen PLAYMOBIL-Prospekten	In alle PLAYMOBIL catalogi vindt u het adres van onze klantendienst.
Addresses of Customer Service Departments are shown in all PLAYMOBIL catalogues	Las Direcciones de los Departamentos de Servicio al Consumidor se encuentran en todos los catálogos PLAYMOBIL.
L'adresse du service consommateurs est indiquée dans tous les catalogues PLAYMOBIL.	Η διεύθυνση του Γραφείου Εξυπηρέτησης Καταναλωτών PLAYMOBIL βρίσκεται σε όλους τους καταλόγους PLAYMOBIL.
Troverete gli indirizzi dei centri di assistenza in tutti i cataloghi PLAYMOBIL.	pronounced: plāy-mō-bēēl





○ 70479



⊗ 70244



○ 70245



○ 70246



○ 70480



○ 70481



○ 70482



○ 70483



○ 70484



○ 70485



○ 70486



○ 70487