

playmobil®

# NOVELMORE

70220



# NOVELMORE

In der Stadt Novelmore entwickeln der geniale Erfinder Dario Da Vanci und seine Freunde eine neue Idee nach der anderen. Beflügelt durch die Erfindungen und den technologischen Fortschritt, erstrahlt Novelmore als Hoffnungsschimmer in einer Welt, die langsam aber sicher in mittelalterlicher Düsternis versinkt.

Within the city of Novelmore, genius inventor Dario Da Vanci and his friends come up with one bright idea after another. With its inventions and technological advances, Novelmore emerges as the last beacon of hope in a world that is slowly but surely falling deeper into medieval darkness.

Au sein de la cité de Novelmore, le génial inventeur Dario Da Vanci et ses amis ont des idées plus brillantes les unes que les autres. Grâce à ses inventions et à son avance technologique, Novelmore apparaît comme le dernier espoir dans un monde qui sombre lentement mais sûrement dans les ténèbres médiévales.

En la ciudad de Novelmore, el genio inventor Dario Da Vanci y sus amigos tienen una brillante idea detrás de otra. Empoderada por sus inventos y avances tecnológicos, Novelmore emerge como un rayo de esperanza en un mundo que está decayendo lentamente en la oscuridad medieval.

## INVINCIBUS



Die Invincibus ist eine der bisher größten Erfindungen der Da Vancis: Eine unglaublich mächtige Rüstung, die jeden, der sie trägt, unbesiegbar macht. In den falschen Händen wäre sie eine gefährliche und zerstörerische Superwaffe. Deshalb hat Dario Da Vanci Timithor, den Zauberer der Zeit, gebeten, die Rüstung zu verstecken. Damit sie niemand jemals finden kann, soll er sie an einen unbekanntem Ort zu einer unbekanntem Zeit bringen.

The invincibus is one of the Da Vanci's greatest inventions yet: an incredibly powerful armor that makes anyone who wears it invincible. It would be dangerous and destructive if it ever fell into the wrong hands. Therefore, Dario asked Timithor, a temporal wizard, to hide it in an undisclosed space and time so no one could find it.

L'invincibus est l'une des plus grandes inventions de la famille Da Vanci: une puissante armure qui rend absolument invincible la personne qui la porte. Ce serait une arme dangereuse et destructrice si elle tombait entre de mauvaises mains. C'est pourquoi Dario a demandé à Timithor - un sorcier temporel - de la cacher dans un lieu et dans un temps tenus secrets, pour que personne ne puisse la trouver.

EL invincibus es una de las mejores invenciones de la familia Da Vanci: una increíble y poderosa arma que hace a cualquier persona que la lleve absolutamente invencible. Sería un arma muy peligrosa y destructiva si cae en las manos equivocadas. Por eso, Dario le pide a Timitior (un mago del tiempo) que la esconda en un espacio y tiempo desconocido para que nadie pueda encontrarla.

## BRODY

**B**rody, der Sohn von Bayron, ist die einzige Stimme der Vernunft in Burnham. Eines Tages verlässt Brody Burnham und geht alleine auf Reisen. Bei seiner Rückkehr ist er fest entschlossen, aus dem chaotischen Haufen der Burnham Raiders mehr zu machen und seinen Vater stolz zu machen.

**P**rodigal son Brody is Burnham's only voice of reason. On his return he is determined to turn the chaotic bunch of Burnham Raiders into something more and make his father proud.

**B**rody est le fils prodigue de Burnham, et aussi sa seule voix de la sagesse. À son retour, il est déterminé à transformer la bande de hors-la-loi Burnham Raiders, pour rendre son père fier de lui.

**E**l hijo pródigo Brody es la única voz de la razón de Burnham. A su regreso, él está decidido en convertir en algo más al caótico grupo de los Bandidos de Burnham y hacer que se enorgullezca su padre.

## ARWYNN

**P**rinz Arwynn ist der Erbe des Throns von Novelmore. Durch seine königlichen Adern fließt jedoch Abenteuerblut. Wann immer es möglich ist, schleicht er sich davon, um aufregende Abenteuer zu erleben.

**H**eir to the Novelmore throne, Prince Arwynn has adventurer blood coursing through his royal veins, leading him to break royal protocol whenever possible to live the life of a true adventurer.

**H**éritier du trône de Novelmore, le prince Arwynn a du sang d'aventurier qui coule dans ses veines royales, et il tente d'échapper aux protocoles dès qu'il le peut pour vivre la vie d'un vrai aventurier.

**H**eredero al trono de Novelmore. El príncipe Arwynn tiene sangre aventurera corriendo por sus venas reales, esto hace que se escape de todo el protocolo cuando puede para vivir la vida de un auténtico aventurero.



Die Ritter von Novelmores sind die treuen Beschützer Novelmores und des umliegenden Königreichs Noveldor. Dank innovativer Waffen, Erfindergeist und kluger Taktik sind sie für jede Herausforderung gewappnet.

The Knights of Novelmores are the loyal protectors of Novelmores and the Noveldor realm. Armed with innovative weaponry and inventive tactics, they are always able to surprise whoever dares to challenge them.

Les Chevaliers de Novelmores sont de loyaux protecteurs de Novelmores, et du grand royaume Novelmores. Equipés avec des armes innovantes, et grâce à leurs tactiques inventives, ces chevaliers surprennent toujours les ennemis qui oseraient les défier.

Los Caballeros de Novelmores son protectores leales del reino de Novelmores. Equipados con armas innovadoras y con creativas tácticas, siempre sorprenden a cualquiera que les desafíe.

## GWYNN

Furchtlos, hartnäckig, rebellisch – das ist Gwynn. Sie ist fest entschlossen sich den mittelalterlichen Regeln zu widersetzen, um als erste Ritterin von Novelmores in die Geschichte einzugehen.

Fearless and tenacious, Gwynn is a rebel and determined to challenge medieval rules in order to take her place as Novelmores's first female Knight, whatever the cost.

Courageuse et obstinée, Gwynn est rebelle et déterminée à défier les lois médiévales pour devenir la première femme Chevalier de Novelmores.

Sin miedo y tenaz. Gwynn es una rebelde y está decidida a cambiar las normas medievales para convertirse a toda costa en la primera mujer Caballero de Novelmores.

## DARIO DA VANCI

Dario ist ein echter Visionär. Als kreatives Genie ist er dazu bestimmt, Novelmores mit seinen brillanten Ideen und revolutionären Erfindungen weiterzubringen und für immer zu verändern.

Visionary Dario is the creative genius and inventor destined to change Novelmores forever with his brilliant insights and revolutionary inventions.

Dario est un visionnaire, un génie créatif et inventeur destiné à changer Novelmores pour toujours grâce à ses idées brillantes et à ses inventions révolutionnaires.

Dario es un visionario y creativo genio inventor destinado a cambiar Novelmores para siempre con sus brillantes ideas e inventos revolucionarios.



Die Burnham Raiders sind ein wilder Haufen von Gesetzlosen und Banditen, die sich durch ihre Faszination für das Feuer verbunden fühlen. Wo auch immer sie auftauchen, lässt ein loderndes Feuer nicht lange auf sich warten. Ihre Hauptstadt Burnham liegt in einem riesigen Vulkankrater.

The Burnham Raiders are a wild bunch of outlaws and bandits united around a burning desire to start fires. Wherever they go things just tend to go up in flames. Their main city of Burnham is built inside a huge volcanic crater.

Les Burnham Raiders sont une bande de hors-la-loi et de bandits réunis pour mettre le feu sur leur chemin. Partout où ils vont, tout a tendance à s'enflammer. Leur cité de Burnham est construite à l'intérieur d'un immense cratère volcanique.

Los Bandidos de Burnham son un grupo salvaje de forajidos unidos por el deseo de incendiar cosas. Allá donde van acaba en llamas. Su ciudad Burnham está construida dentro de un cráter volcánico.

## KAHBOOM

Kahboom ist der Meister des Unfugs. Er verursacht Zerstörung und Chaos, wo es nur geht. Den größten Spaß hat er daran, zu zünden und mit Feuerwerkskörpern zu experimentieren.

Rebellious court jester Kahboom is the master of mischief. He is happiest creating chaos and destruction and setting the world ablaze with fireworks.

Bouffon de cour anarchique, Kahboom est un maître en malice pyromane : il est heureux de semer le chaos et la destruction, mettant le monde à feu et à flamme avec ses explosifs et ses feux d'artifice.

El anárquico bufón de la corte Kahboom es un pirómano maestro de las travesuras. Es feliz creando el caos y la destrucción, incendiando el mundo con sus explosivos y fuegos artificiales.

## BAYRON

Der rachsüchtige Kriegsherr Bayron wurde vor langer Zeit aus Novelmoo verbannt und ist heute der Anführer der Burnham Raiders. Kahboom, sein Handlanger, stachelt Bayron stets an, das nächste Feuer zu legen.

Exiled from Novelmoo a long time ago, vengeful Warlord Bayron is now the fiery leader of the Burnham Raiders. His passion and burning rage are easily fueled by his sidekick Kahboom.

Exilé de Novelmoo depuis très longtemps, le seigneur de guerre Bayron est devenu le leader fougueux des Burnham Raiders. Ses tendances pyromanes et sa colère enflammée sont facilement attisées par son compagnon Kahboom.

Exiliado de Novelmoo hace mucho tiempo. El vengativo Bayron es ahora el feroz líder de los Bandidos de Burnham. Sus tendencias pirómanas y su furia están alimentadas por su compañero Kahboom.





# WARNING: CHOKING HAZARD

Contains a small ball and small parts.  
Not for children under 3 years.

”Ne concerne que les USA“

Wichtige Unterlagen, bitte sorgfältig aufbewahren!  
Important: Please keep these instructions for future reference!  
Documents importants, à conserver soigneusement!  
Belangrijke documenten, bewaar deze zorgvuldig!

Abbildungen können vom Original abweichen.  
Product may differ from image shown.  
Les illustrations peuvent différer de l'original.  
Afbeeldingen kunnen verschillen van het werkelijke artikel.

2

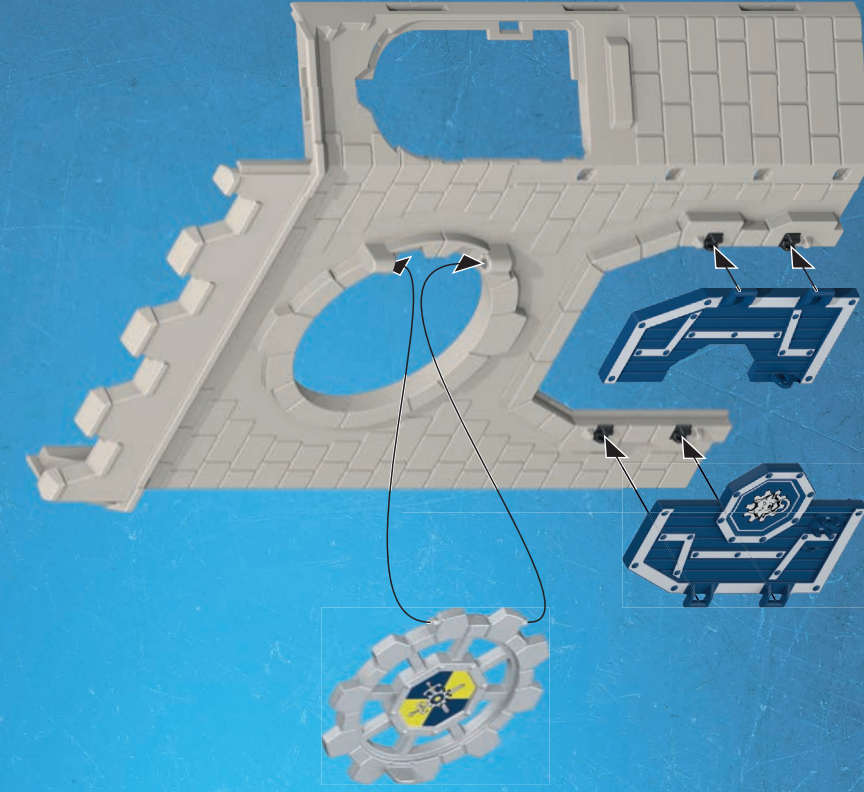

1

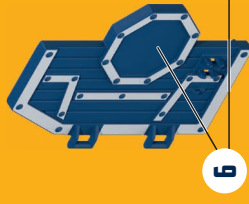
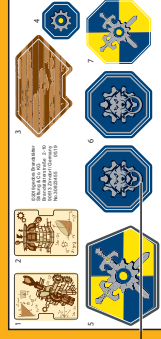
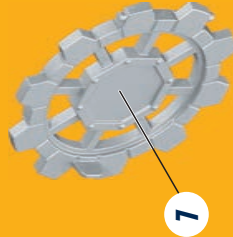
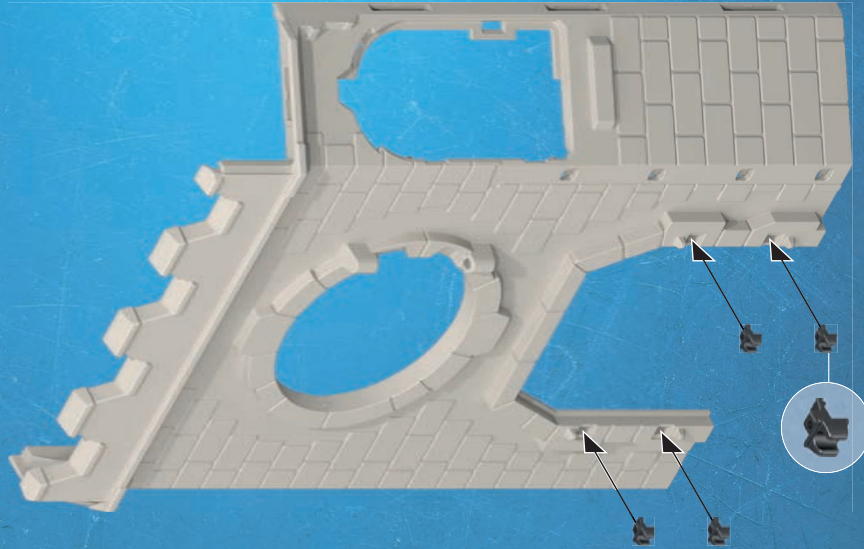

4

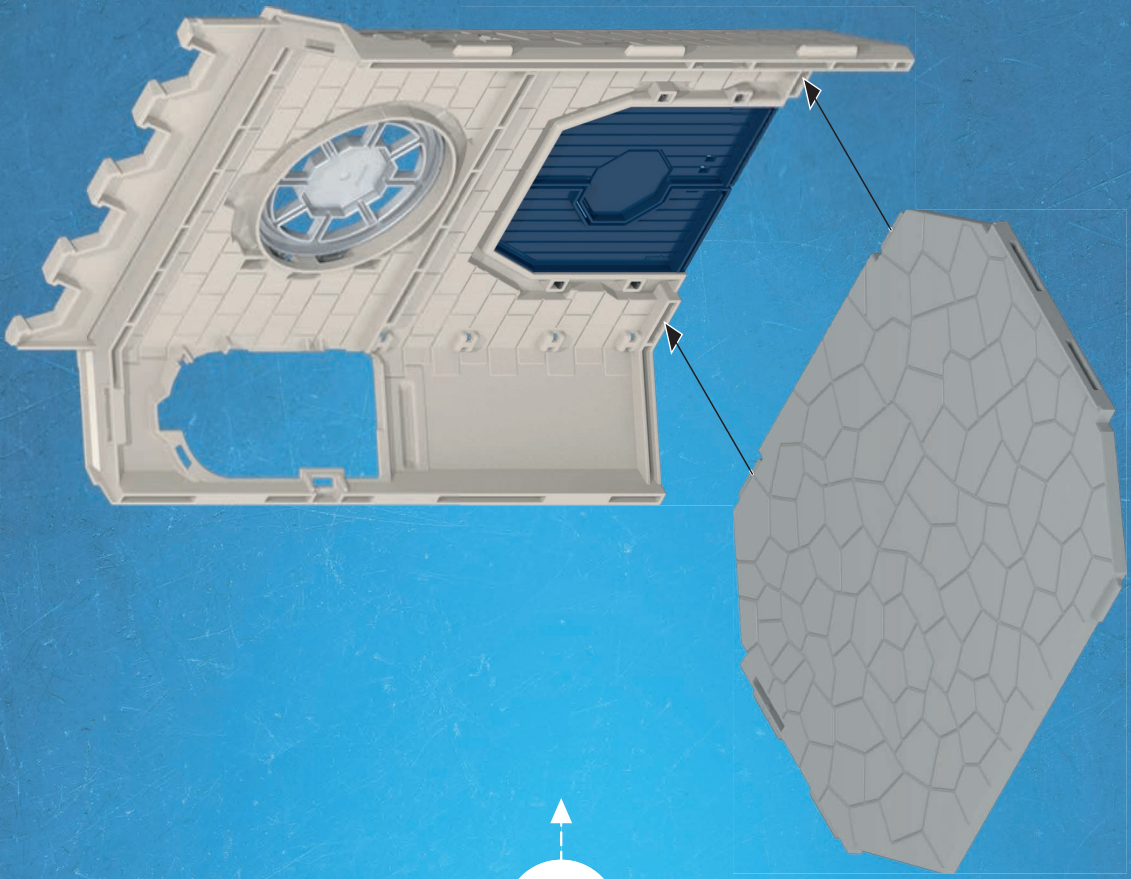

3

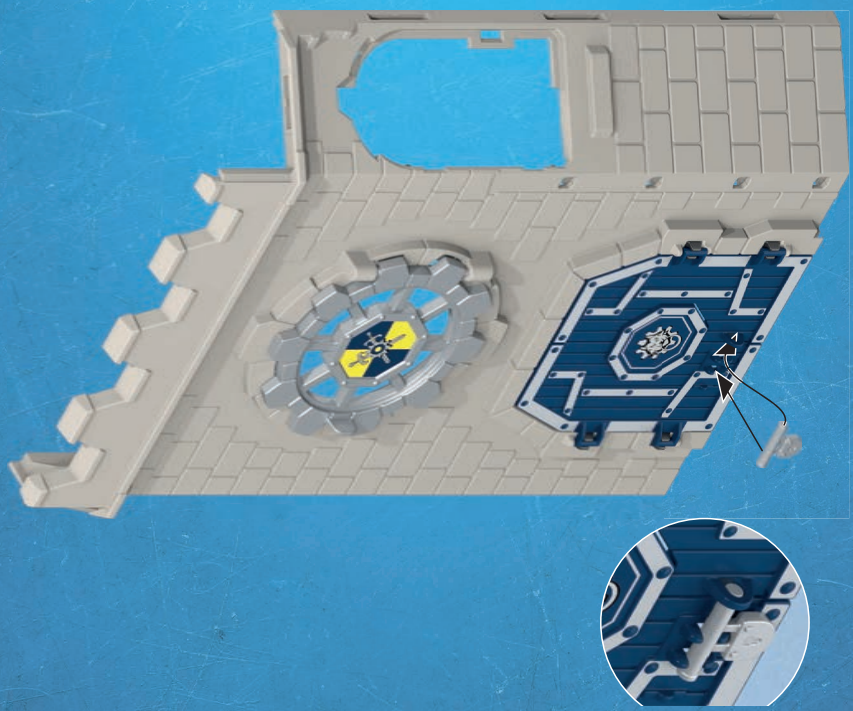

5

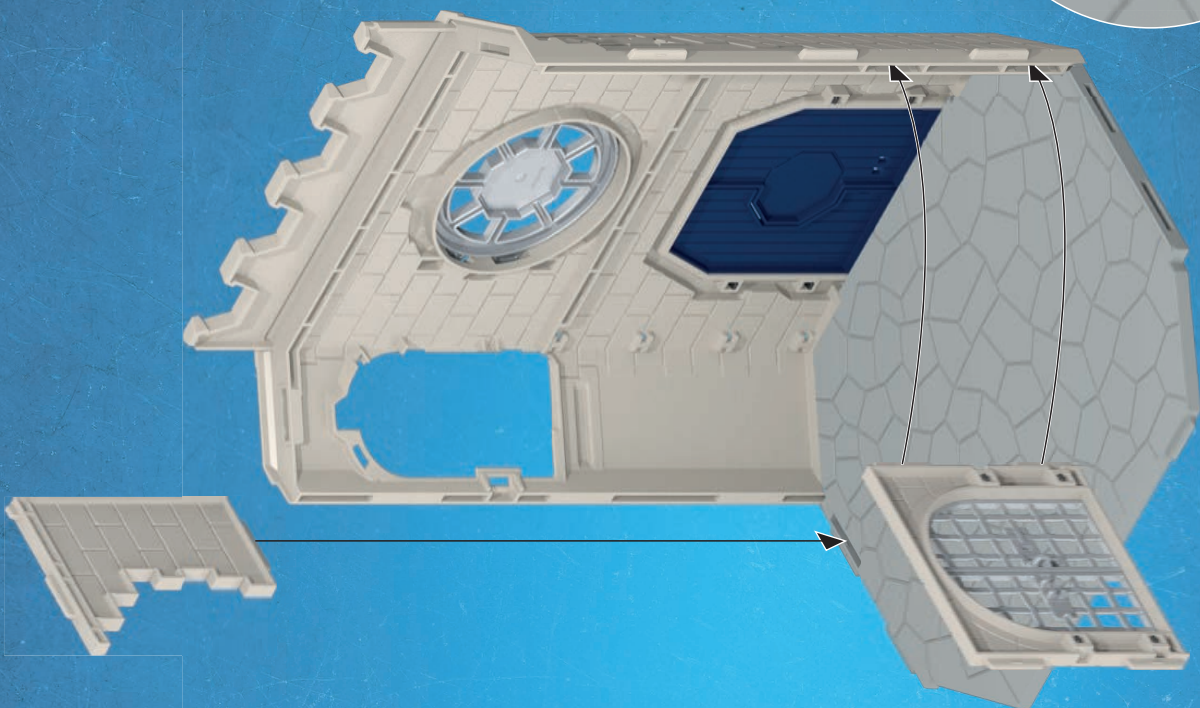
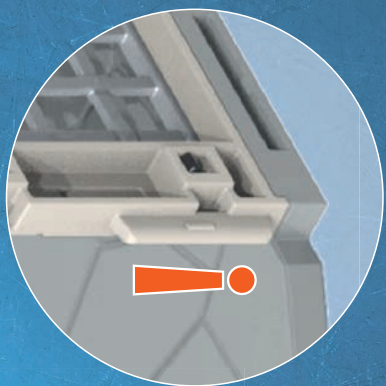

1

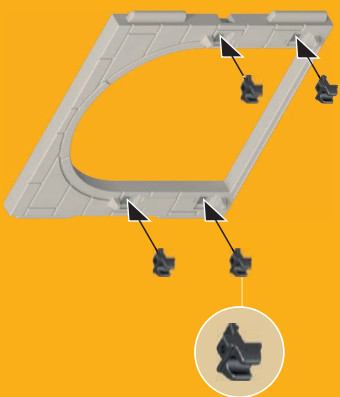

2

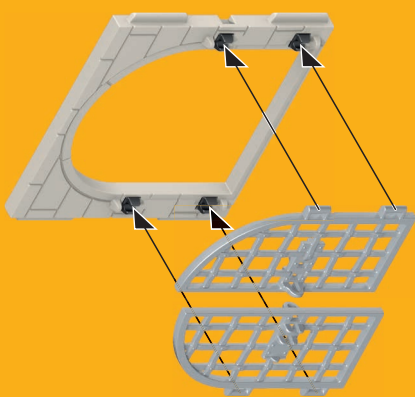

3

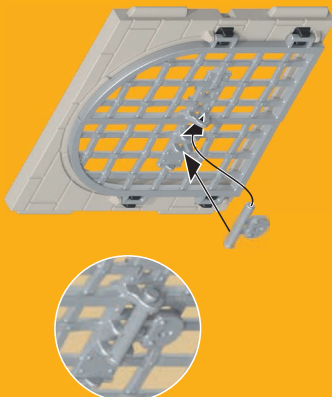



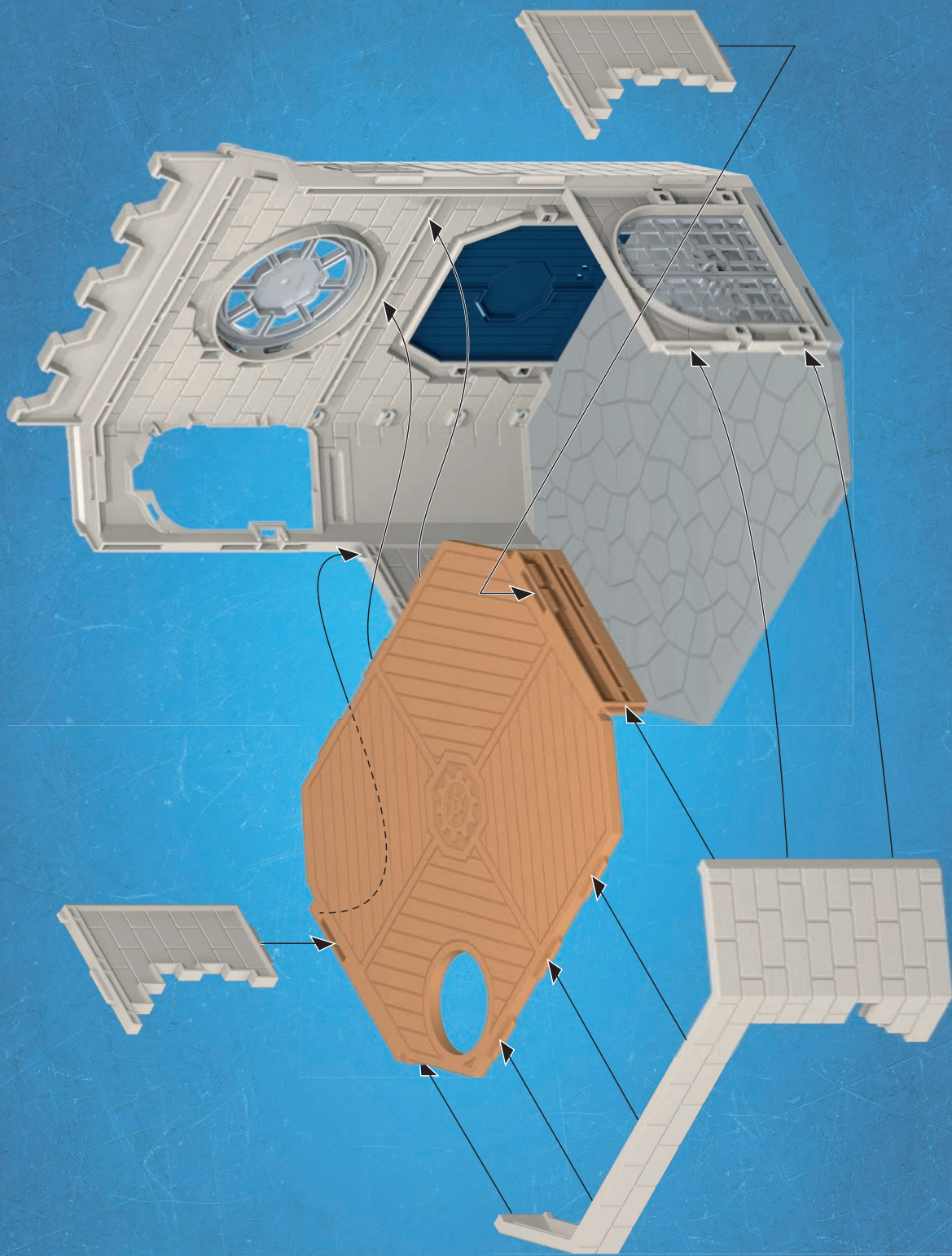

7

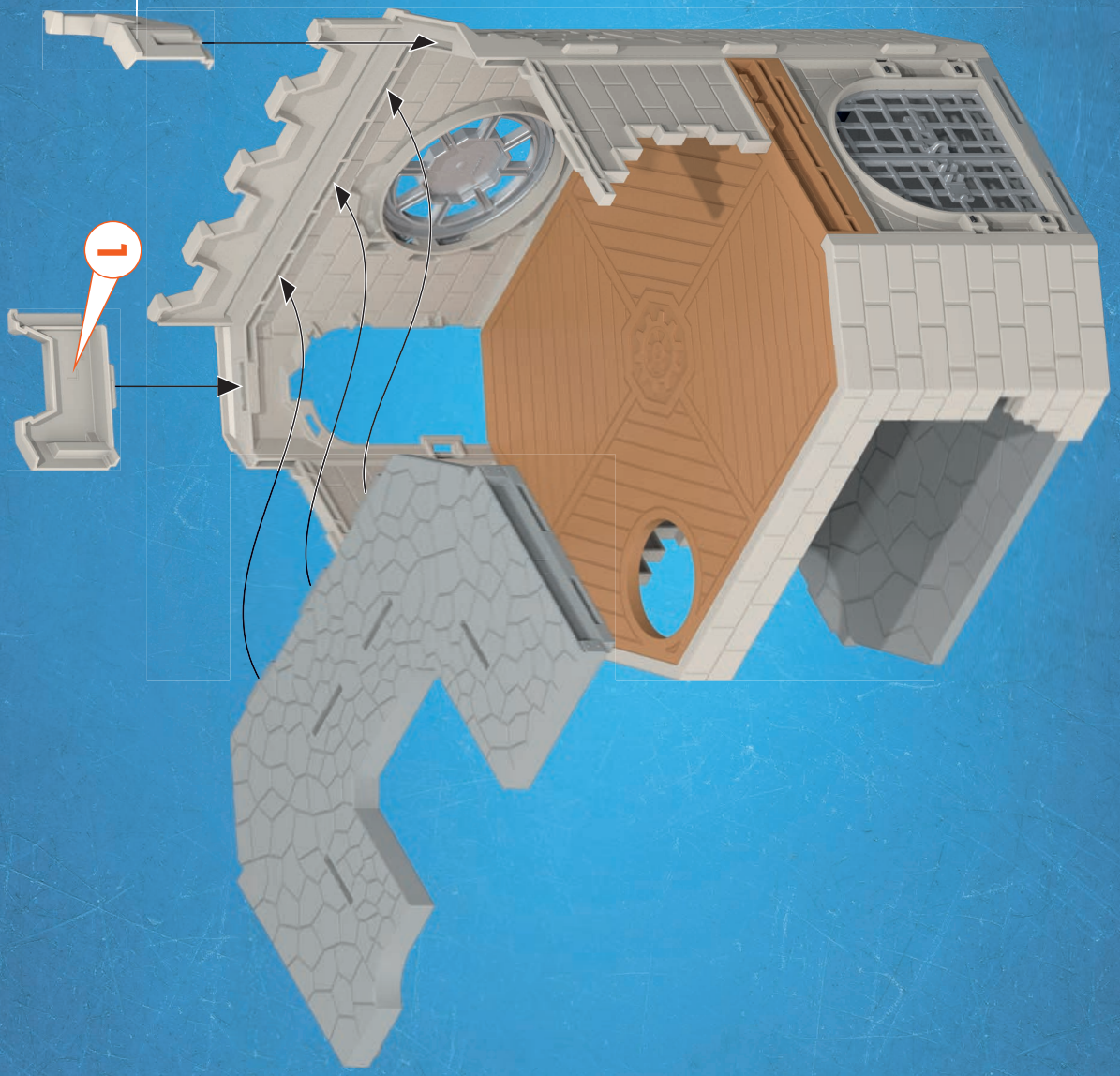
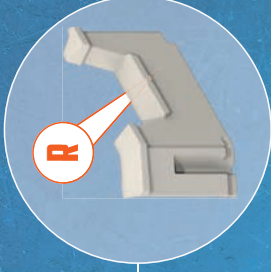

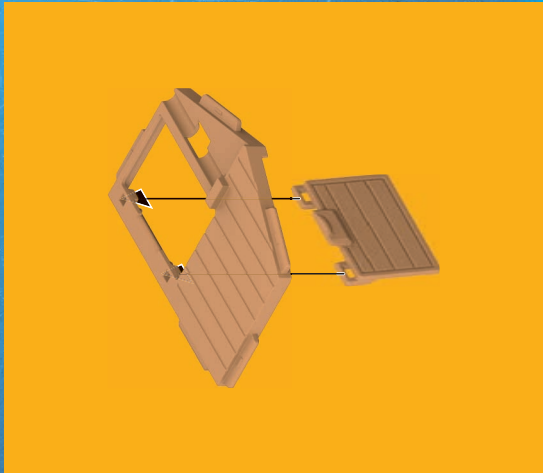
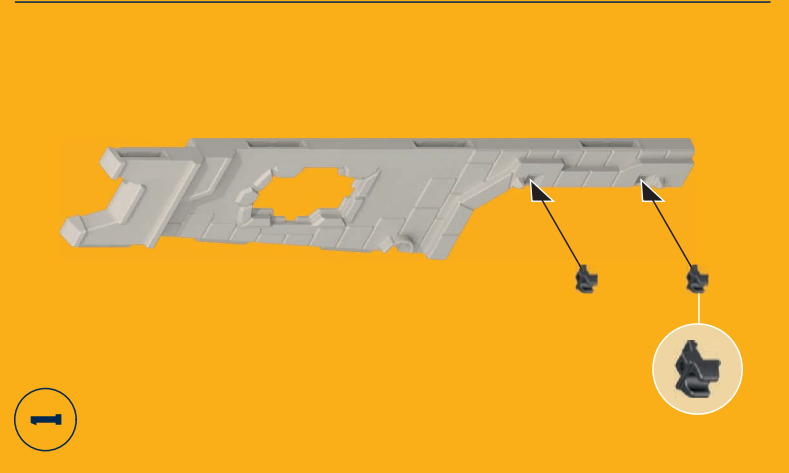
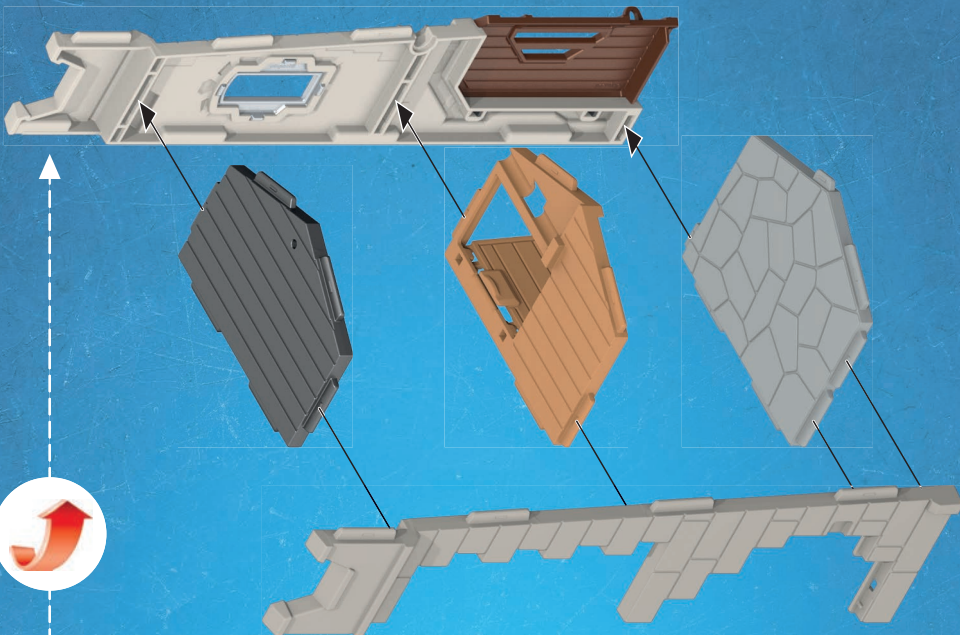

10

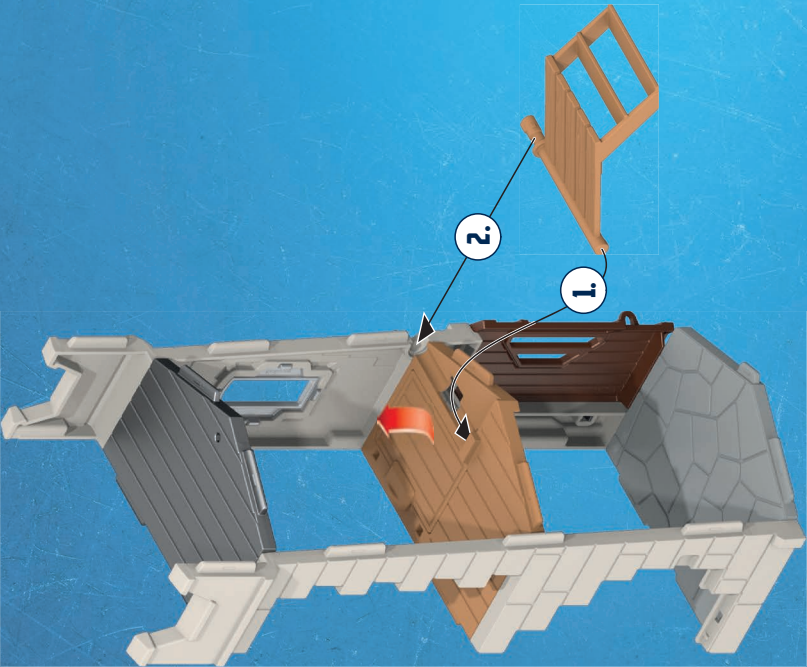

9

11

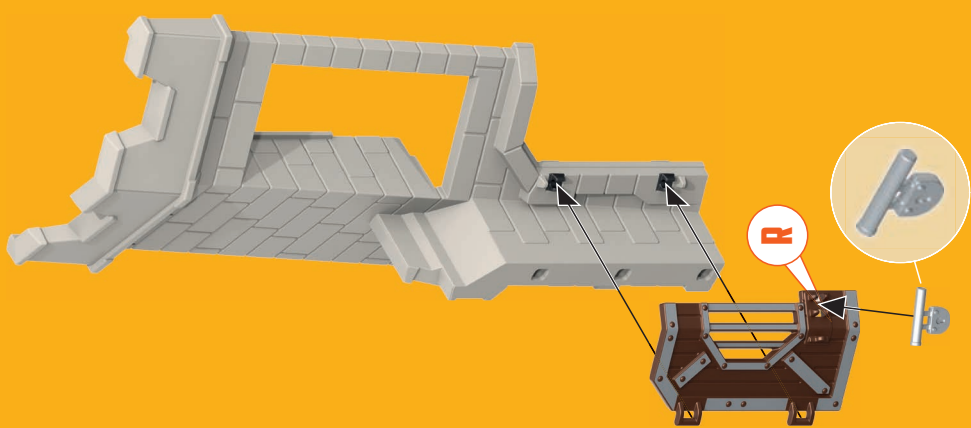
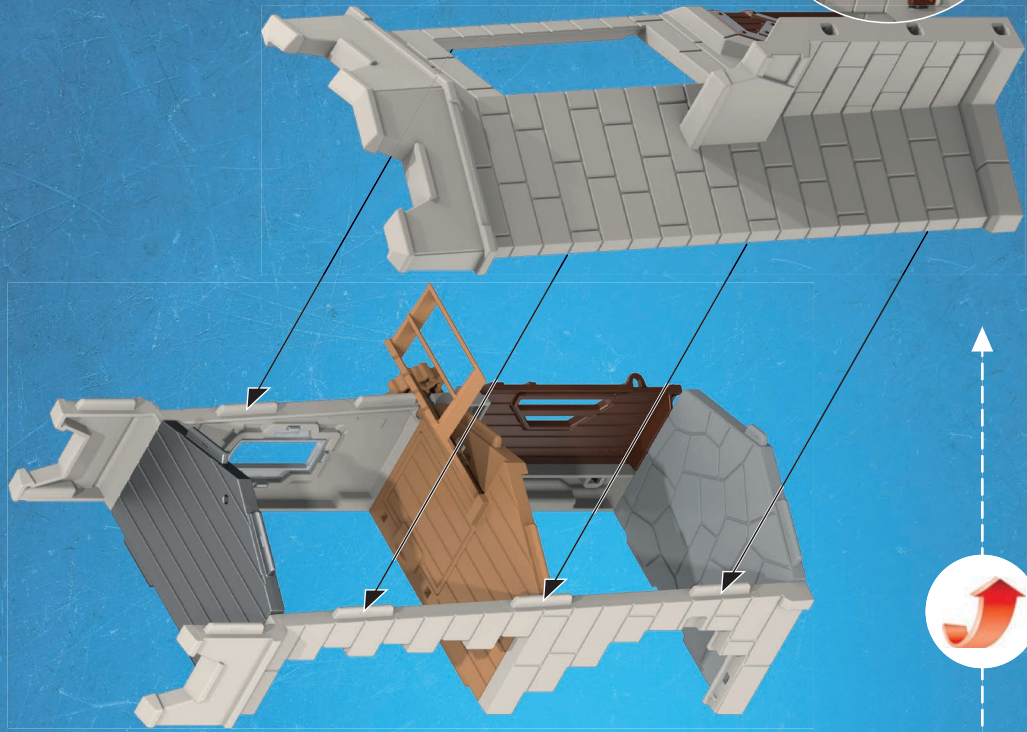
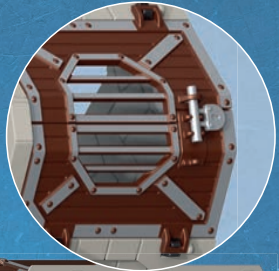

2

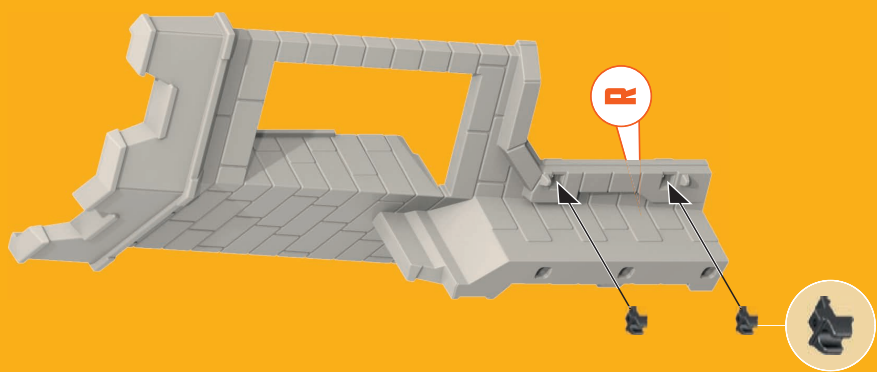

1

12

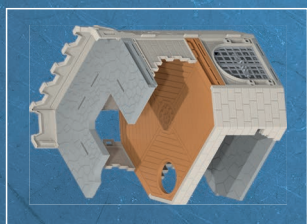
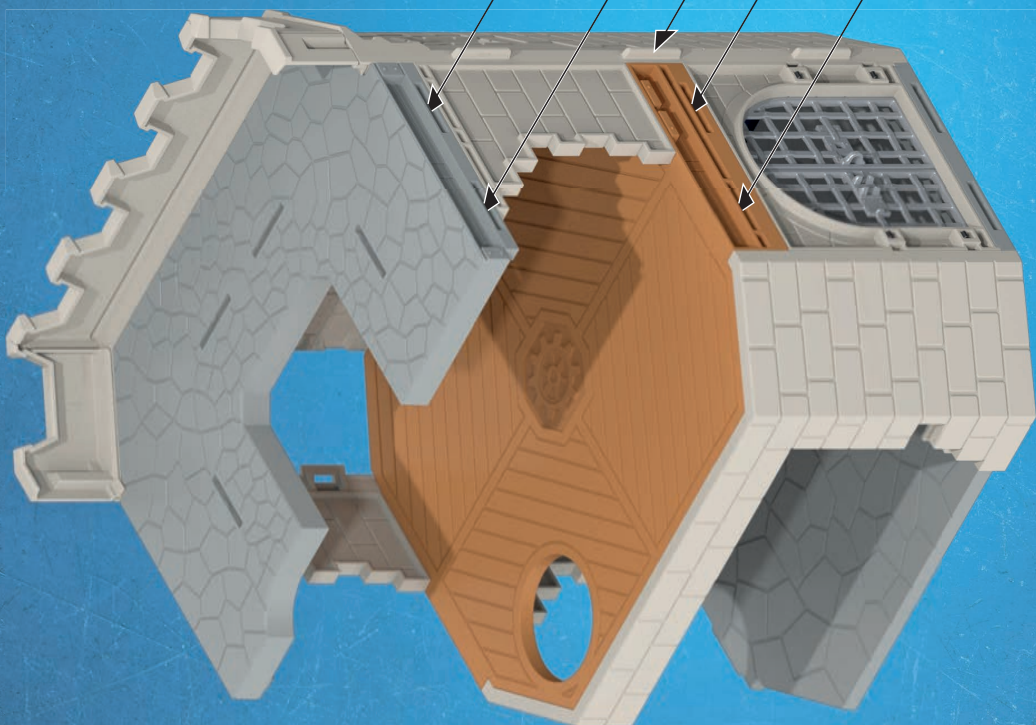
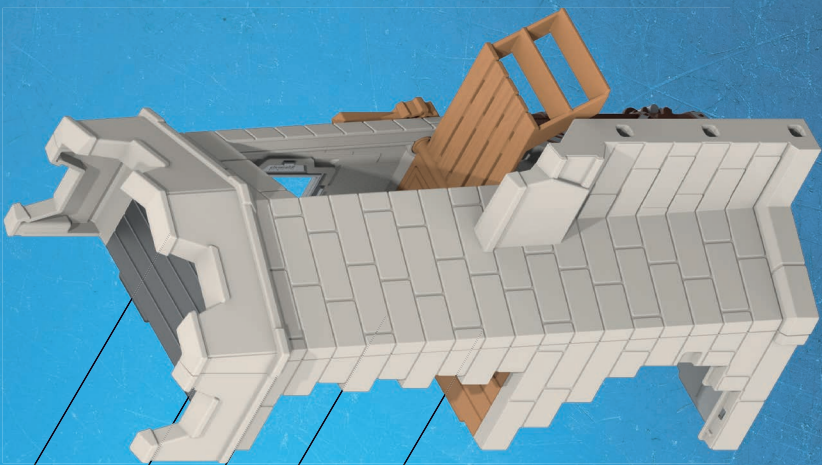
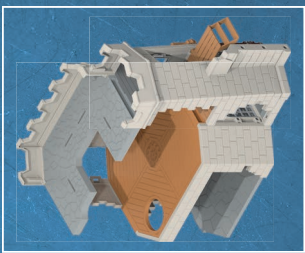

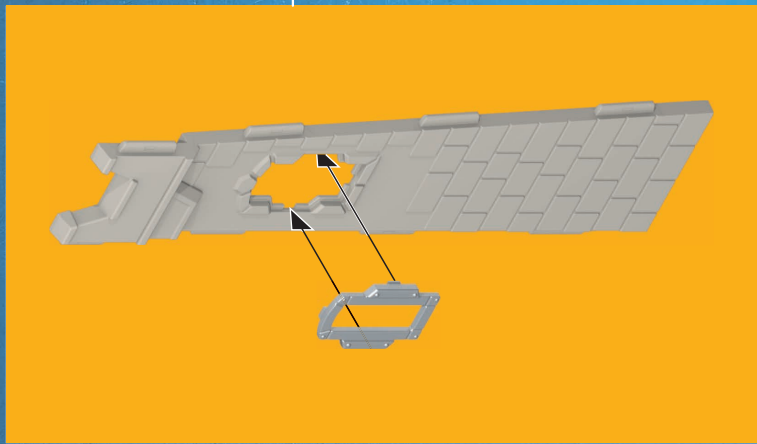
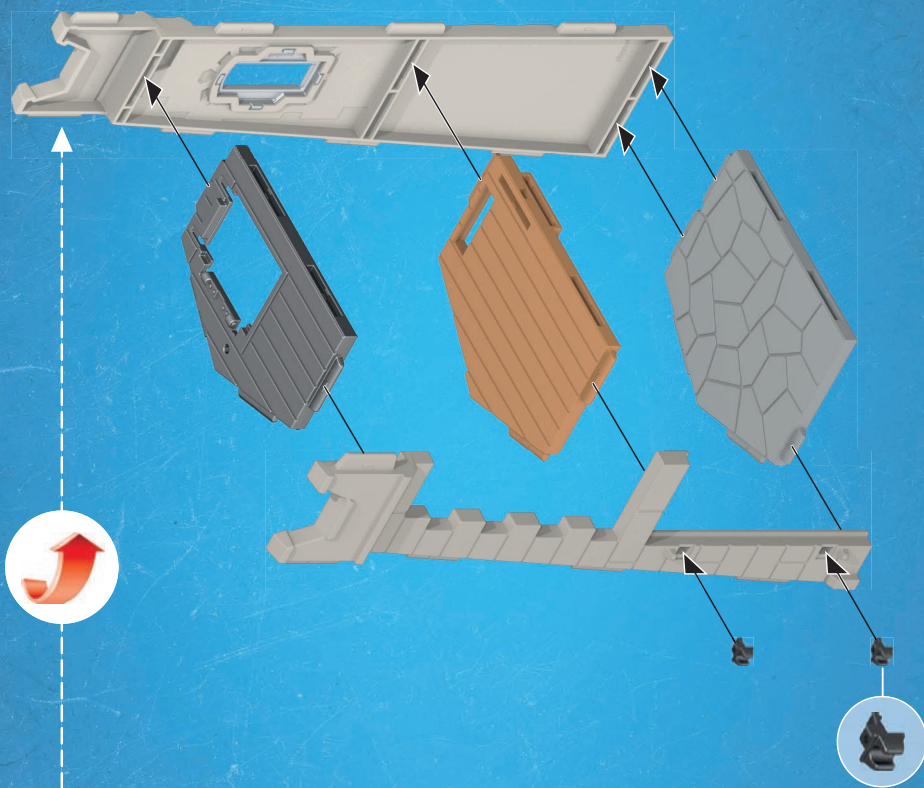

14

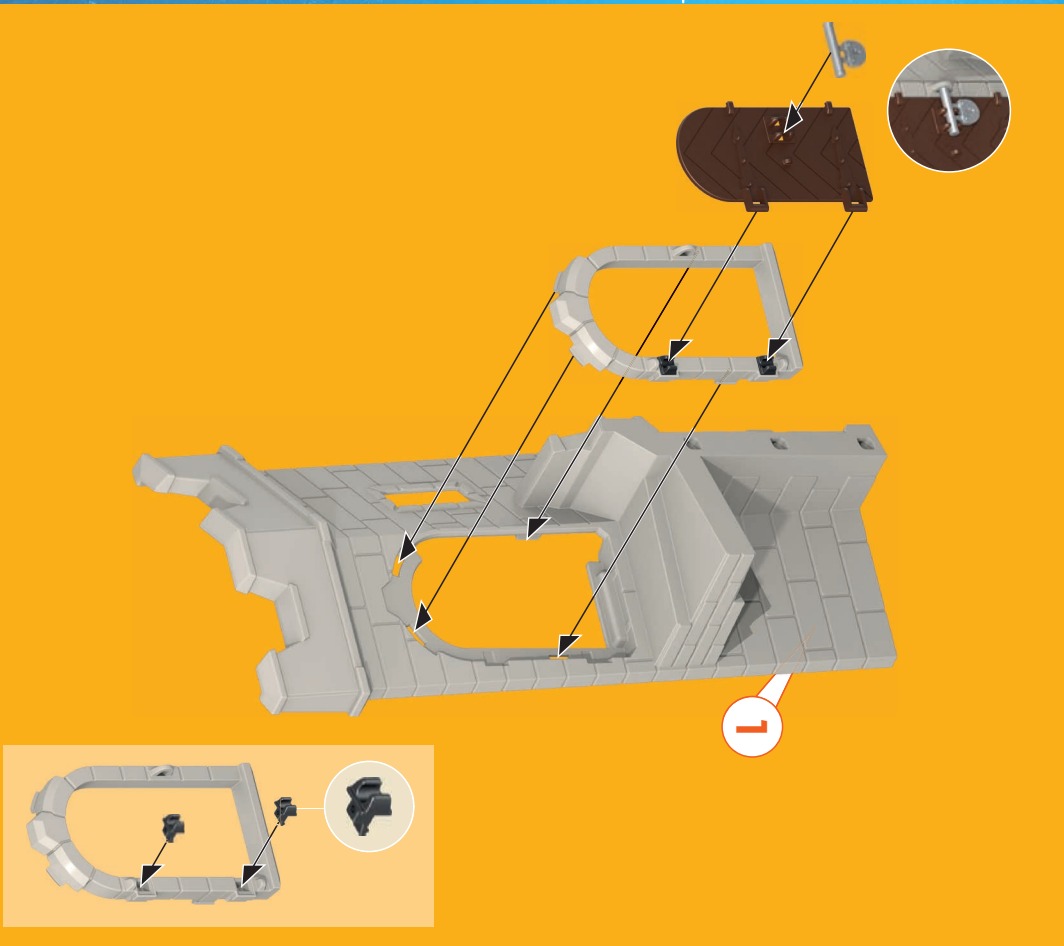
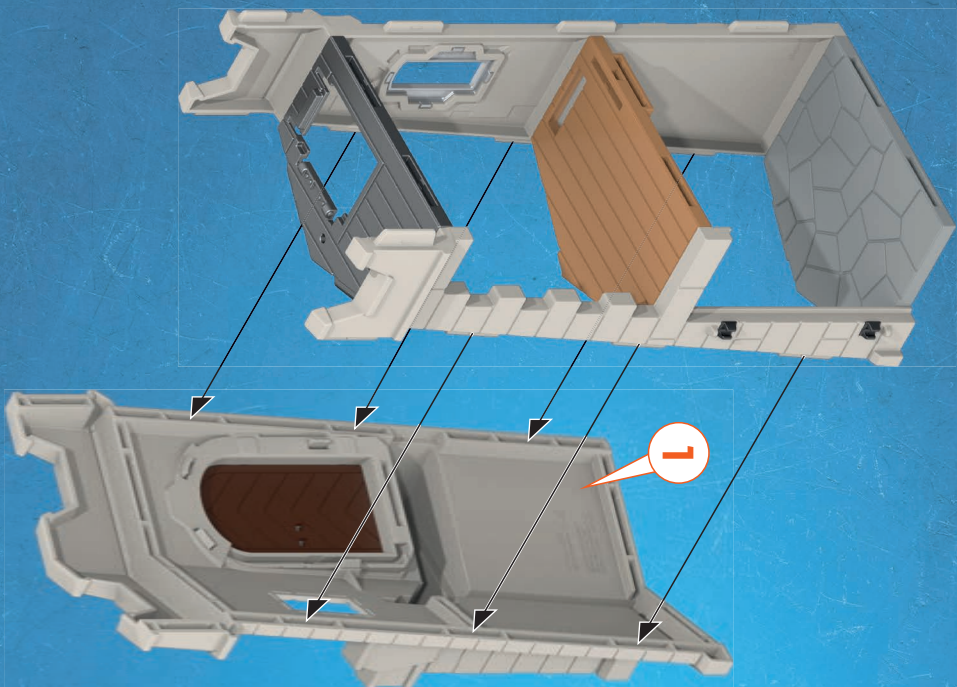



16

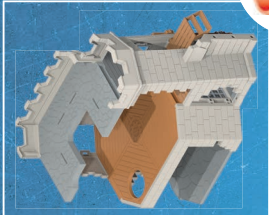
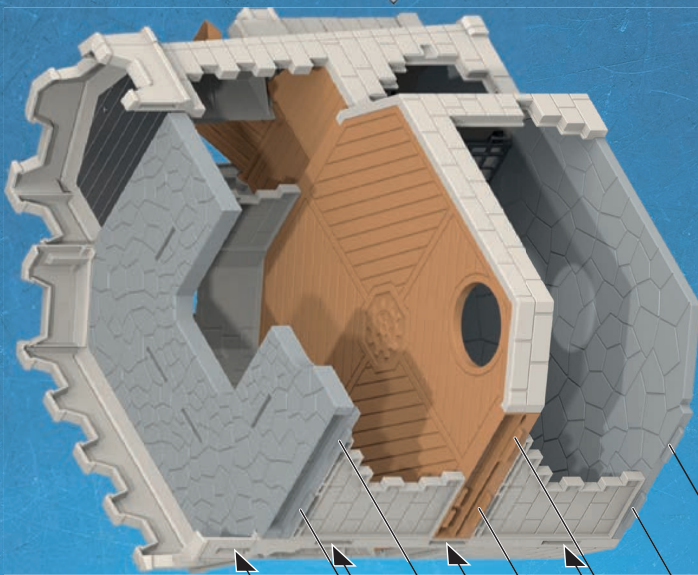

15

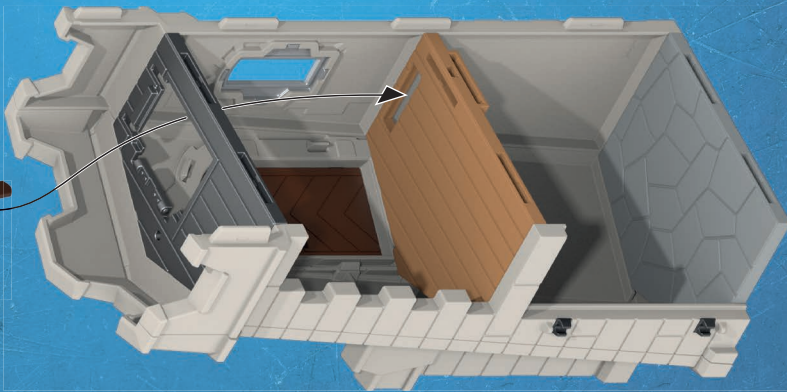

17

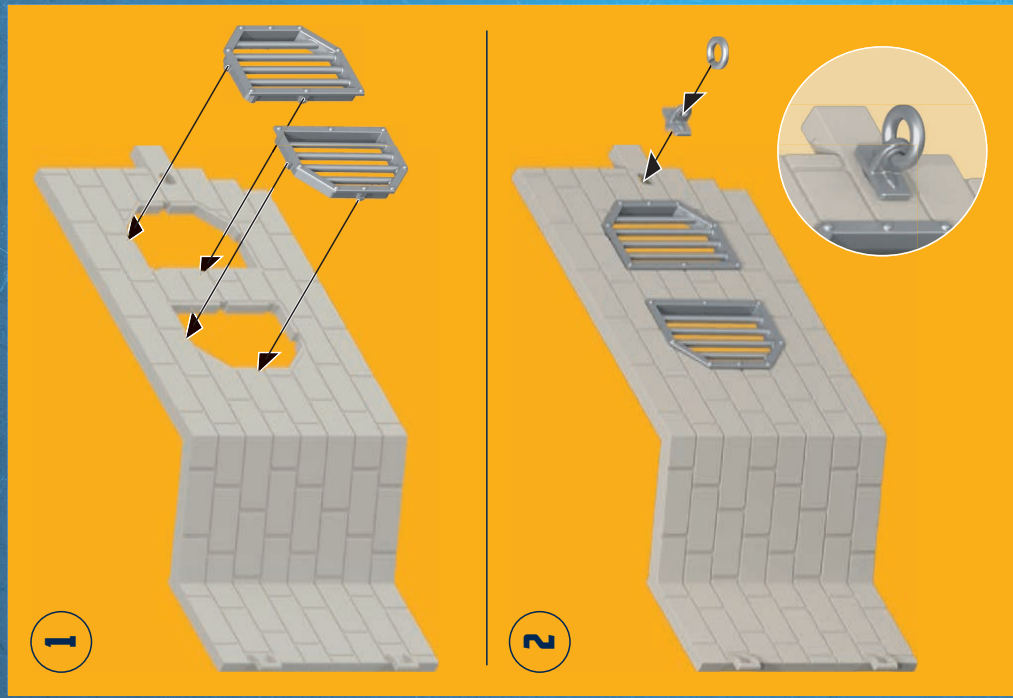
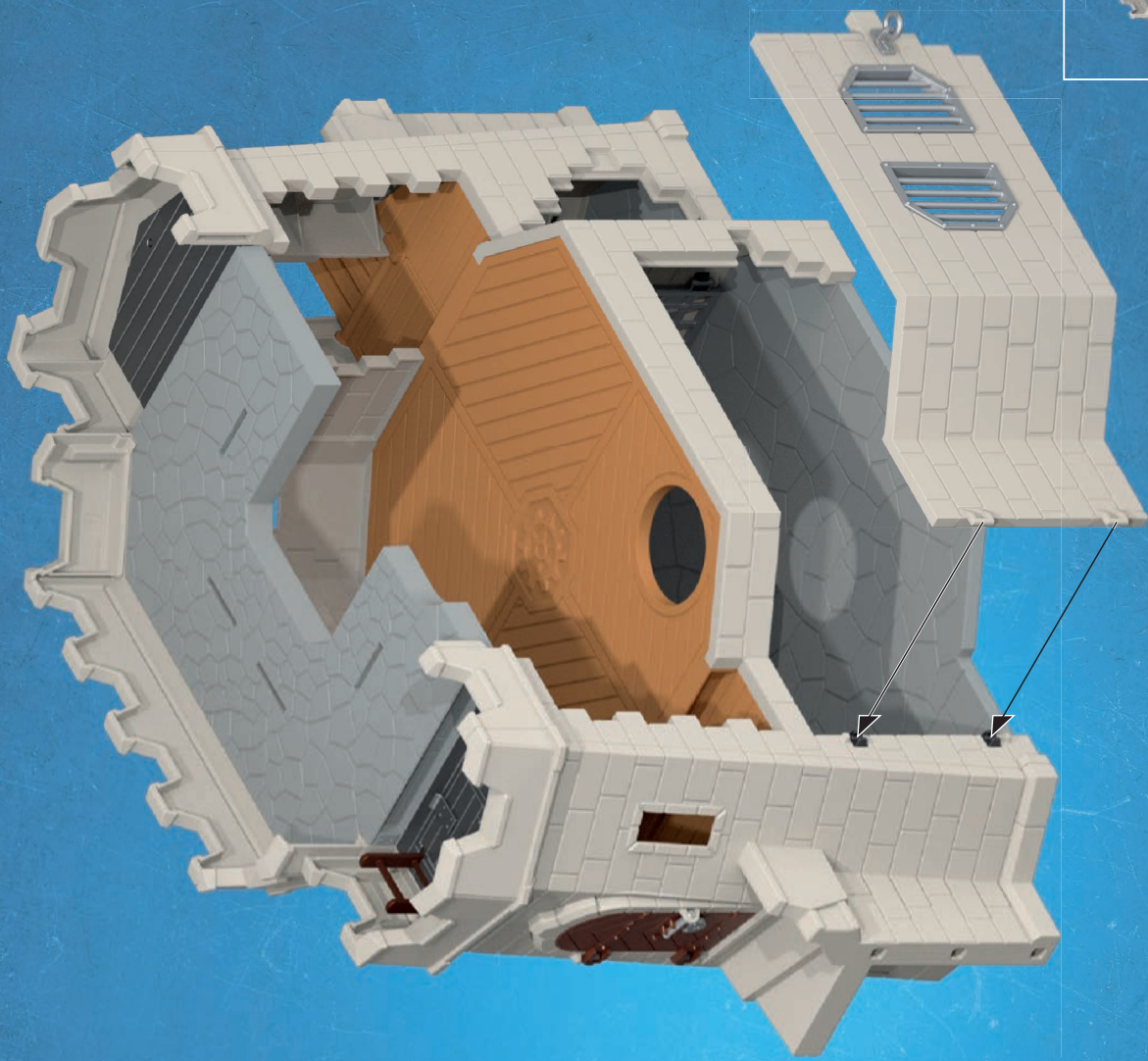

19

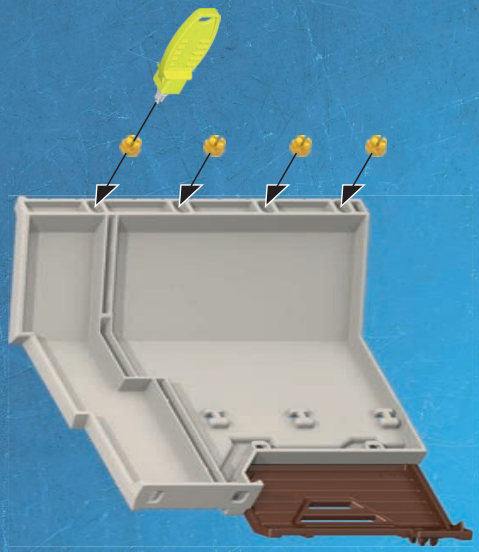

21

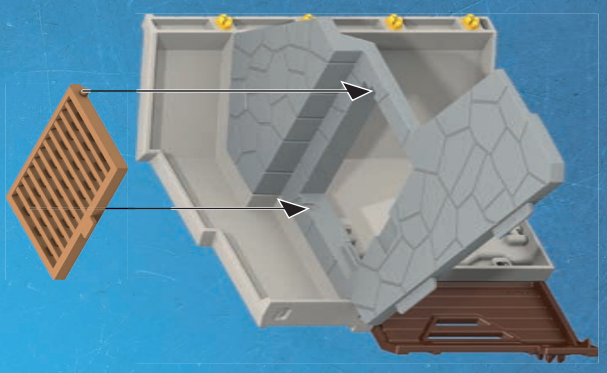

18

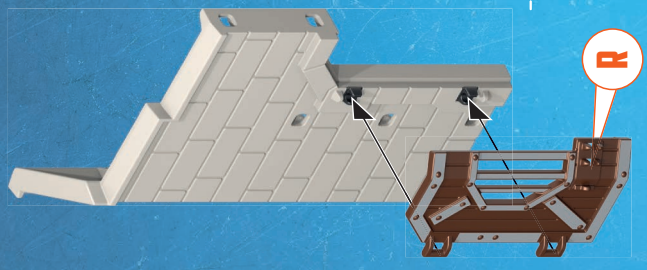
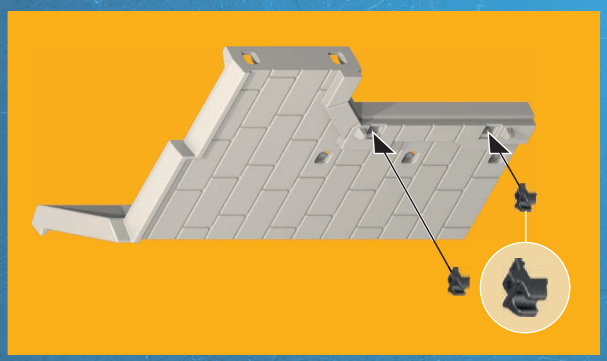

20

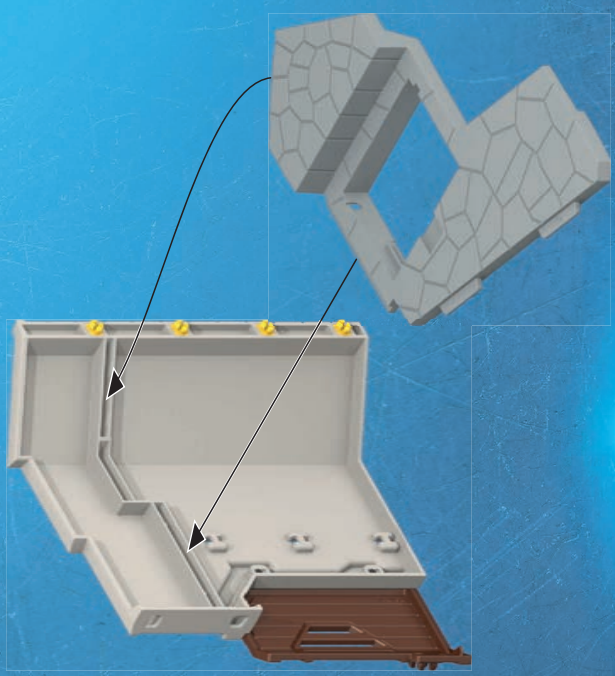

22

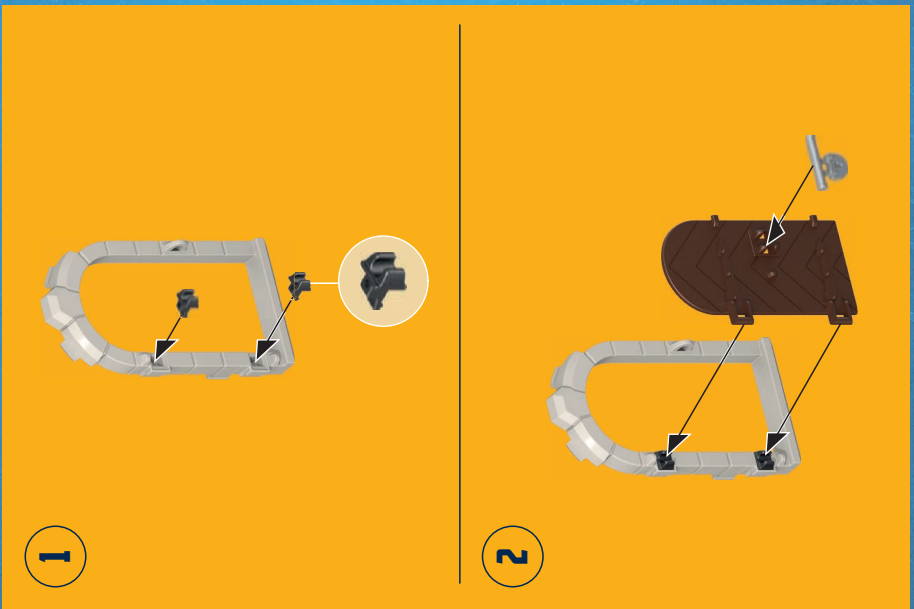

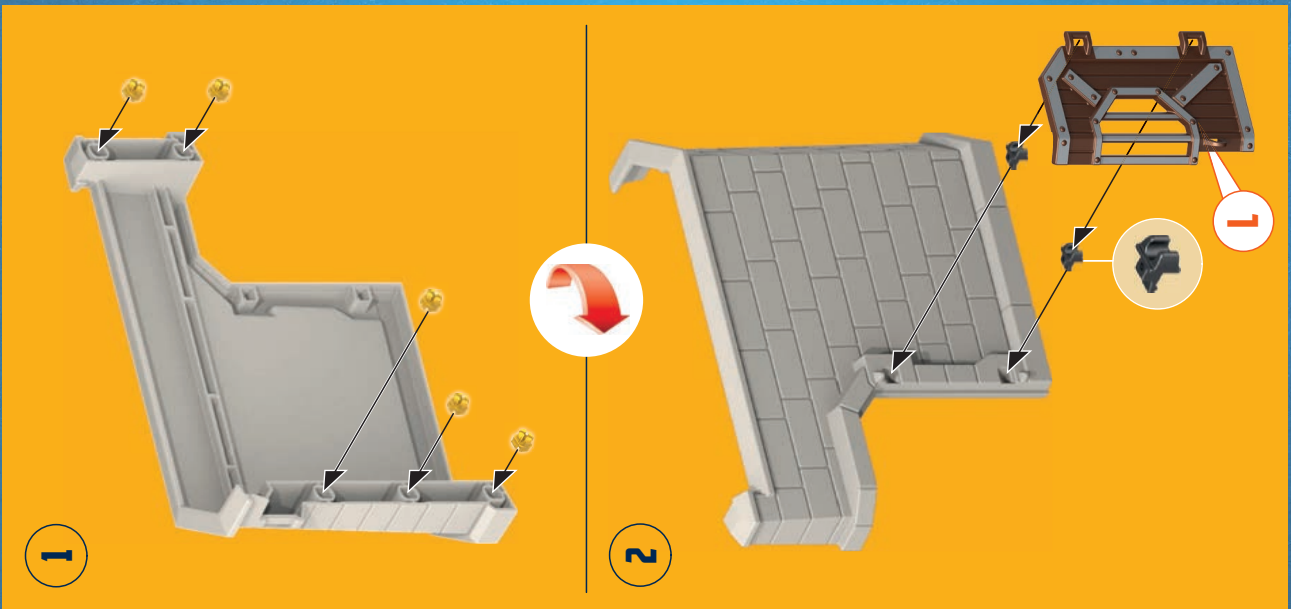
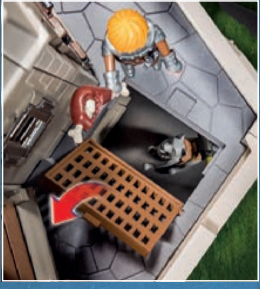

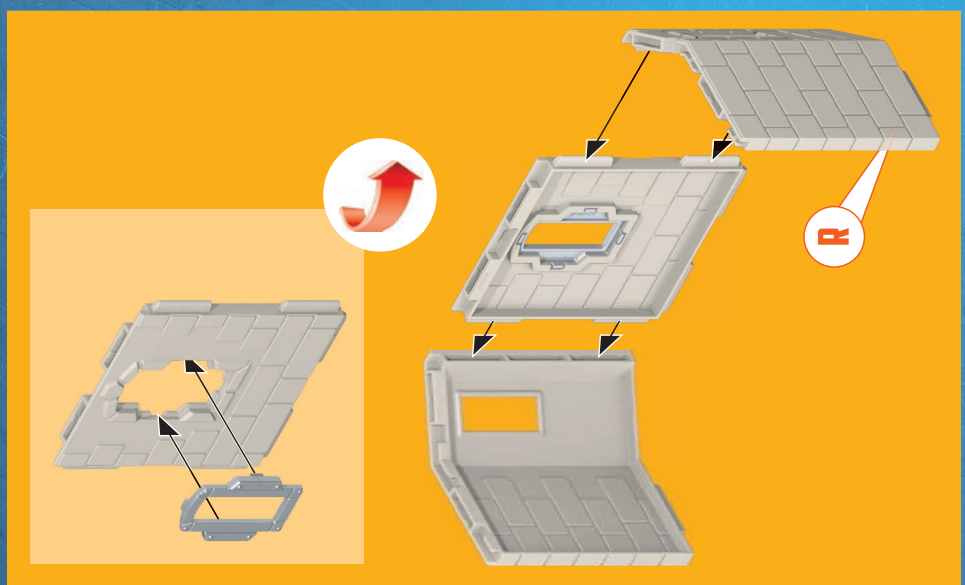

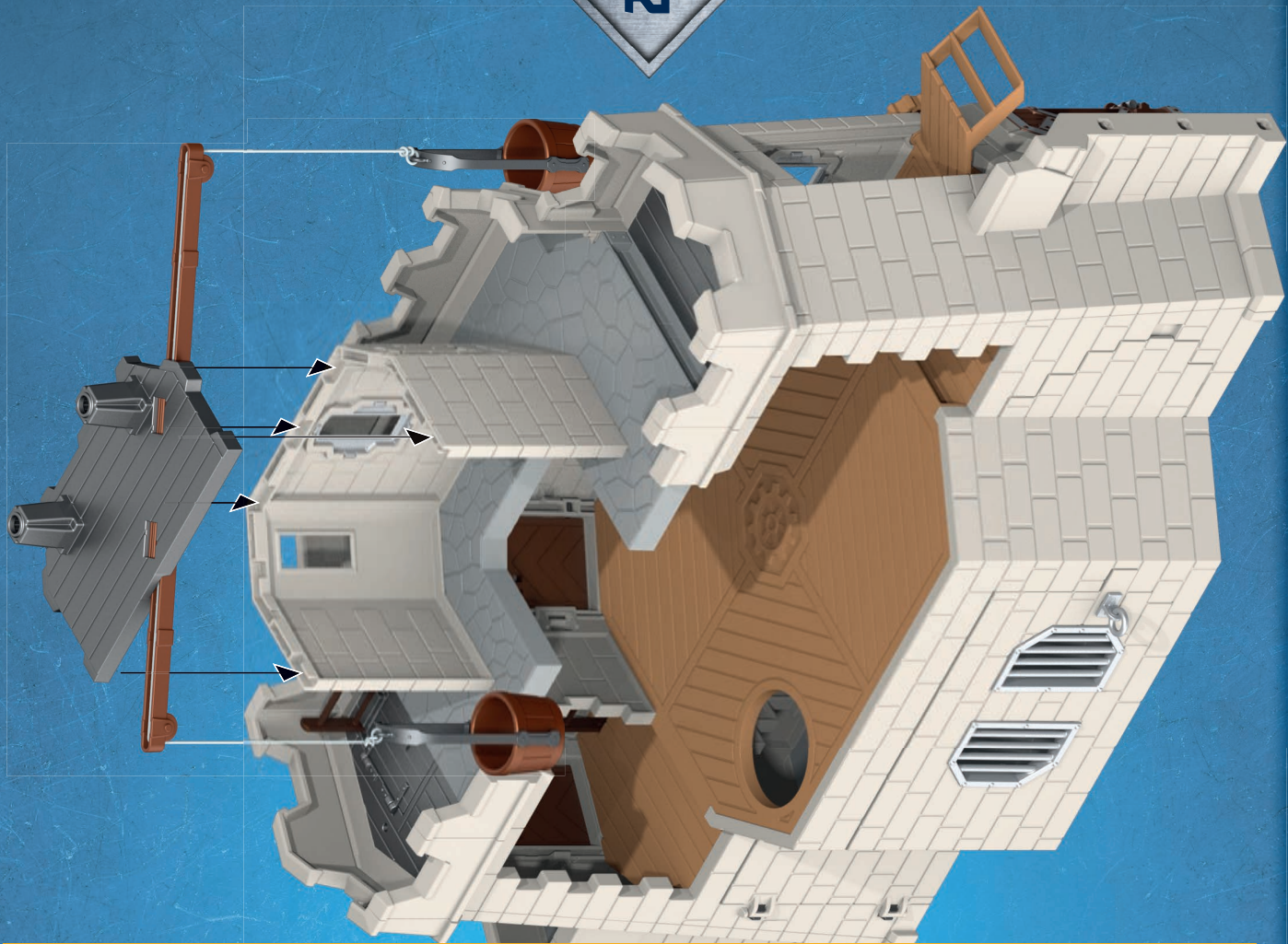

2

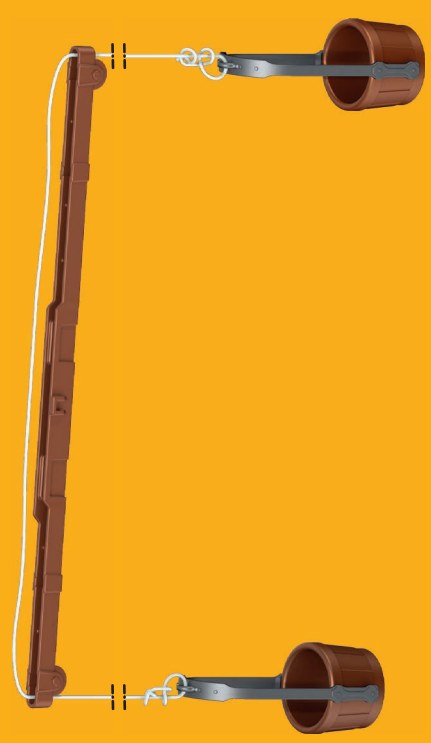

1

2X

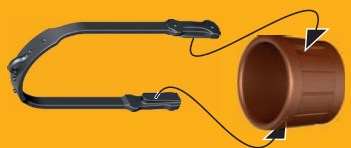

3

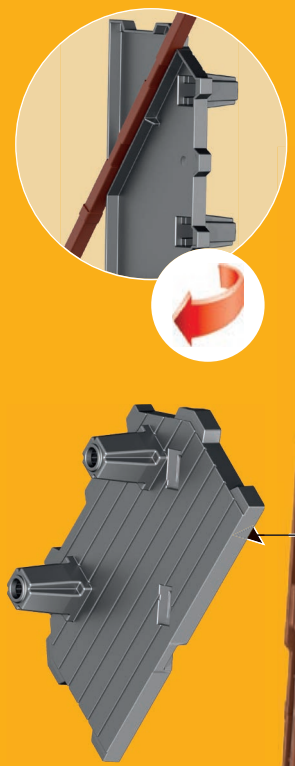

**DE AT CH LU BE** ACHTUNG! Nur mitgelieferte PLAYMOBIL Geschosse verwenden. Nicht auf Augen oder Gesicht zielen.

**US GB CA MT IE** WARNING! Only use the PLAYMOBIL projectiles supplied. Do not aim at eyes or face.

**FR CA BE LU CH** ATTENTION! Seulement utiliser les projectiles PLAYMOBIL fournis. Ne pas viser les yeux ou le visage

**ES MX** ¡ADVERTENCIA! Utiliza únicamente los proyectiles PLAYMOBIL suministrados. No apuntar a los ojos ni a la cara. **NL BE** WAARSCHUWING! Uitsluitend meegelerverde PLAYMOBIL delen gebruiken. Niet op ogen of gezicht richten.

**IT CH** AVVERTENZA! Usare soltanto i proiettili PLAYMOBIL in dotazione. Non mirare agli occhi o al viso.

**PT** ATENÇÃO! Usar apenas os projécteis PLAYMOBIL juntamente fornecidos. Não apontar para os olhos ou face.

**DK** ADVARSEL! Anvend kun de medfølgende PLAYMOBIL-projektler. Sigt ikke mod øjne eller ansigt.

**NO** ADVARSEL! Benytt kun PLAYMOBIL-prosjektill som leveres med. Sikt ikke på ansikt eller øyne.

**SE FI** VARNING! Använd endast medleverade PLAYMOBIL-skott. Sikta inte mot ögon eller ansikte.

**FI** VAROITUS! Käytä vain mukana toimitettuja PLAYMOBIL-ammuksia. Ei saa kohdistaa suoraan silmiin tai kasvoihin.

**HU** FIGYELMEZTETÉS. Csak a csomagban található PLAYMOBIL lövedékeket szabad használni. Tilos szemre vagy arcra célolni.

**CZ** UPOZORNĚNÍ! Používejte pouze střely PLAYMOBIL, které jsou součástí dodávky. Nemířte na oči nebo na obličej!

**EE** HOIATUS! Kasutage ainult kaasaantud PLAYMOBIL'i laskemoona. Ära sihi silmadesse ega näkku.

**LV** BRĪDĪNĀJUMS! Izmantojiet tikai PLAYMOBIL piegādes komplektā iekļautos šāvņus. Nevērst pret acīm vai seju.

**LT** ĮSPĖJIMAS! Naudokite tik pridedamus PLAYMOBIL šaudmenis. Netaisyti į akis arba veidą.

**SI** OPOZORILO! Uporabljajte le priložene PLAYMOBIL-ove kroglice. Ne merite v oči ali obraz.

**SK** UPOZORNENIE! Používajte len náboje dodávané spolu so sadou PLAYMOBIL. Nemierť do očí alebo do tváre.

**PL** OSTRZEŻENIE! Stosować tylko załączone PLAYMOBIL - kule / pociski. Nie celować w oczy i twarz.

**TR** CY DİKKATI! Sadece birliktle verilen PLAYMOBIL mermileri kullanınız. Göze veya yüze doğru tutmayınız.

**GR** CY Προειδοποίηση! Να χρησιμοποιούνται αποκλειστικά τα βλήματα της PLAYMOBIL που περιέχονται στη συσκευασία. Μη μπηγεται στοχαστη στα μάτια ή στο πρόσωπο.

**RO** AVERTISMENT! Se folosesc doar proiectilele incluse PLAYMOBIL. Nu se țintește în ochi sau în față.

**BG** Внимание! Използвайте само приложени PLAYMOBIL снаряди. Не насочвайте към очите и лицето.

**HR** UPOZORENJE! Upotrijebiti samo od strane PLAYMOBIL-a isporučene projektile. Ne ciljati u oči ili lice.

**CN** 警告! 仅能用PLAYMOBIL的炮弹, 请勿瞄准眼睛或脸. (说明书上含有重要信息, 请保留备用)

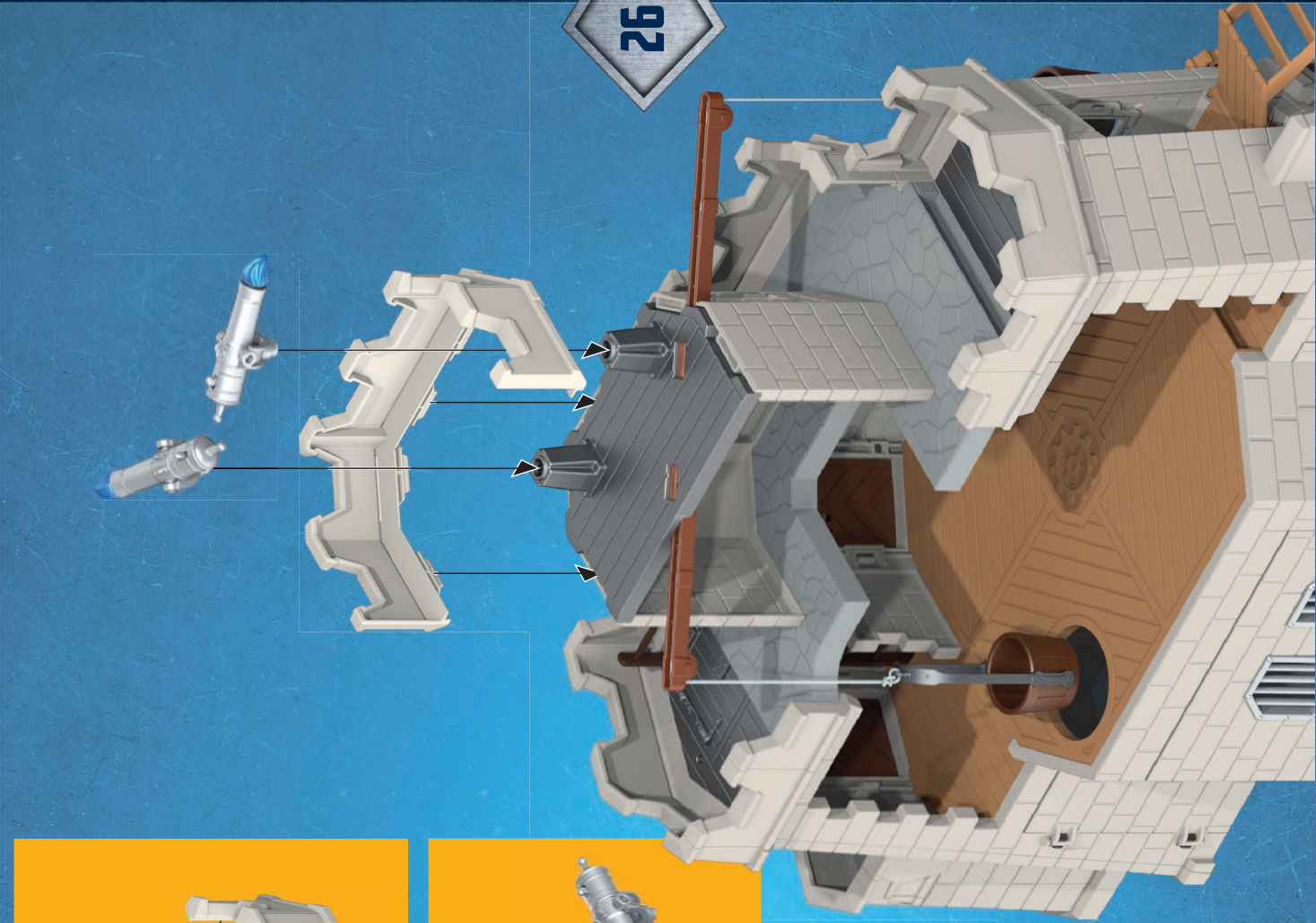
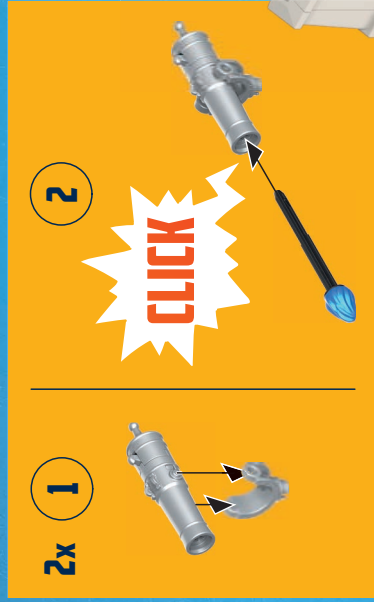
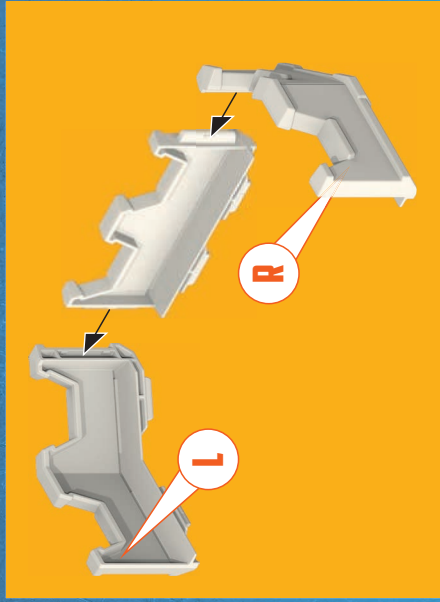



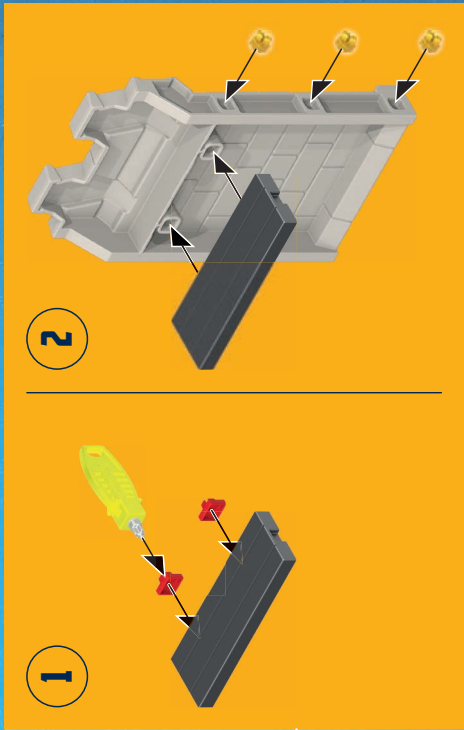
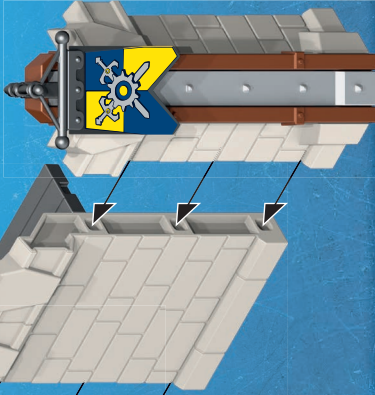

1

2



1

1

2

3

4

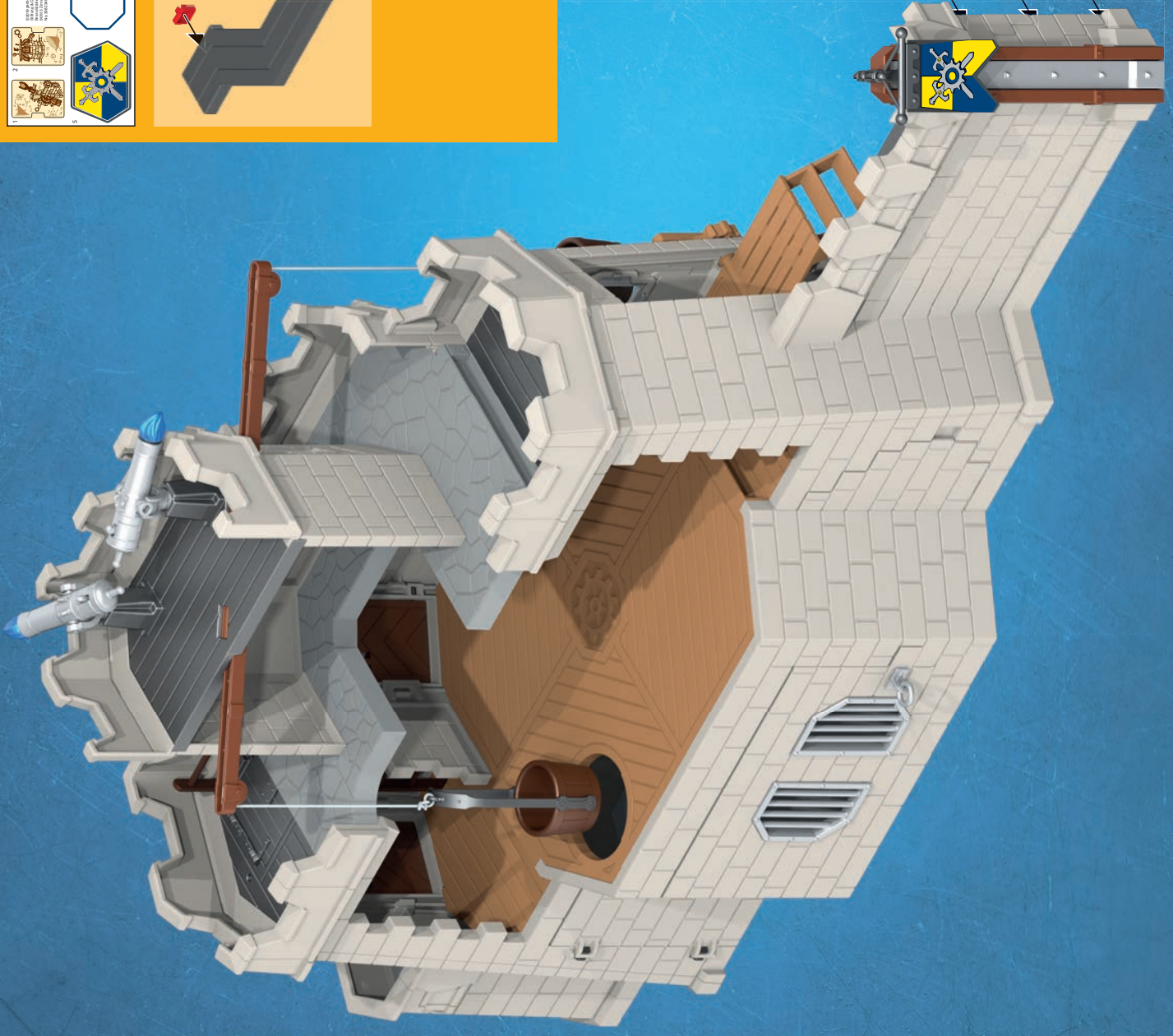
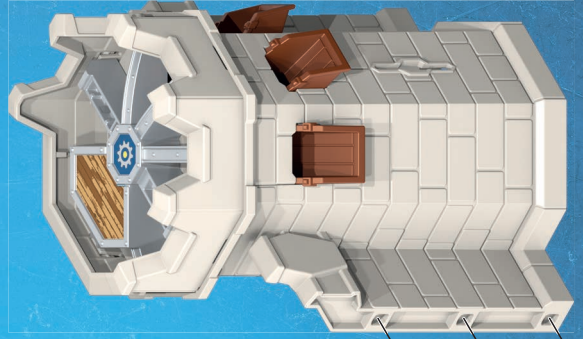
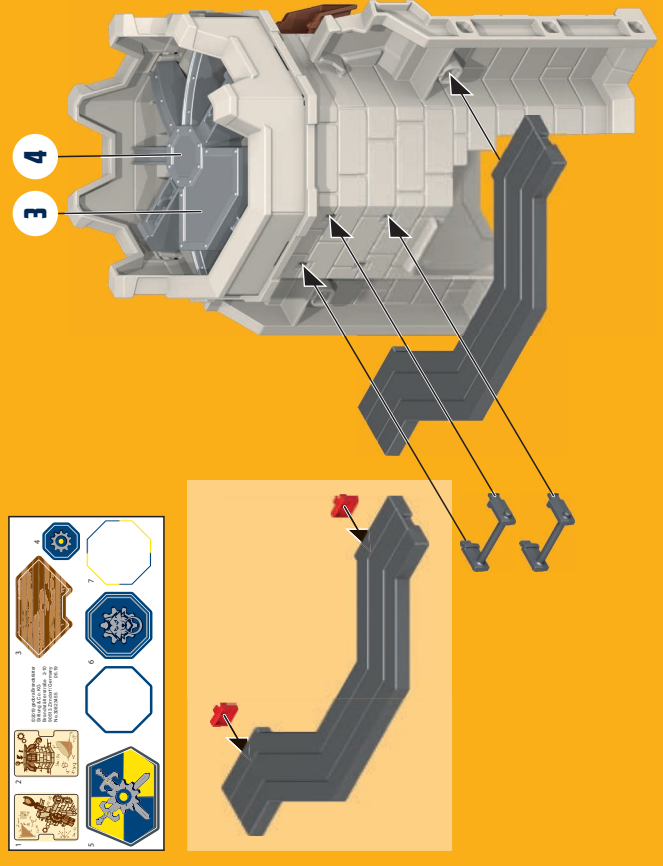

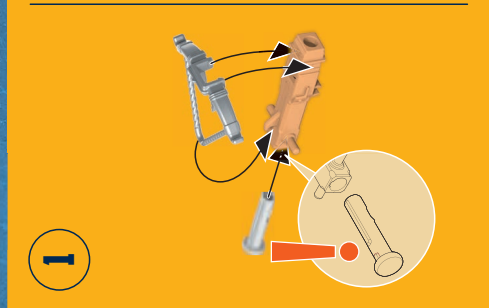
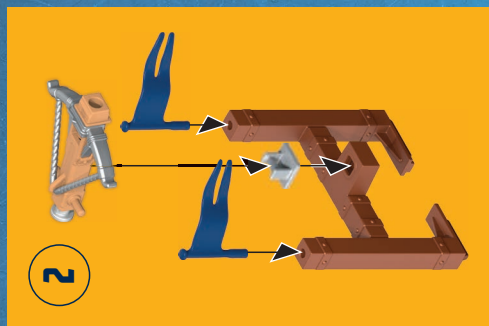
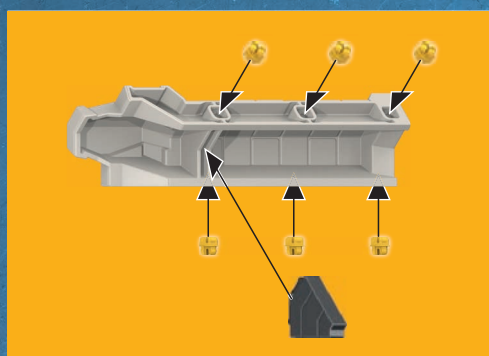

2

1

31

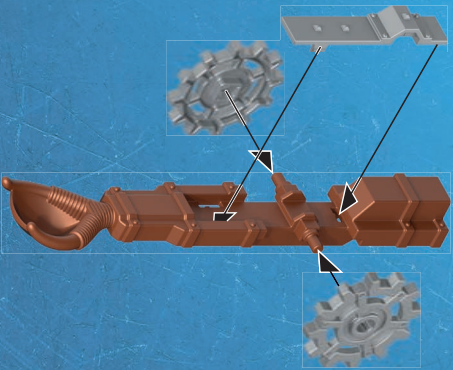

30

33

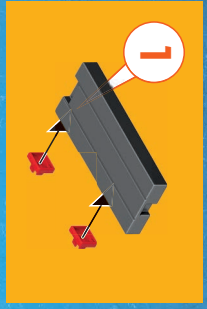
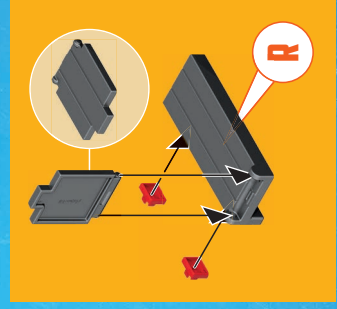
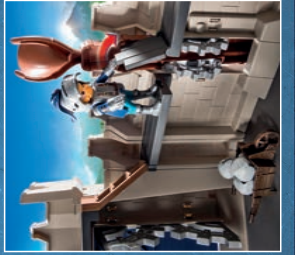
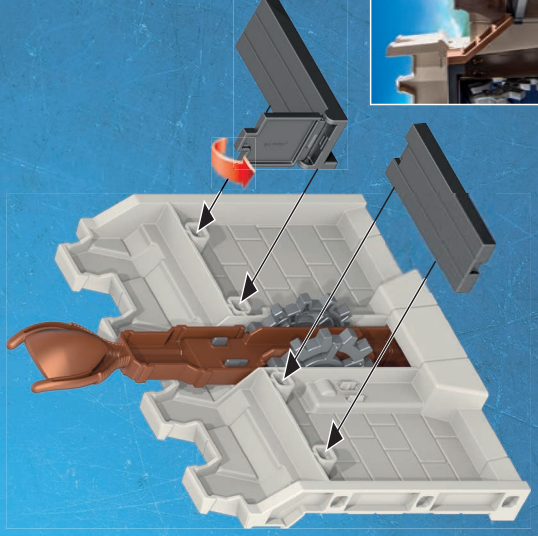

32

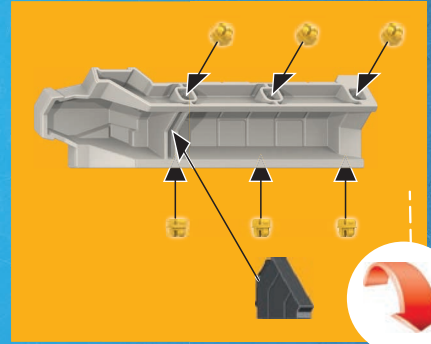

36

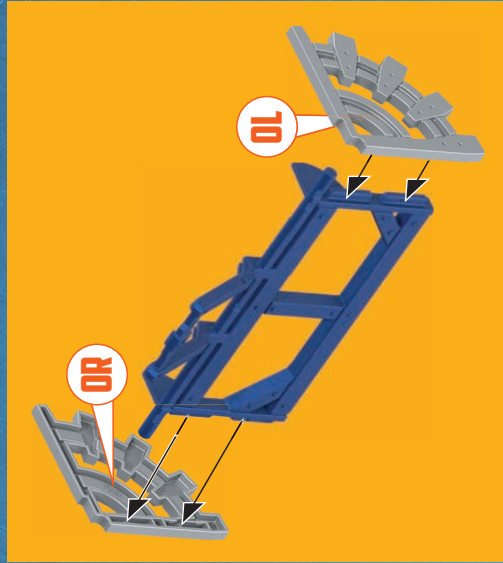

35

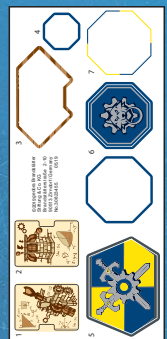
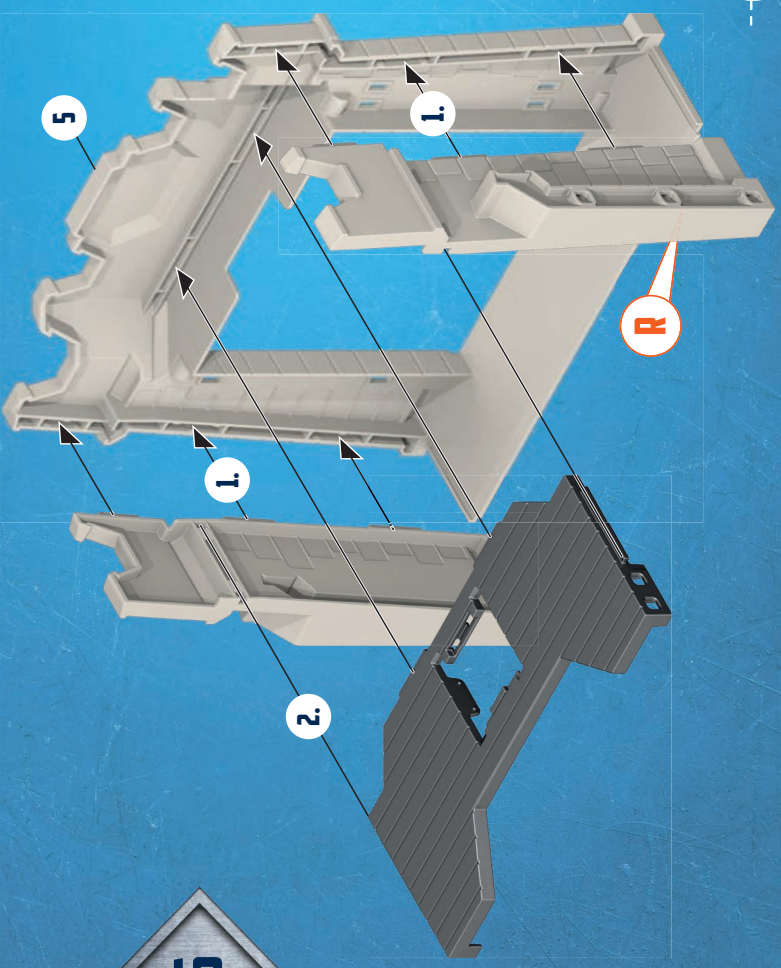

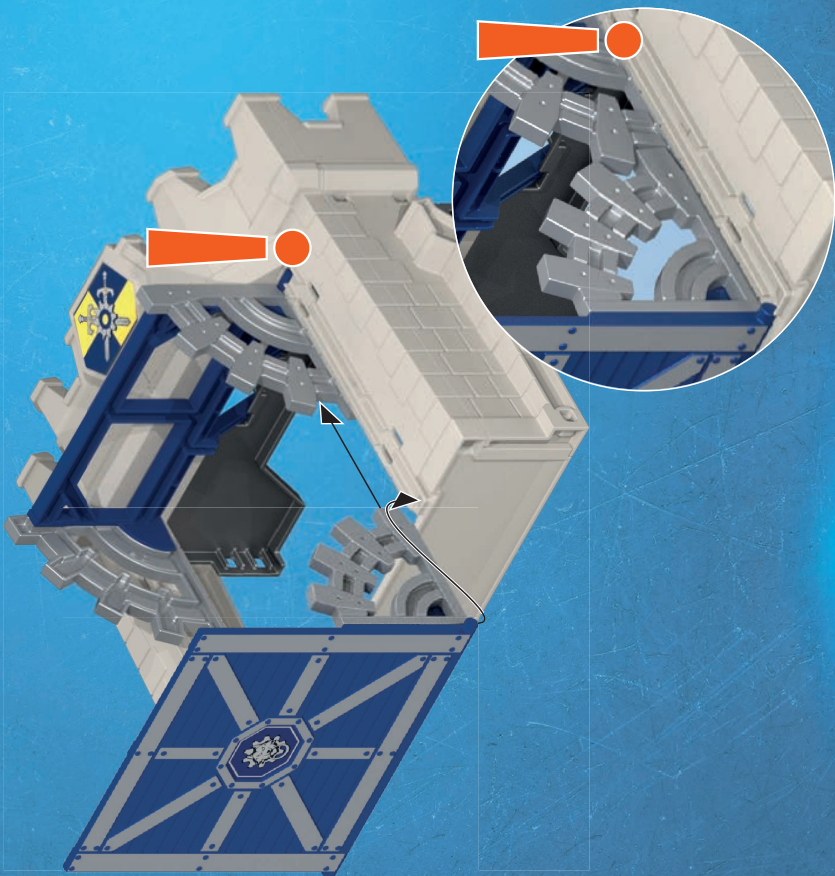
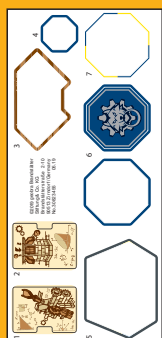
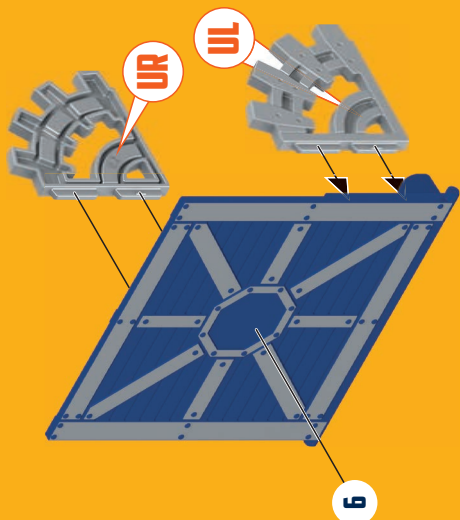
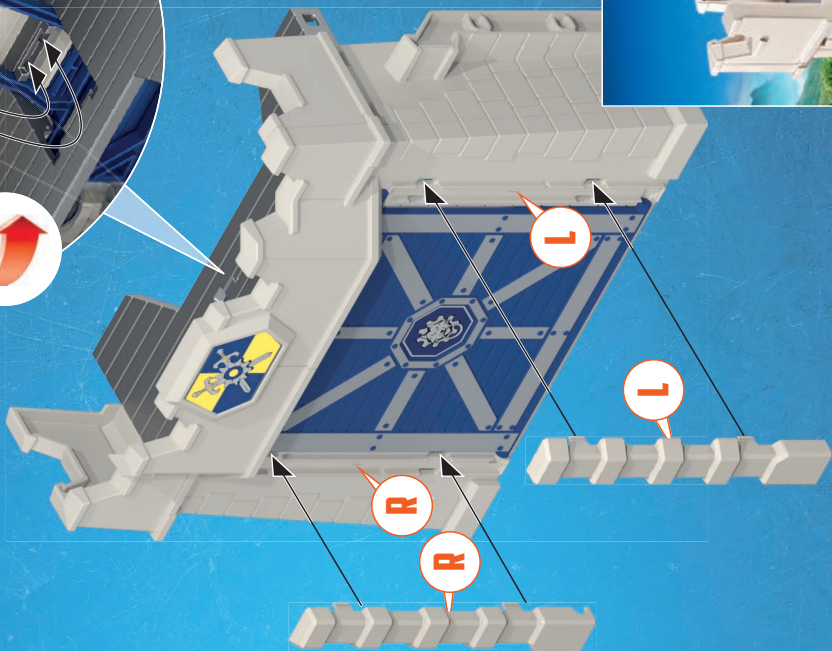
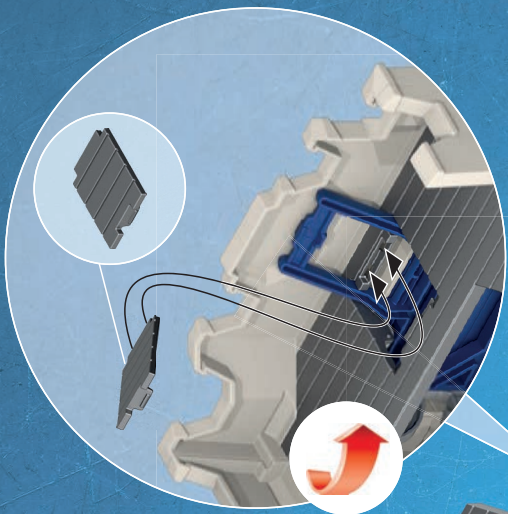

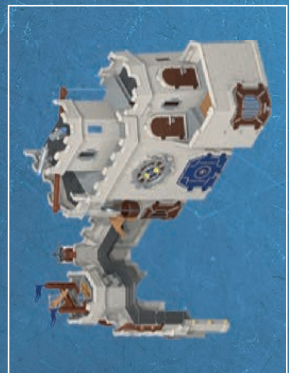
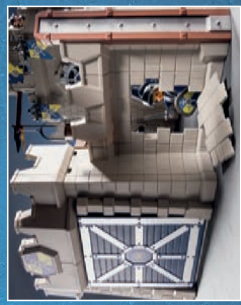

**1**

**2**



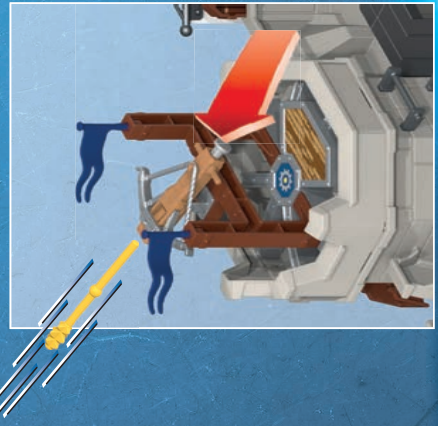
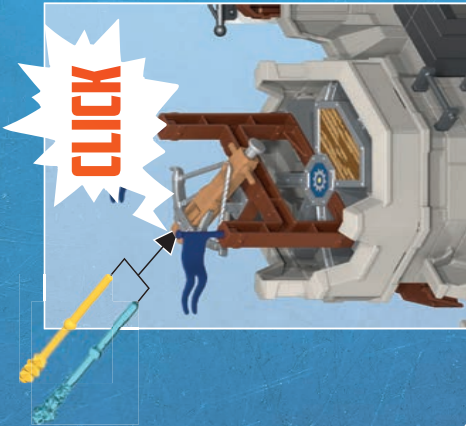
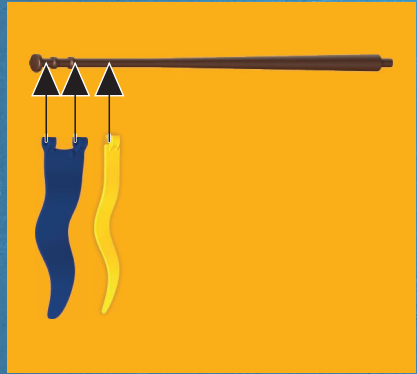
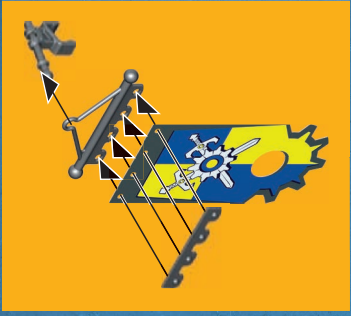

42



44

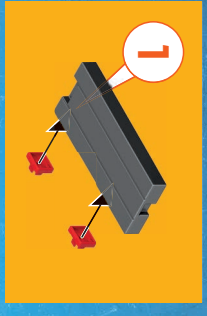
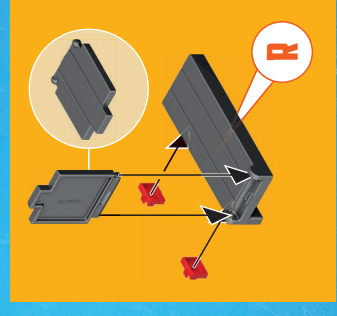
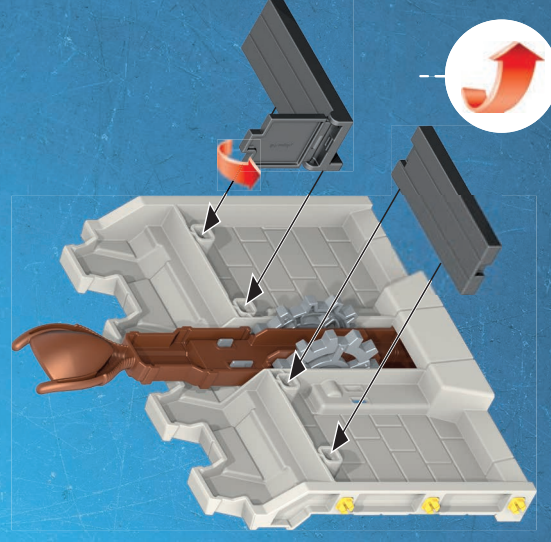

41

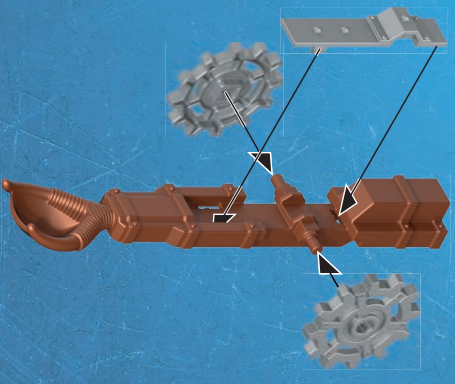

43

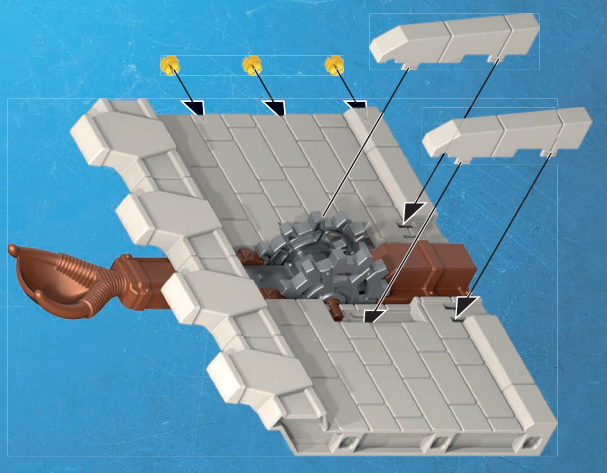

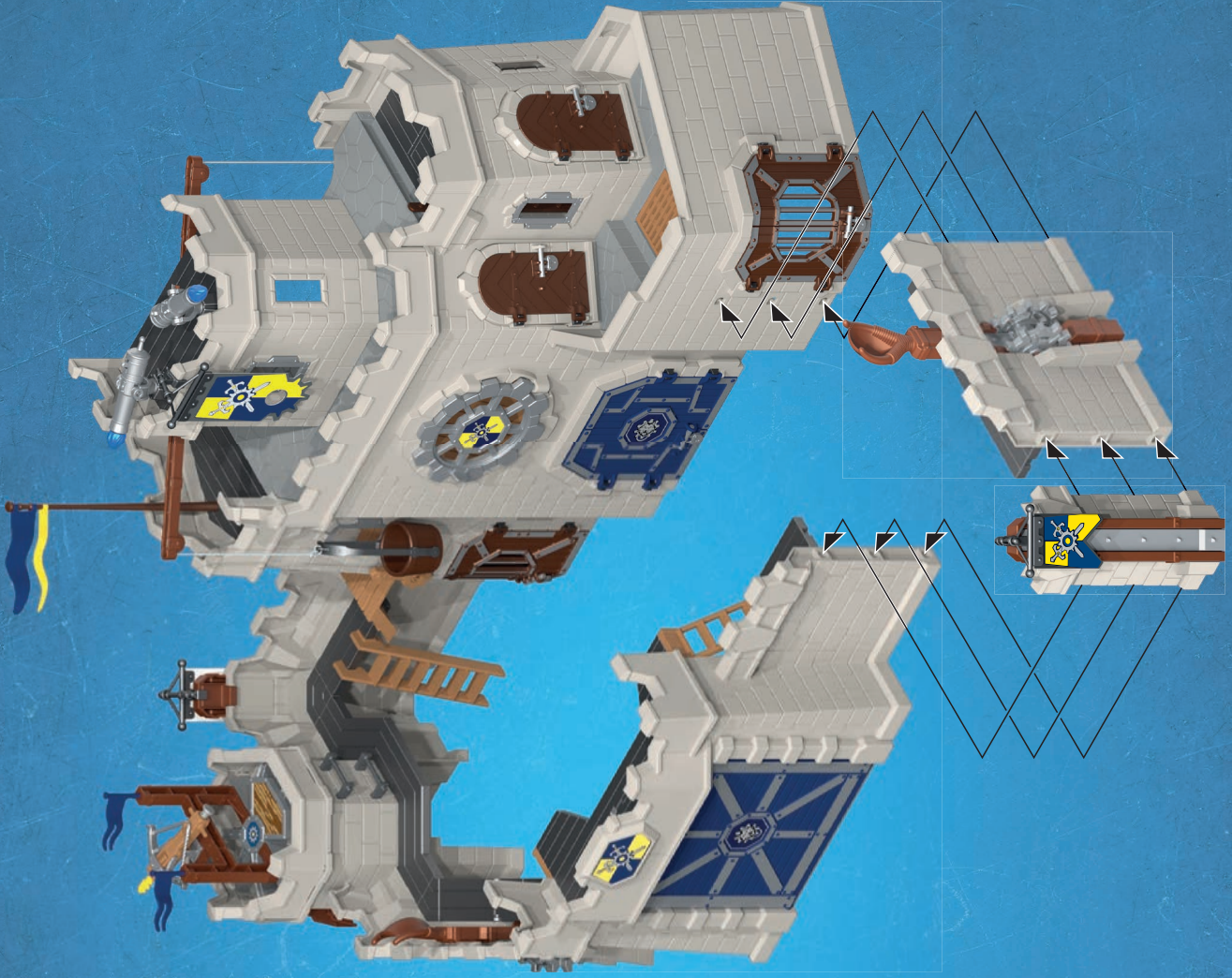

2

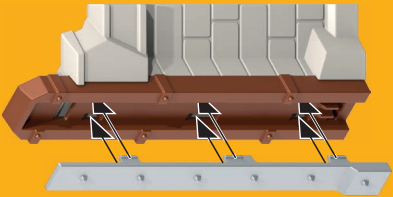

4

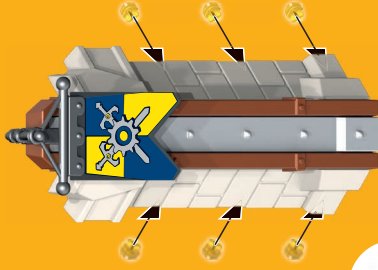

1

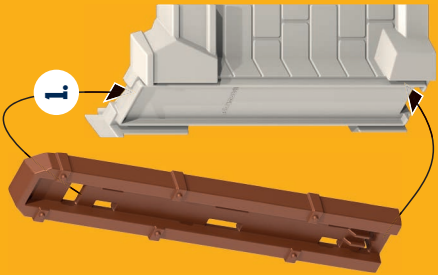

3

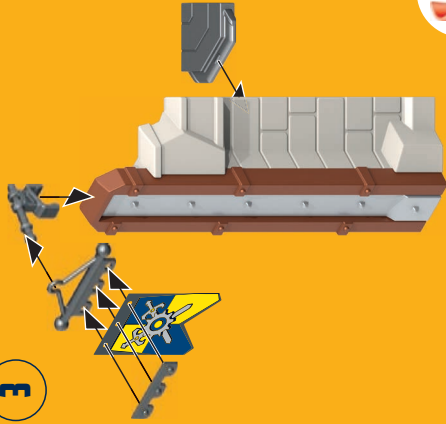

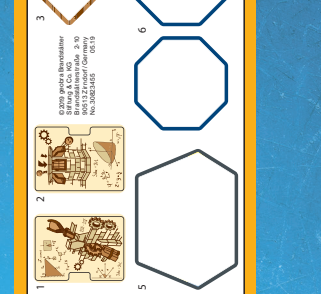
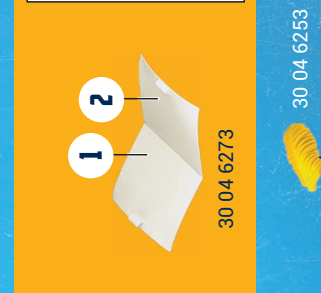
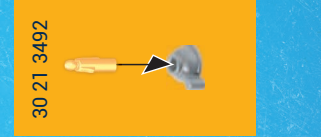
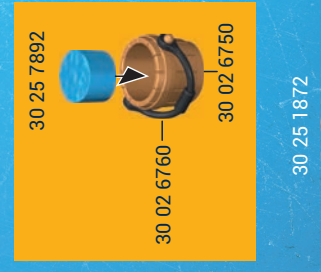
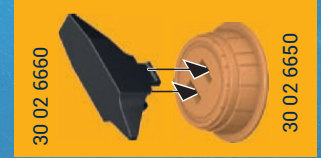
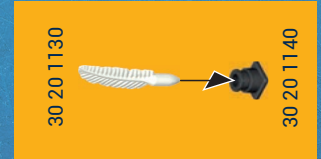
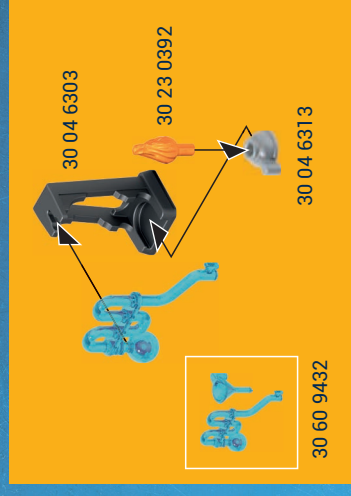
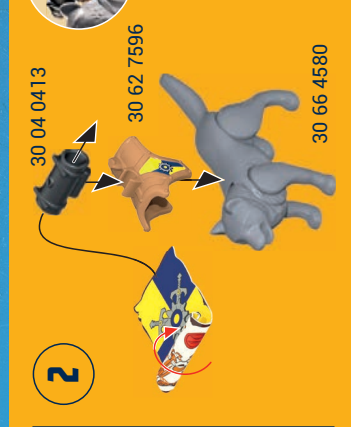
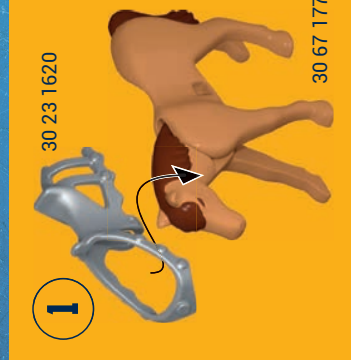
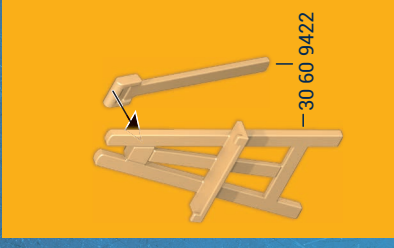
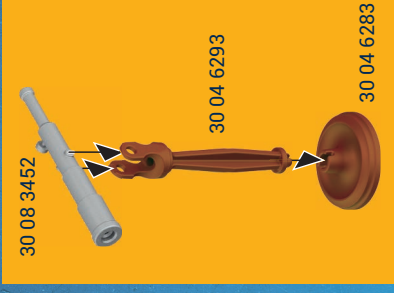
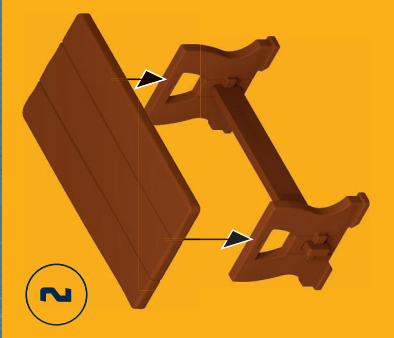
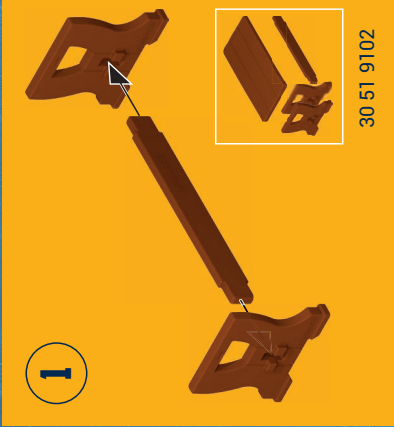
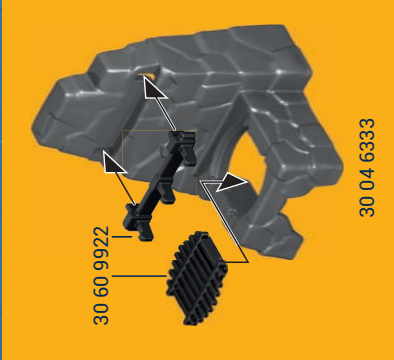

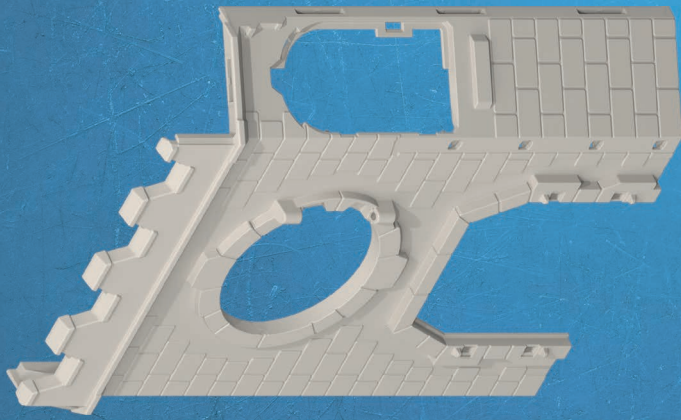

30 04 6693

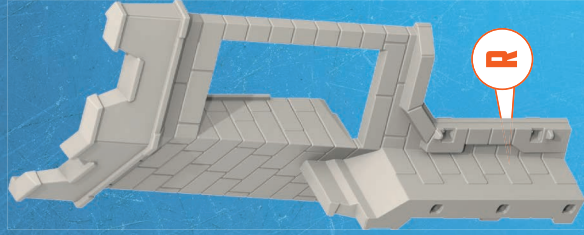

30 04 6623

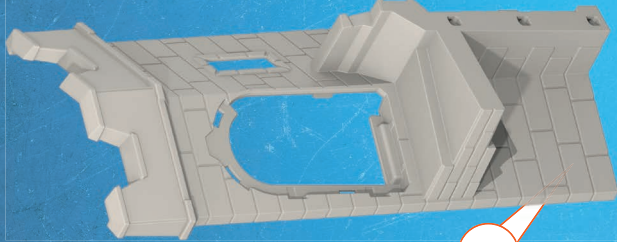

30 04 6633

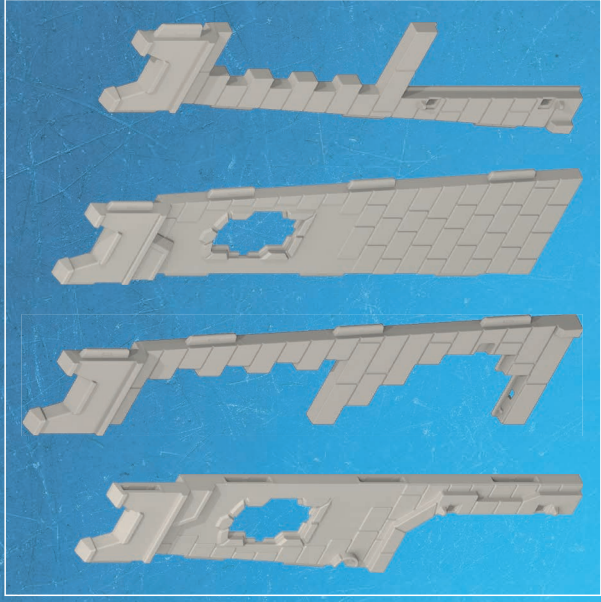

30 51 9162



30 65 2604

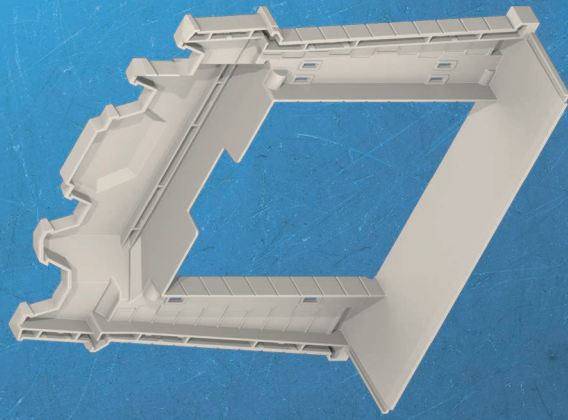

30 04 6343

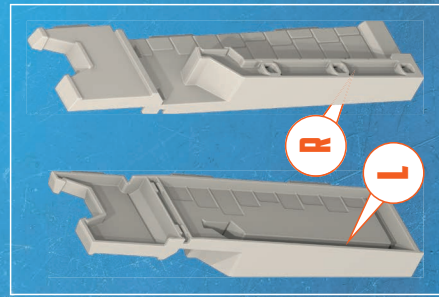

30 51 9112

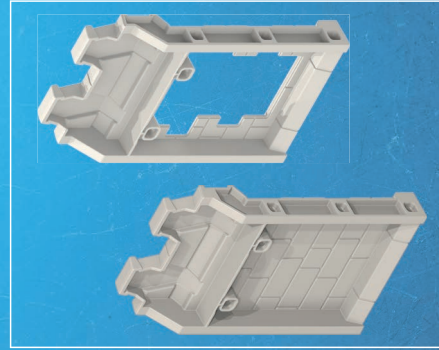

30 51 9152

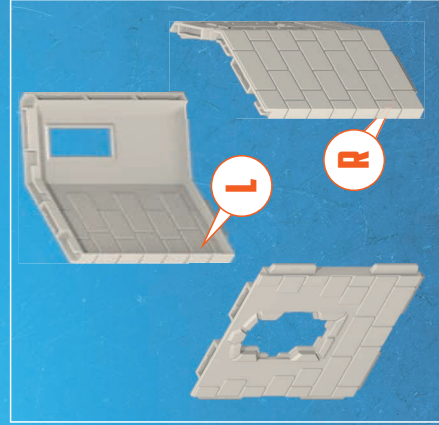

30 51 9222

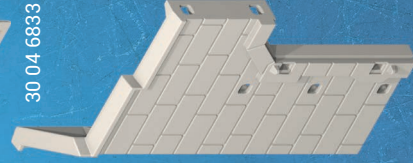

30 46 5592



30 04 6833



30 04 6673



4x 30 04 6463

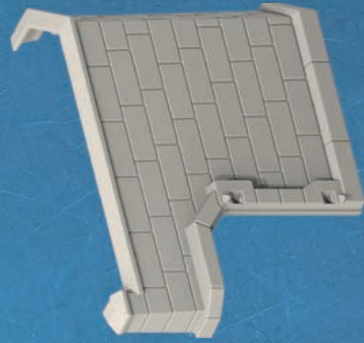

30 46 5902



30 04 6753

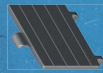

30 04 6793



30 04 6823

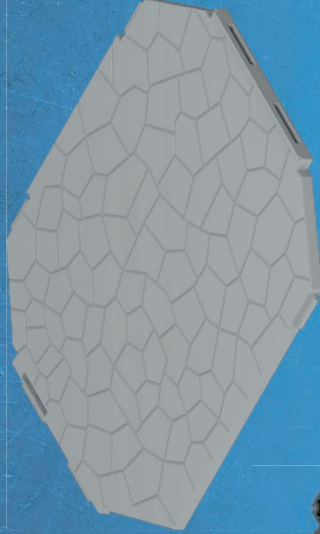

30 04 6683

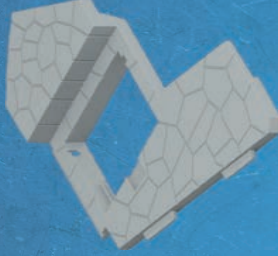

30 04 6813

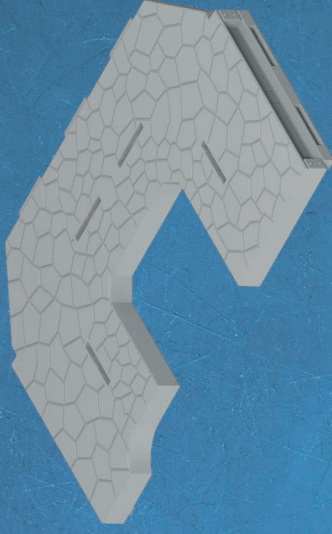

30 04 6763

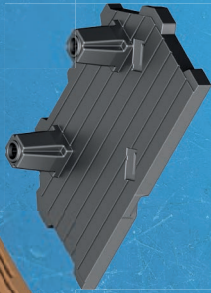

30 04 6783



2x 30 04 6403

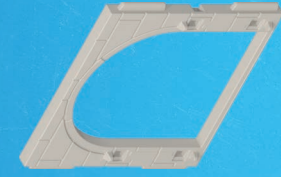

30 04 6733

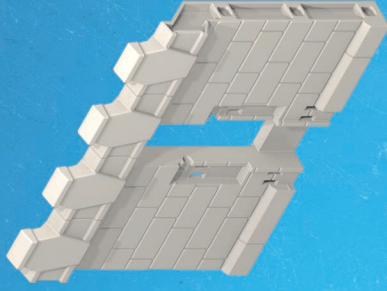

2x 30 04 6423

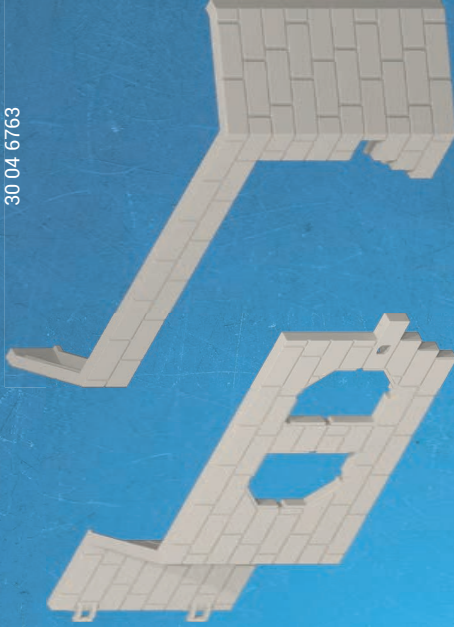

30 46 5912

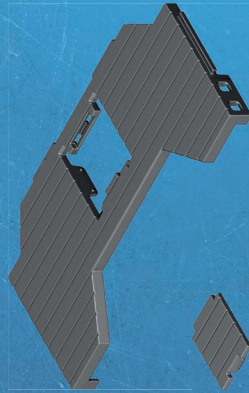

30 04 6363

30 04 6353

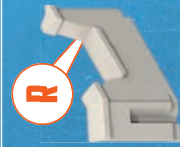

R



L

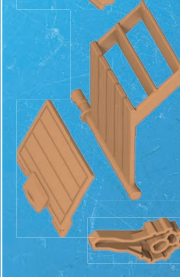
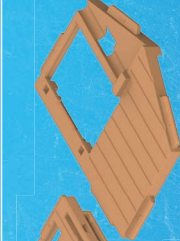

30 51 9212

30 51 9182

30 51 9192

30 51 9172

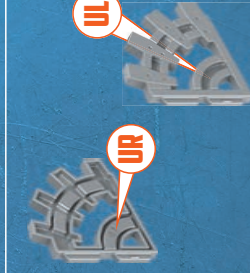

UR



OR

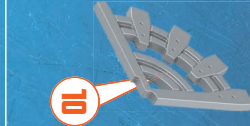

OL

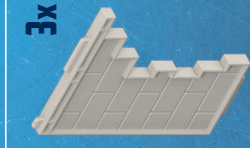

3x

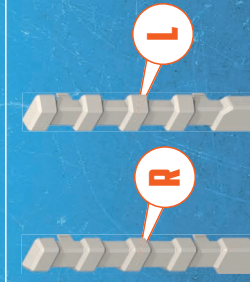

R

L

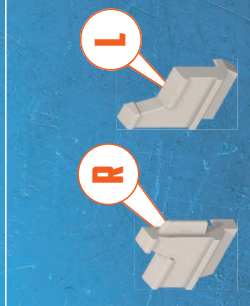

R

L



L

R

30 51 9122

30 51 9342

30 51 9132

30 51 9202

30 51 9232

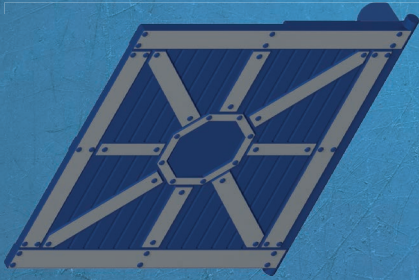

30 62 9736



30 04 6383



30 62 9766

R

L



30 62 9776

R

L



2x 30 62 9746



2x 30 62 9756

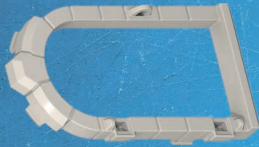

2x 30 04 6713



2x 30 27 2200



2x 30 04 6743



30 04 6703



30 04 6563

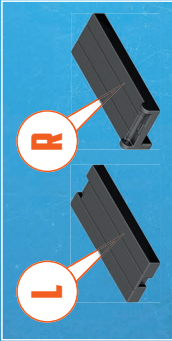

R

L

2x 30 51 9302



2x 30 04 6613



2x 30 04 6473



2x 30 04 6603



2x 30 04 6413

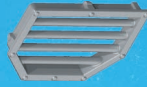

2x 30 04 6803



3x 30 04 6643



2x 30 07 6830

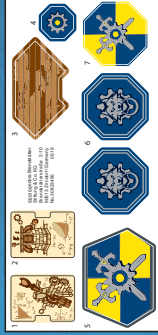

30 82 3455



2x 30 04 6433



2x 30 04 6583



2x 30 04 6593



30 21 9630



30 29 2960

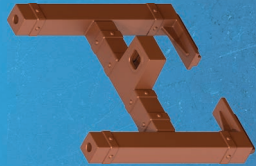

30 04 6523

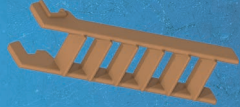

30 04 6843



2x 30 04 6393



4x 30 04 6443



2x 30 04 6453



2x 30 07 6840



30 04 6773

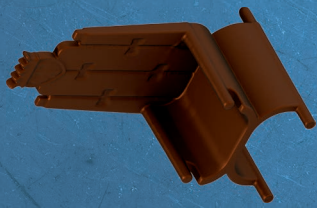

30 02 2250



30 65 2514

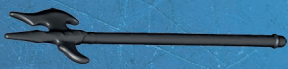

30 21 8382



30 82 3415



2x 30 82 3425



30 04 6183



30 24 7480



30 04 6153



30 65 8822



30 62 7586



30 62 9656

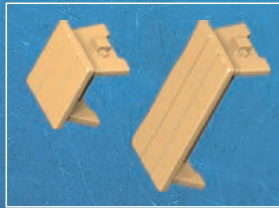

30 61 3290



30 04 6323



2x 30 65 6332



2x 30 22 7122



3x 30 04 6863



2x 30 80 2692



30 24 8240



30 89 7122



30 62 9716



30 62 9726



30 04 6543



30 04 2263



2x 30 03 1953



2x 30 04 6873



2x 30 29 5610



6x 30 07 7830



30 71 9872

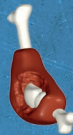

30 21 7213



2x 30 22 8890



30 21 8520



30 60 9442



30 05 8570



30 21 2580



30 24 8483



30 24 8473

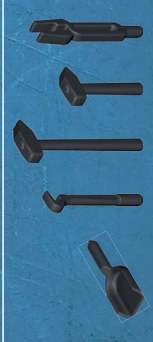

30 51 0512



2x 30 51 3832



30 60 9472



30 27 9030



6x 30 24 7680



30 28 2500



30 21 4263



24x 30 07 7040

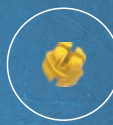

48x 30 03 6600



16x 30 09 6900



**70220 + 9839**

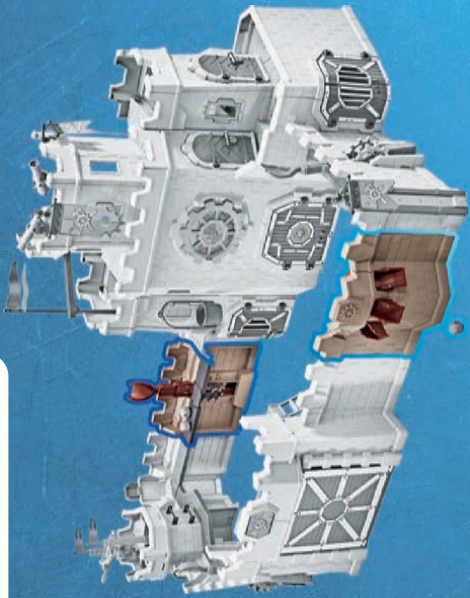

**9839**



**70220 + 9840**

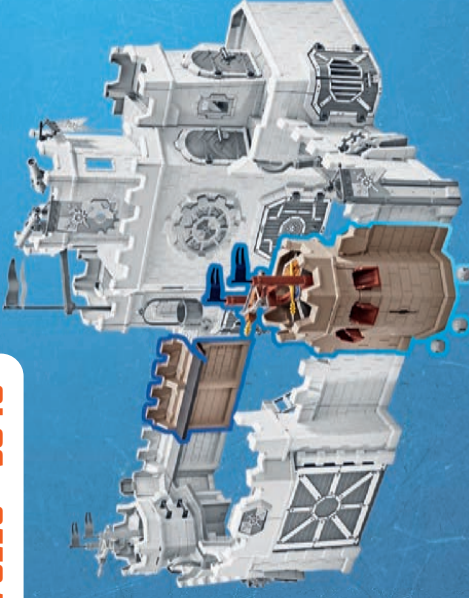

**9840**



**70220 + 70221**



**70220**



**70221**

Serviceadressen finden Sie in allen PLAYMOBIL-Prospekten

Addresses of Customer Service Departments are shown in all PLAYMOBIL catalogues

L'adresse du service consommateurs est indiquée dans tous les catalogues PLAYMOBIL

Troverete gli indirizzi dei centri di assistenza in tutti i cataloghi PLAYMOBIL

UK-Distributor:  
Playmobil UK Ltd.

Regency House  
1 Miles Gray Road

Basildon  
Essex

SS14 3RW  
UK

**UK  
CA**

In alle PLAYMOBIL catalogi vindt u het adres van onze klantendienst.

Las Direcciones de los Departamentos de Servicio al Consumidor se encuentran en todos los catálogos PLAYMOBIL

Η διεύθυνση του Υπηρεσίου Εξυπηρέτησης Καταναλωτών PLAYMOBIL βρίσκεται σε όλους τους καταλόγους PLAYMOBIL.

pronounced: play-mó-beel

1

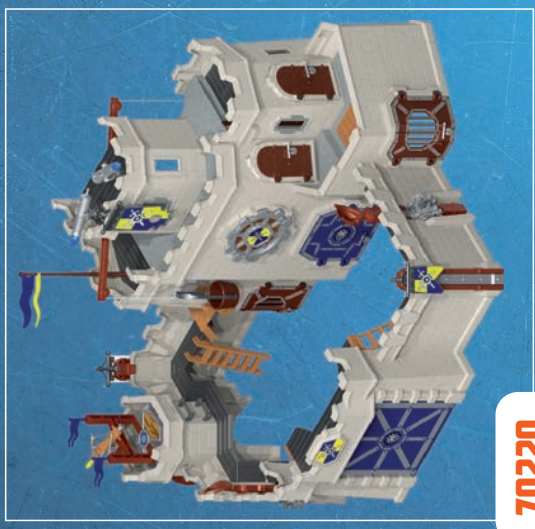
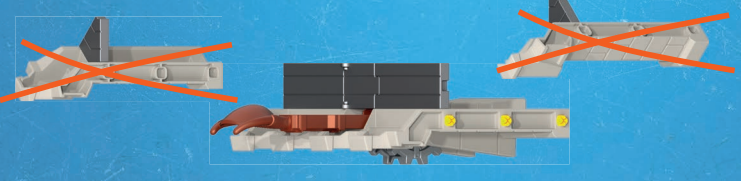
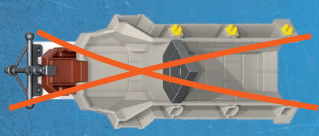
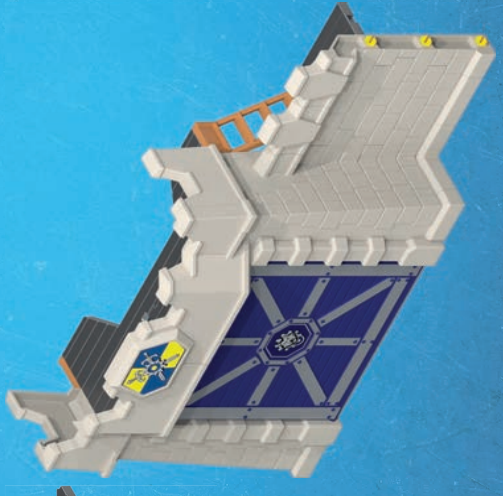

70220

70220 + 70221

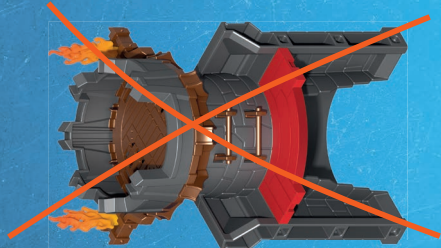
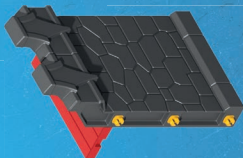

70221

3

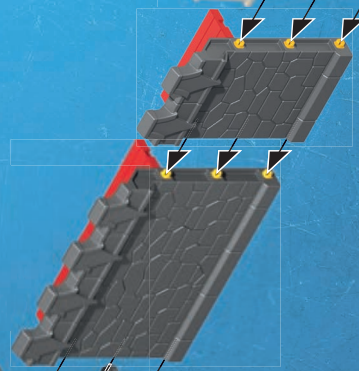
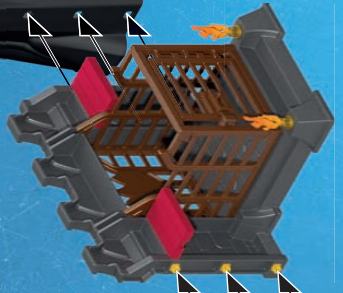
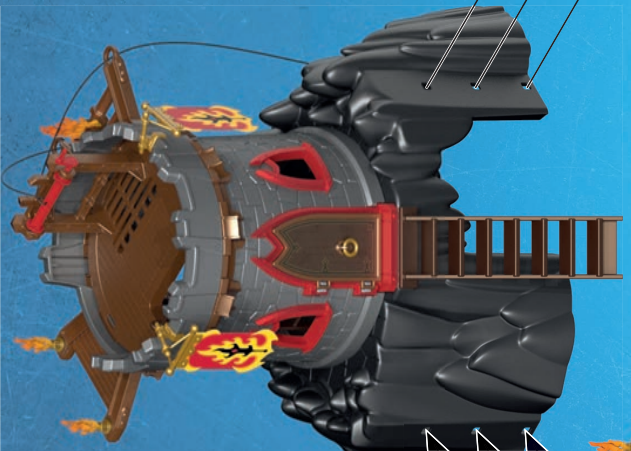
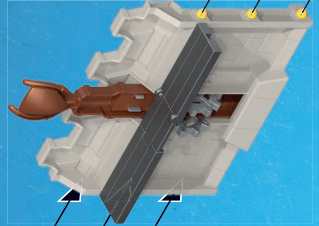
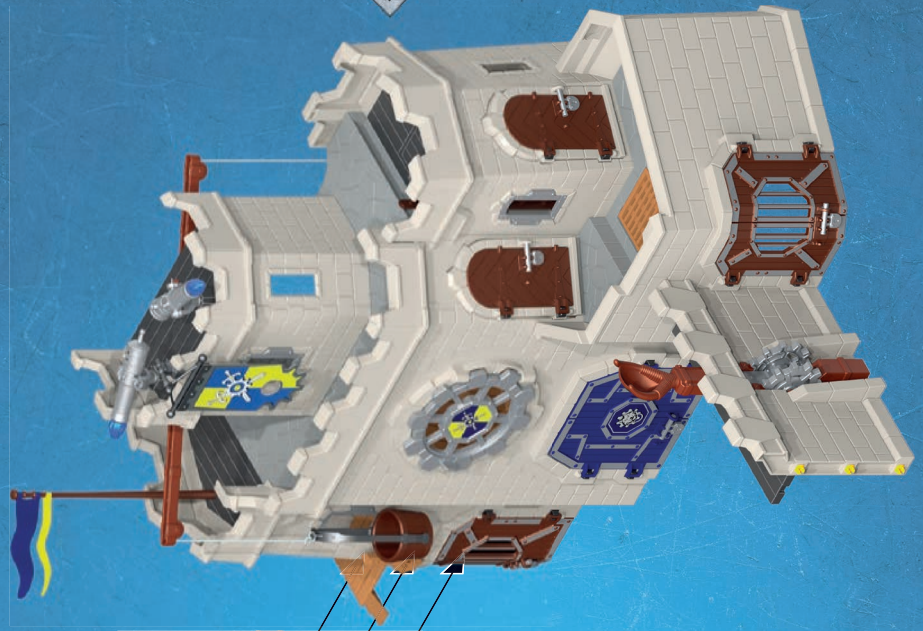

4



# NOVELMORE



70224



70225

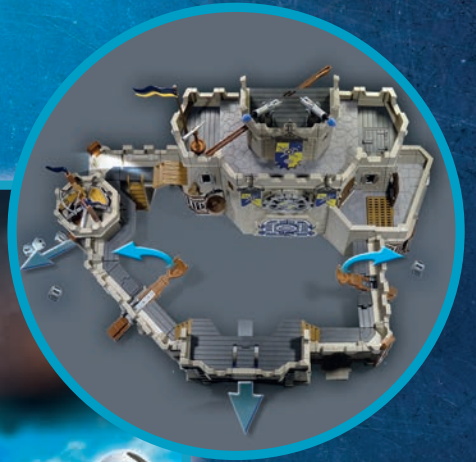

~~70220~~

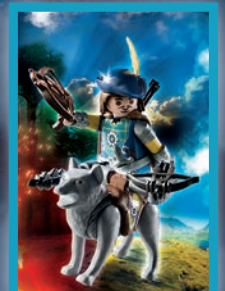

70229



70223



70228



70227



70226



70221

playmobil®



©2019 geobra Brandstätter Stiftung & Co. KG  
Brandstätterstr. 2-10 • 90513 Zirndorf, Germany  
No. 3081 3055 06.22

