

playmobil®

70132

Wichtige Unterlagen, bitte sorgfältig aufbewahren!
Important: Please keep these instructions for future reference!
Documents importants, à conserver soigneusement!
Belangrijke documenten, bewaar deze zorgvuldig!



WARNING:
CHOKING HAZARD

Small parts. Not for children under 3 years.

”Ne concerne que les USA“



1

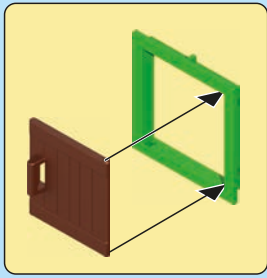
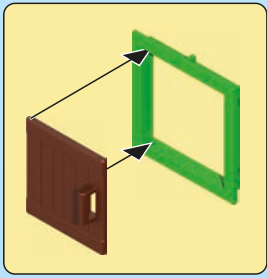

2

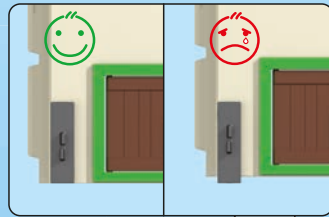
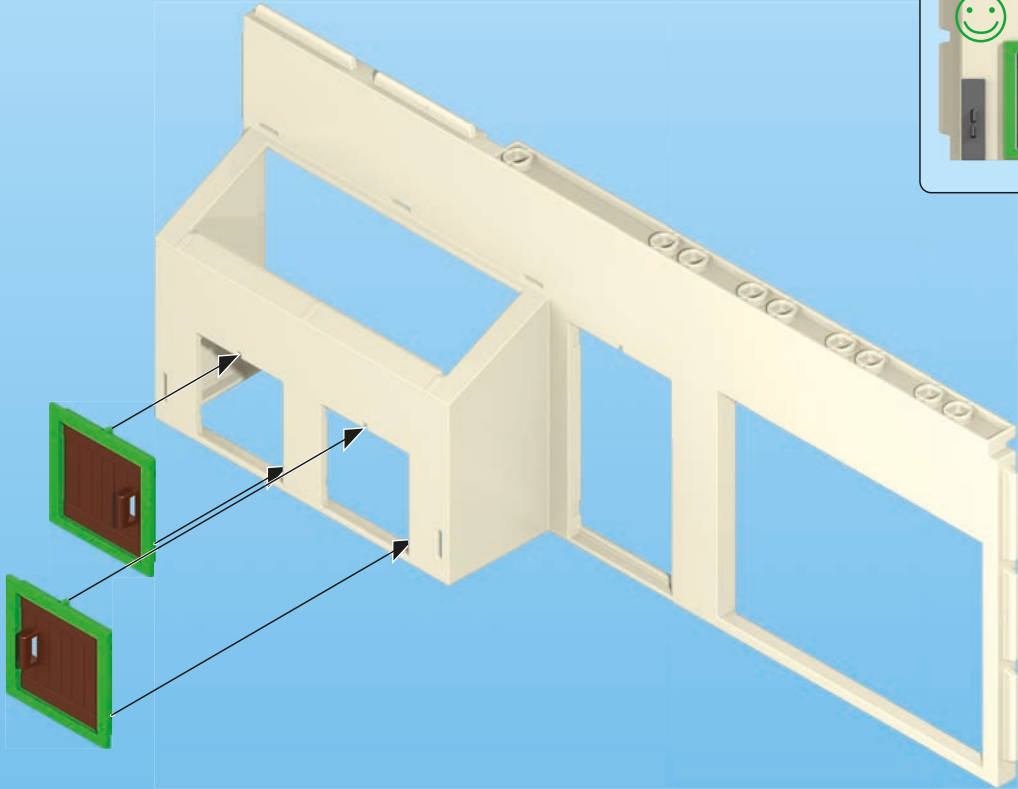
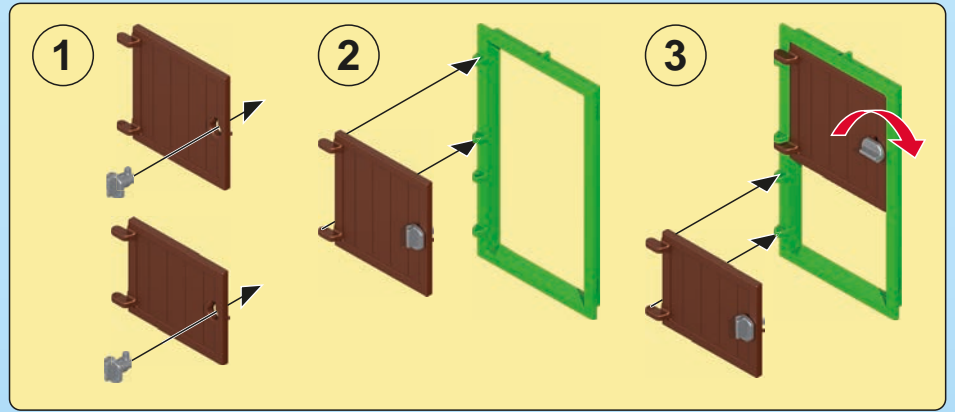

!

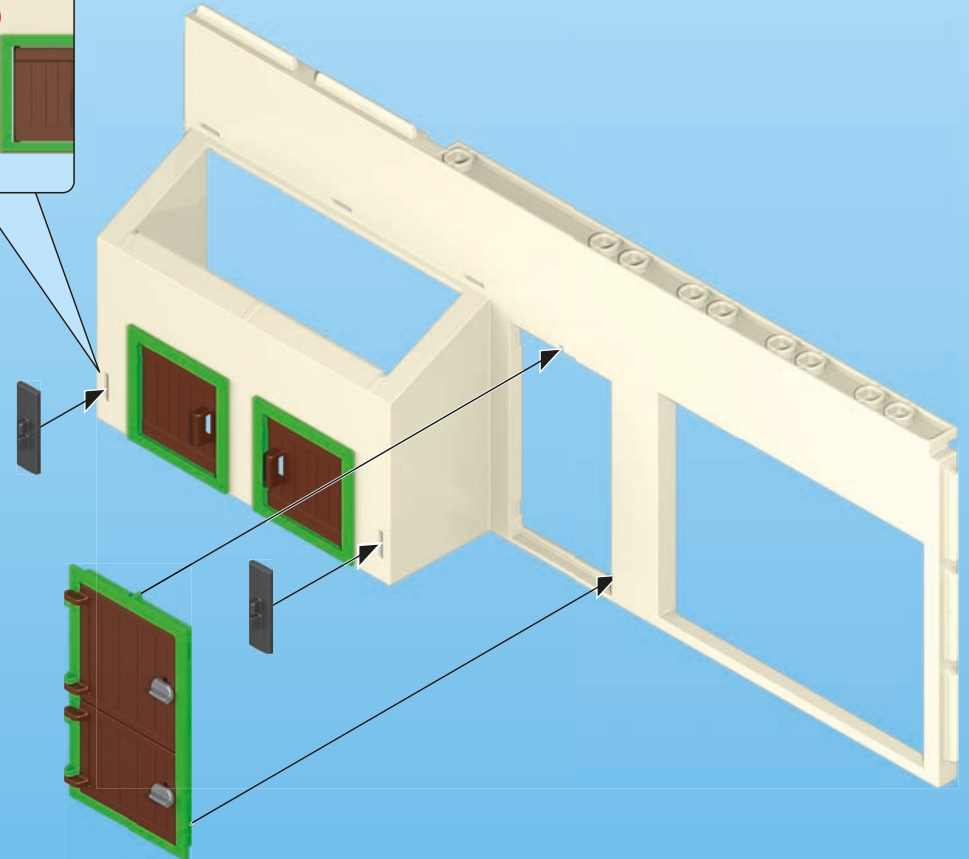

3

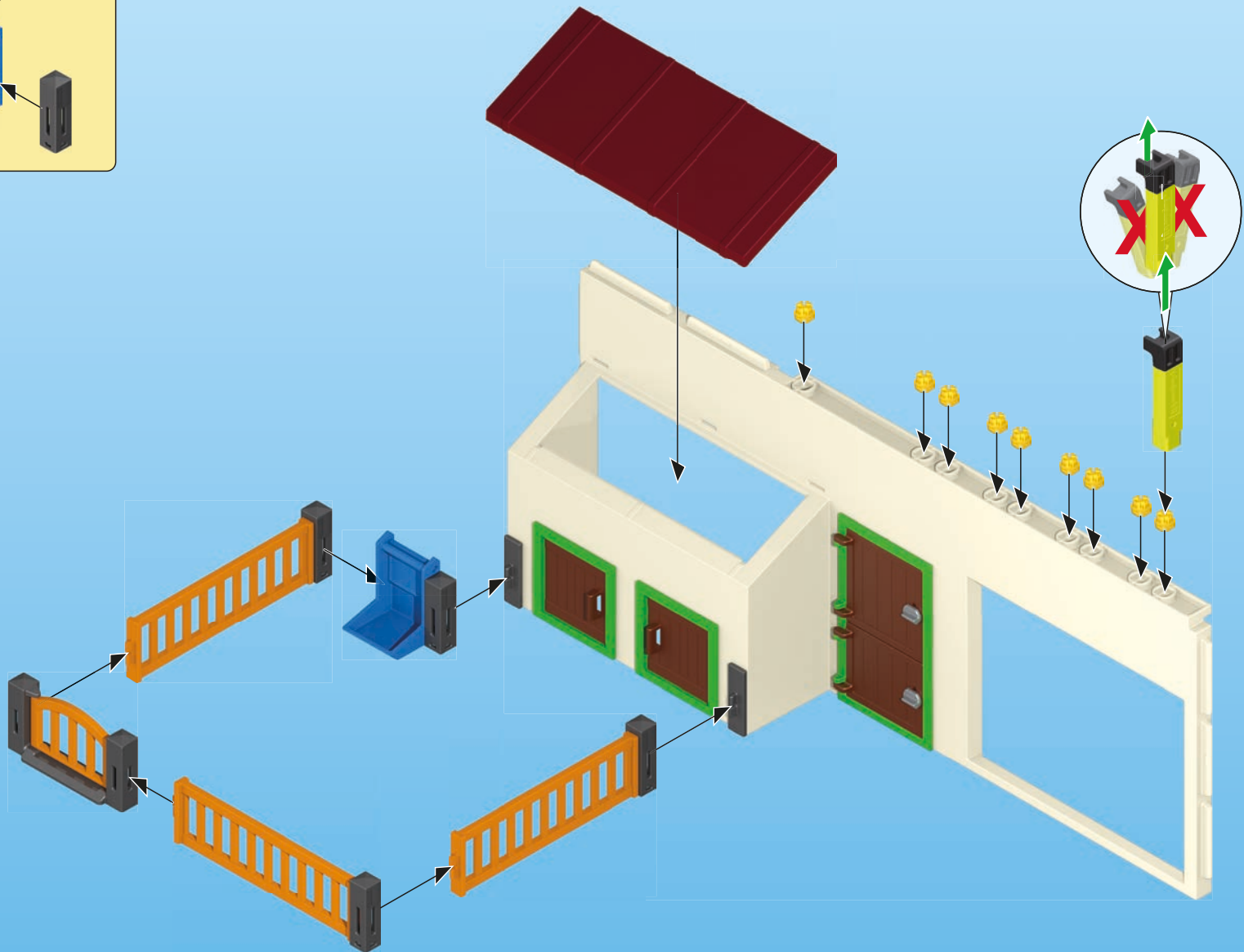
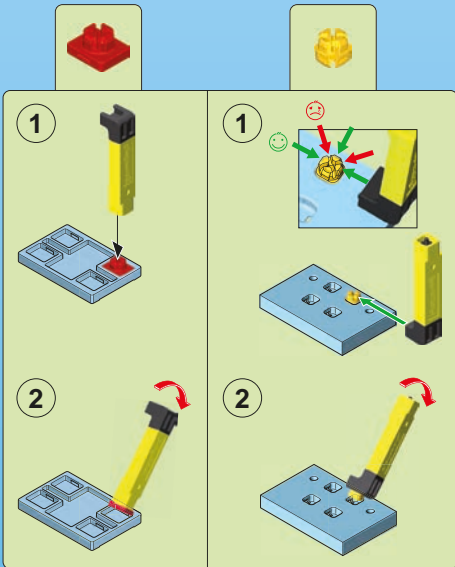
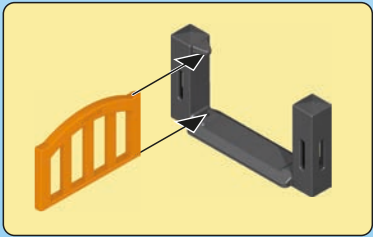
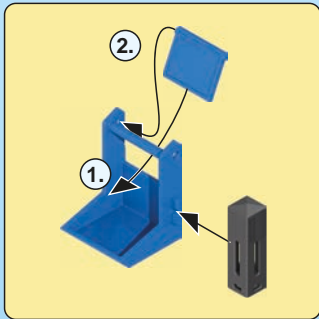
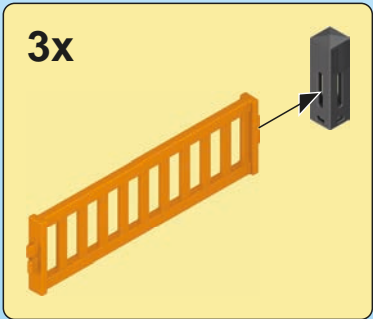

1

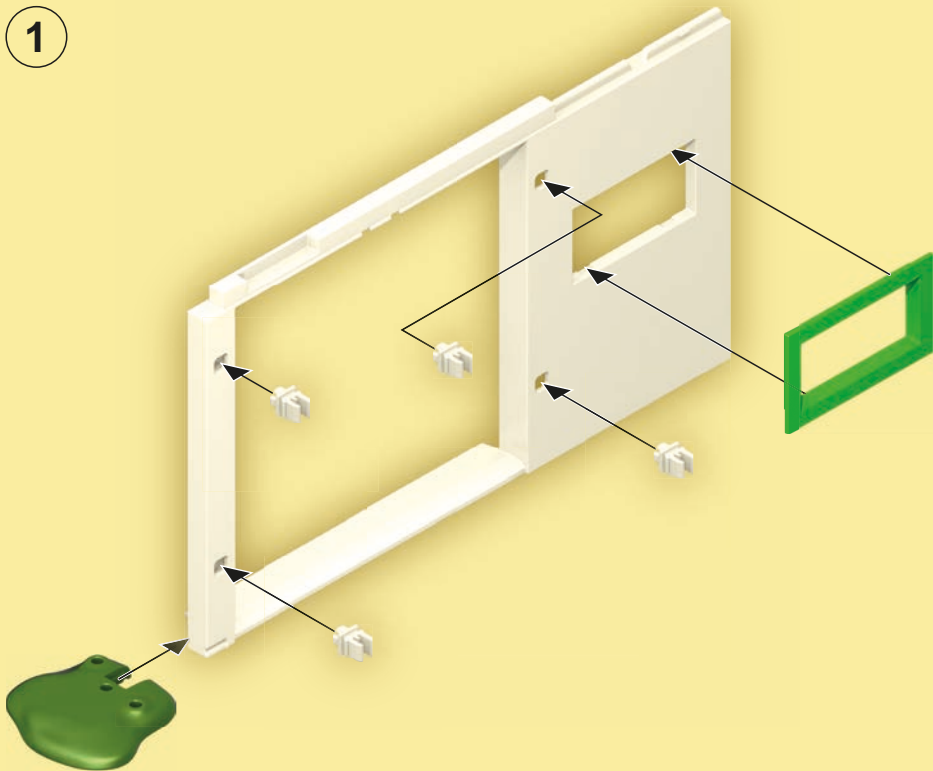

2

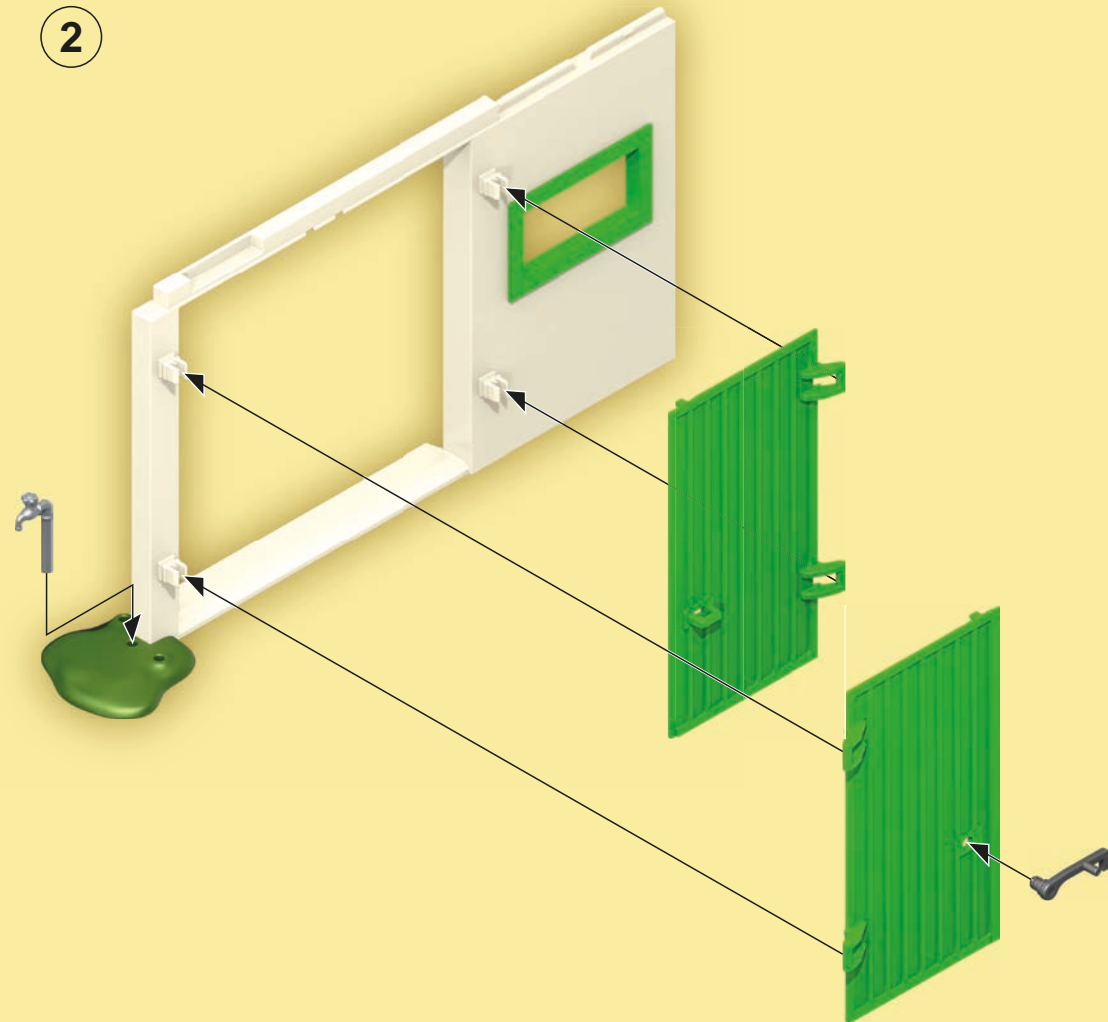

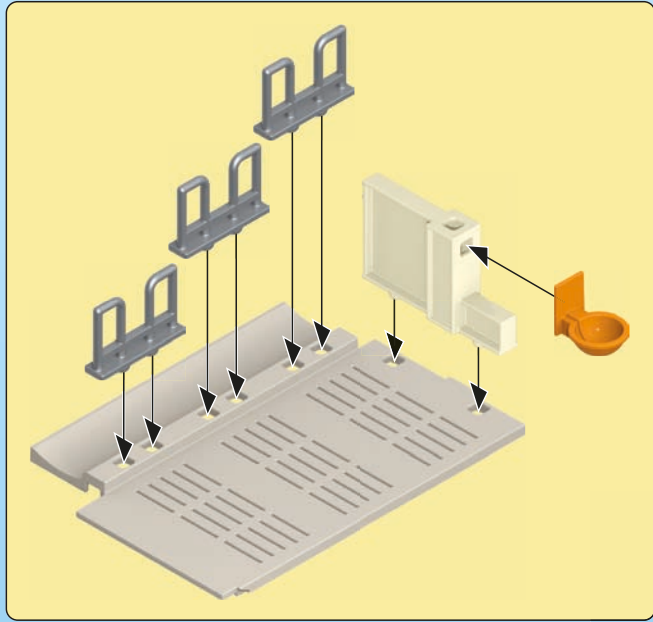

4

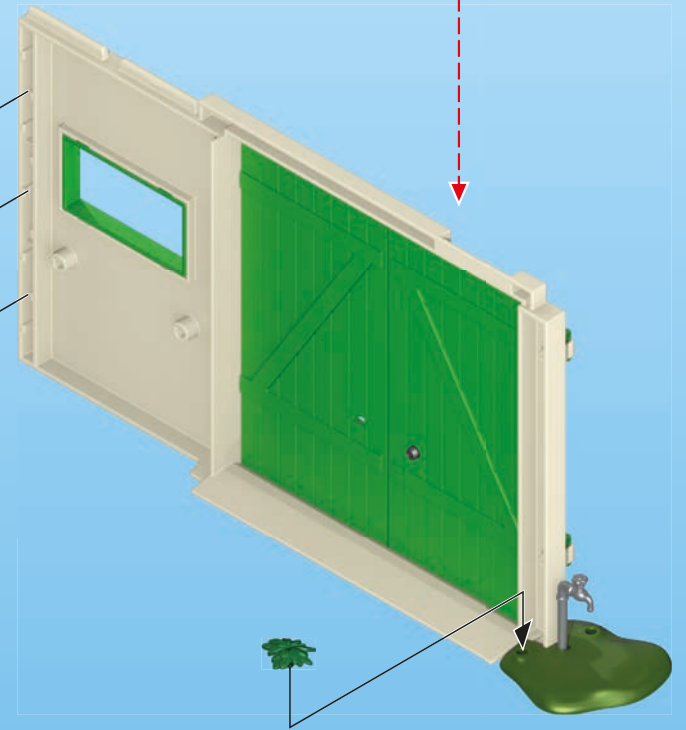
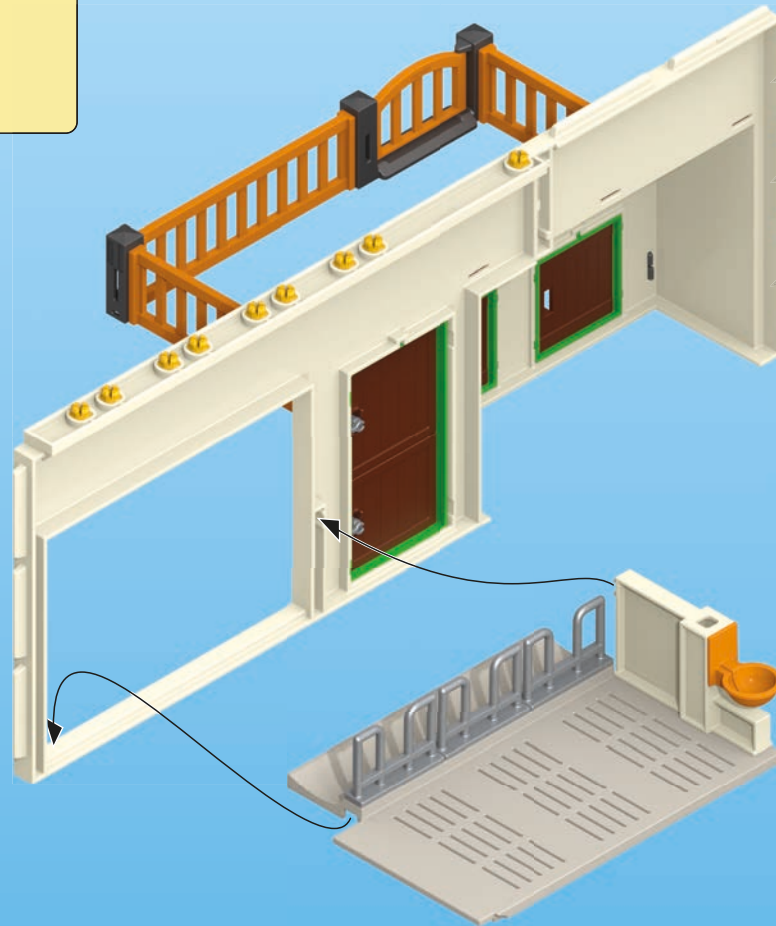

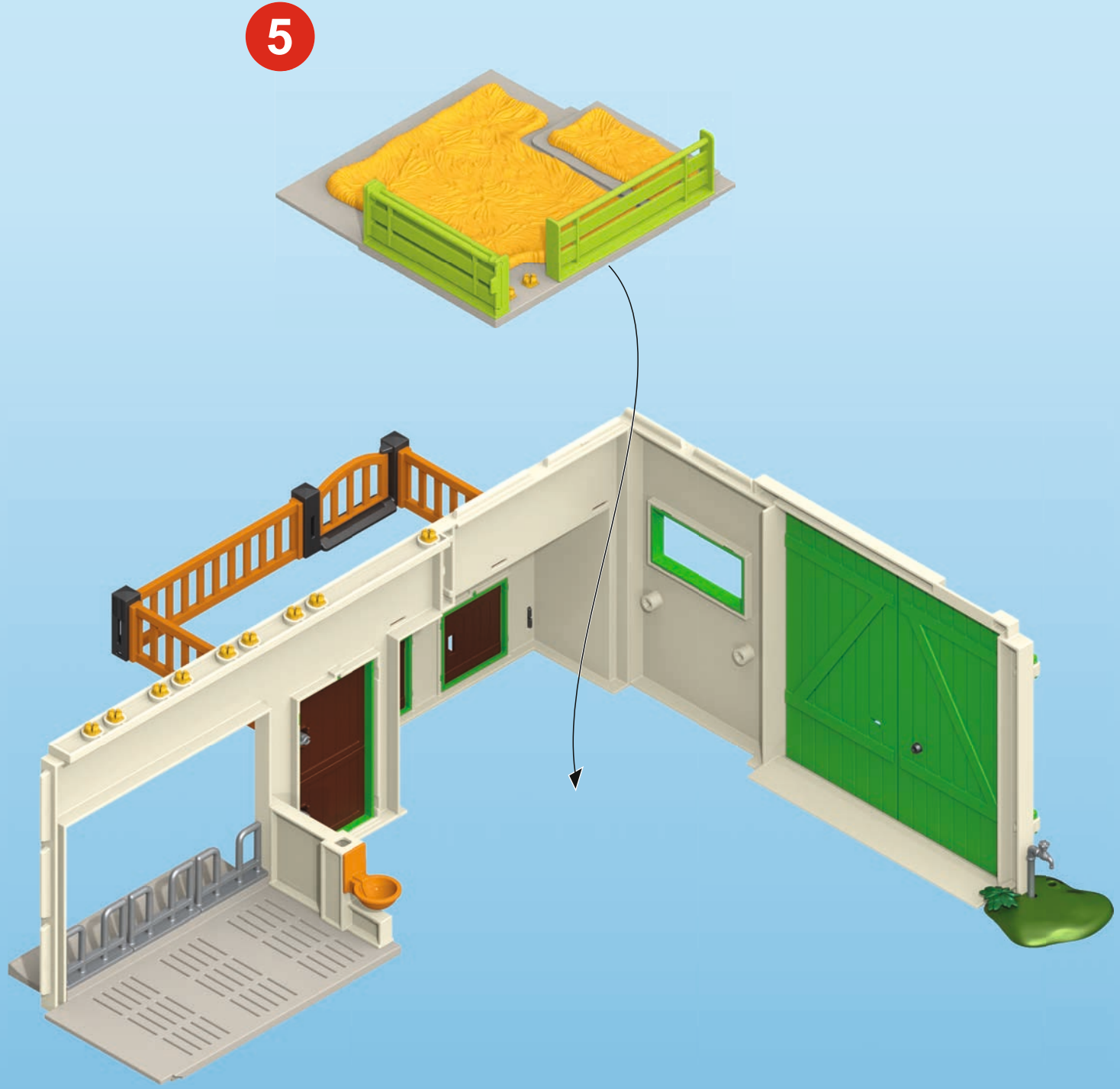
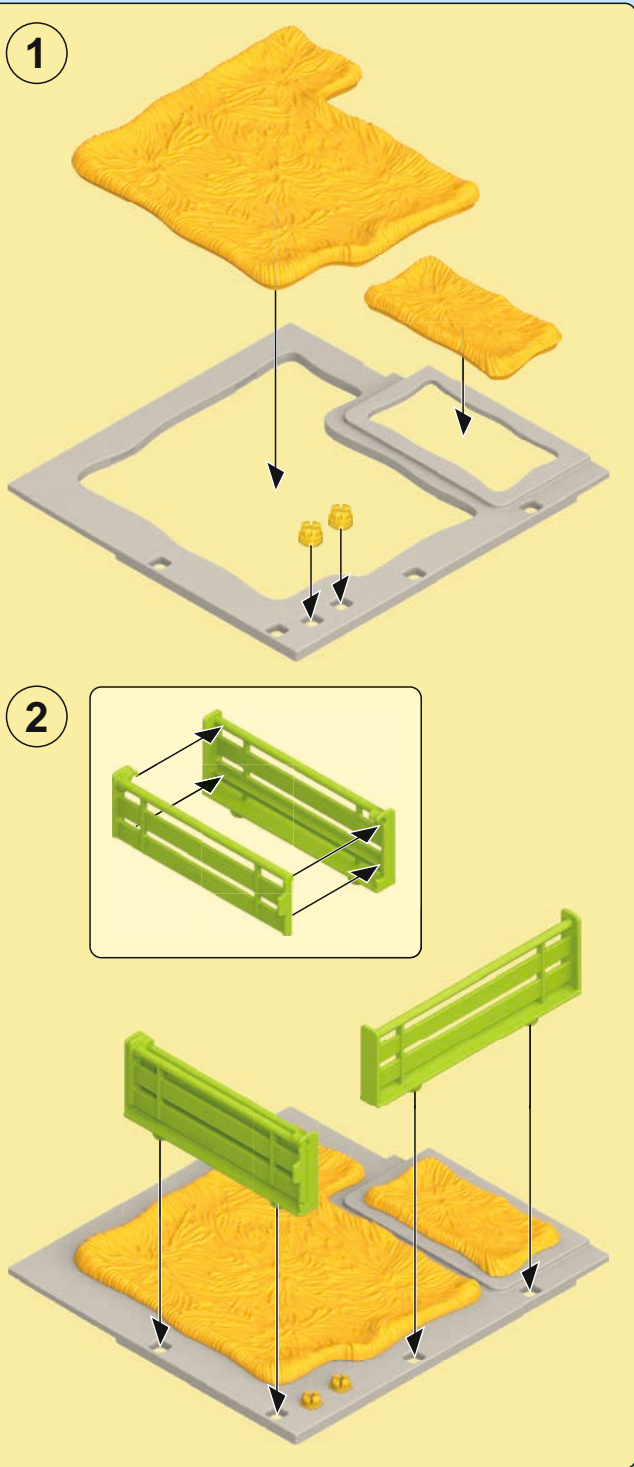

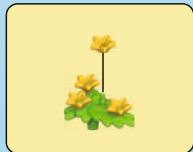
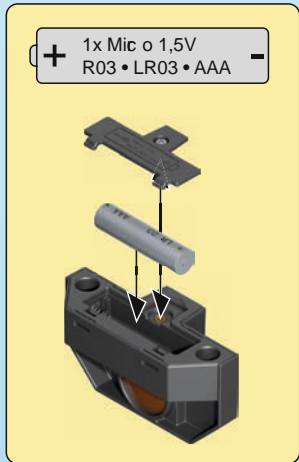

6



An / Aus
On / Off
Marche / Arrêt

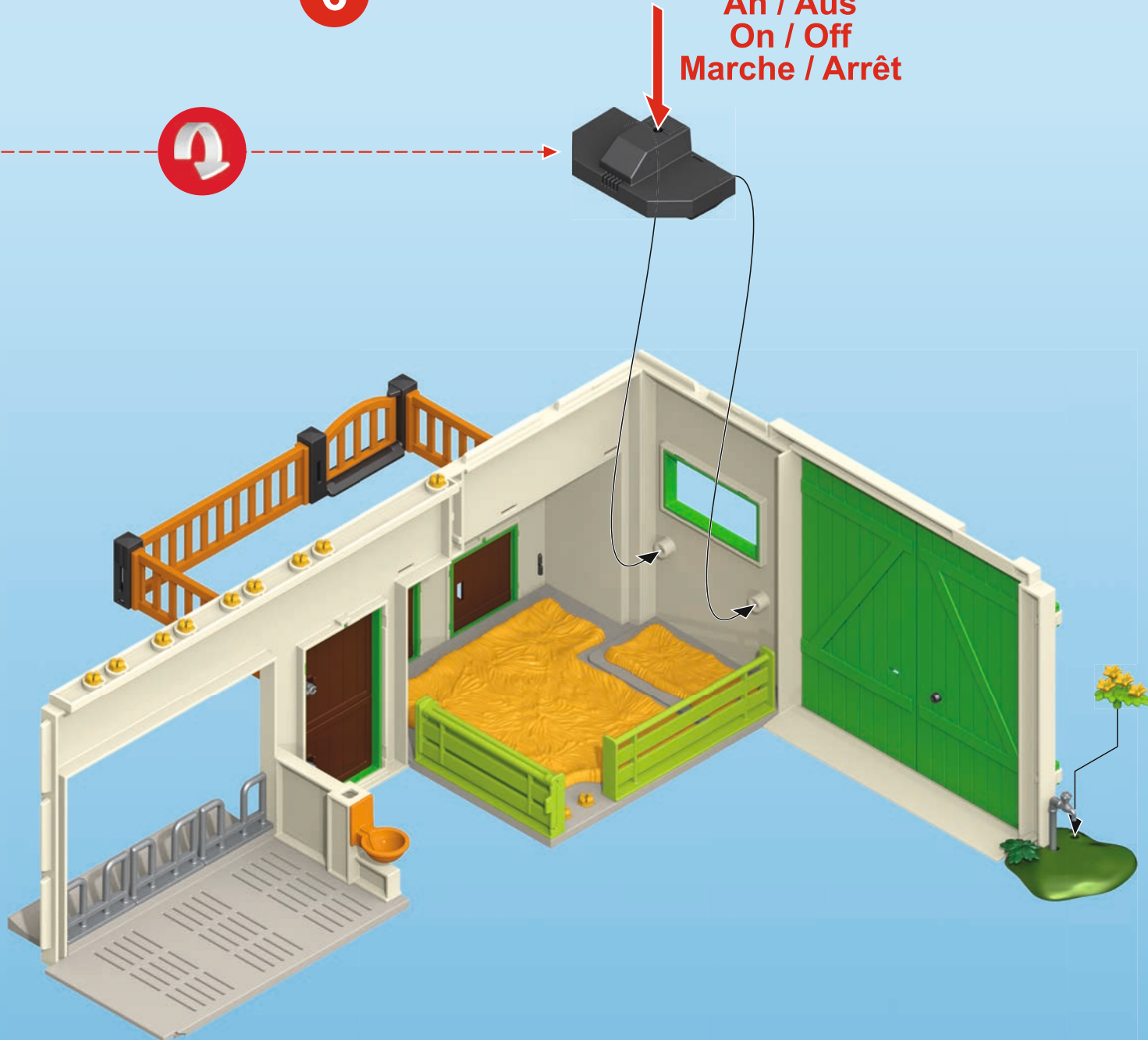

<p>DE AT CH LU BE Nur angegebene Batterien verwenden. Nicht wiederaufladbare Batterien dürfen nicht geladen werden. Aufladbare Batterien dürfen nur unter Aufsicht von Erwachsenen geladen werden. Aufladbare Batterien sind aus dem Spielzeug herauszunehmen, bevor sie geladen werden. Ungleiche Batterietypen oder neue und gebrauchte Batterien dürfen nicht zusammen verwendet werden. Batterien müssen mit der richtigen Polarität eingelegt werden. Leere Batterien müssen aus dem Spielzeug herausgenommen werden. Die Anschlussklemmen dürfen nicht kurzgeschlossen werden. Batterien regelmäßig auf Auslaufen überprüfen. Verbrauchte Batterien nicht in den Hausmüll werfen, sondern nur bei den bestehenden Sammelstellen oder einem Sondermüllplatz abgeben.</p>	<p>LV Izmantot tikai norādītās baterijas. Neuzlādēt baterijas, kuras nedrīkst atkārtoti uzlādēt. Uzlādējamas baterijas drīkst uzlādēt tikai pieaugušo uzraudzībā. Uzlādējamas baterijas pirms uzlādēšanas izņemt no transportlīdzekļa. Neizmantojiet kopā atšķirīgu bateriju tipus vai jaunas un lietotas baterijas. Ievietojiet baterijas, ievērot polaritāti. Tukšās baterijas no rotālietas jāizņem. Pieslēguma spailes nedrīkst saslēgt ieslēgumā. Regulāri pārbaudīt, vai baterijas nav iztecējušas. Lietotas baterijas neizmest kopā ar sadzīves atkritumiem, bet gan esošajās bateriju savākšanas vietās vai speciālā atkritumu izvešanas vietā.</p>
<p>US GB CA MT IE Only use the stipulated batteries. Non-rechargeable batteries are not to be charged. Rechargeable batteries are only to be charged under adult supervision. Rechargeable batteries are to be removed from the toy before they are recharged. Neither different battery types nor new and used batteries are to be used together. Batteries must be inserted with the correct polarity. Flat batteries are to be removed from the toy. The connecting terminals are not to be short-circuited. Inspect batteries regularly for signs of leakage. Do not dispose of used batteries in the household waste but hand them in at the existing collection points or at a special waste site.</p>	<p>LT Naudoti tik nurodytas baterijas. Vienkartinųjų baterijų įkrauti negalima. Daugkartinio naudojimo baterijos turi būti įkraunamos suaugusiųjų priežiūroje. Prieš įkraunant daugkartinio naudojimo baterijas, jas reikia išimti iš žaislo. Negalima kartu naudoti skirtingų tipų, arba naujų ir naudotų baterijų. Baterijas reikia įdėti, atsižvelgiant į teisingą poliškumą. Išsikrovusias baterijas reikia išimti iš žaislo. Negalima alikiti trumpo jungiančių gnybtų jungimo. Reguliariai tikrinkite ar baterijos nėra išsivargę. Naudotų baterijų negalima išmesti kartu su buitiniomis atliekomis. Jas reikia atiduoti į esamas surinkimo vietas arba į pavojingų atliekų surinkimo aikštelę.</p>
<p>FR CA BE LU CH Seulement utiliser le modèle de piles indiqué. Ne pas recharger de piles non rechargeables. Seulement recharger des piles rechargeables en présence d'adultes. Öter les piles rechargeables du jouet avant de les recharger. Ne pas utiliser de piles de différents types en même temps ni de piles neuves avec des piles anciennes. Attention à introduire correctement les piles en tenant compte de leur polarité. Öter les piles usées du jouet. Ne pas court-circuiter les bornes. Vérifier régulièrement si les piles coulent. Ne pas jeter de piles usées avec les ordures ménagères, les déposer dans les centres de récupération.</p>	<p>SI Uporabljajte le navedene baterije. Baterij, ki niso namenjene za polnjenje, ni dovoljeno polniti. Baterije, ki se jih sme polniti, je dovoljeno polniti le pod nadzorom odraslih oseb. Pred polnjenjem je baterije, ki se lahko polnijo, potrebno vzeti iz igrače. Skupaj ni dovoljeno uporabljati različnih vrst baterij ali novih in rabljenih baterij. Baterije je potrebno vstaviti pravilno obrnjene – s pravilno polariteto. Prazne baterije je potrebno vzeti iz igrače. Na priključnih spdkah ni dovoljeno povzročati kratkega stika. Redno preverjajte, ali baterije ne iztekajo. Izrabljenih baterij ne odlagajte med gospodinjске odpadke, ampak jih oddajte na birmih mestih oz. na zbirališču posebnih odpadkov.</p>
<p>ES MX Utiliza únicamente las pilas descritas. No recargues pilas no recargables. Recarga las pilas recargables únicamente bajo supervisión de un adulto. Sacas las pilas recargables del juguete antes de recargarlas. No utilices juntas pilas de tipos diferentes ni tampoco pilas nuevas con pilas usadas. Inserta las pilas con la polaridad correcta. Sacas del juguete las pilas gastadas. No pongas en cortocircuito los bornes de conexión. Comprueba periódicamente si se ha producido una fuga en las pilas. No eches las pilas gastadas a la basura doméstica, deséchelas únicamente en los puestos de recogida previstos o en un depósito de basura especial.</p>	<p>SK Používajte len uvedené batérie. Batérie, ktoré nie sú nabíjateľné, sa nesmú nabíjať. Nabíjateľné batérie sa smú nabíjať len pod dohľadom dospelých osôb. Nabíjateľné batérie je potrebné pred nabíjaním vybrať z hračky. Nerovnaké typy batérií alebo nové a použité batérie sa nesmú spoločne používať. Batérie sa musia vložiť so správnou polaritou. Prázdne batérie sa musia z hračky vybrať von. Pripojovacie svorky sa nesmú skratovať. Batérie pravidelne kontrolujte, či nevytekajú. Opotrebované batérie nevyhadzujte do domového odpadu, ale ich odovzdajte na existujúcich zberných miestach alebo na skládke špeciálneho odpadu.</p>
<p>NL BE Uitsluitend de aangegeven batterijen gebruiken. Niet-herlaadbare batterijen mogen niet geladen worden. Herlaadbare batterijen mogen alleen onder toezicht van volwassenen geladen worden. Opladbare batterijen moeten uit het speelgoed genomen worden vooraleer ze te laden. Ongelijke batterijtypes of nieuwe of gebruikte batterijen mogen niet samen gebruikt worden. Batterijen moeten met de correcte polen ingelegd worden. Lege batterijen moeten uit het speelgoed genomen worden. De aansluitingsklemmen mogen niet kortgesloten worden. Regelmatig controleren of de batterijen niet uitgelopen zijn. Lege batterijen niet met het huisvuil verwijderen, maar alleen bij bestaande verzamelcentra of een plaats voor bijzondere afval afgeven.</p>	<p>PL Stosować tylko wskazane baterie. Zwykłe baterie, nie nadające się do powtórznego ładowania, nie mogą być ładowane. Baterie nadające się do powtórznego ładowania (akumulatorki) mogą być ładowane tylko pod kontrolą osób dorosłych. Przed ładowaniem baterie-akumulatorki należy wyjąć z zabawki. Nie stosować równocześnie baterii różnych typów ani baterii nowych wraz z używanymi. Podczas zakładania baterii zwrócić uwagę na ich prawidłową polaryzację. Rozładowane baterie usunąć z zabawki. Nie zwierać zacisków. Regularnie sprawdzać, czy baterie nie wyciekają. Zużyte baterie nie wyrzucać do kosza na śmieci, tylko oddać w odpowiednich punktach zbiórki lub wrzucać do przeznaczonych do tego celu specjalnych pojemników.</p>
<p>IT CH Usare solo le batterie indicate. E' vietato utilizzare le batterie ricaricabili. Le batterie ricaricabili devono essere caricate soltanto in presenza di adulti. Le batterie ricaricabili si estraggono dal giocattolo, prima di essere caricate. I tipi di batteria non uguali o nuovi e le batterie esauste non devono essere usate insieme. Le batterie vanno inserite rispettando la corretta polarità. Le batterie esaurite devono essere rimosse dal giocattolo. I morsetti di collegamento non devono essere messi in corto circuito. Verificare ad intervalli regolari che le batterie non si siano esaurite. Le batterie esauste non vanno smaltite insieme ai rifiuti domestici, bensì portate nei punti di raccolta o nei centri di raccolta per rifiuti speciali.</p>	<p>TR CY Yalnızca belirtilen pilleri kullanınız. Şarj edilemeyen piller şarj edilmemelidir. Şarj edilebilir piller yalnızca yetiřkinlerin gözetiminde şarj edilmelidir. Şarj edilebilir piller, şarj edilmenden önce oyuncak ięerisinden çıkartılmalıdır. Türleri birbirinden farklı piller veya yeni ve eski pilleri bir arada kullanılmayınız. Piller kutupları dođru olacak şekilde yerleřtirilmelidir. Biten piller oyuncak ięerisinden çıkartılmalıdır. Bađlantı klemensleri kisa devre yapılmamalıdır. Düzenli aralıklarla pillerin akup akmadıklarına kontrol ediniz. Kullanılmıř pilleri ev çöptene atmayınız, yalnızca özel toplama yerlerine atınız veya özel atık merkezine ulařtırınız.</p>
<p>PT Usar apenas as pilhas indicadas. Pilhas não recarregáveis não podem ser carregadas. Pilhas recarregáveis só podem ser carregadas sob supervisão de adultos. Pilhas recarregáveis devem ser retiradas do brinquedo, antes de serem carregadas. Não se pode usar em conjunto diferentes tipos de pilha ou pilhas novas e usadas. Pilhas têm de ser inseridas com a polaridade correcta. Pilhas vazias têm de ser retiradas do brinquedo. Não se podem curto-circuitar os terminais. As pilhas têm de ser controladas regularmente quanto a vazamento. Não deitar pilhas gastas no lixo doméstico, mas depositá-las nos pontos de recolha existentes ou entregá-las no estabelecimento que as comercializa.</p>	<p>GR CY Να χρησιμοποιείτε μόνο μπαταρίες του τύπου που σας υποδεικνύουν οι πληροφορίες ή αντίστοιχες. Ποτέ μην επαναφορτίσετε μη επαναφορτιζόμενες μπαταρίες. Οι επαναφορτιζόμενες μπαταρίες πρέπει να επαναφορτίζονται πάντα από ενήλικα. Αφαιρείτε τις επαναφορτιζόμενες μπαταρίες από την ηλεκτρονική μονάδα του παιχνιδιού πριν τις επαναφορτίσετε. Μην συνδυάζετε μπαταρίες διαφορετικών τύπων, π.χ. αλκαλικές ή επαναφορτιζόμενες με απλές, ή παλιές με καινούριες. Αποθετείστε τις μπαταρίες με την σωστή πολικότητα. Όταν αδειάζουν οι μπαταρίες πρέπει να απομακρύνονται από το παιχνίδι. Ποτέ μη βραχυκυκλώνετε τους πόλους. Πάντα να ελέγχετε τις μπαταρίες για τυχόν διαρροές. Μην πετάτε ποτέ στα οικιακά απορριμμάτα τις παλιές μπαταρίες, παρά μόνο σε ειδικούς κάδους ανακύκλωσης της αντίστοιχης ένδειξη. Για τον κατάλληλο τρόπο ανακύκλωσης, παρακαλούμε επικοινωνήστε με τους τοπικούς φορείς.</p>
<p>DK Anvend kun de angivne batterier. Ikke genopladelige batterier må ikke oplades. Genopladelige batterier må kun oplades under opsyn af voksne. Genopladelige batterier skal tages ud af legetøjet, inden de oplades. Forskellige batterityper eller nye og brugte batterier må ikke anvendes sammen. Batterier skal isættes med den rigtige polaritet. Tomme batterier skal tages ud af legetøjet. Tilslutningsklemmerne må ikke kortsluttes. Kontrollør regelmæssigt batterierne for lækage. Opbrugte batterier må ikke bortskaffes som almindeligt husholdningsaffald, men skal afleveres på et officielt sted for indsamling af brugte batterier eller på den kommunale genbrugsstation.</p>	<p>RO Se vor folosi doar bateriile specificate. Bateriile fără reîncărcare nu au voie să se încarce. Bateriile reîncărcabile se vor încărca doar sub supravegherea adulților. Bateriile reîncărcabile se scot din jucărie înainte de încărcare. Nu este permisă utilizarea împreună a bateriilor de tipuri diferite sau a bateriilor noi cu cele vechi. Bateriile trebuie introduse cu polaritatea corectă. Bateriile descărcate trebuie scoase din jucărie. Bornele nu au voie să fie scurtcircuitate. Bateriile trebuie verificate în mod regulat să nu prezinte scurgeri. Bateriile consumate nu se aruncă la deșeurile menajere, ci se predau la centrele existente de colectare sau în locurile pentru deșeuri speciale.</p>
<p>NO Benytt kun angitte batterier. Batterier som ikke kan gjenopplades må ikke lades opp. Oppladbare batterier må bare lades opp under tilsyn av voksne. Oppladbare batterier må tas ut av leketøyet før de lades opp. Ulike batterityper eller nye og brukte batterier må ikke benyttes sammen. Batterier må legges inn med riktig polaritet. Tomme batterier må tas ut av kjøretøyet. Kopplingsklemmene må ikke kortsluttes. Kontrollør batteriene regelmessig for om de lekker ut. Ikke kast oppbrukte batterier i husholdningsavfallet, men lever dem til lokale miljøstasjoner eller til en plass for spesialavfall.</p>	<p>BG Използвайте само посочените батерии. Непредназначени за зареждане батерии не бива да бъдат зареждани. Зареждащите се батерии трябва да бъдат зареждани само под надзора на възрастни. Зареждащите се батерии се изваждат от играчката, преди да се поставят за зареждане. Не използвайте заедно нееднакви модели батерии и нови и употребявани батерии не бива да се използват заедно. Поставяйте батериите, обръщайки внимание на правилния поларитет. Празните батерии трябва да бъдат изваждани от играчката. Свързващите клемми не трябва да бъдат давани на късо. Редовно проверявайте батериите за течове. Не изхвърляйте употребяваните батерии като домашни отпадъци, а ги предавайте само на специално определени за това места или в депо за специални отпадъци.</p>
<p>SE FI Använd endast angivna batterier. Batterier som inte är uppladdbara får inte laddas. Uppladdbara batterier får endast laddas om en vuxen person hjälper dig. Ta ur de uppladdbara batterierna ur fordonet innan de laddas. Använd inte olika batterityper samtidigt, använd heller inte ett nytt och ett gammalt batterie samtidigt. Se till att batterierna ligger åt rätt håll, det finns symboler på batterierna och i batterifacket. Ta ur tomma batterier ur leksaken. Lägg inte ihop anslutningsklämmorna, de kan bli kortslutning. Kontrollera regelbundet att batterierna inte läcker batterisyra. Gamla batterier hör inte hemma i vanliga hushållsopor. Kasta batterier i speciella batteriuppsamlare eller lämna dem till soptippen som specialavfall.</p>	<p>HR Koristiti samo navedene baterije. Baterije za ponovno punjenje se ne smiju koristiti. Baterije za ponovno punjenje se smiju puniti samo pod nadzorom odraslih. Baterije za ponovno punjenje se prije punjenja moraju izvaditi iz igračke. Baterije raznih tipova ili nove i rabljene se ne smiju skupa upotrebljavati. Baterije se moraju umetnuti sa točnim polaritetom. Prazne baterije se moraju izvaditi iz igračke. Priključne stazaljke se ne smiju kratko spojati. Baterije redovito provjeravati u svezi curenja. Istrošene baterije ne bacati u kućno smeće, već ove odnijeti na postojeća sabirna mjesta ili predati na drugo mjesto za posebno smeće.</p>
<p>FI Käytää vain ilmoitettuja paristoja. Ei saa ladata paristoja, jotka eivät ole ladattavia. Ladattavat paristot saa ladata vain aikuisen valvonnassa. Ladattavat paristot on poistettava leikkikalusta ennen lataamista. Erilaisia paristotyyppöjää tai uusia ja käytettyjä paristoja ei saa käyttää yhdessä. Paristot on asetettava paikoilleen navat oikein päin. Tyhjät paristot on poistettava leikkikalusta. Liittimien oikosuiku ei ole sallittua. Tarkista säännöllisesti, että paristot eivät vuoda. Älä heitä käytettyjä paristoja talousjätteeseen, vain toimita ne vain asiankuuluviin keräyspisteisiin tai ongelmajätteenpaikkaan.</p>	<p>CN 只限使用规定的电池类型。非充电电池不能充电。充电电池只能在成年人监督下充电！充电电池在充电前应该从玩具中取出。不同类型的电池或新旧电池不能混用！电池应以正确的极性放入。用尽的电池应从玩具中取出。电源端子不得短路。用过的旧电池请勿随意丢弃在家庭垃圾中，而是放入回收站或者交给特殊处理处。（说明书上含有重要信息，请保留备用）</p>
<p>HU Csak a megadott elemeket szabad használni. A nem tölthető elemek töltése tilos. A tölthető elemeket csak felnőttek felügyelete mellett szabad tölteni. A feltölthető elemeket ki kell venni a játékból a töltés előtt. Nem egyforma típusú elemek, vagy új és használt elemek együtt nem használhatók. Az elemeket a megfelelő polaritással kell behelyezni. A lemerült elemeket ki kell venni a játékból. A csatlakozó kápcsokat nem szabad rövidre zární. Rendszeresen ellenőrizni kell, hogy az elemek nem folynak-e. A használt elemeket nem szabad a háztartási szemétké dobni, hanem le kell adni egy gyűjtőhelyen vagy veszélyes hulladék állomáson.</p>	
<p>CZ Používejte pouze uvedené baterie. Baterie, které není možno dobíjet, nesmějí být nabíjeny. Nabíjecí baterie smějí být nabíjeny pouze pod dohledem dospělých osob. Nabíjecí baterie musejí být před nabitím vyjmuty z hračky. Různé typy baterií nebo nové a použité baterie nesmějí být použity společně. Je nutno vložit baterie se stejnou polaritou. Prázdné baterie je nutno z hračky vyndat. Pripojovací svorky nesmějí být spojeny nakrátko. Pravidelně kontrolujte, zda baterie nevytékají. Použité baterie neházejte do domovního odpadu, pouze je odevzdejte na stávající sběrná místa nebo stanoviště pro nebezpečný odpad.</p>	
<p>EE Kasutage ainult lubatud patareisid. Laadimisvõimaluseta patareisid on keelatud laadida. Laadimisvõimalusega patareisid tohib laadida ainult täiskasvanud isiku järelevalve all. Laadimisvõimalusega patareid tuleb enne laadimise alustamist mänguasja seest välja võtta. Ärge kasutage korraga erinevat tüüpi või uusi ja kasutatud patareisid. Jälgige patareide paigaldamisel õiget polaarsust. Tühjad patareid tuleb mänguasja seest välja võtta. Ühendusklemmide lühistamine on keelatud. Kontrollige patareisid regulaarselt, et nad ei eraldaks vedelikku. Ärge visake kasutuskoõlmatuid patareisid majapidamisprügi hulka vaid andke need vastavatesse kogumiskohtadesse või ohtlike jäätmete kogumis-punktidesse.</p>	

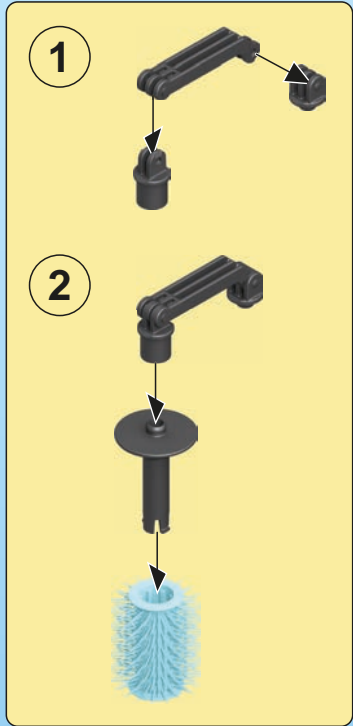

7

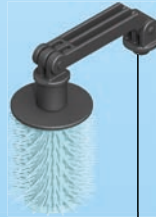

8

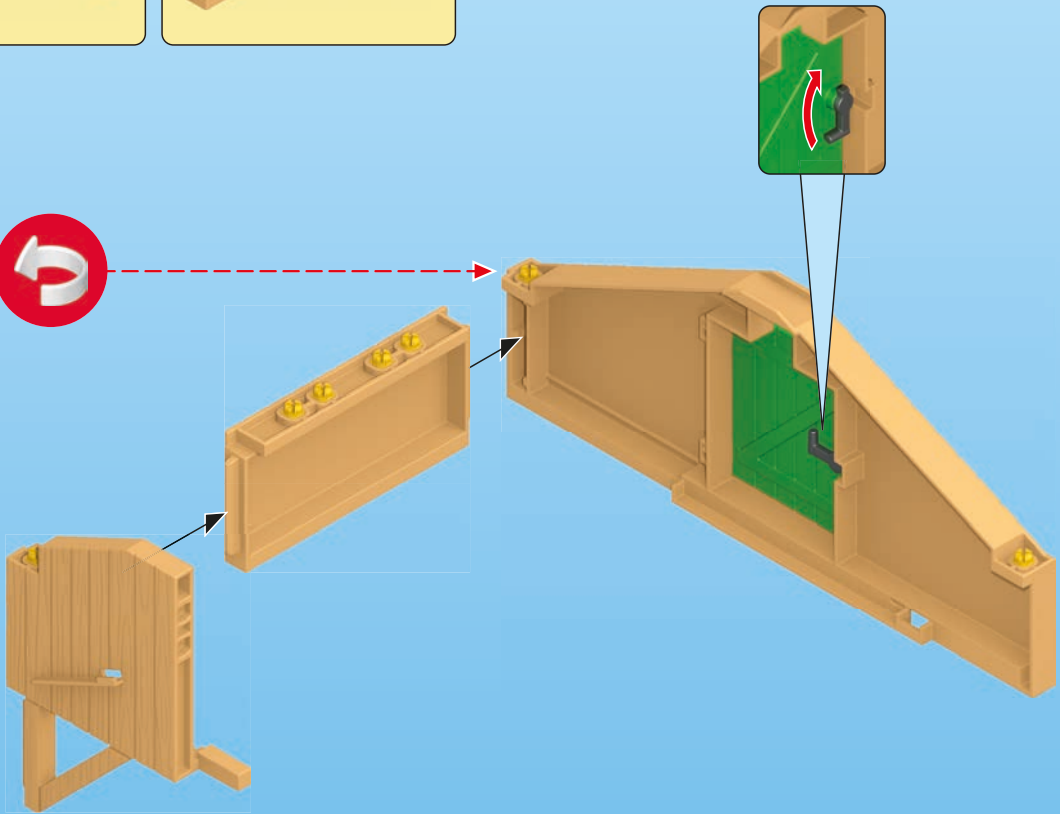
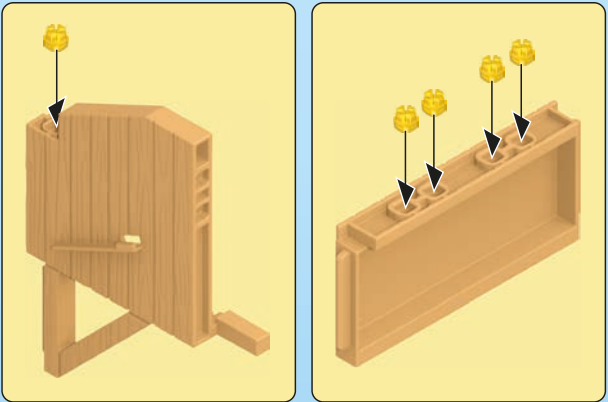
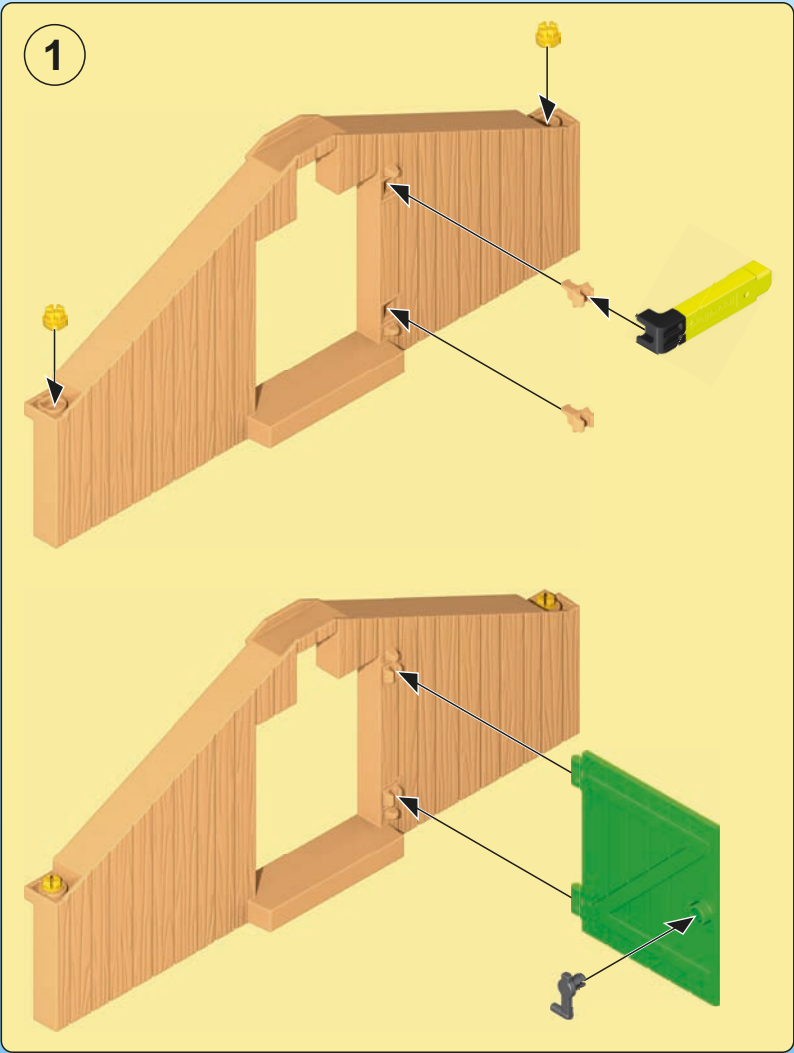

9

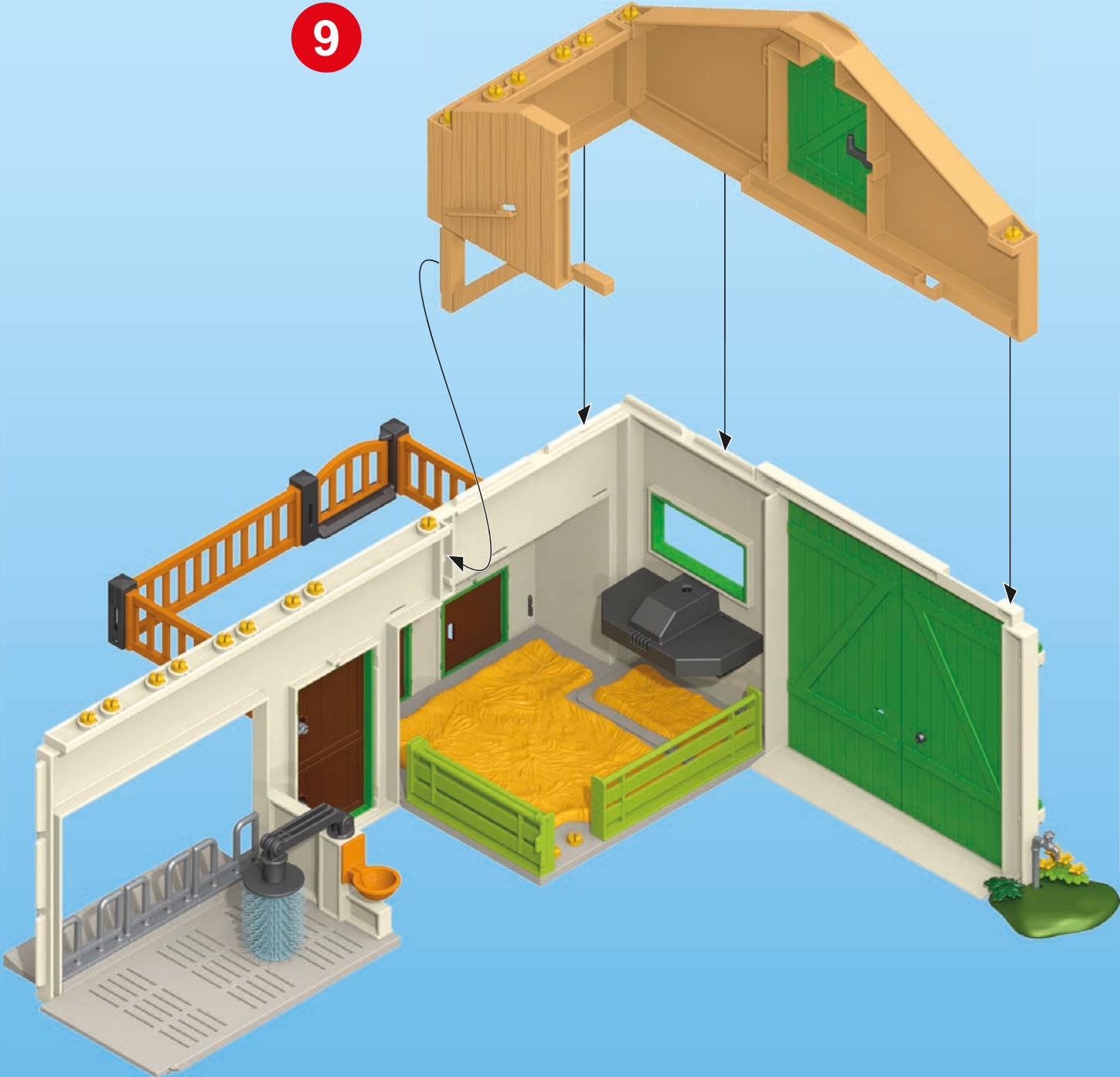

10

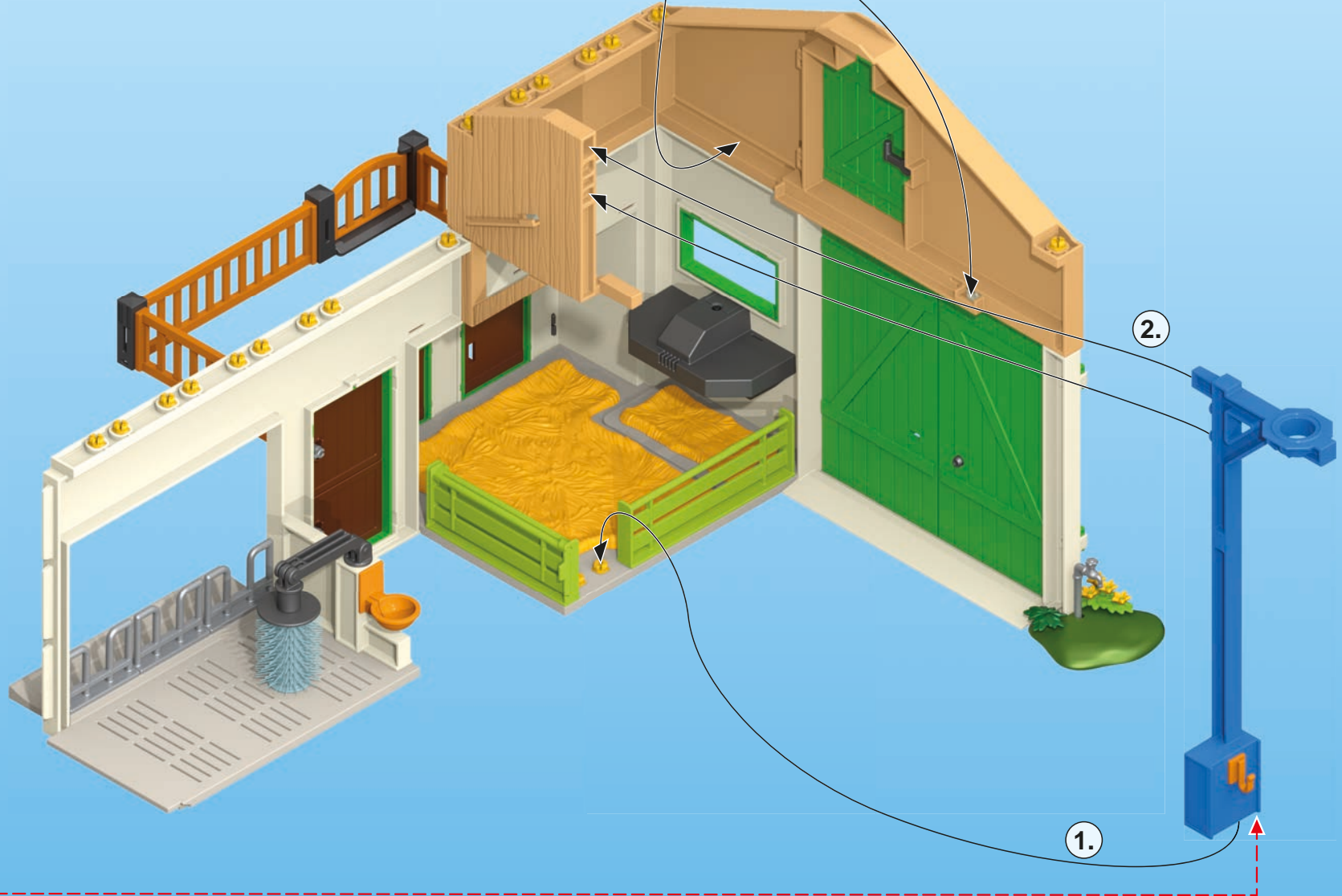
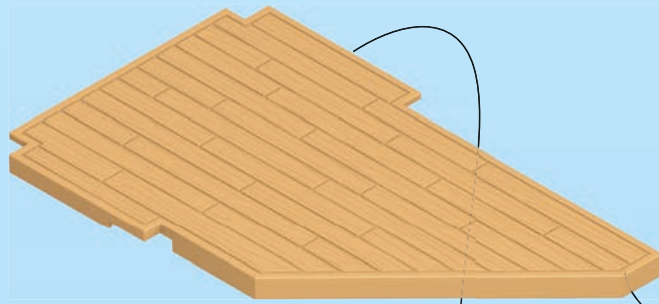
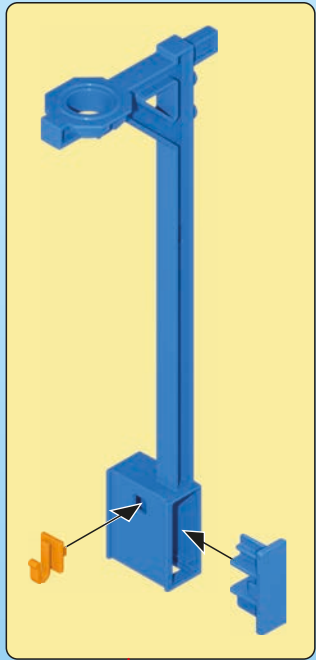

12

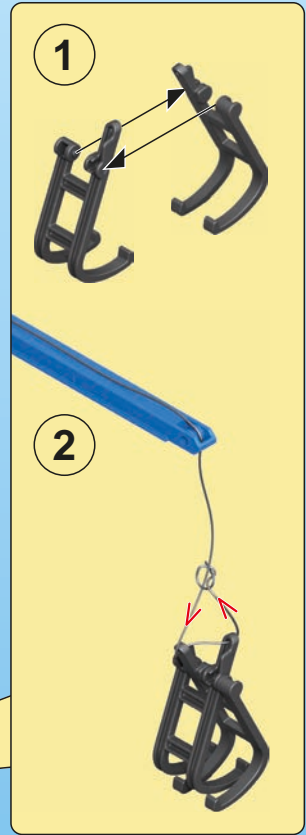

13

1

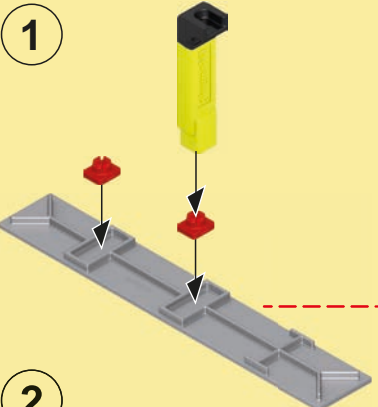

2

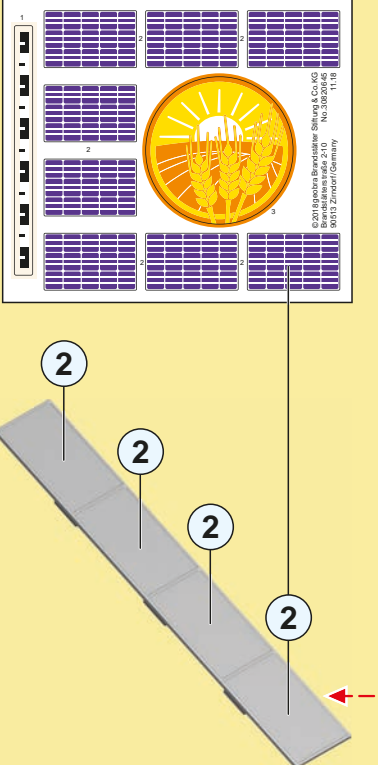

© 2014 Spielzeugbauwerkzeuge Steing & Co. AG
90513 Zirndorf / Germany

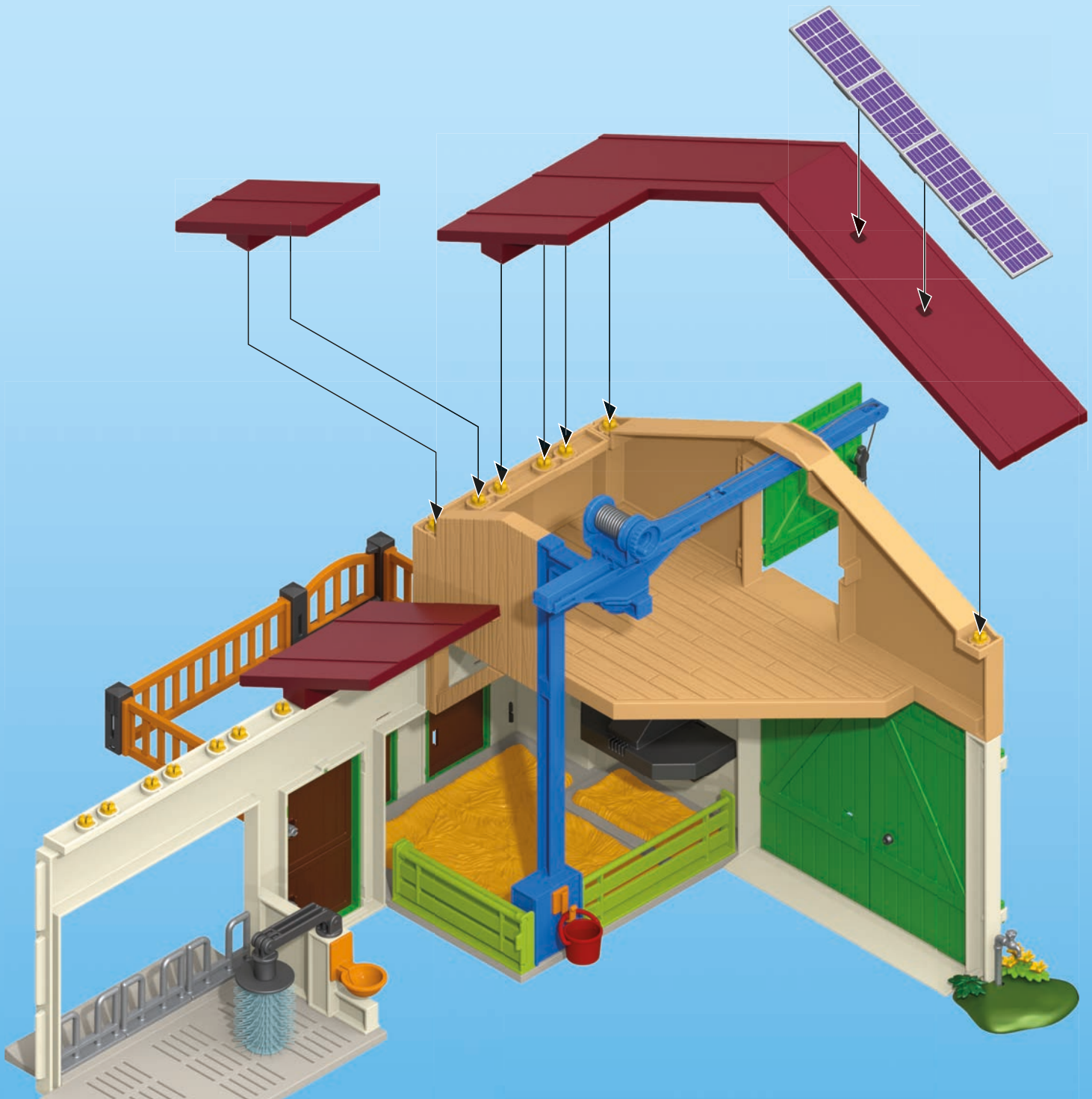

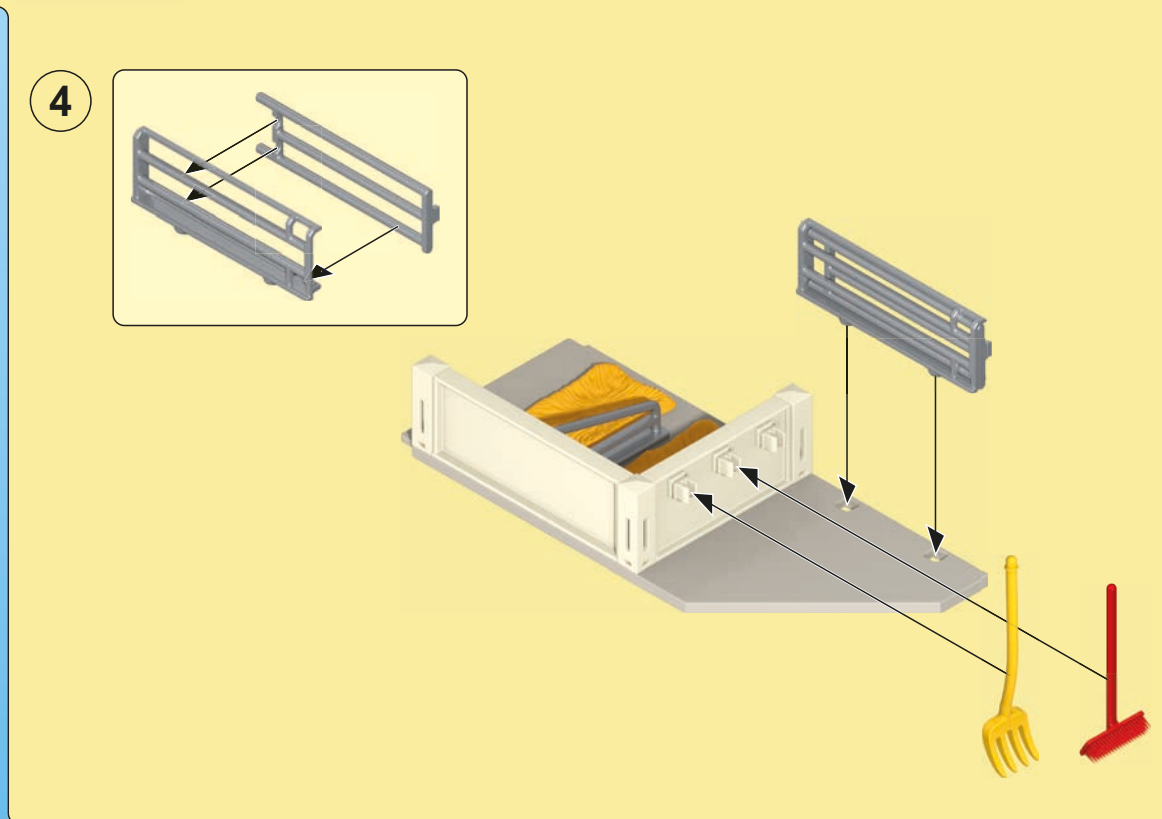
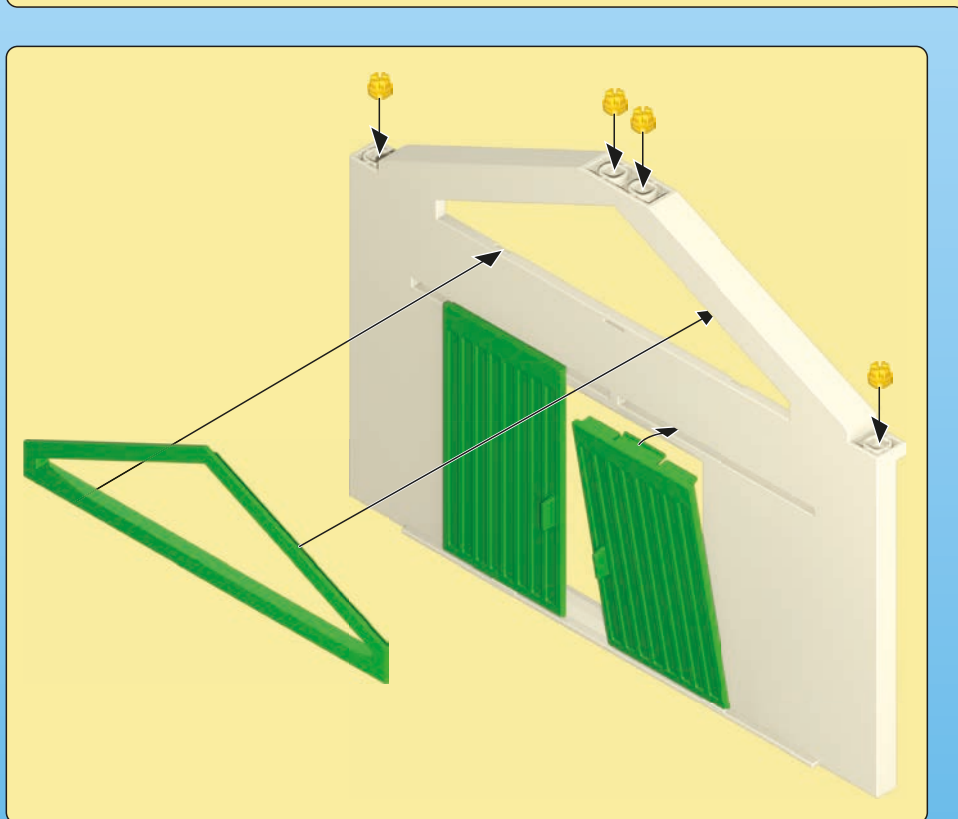
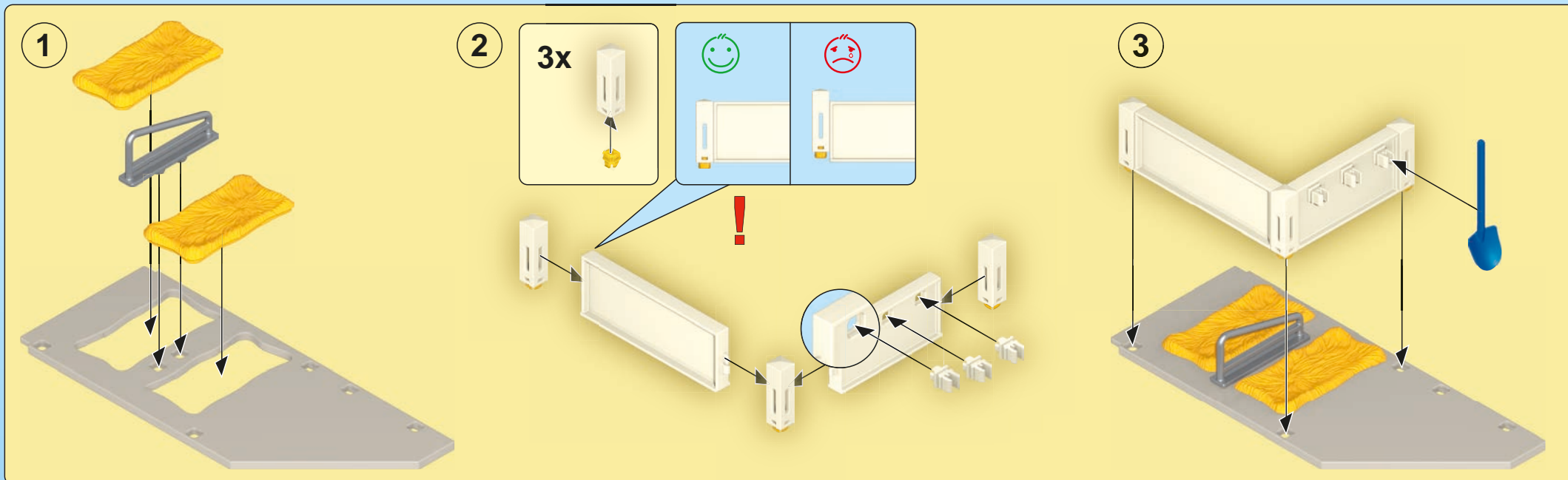

14

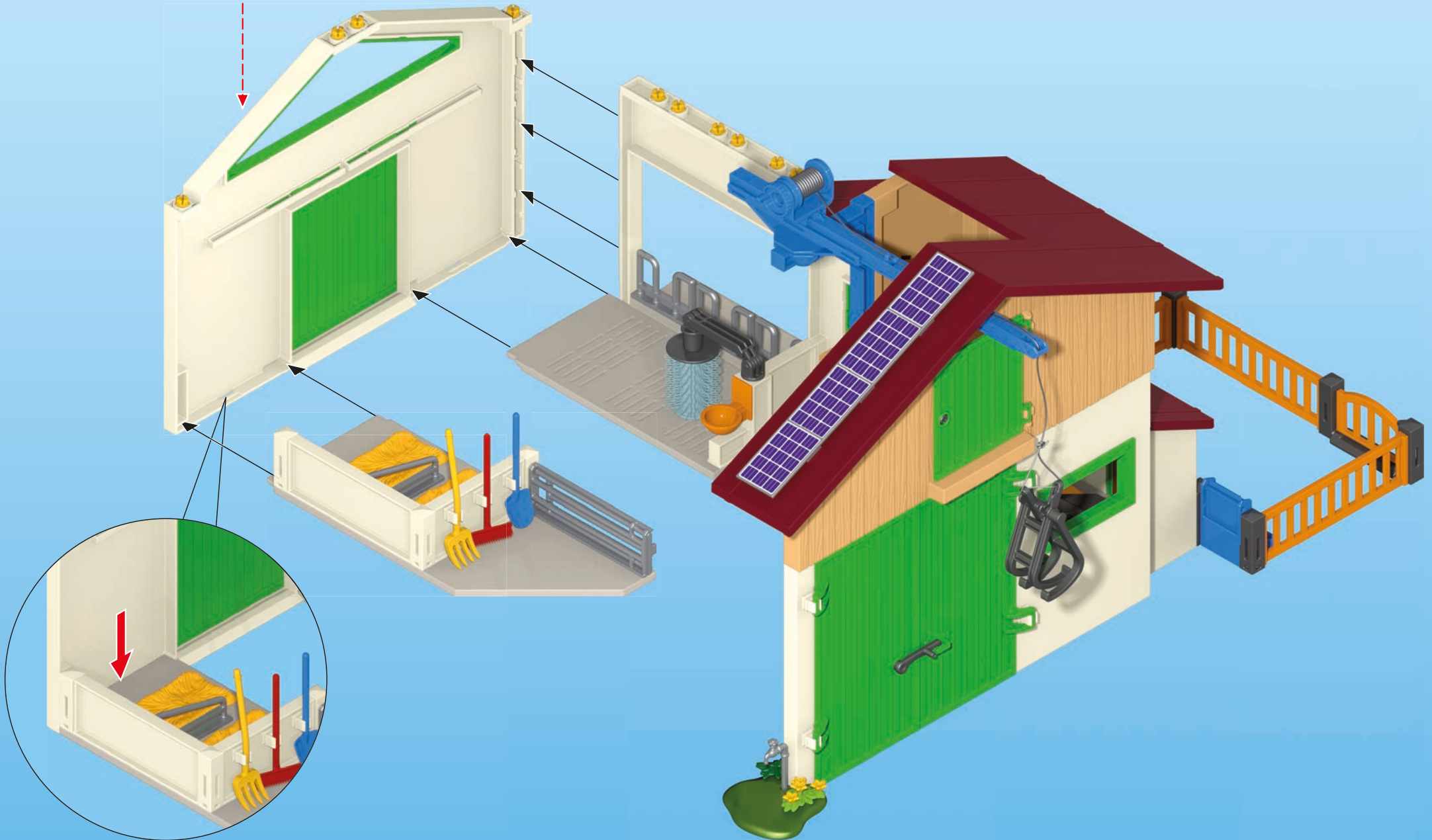

1

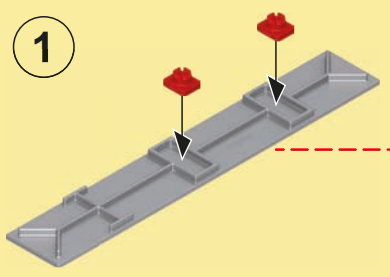

2

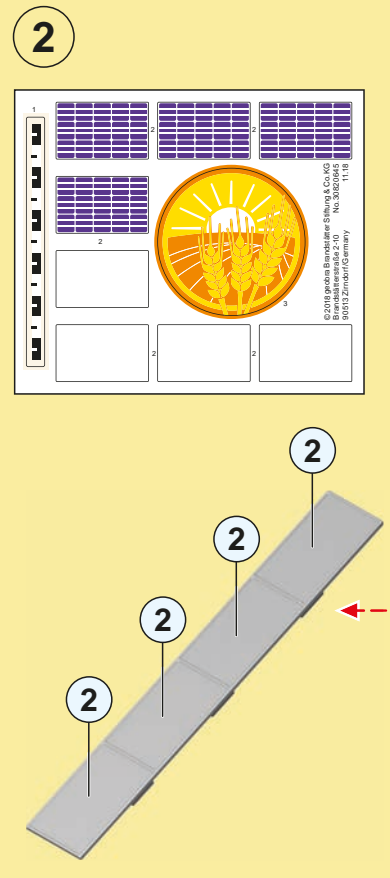

© 2018 Legemil Bau- und Spielzeug GmbH
91033 Zirndorf / Germany

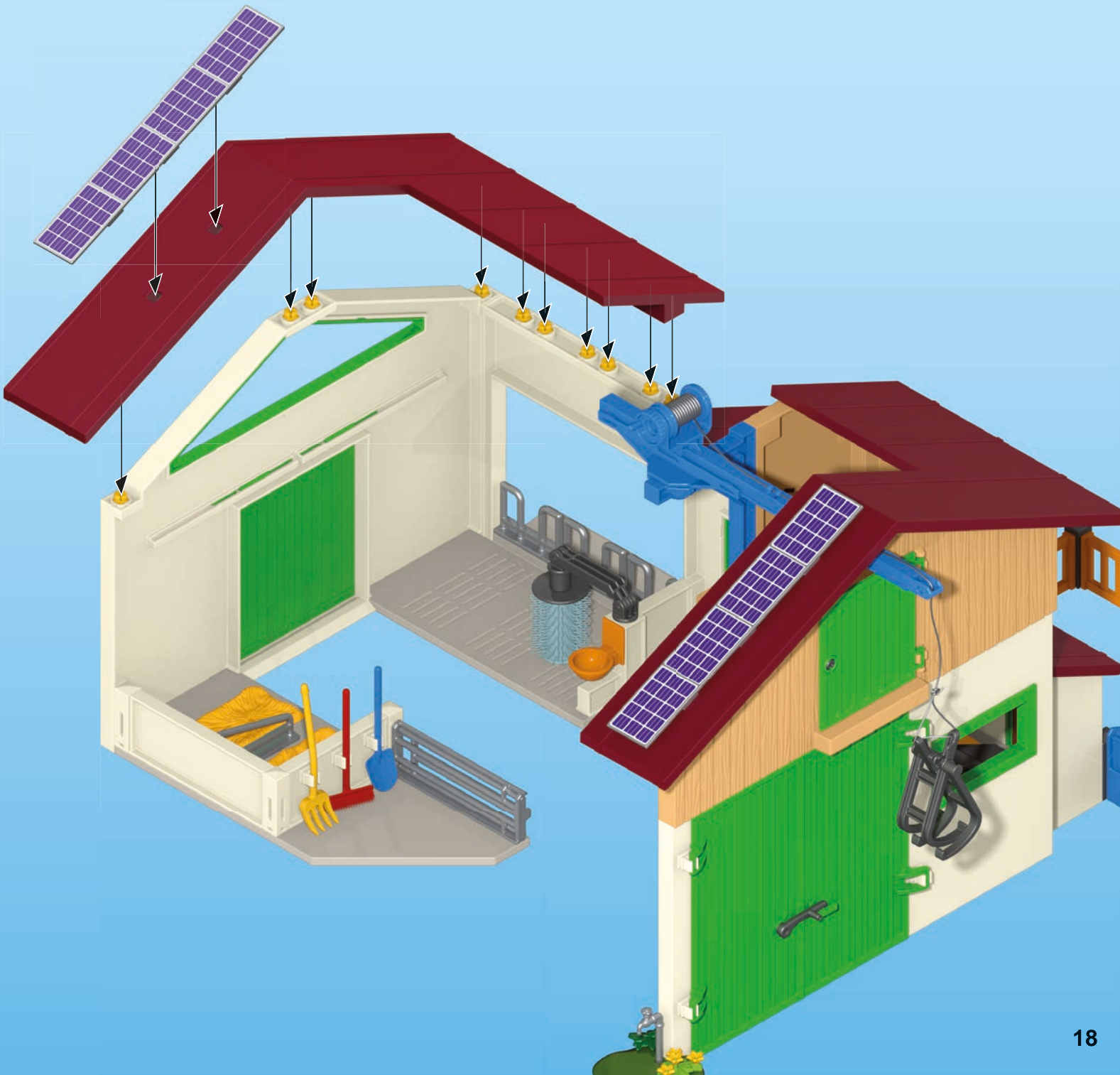

1

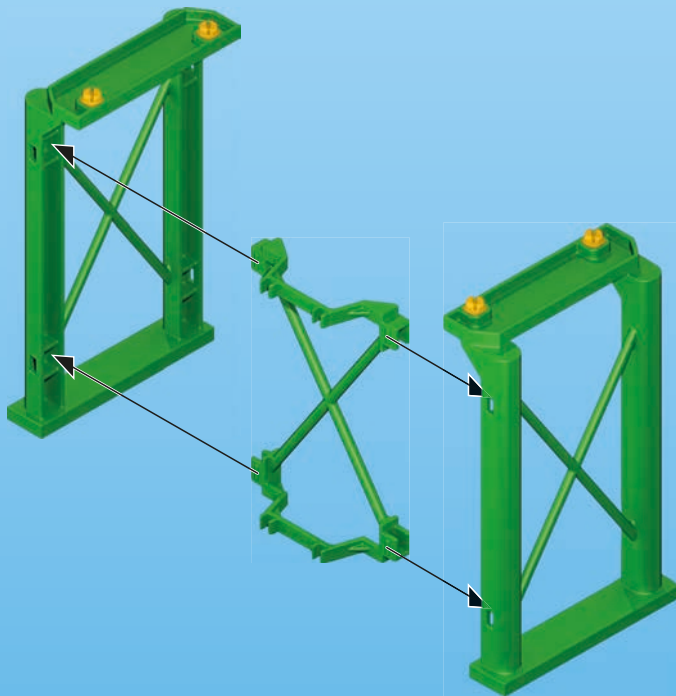

2

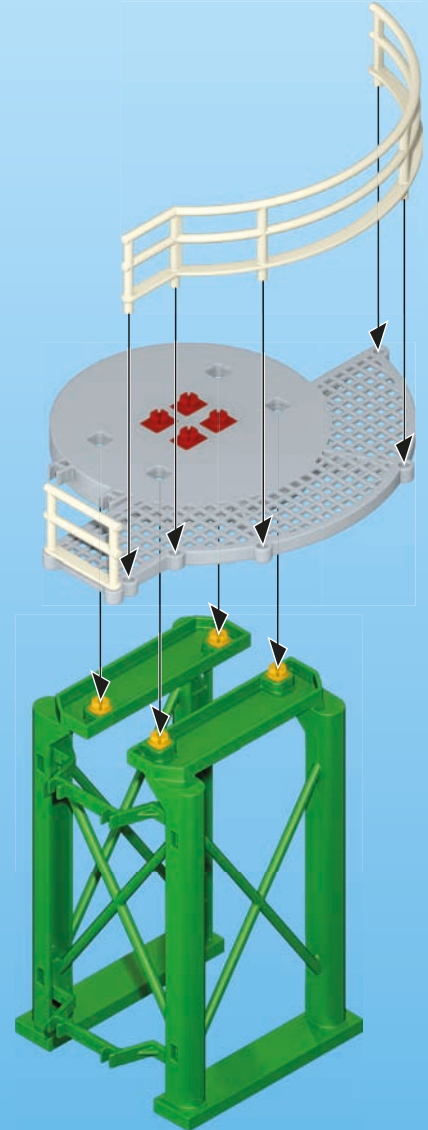
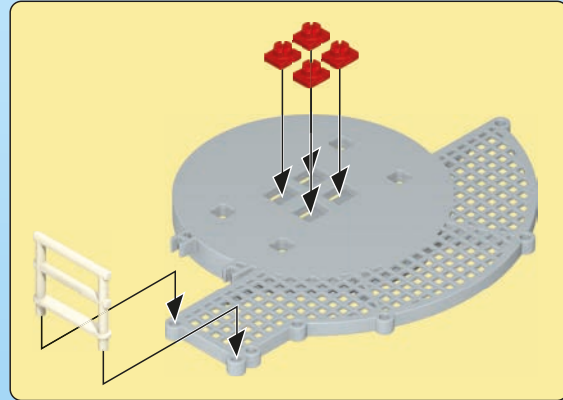

3

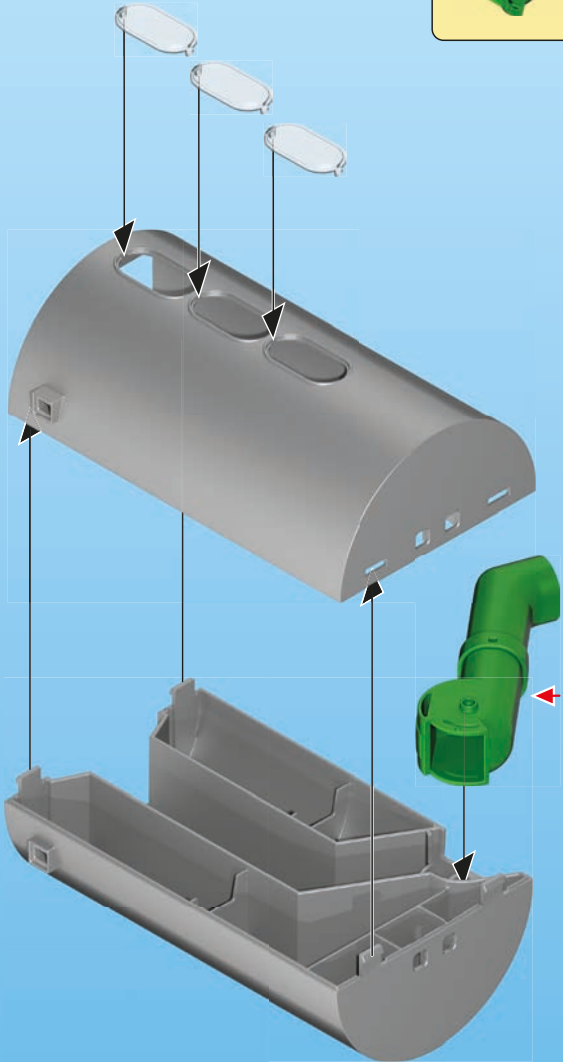

4

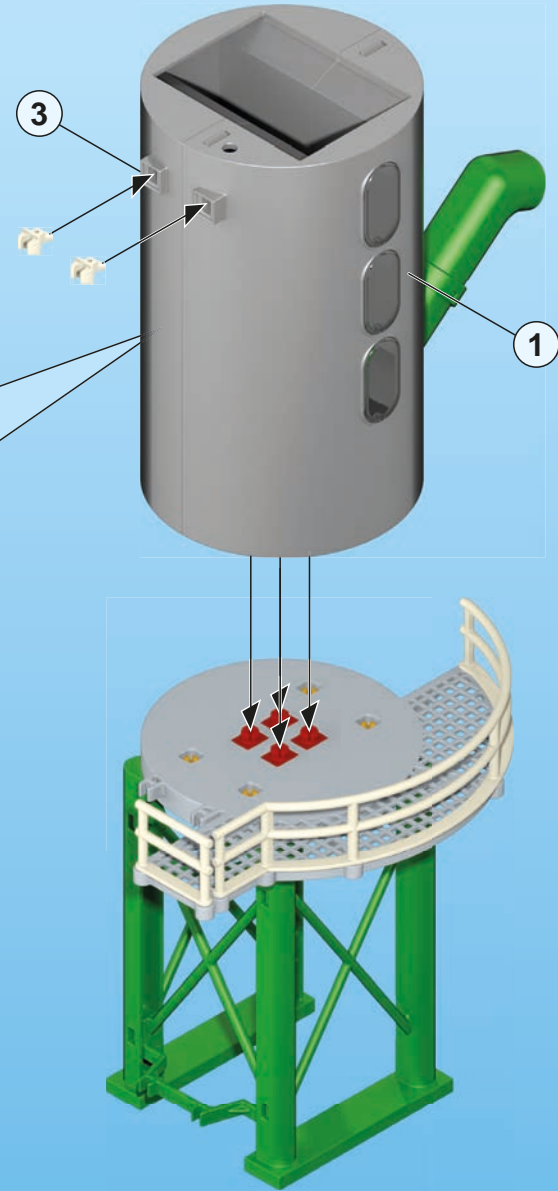
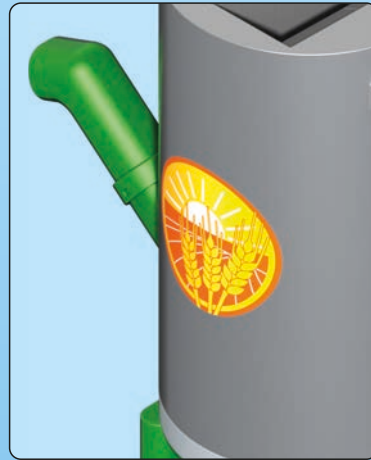
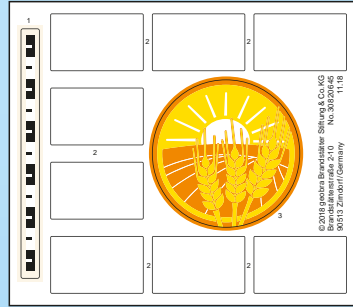

5

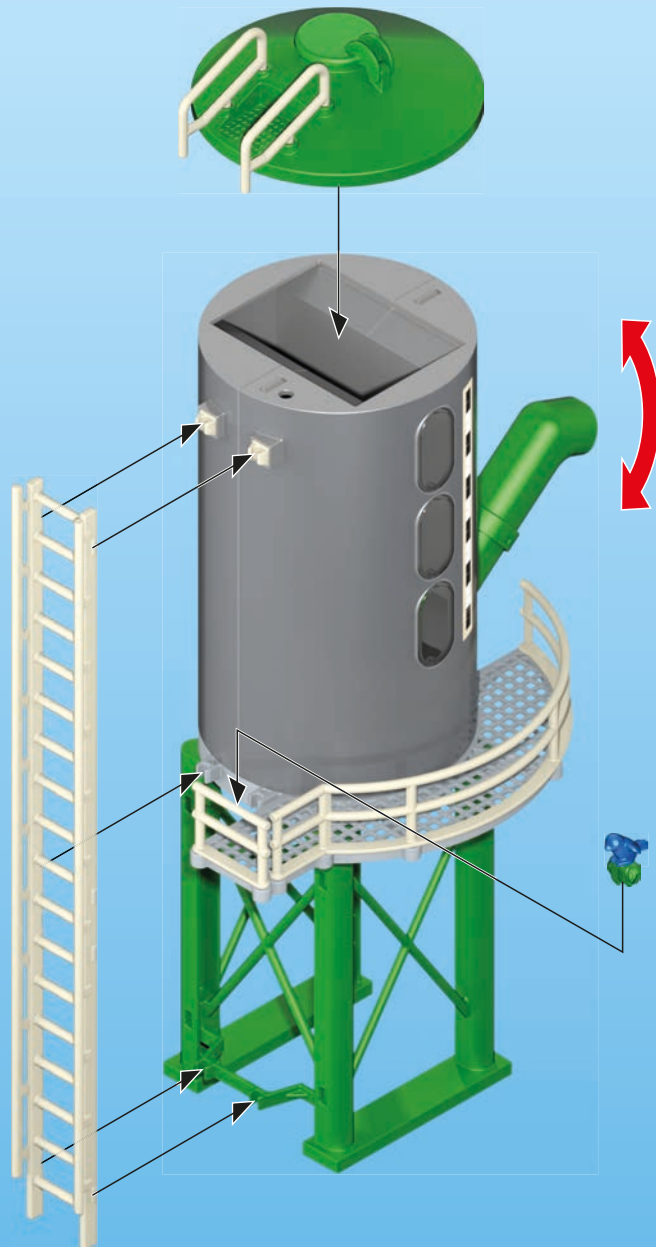
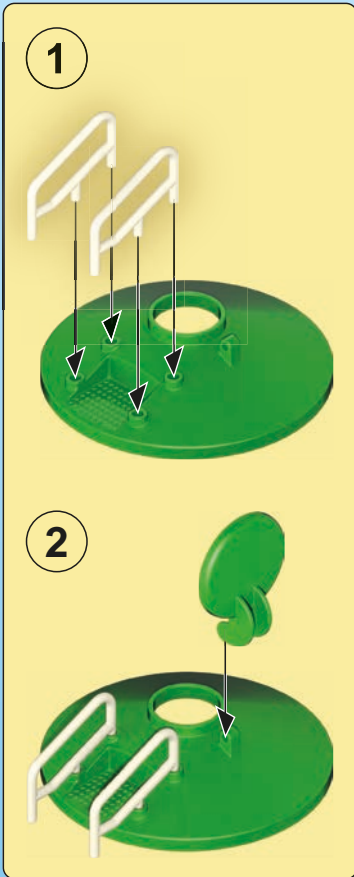

1 **2x**
 30 82 3790
 30 22 4162
 30 22 2742

2
 30 23 1440
 30 22 4152

3 **2x**
 30 66 4983

4
 30 66 8180
 30 22 4172
 30 82 6192

6x
 30 04 7143
 30 21 9213

30 21 1770
 30 82 0980

30 07 4290
 30 07 0900

30 26 6650
 30 26 6650

3x 30 29 8050
 30 29 8050

3x
 30 25 7330
 30 25 7320

30 25 7340
 30 25 7310

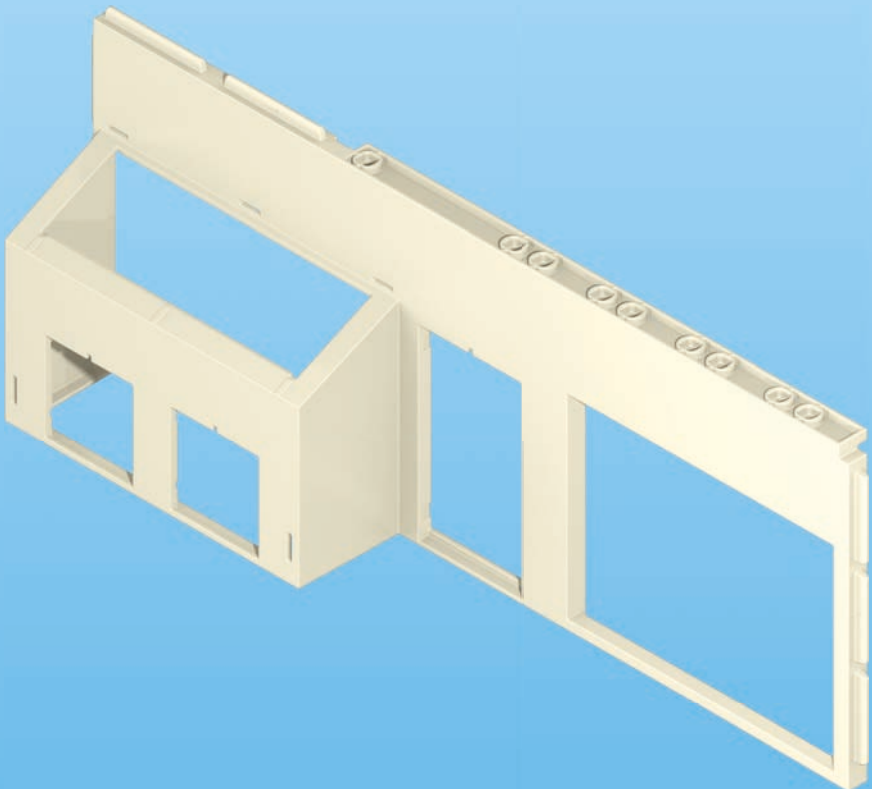
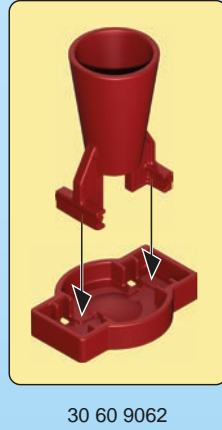
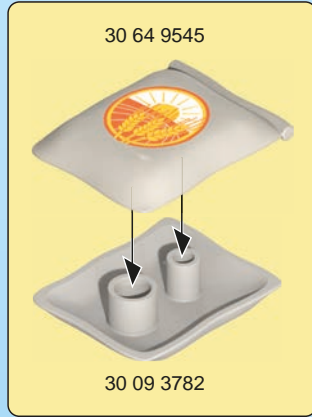
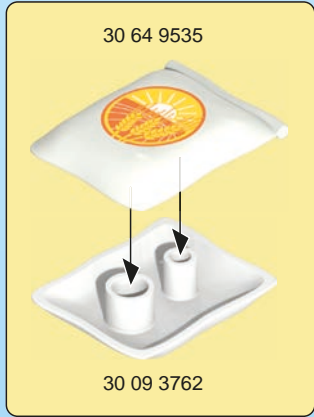

30 03 3323

30 09 3792

30 09 3852

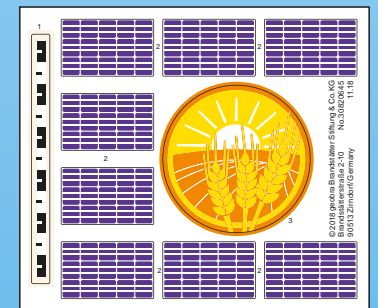

30 82 0645

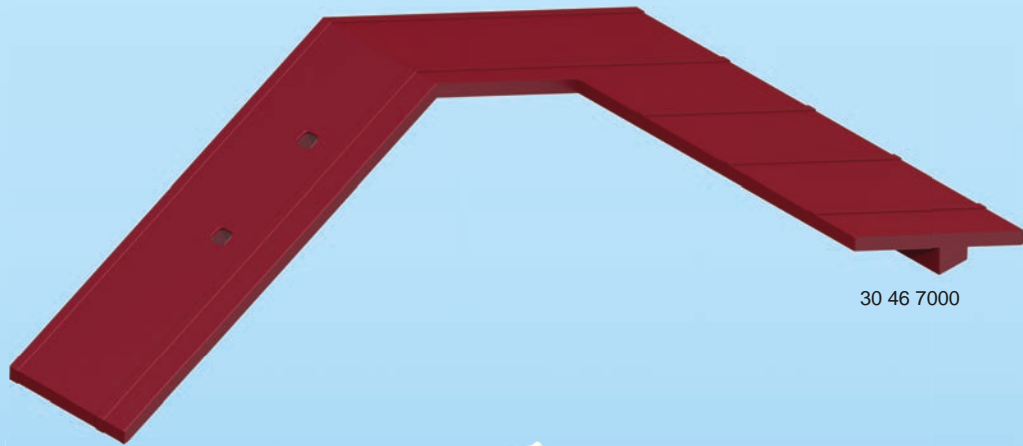

30 46 7000

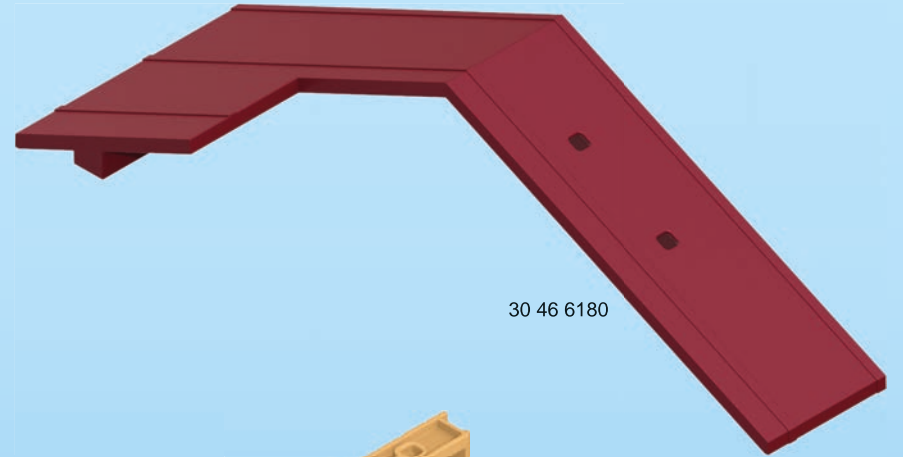

30 46 6180



30 09 3872



30 02 8750



30 03 3023

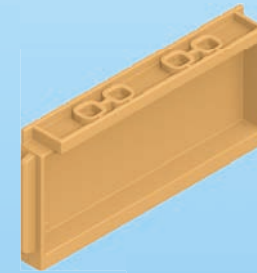

30 45 1732

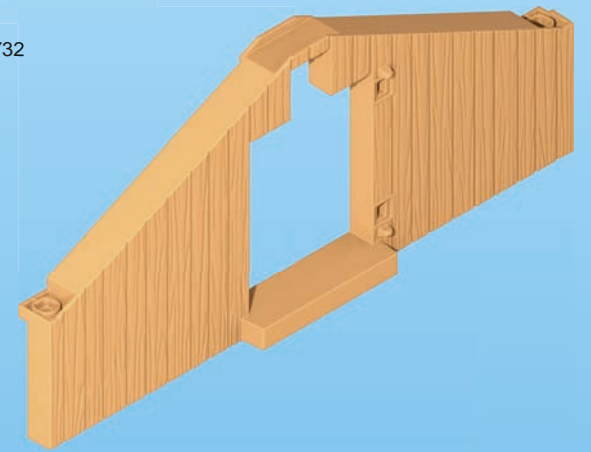

30 09 3932



2x 30 22 2962



2x 30 09 3812

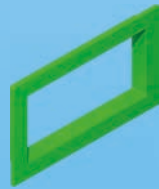

30 09 3892



30 03 3003



30 03 3143



30 22 8460

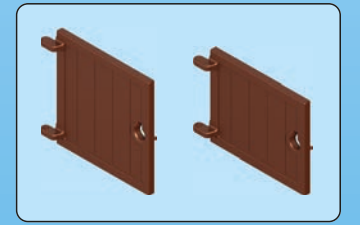

30 60 9072



30 46 5982

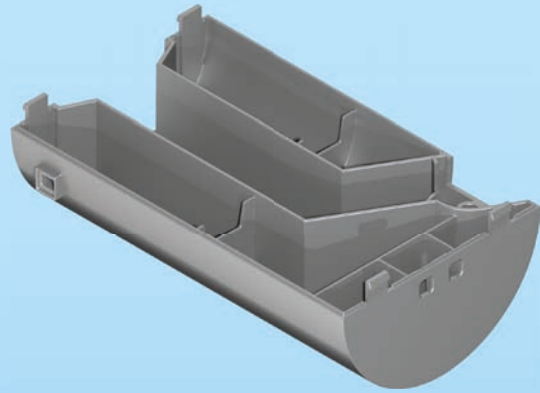

30 46 5362

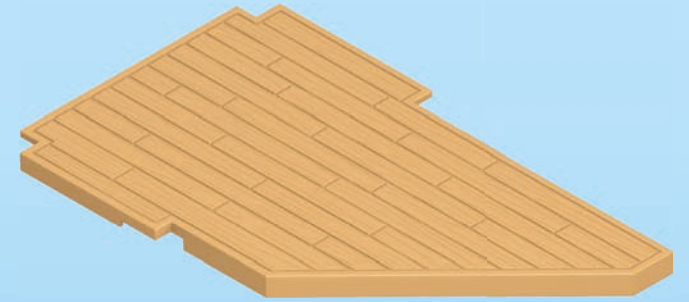

30 45 1752

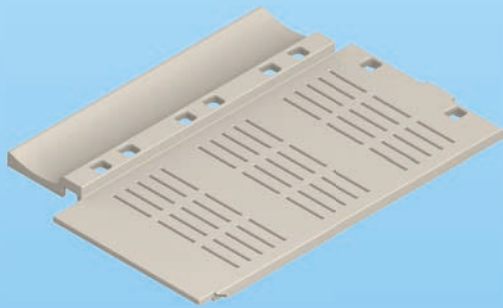

30 09 3842



30 45 1742

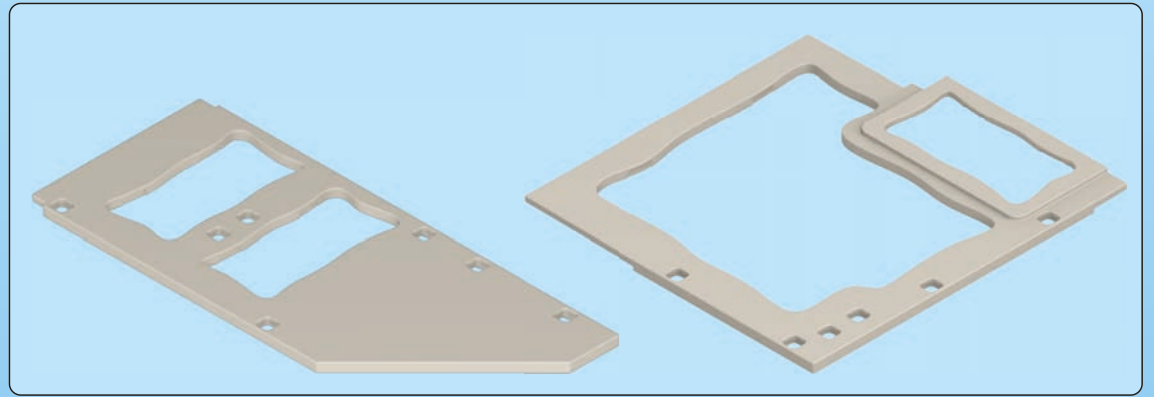

30 51 8552

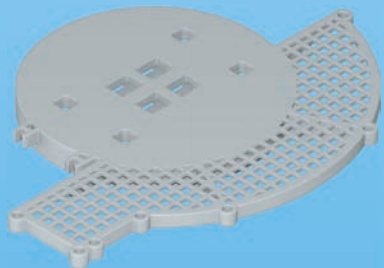

30 03 3283



30 03 3273

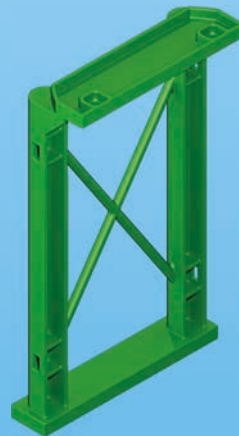

2x 30 03 3263

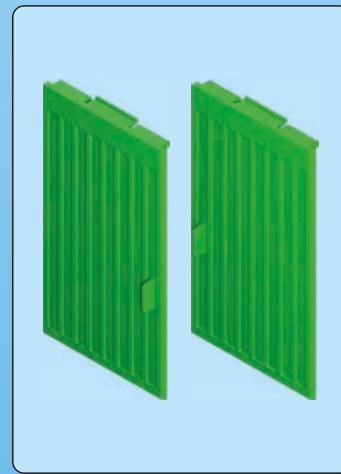

30 51 8542



30 51 8740

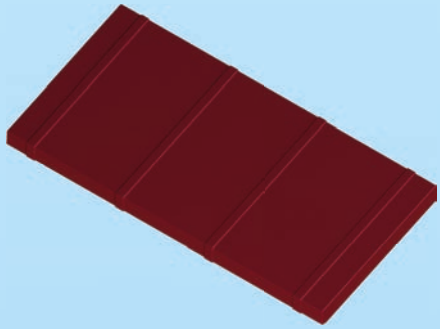

30 09 3802

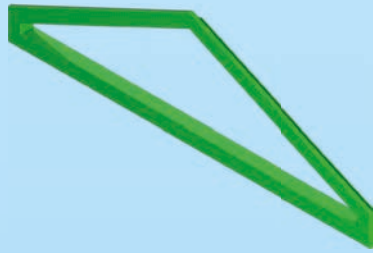

30 09 3862



30 09 3922



30 66 8180



30 66 9280



30 09 3952



30 09 3992



30 03 3093



2x 30 03 3083



30 03 3013

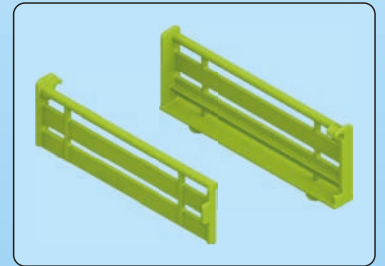

30 60 9092



30 03 3183

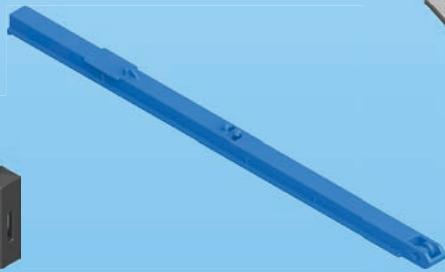

30 03 3063

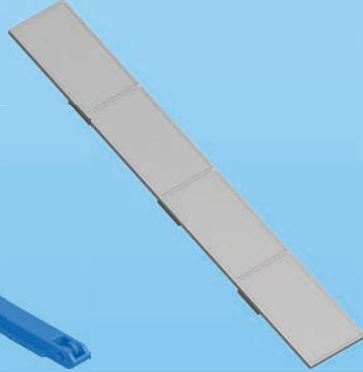

2x 30 09 3972



30 09 3822

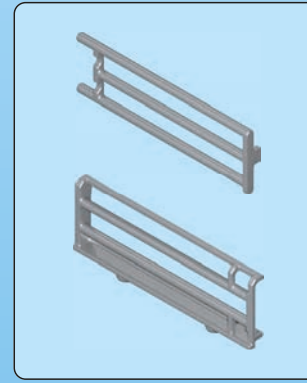

30 60 1102

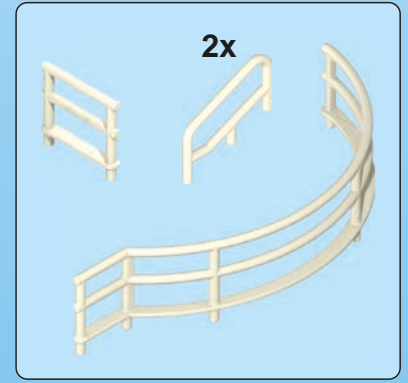

30 51 8572



3x 30 03 3173



30 03 3193

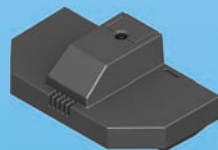

30 67 8873

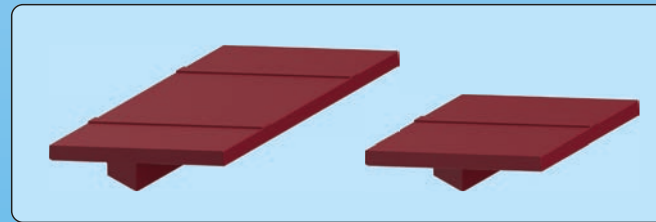

30 60 9082

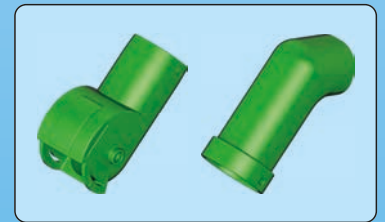

30 60 9132

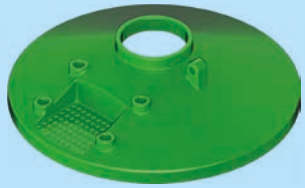

30 03 3303



30 04 5340



30 73 8053



3x 30 09 3912



30 66 1200



30 03 3053

30 06 5430



30 06 5420



30 03 3313



30 23 3600



30 25 9003

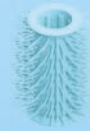

30 28 3600



30 03 3133

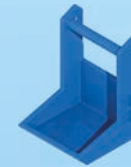

30 03 3203



30 09 7030



30 03 3103

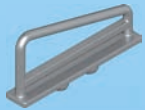

30 22 2912



3x 30 21 1540



3x 30 24 5450

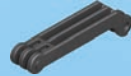

30 03 3113



30 03 3033



30 03 3213



30 03 3073



30 88 4632



30 06 5942



3x 30 09 3982



4x 30 03 3153



2x 30 03 3163



30 29 0990



30 23 6150



30 09 3902



30 60 9102



3x 30 66 1190



2x 30 22 0713



2x 30 22 2812



30 24 9800



30 65 0454



30 64 9515



30 63 9854



30 03 4770

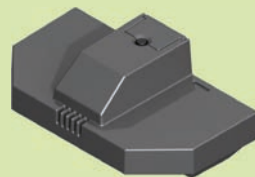
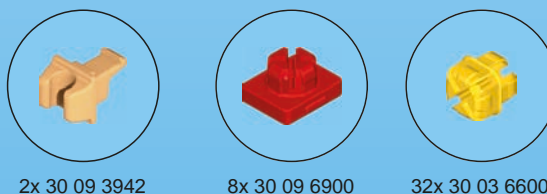

DE AT CH LU BE Denken Sie an den Schutz der Umwelt !

- Ihr Gerät enthält wertvolle Rohstoffe, die wieder verwertet werden können.
- Geben Sie Ihr Gerät deshalb bitte bei einer Sammelstelle Ihrer Stadt oder Gemeinde ab.

GB MT IE Environment protection first !

- Your appliance contains valuable materials which can be recovered or recycled.
- Leave it at a local civic waste collection point.

FR LU CH Participons à la protection de l'environnement !

- Votre appareil contient de nombreux matériaux valorisables ou recyclables.
- Confiez celui-ci dans un point de collecte pour que son traitement soit effectué.

ES ¡¡ Participe en la conservación del medio ambiente !!

- Su electrodoméstico contiene materiales recuperables y/o reciclables.
- Entréguelo al final de su vida útil, en un Centro de Recogida Específico o en uno de nuestros Servicios Oficiales Post Venta donde será tratado de forma adecuada.

NL BE Samen het milieu beschermen !

- Uw product bevat meerdere recycleerbare materialen
- Breng deze naar een afval-inzamelpunt.

BE Participons à la protection de l'environnement !

- Votre appareil contient de nombreux matériaux valorisables ou recyclables.
- Confiez celui-ci dans un point de collecte ou à défaut dans un centre service agréé pour que son traitement soit effectué.

IT CH Partecipiamo alla protezione dell'ambiente !

- Il vostro apparecchio è composto da diversi materiali che possono essere riciclati.
- Lasciatelo in un punto di raccolta o presso un Centro Assistenza Autorizzato.

PT Protecção do ambiente em primeiro lugar!

- O seu produto contém materiais que podem ser recuperados ou reciclados.
- Entregue-o num ponto de recolha para possibilitar o seu tratamento.

DK Vi skal alle være med til at beskytte miljøet!

- Apparatet indeholder mange materialer, der kan genvindes eller genbruges.
- Bring det til et specialiseret indsamlingssted for genbrug eller et autoriseret serviceværksted, når det ikke skal bruges mere.

SE FI Var rädd om miljön!

- Din apparat innehåller olika material som kan återanvändas eller återvinnas.
- Lämna den på en återvinningsstation eller på en auktoriserad serviceverkstad för omhändertagande och behandling.

FI Huolehtikaamme ympäristöstä!

- i Laitteesi on varustettu monilla arvokkailla ja kierrätettävillä materiaaleilla.
- Toimita laitteesi keräyspisteeseen tai sellaiseen puuttuessa vaikka valtuutettuun huoltokekkukseen, jotta laitteen osat varmasti kierrätetään.

HU Első a környezetvédelem!

- Az Ön terméke értékes újrahaznosítható anyagokat tartalmaz.
- Kérjük készülékét ne dobja ki, hanem adja le az erre célra kijelölt gyűjtőhelyen.

CZ Podílejme se na ochraně životního prostředí!

- Váš přístroj obsahuje cenné životní nebo recyklovatelné materiály.
- Světe jej sběrnému místu nebo, neexistuje-li, smluvnímu servisnímu středisku, kde s ním bude naloženo odpovídajícím způsobem.

SI Sodelujmo pri varovanju okolja!

- Vaš aparat vsebuje številne dele, ki imajo svojo vrednost ali jih je še mogoče uporabiti.
- Oddajte ga na mestu za zbiranje odpadkov ali pa na pooblaščenem servisu, da bo šel v predelavo.

SK Podielajme sa na ochrane životného prostredia!

- Váš prístroj obsahuje cenné životné alebo recyklovateľné materiály.
- Zverte ho sbornému miestu alebo, ak neexistuje, zmluvnému servisnému stredisku, kde s ním bude naložené zodpovedajúcim spôsobom.

PL Bierzmy czynny udział w ochronie środowiska!

- Twoje urządzenie jest zbudowane z materiałów, które mogą być poddane ponownemu przetworzeniu lub recyklingowi.
- W tym celu należy je dostarczyć do wyznaczonego punktu zbiórki.

GR CY Ας συμβάλλουμε κι εμείς στην προστασία του περιβάλλοντος!

- Η συσκευή σας περιέχει πολλά αξιοποιήσιμα ή ανακυκλώσιμα υλικά.
- Παραδώστε την παλιά συσκευή σας σε κέντρο διαλογής ή σε ένα εξουσιοδοτημένο κατάστημα σέρβις.

RO Țineți cont de protecția mediului !

- Aparatul dvs. conține materii prime valoroase care pot fi revalorificate.
- Din acest motiv vă rugăm să predați aparatul dvs. la un centru de colectare din orașul sau comuna dvs.

BG Мислете за околната среда !

- Вашият уред съдържа ценни суровини, които могат да бъдат рециклирани.
- Затова върнете своя електроуред на специално място за събиране на такива отпадъци във Вашия град или община.

US

NOTE: This equipment has been tested and found to comply with the limits for a Class B digital device, pursuant to part 15 of the FCC Rules. These limits are designed to provide reasonable protection against harmful interference in a residential installation. This equipment generates, uses and can radiate radio frequency energy and, if not installed and used in accordance with the instructions, may cause harmful interference to radio communications. However, there is no guarantee that interference will not occur in a particular installation. If this equipment does cause harmful interference to radio or television reception, which can be determined by turning the equipment off and on, the user is encouraged to try to correct the interference by one or more of the following measures:

- Reorient or relocate the receiving antenna.
- Increase the separation between the equipment and receiver.
- Connect the equipment into an outlet on a circuit different from that to which the receiver is connected.
- Consult the dealer or an experienced radio/TV technician for help.

PLAYMOBIL USA, INC.

26 Commerce Drive
Cranbury, NJ 08512
Phone 1-800-752-9662 or 609-395-5566
Email: service@playmobilusa.com

Caution: Changes or modifications not expressly approved by the party responsible for compliance could void the user's authority to operate the equipment.

US

This device complies with Part 15 of the FCC Rules. Operation is subject to the following two conditions:
(1) This device may not cause harmful interference, and
(2) this device must accept any interference received, including interference that may cause undesired operation.

CA CAN ICES-3 (B)/NMB-3(B)

Cet équipement est conforme à la Section 15 des règlements de la FCC. Son fonctionnement est soumis aux deux conditions suivantes:
(1) Cet équipement ne peut causer d'interférence nuisible, et
(2) cet équipement doit pouvoir fonctionner même s'il capte de l'interférence, incluant celle pouvant provoquer un fonctionnement indésirable.

Serviceadressen finden Sie in allen PLAYMOBIL-Prospekten

Addresses of Customer Service Departments are shown in all PLAYMOBIL catalogues

L'adresse du service consommateurs est indiquée dans tous les catalogues PLAYMOBIL

Troverete gli indirizzi dei centri di assistenza in tutti i cataloghi PLAYMOBIL

In alle PLAYMOBIL catalogi vindt u het adres van onze klantendienst.
Las Direcciones de los Departamentos de Servicio al Consumidor se encuentran en todos los catálogos PLAYMOBIL

Η διεύθυνση του Γραφείου Εξυπηρέτησης καταναλωτών PLAYMOBIL βρίσκεται σε όλους τους καταλόγους PLAYMOBIL.

pronounced: plāy-mō-bēel

