

Wichtige Unterlagen, bitte sorgfältig aufbewahren!
Important: Please keep these instructions for future reference!
Documents importants, à conserver soigneusement!
Belangrijke documenten, bewaar deze zorgvuldig!



WARNING: CHOKING HAZARD

Contains a small ball and small parts.
Not for children under 3 years.

“Ne concerne que les USA“



1

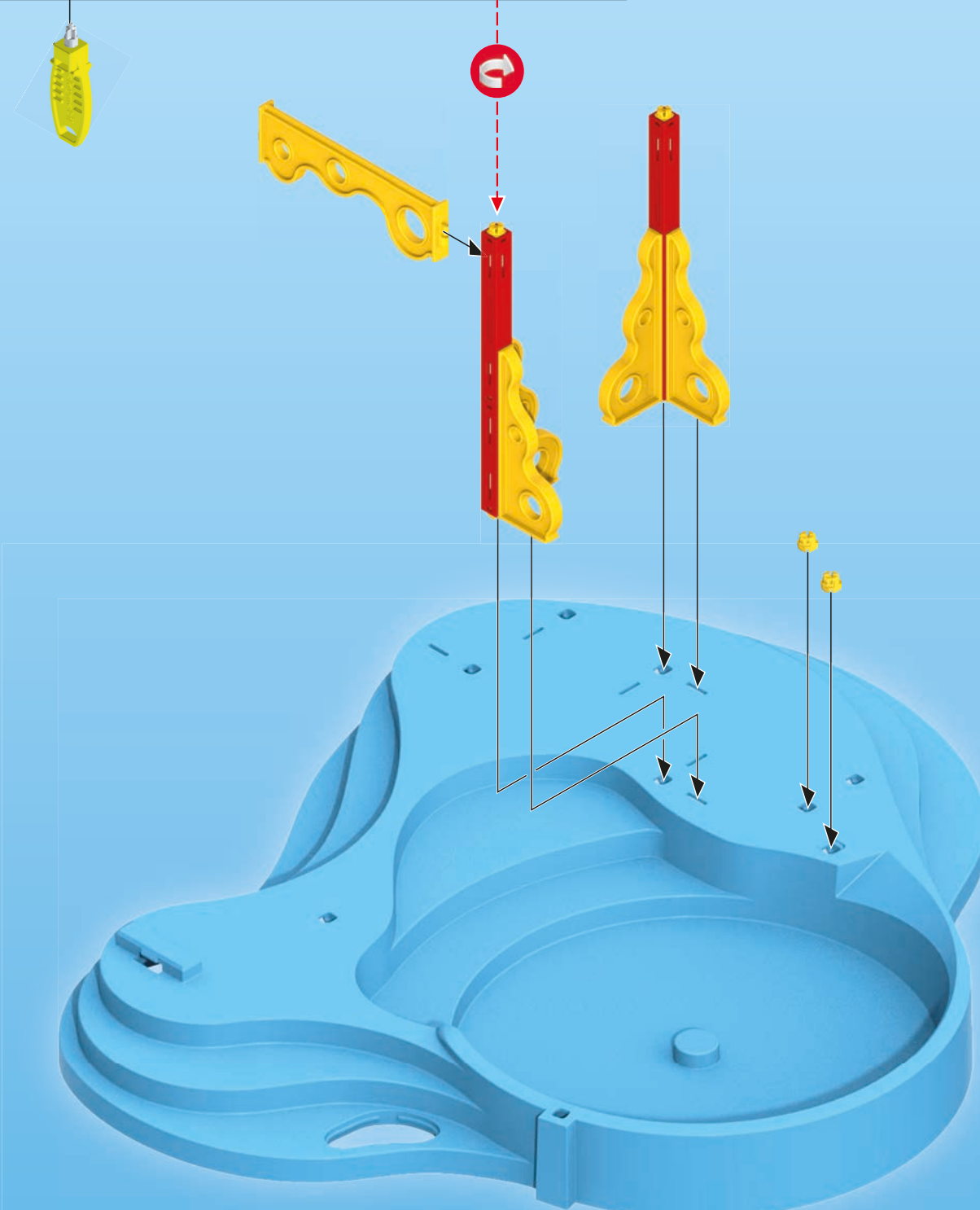
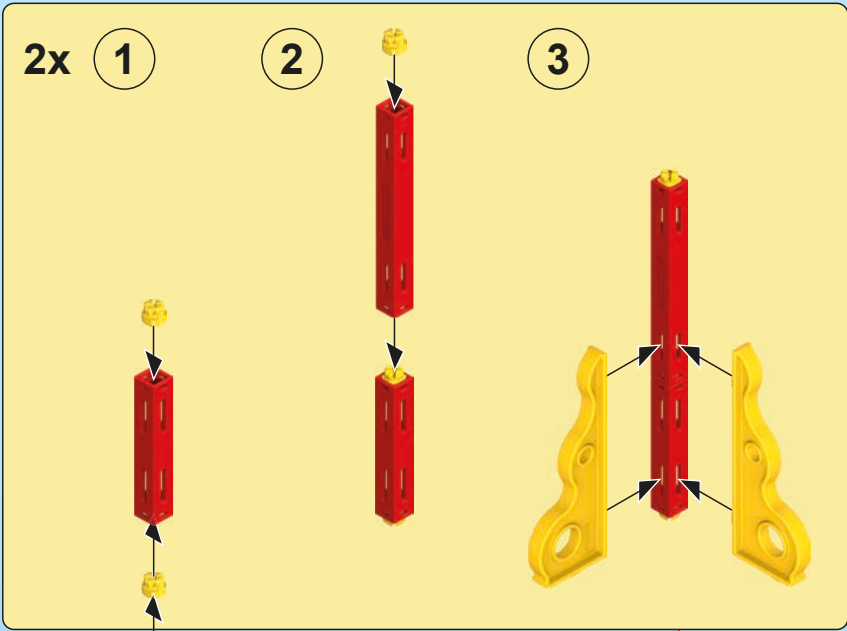

2

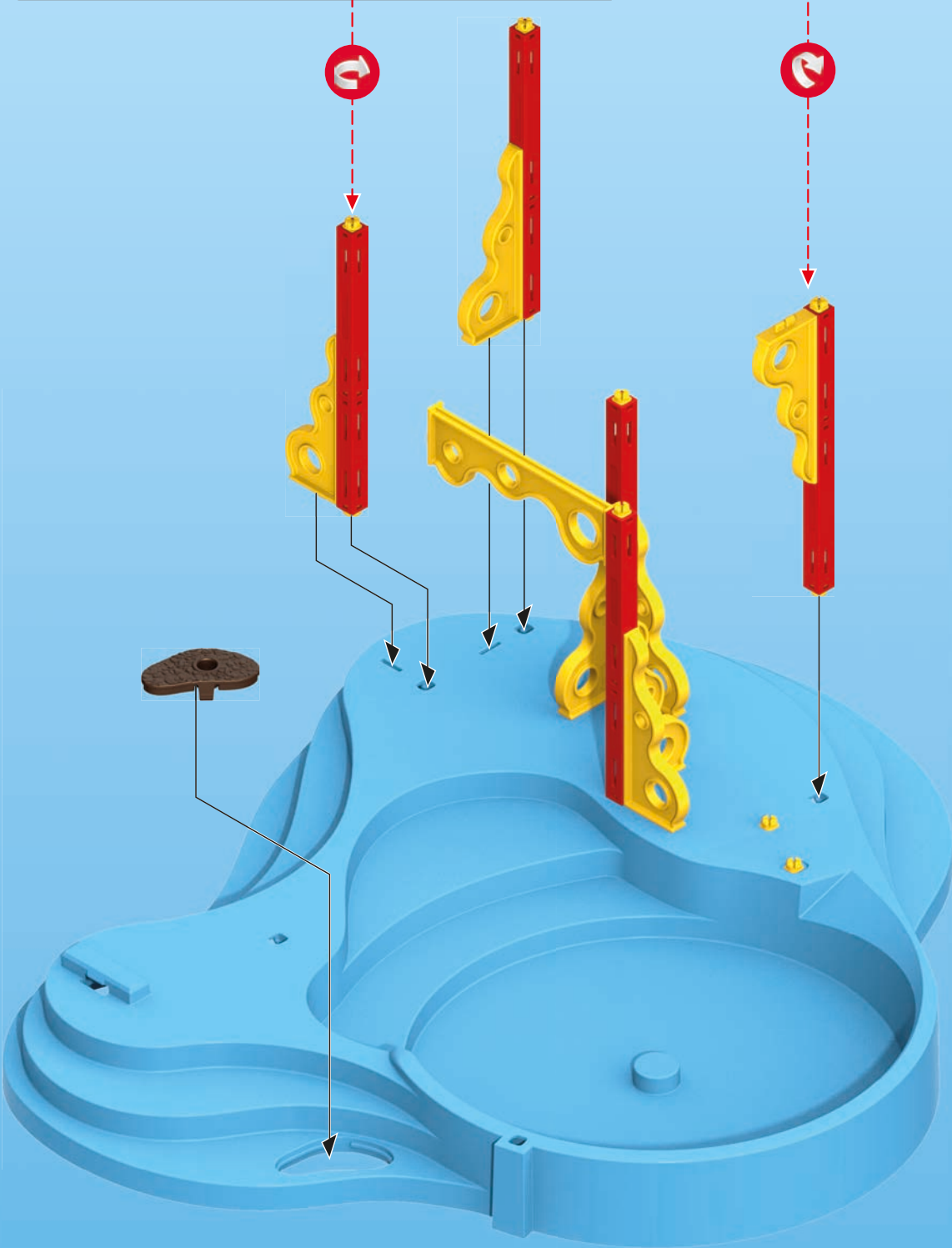
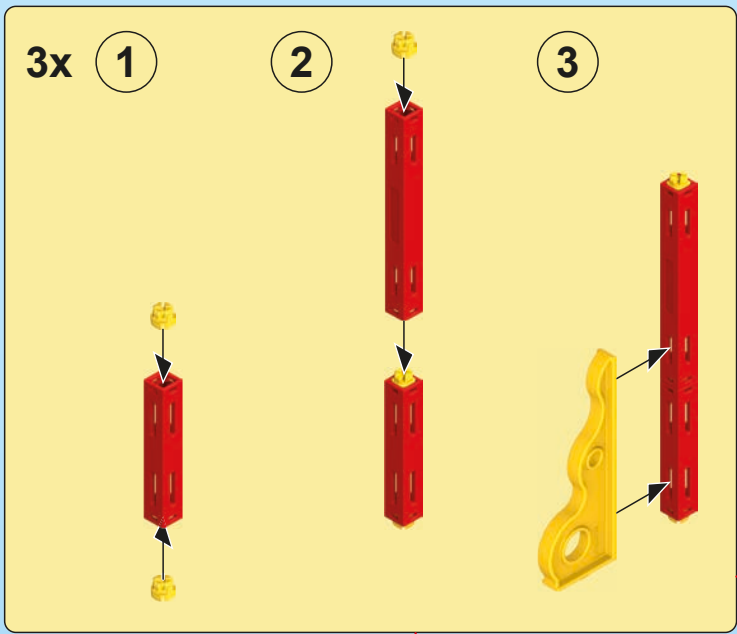

3

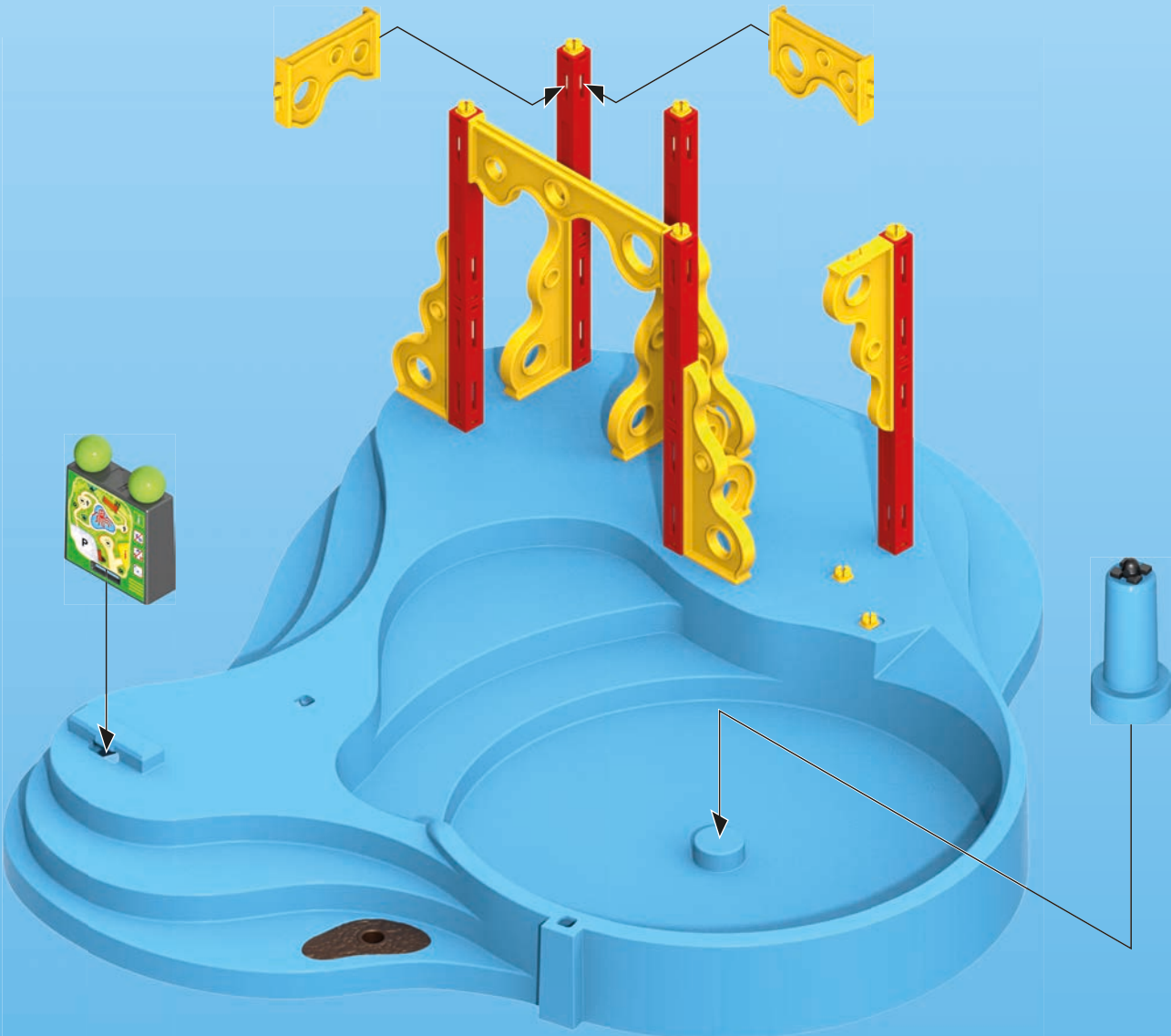
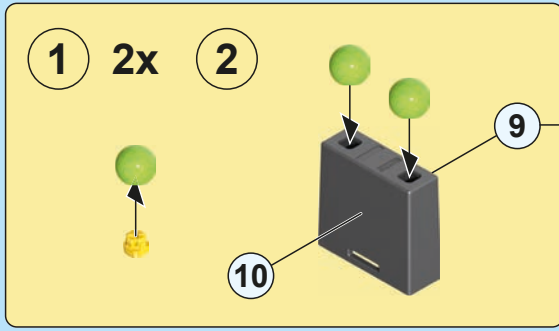
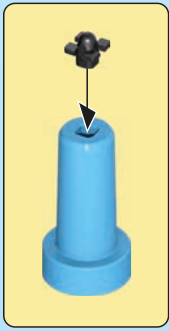

4

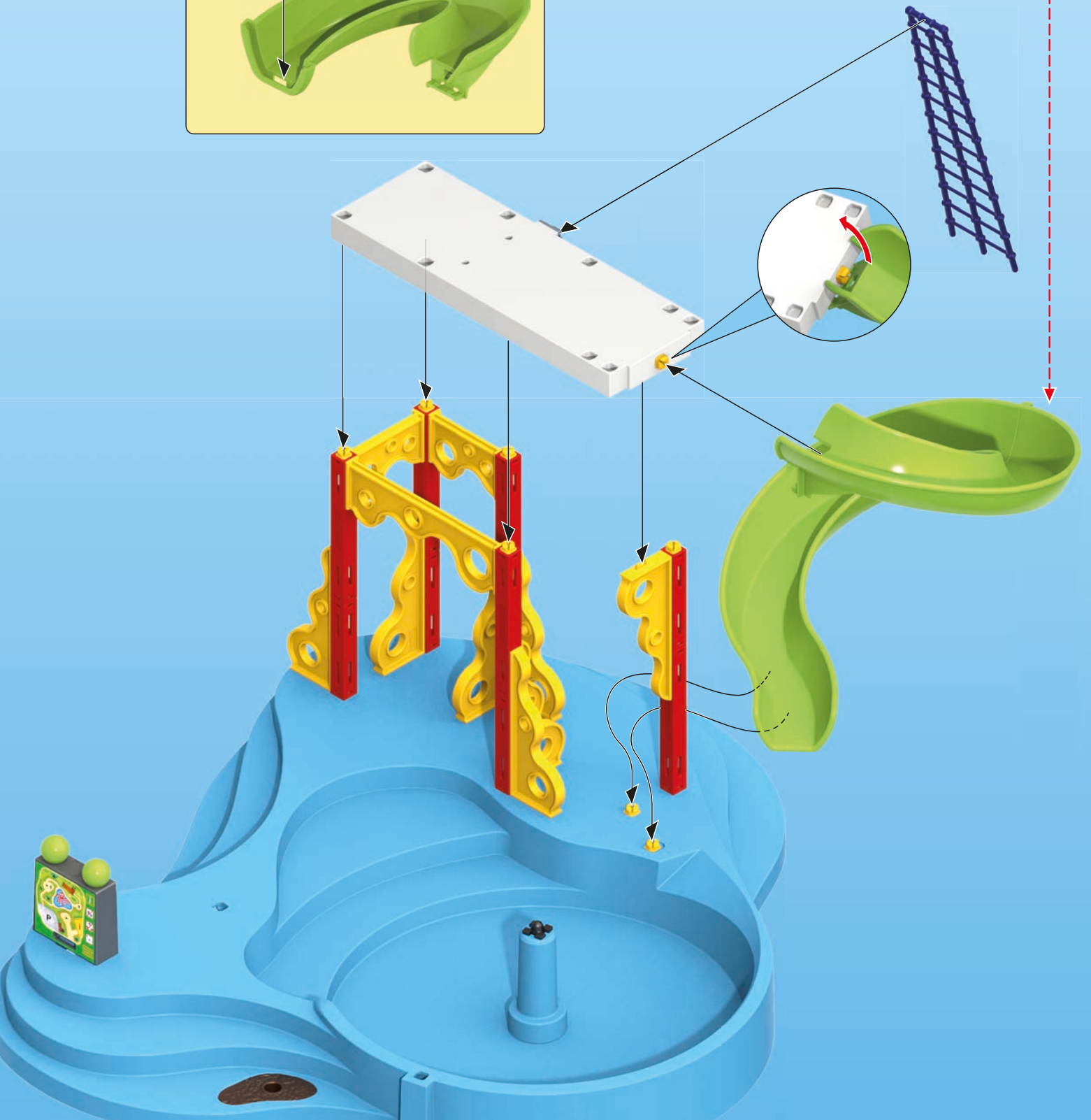
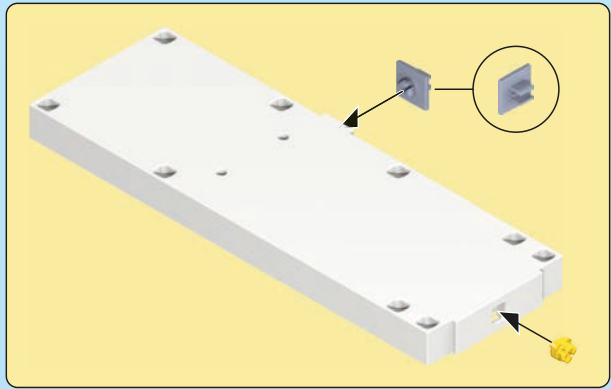

5

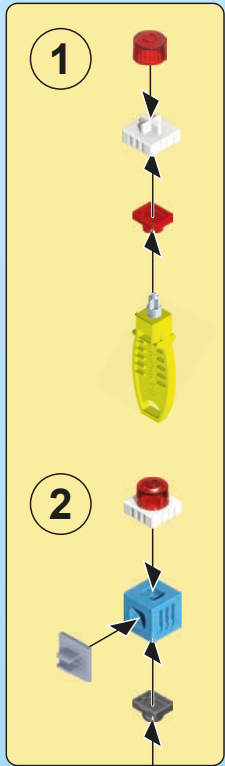
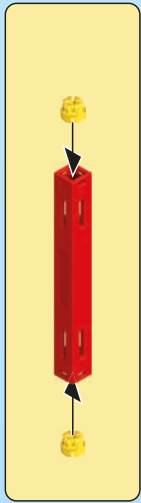
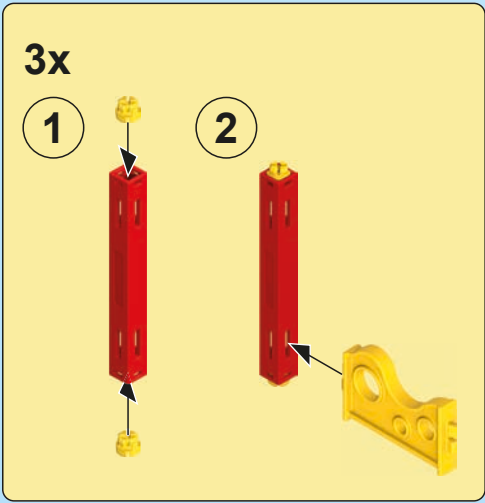

6

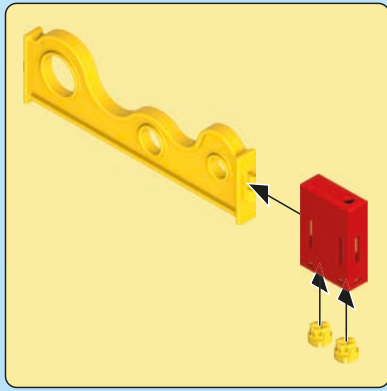
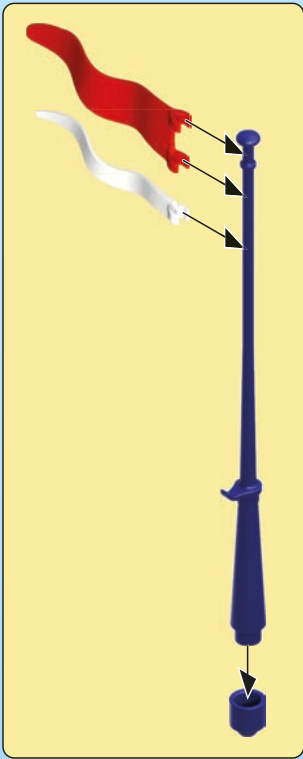

7

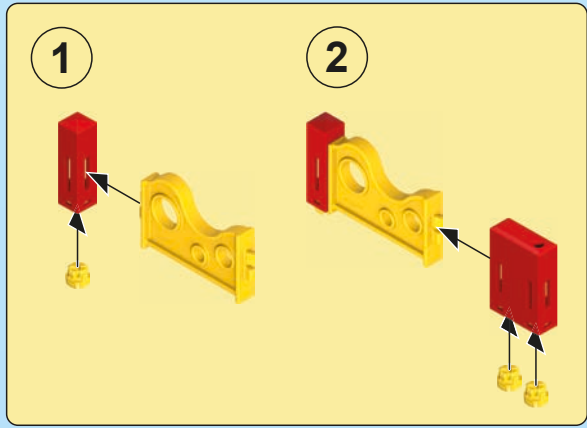
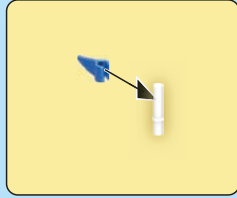
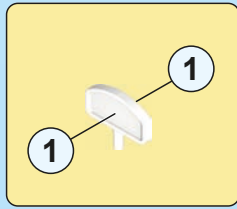

8

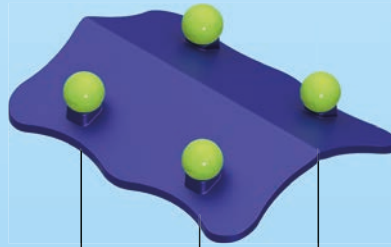
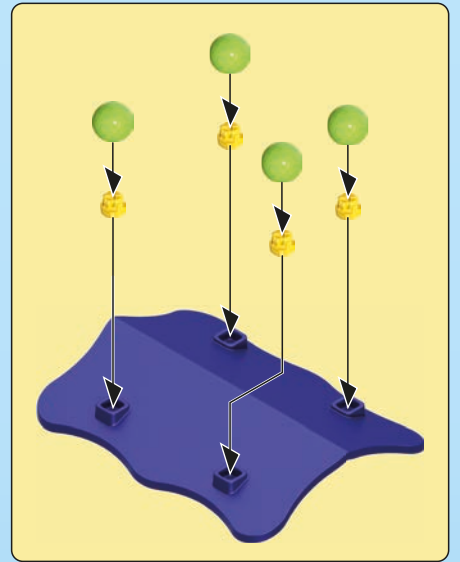

DE AT CH LU BE Nur Trinkwasser verwenden. Nach dem Spielen austrocknen lassen.

US GB CA MT IE Use only tap water. Dry thoroughly after play.

FR CA BE LU CH N'utiliser que de l'eau potable. Faire sécher après chaque utilisation.

ES MX Utilizar solamente agua potable. Dejar secar antes de guardar.

NL BE Enkel drinkbaar water gebruiken. Na het spelen laten drogen.

IT CH Usare solo acqua potabile. Asciugare bene dopo ogni uso.

PT Utilizar somente água potável. Deixar secar antes de guardar.

DK Anvend kun drikkevand. Lad det tørre ud når du er færdig med at lege.

NO Kun drikkevann skal benyttes. Tørk opp etter at leken er ferdig.

SE FI Använd endast dricksvatten. Låt torka efter användandet.

FI Käytä ainoastaan juomavettä. Anna kuivua leikin jälkeen.

HU Kérjük kizárólag ivóvizet használjon! Játék után ajánlott a termék kiszáritása!

CZ Používat jen pitnou vodu. Po hraní nechat vyschnout.

EE Kasutada üksnes joogivett! Mängimise järel kuivatada!

LV Izmantot tikai dzeramo ūdeni. Pēc spēlēšanās ļaut nožūt.

LT Naudokite tik geriamąjį vandenį. Pažaidus, išdžiovinkite.

SI V igračo vlivajte le pitno vodo. Po igri naj se igrača posuši.

SK Používať iba pitnú vodu. Po hre nechať vyschnúť.

PL Używać tylko wodę pitną. Po zabawie pozostaw do wyschnięcia.

TR CY Sadece içme suyu kullanınız. Oyundan sonra kurumaya bırakın.

GR CY Χρησιμοποιείτε μόνο νερό βρύσης. Μόλις τελειώσετε, αφήστε το παιχνίδι να στεγνώσει εντελώς.

RO Se folosește doar apă potabilă. După joacă se lasă să se usuce.

BG Използвайте само питейна вода. След игра оставете да изсъхне.

HR Koristiti samo pitku vodu. Poslije igranja pustiti da se osuši.

CN 仅使用饮用水。玩耍后要干燥。



1

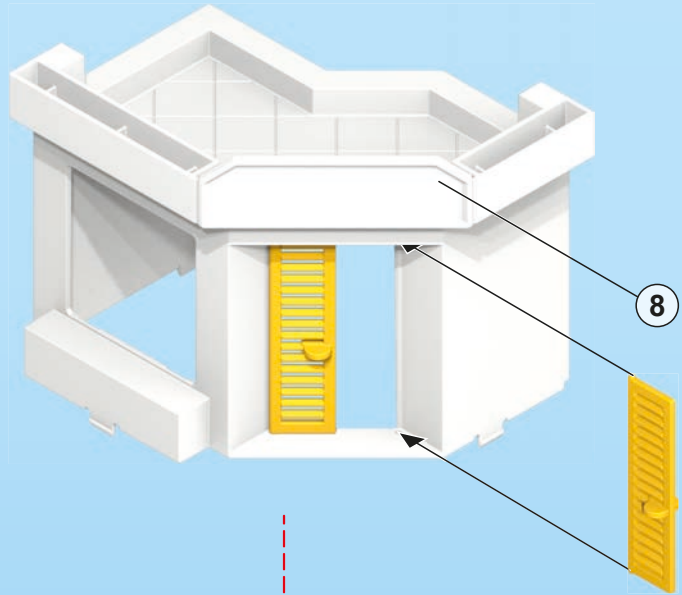

2

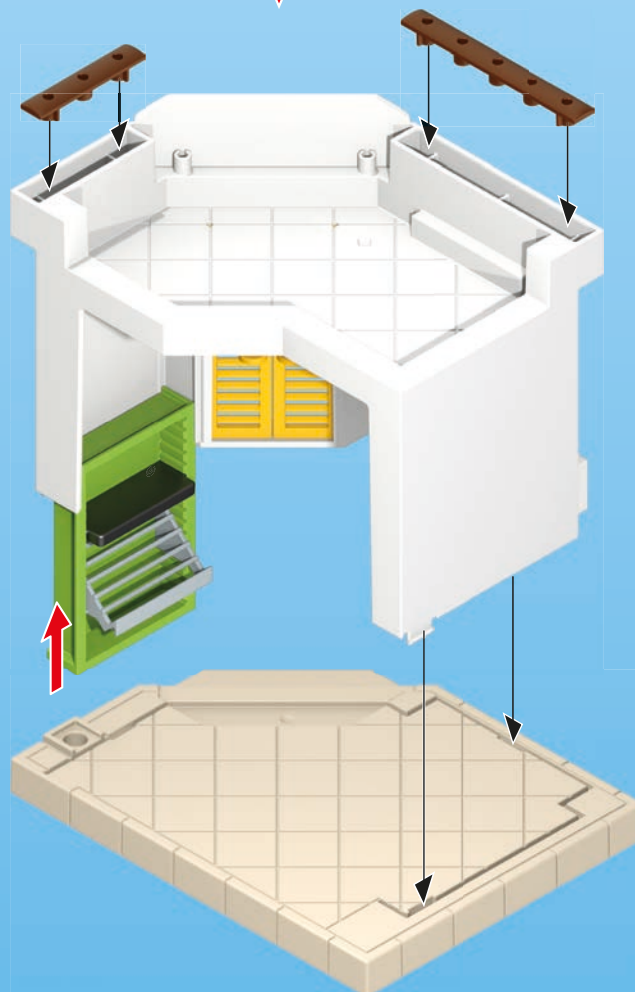
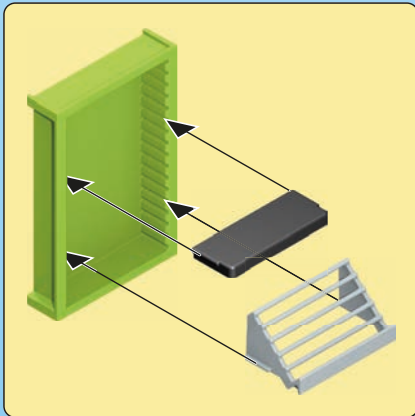

3

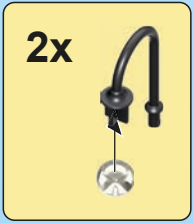
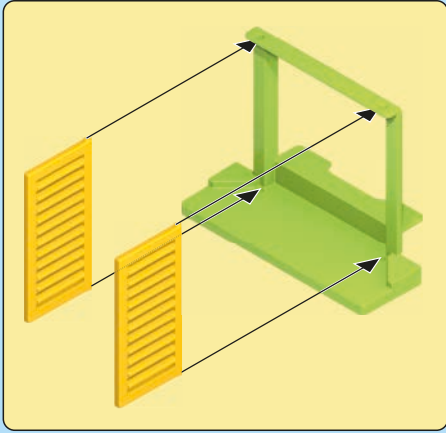

4

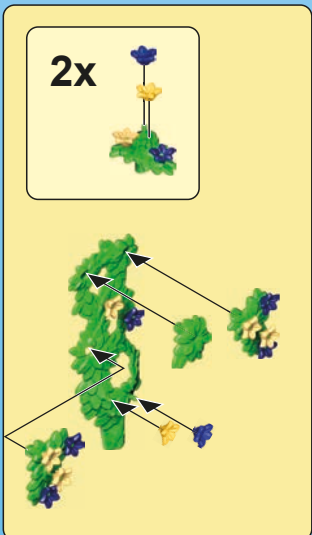
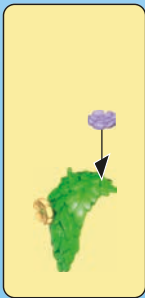
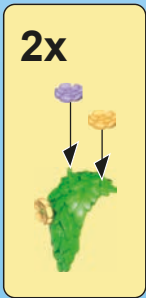
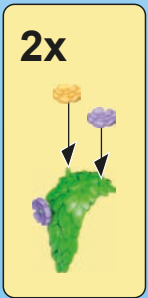

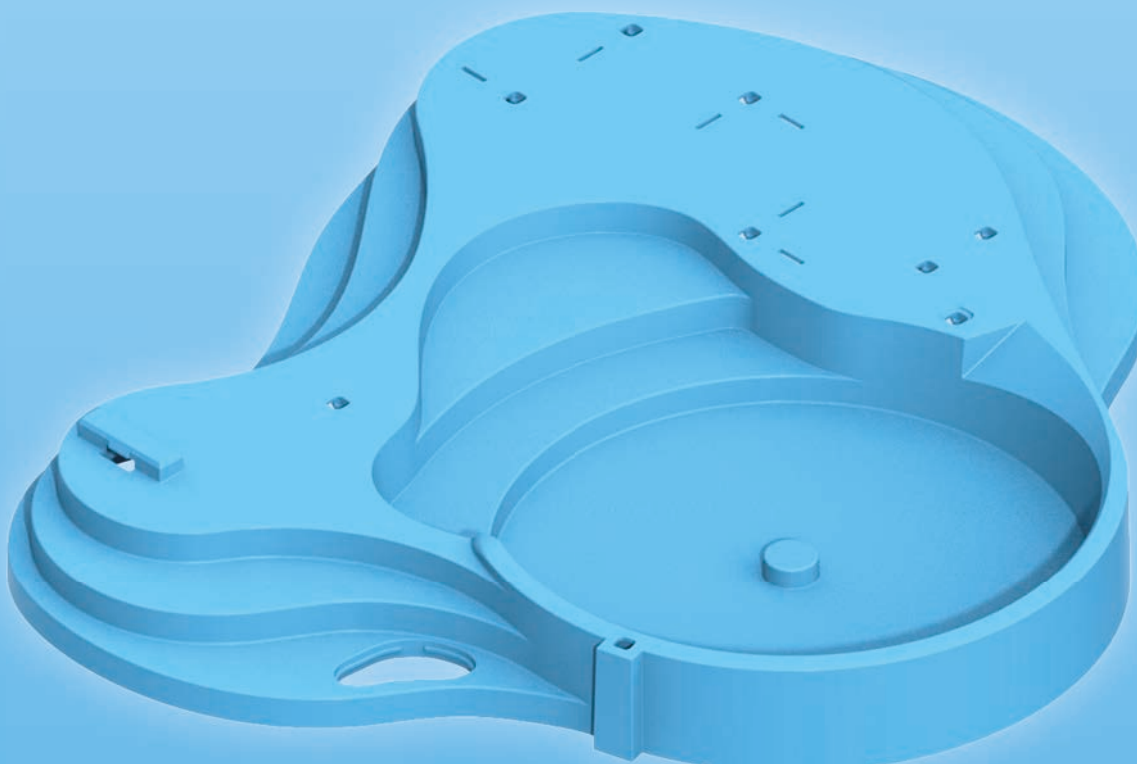
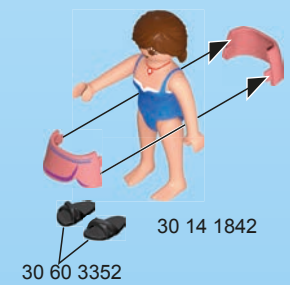
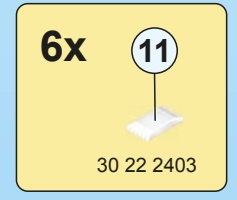
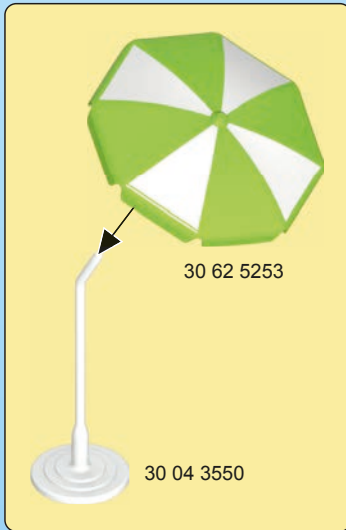
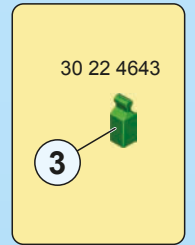
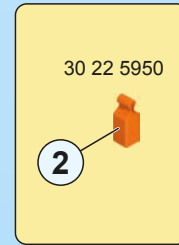
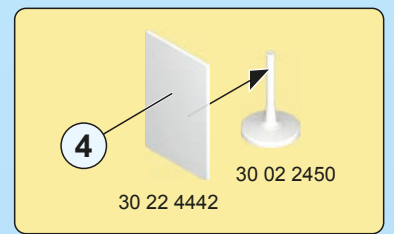
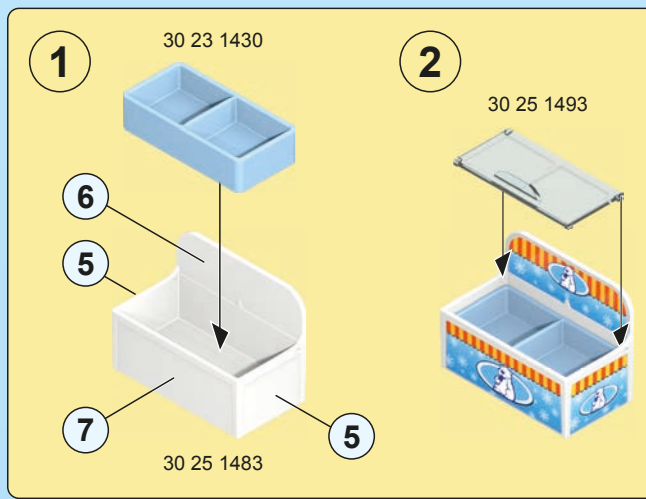

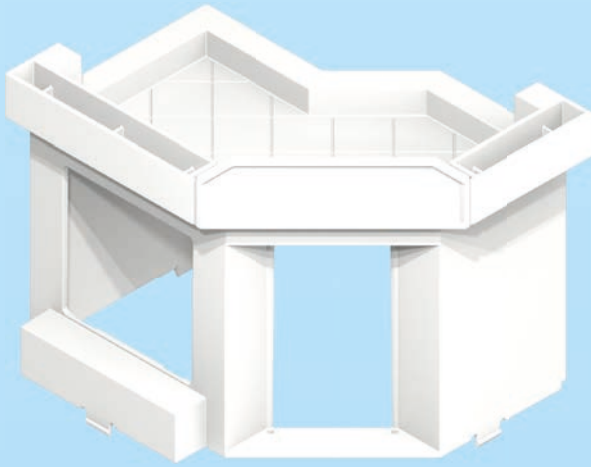

30 25 1593

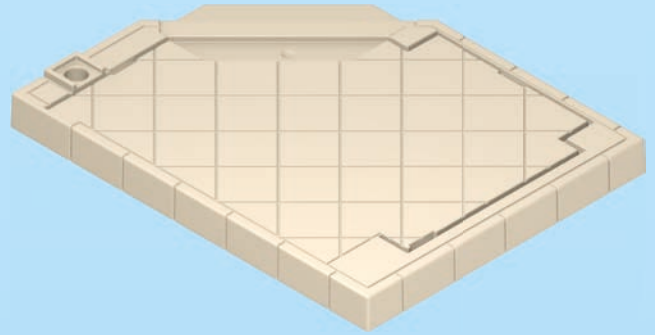

30 22 4872



30 23 5573



30 23 5403

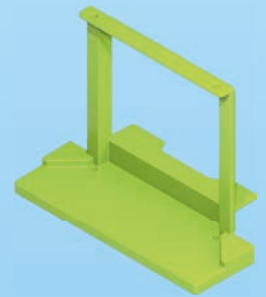

30 22 4832



30 21 9230



30 21 9240



30 03 3583



30 82 1555



30 25 9280



30 51 8602



30 03 3643



30 28 8830



2x 30 03 3693



7x 30 03 3703



30 64 9605



9x 30 03 3653



5x 30 03 3663



30 03 3673



2x 30 03 3683



30 23 5493



6x 30 03 3713



30 03 1280



30 24 8370



30 04 4720



2x 30 03 3573



30 03 3603



30 27 8240



30 64 0214



30 65 8822



30 51 8592



30 60 1192



30 23 5383



5x 30 21 4422

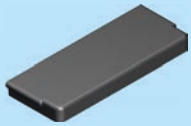

30 05 5612



2x 30 22 4802



30 27 6980



30 23 5333



30 23 5313



4x 30 04 2760



2x 30 03 2920



30 21 3852



30 03 3623



30 20 0290



3x 30 24 2833



2x 30 25 1563



6x 30 03 3613



30 02 1220



30 23 5800



2x 30 23 5303



30 25 7980



30 27 5820



7x 30 25 1280



7x 30 25 3100



6x 30 21 9273



6x 30 25 2830



30 20 0200



30 09 6900

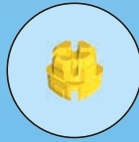

37x 30 03 6600

Serviceadressen finden Sie in allen Playmobil-Prospekten

Addresses of Customer Service Departments are shown in all Playmobil catalogues

L'adresse du service consommateurs est indiquée dans tous les catalogues Playmobil

Troverete gli indirizzi dei centri di assistenza in tutti i cataloghi Playmobil

In alle PLAYMOBIL catalogi vindt u het adres van onze klantendienst.

Las Direcciones de los Departamentos de Servicio al Consumidor se encuentran en todos los catálogos Playmobil

Η διεύθυνση του Γραφείου Εξυπηρέτησης Καταναλωτών PLAYMOBIL βρίσκεται σε όλους τους καταλόγους PLAYMOBIL.

pronounce: plāy-mō-bēil



© 2019 geobra Brandstätter Stiftung & Co.KG
 Brandstätterstr. 2-10
 90513 Zirndorf, Germany.
 No. 30 82 2455 07 20

www.playmobil.com

Abbildungen können vom Original abweichen. / Product may differ from image shown.
 Les illustrations peuvent différer de l'original. / Afbeeldingen kunnen verschillen van het werkelijke artikel.