

playmobil®

70087



WARNING: CHOKING HAZARD

Contains a small ball and small parts.
Not for children under 3 years.

"Ne concerne que les USA"

Wichtige Unterlagen, bitte sorgfältig aufbewahren!
Important: Please keep these instructions for future reference!
Documents importants, à conserver soigneusement!
Belangrijke documenten, bewaar deze zorgvuldig!



Serviceadressen finden Sie in allen Playmobil-Prospekten

Addresses of Customer Service Departments are shown in all Playmobil catalogues

L'adresse du service consommateurs est indiquée dans tous les catalogues Playmobil

Troverete gli indirizzi dei centri di assistenza in tutti i cataloghi Playmobil

In alle PLAYMOBIL catalogi vindt u het adres van onze klantendienst.

Las Direcciones de los Departamentos de Servicio al Consumidor se encuentran en todos los catálogos Playmobil

Η διεύθυνση του Γραφείου Εξυπηρέτησης Καταναλωτών PLAYMOBIL βρίσκεται σε όλους τους καταλόγους PLAYMOBIL.

pronounce: plāy-mō-bēēl

1

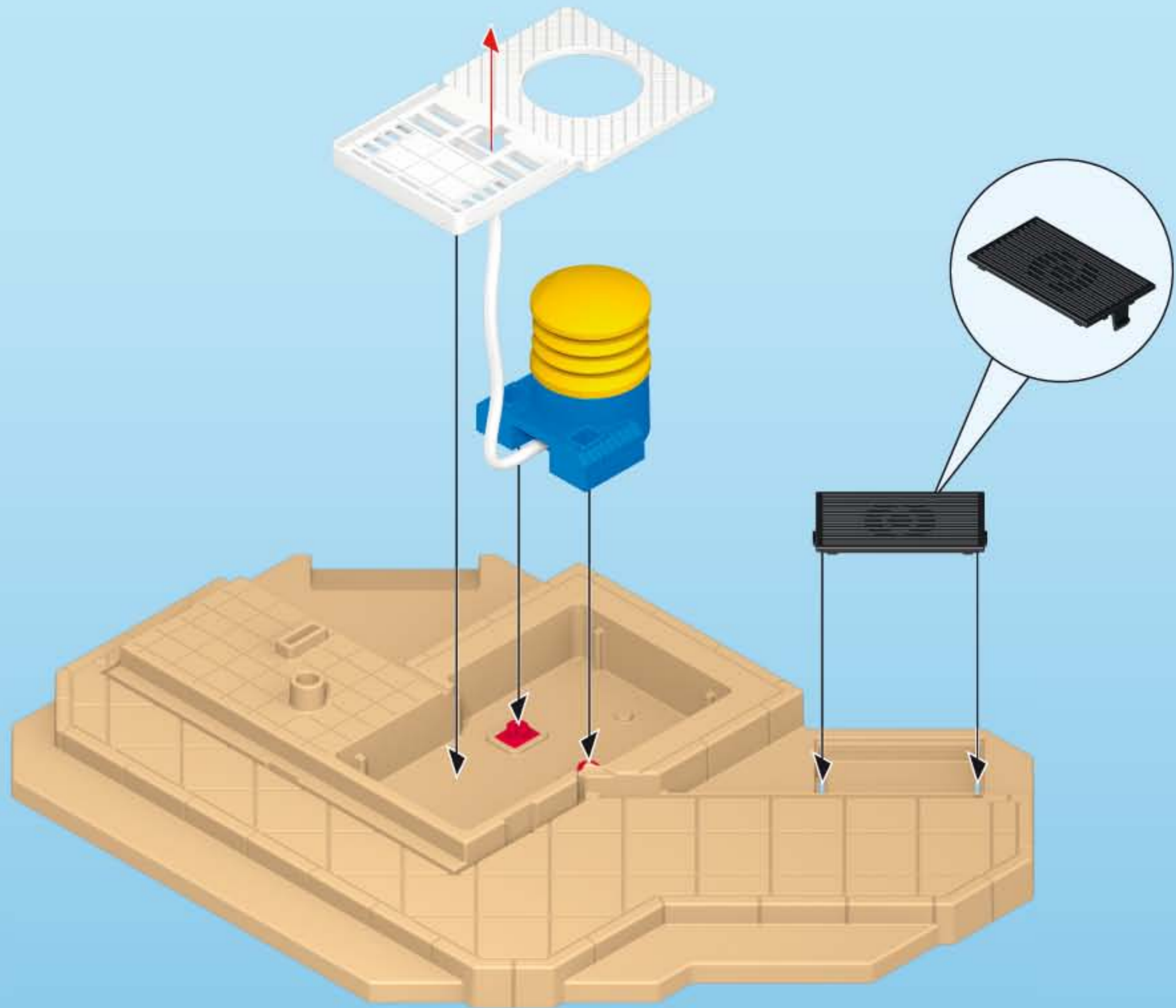
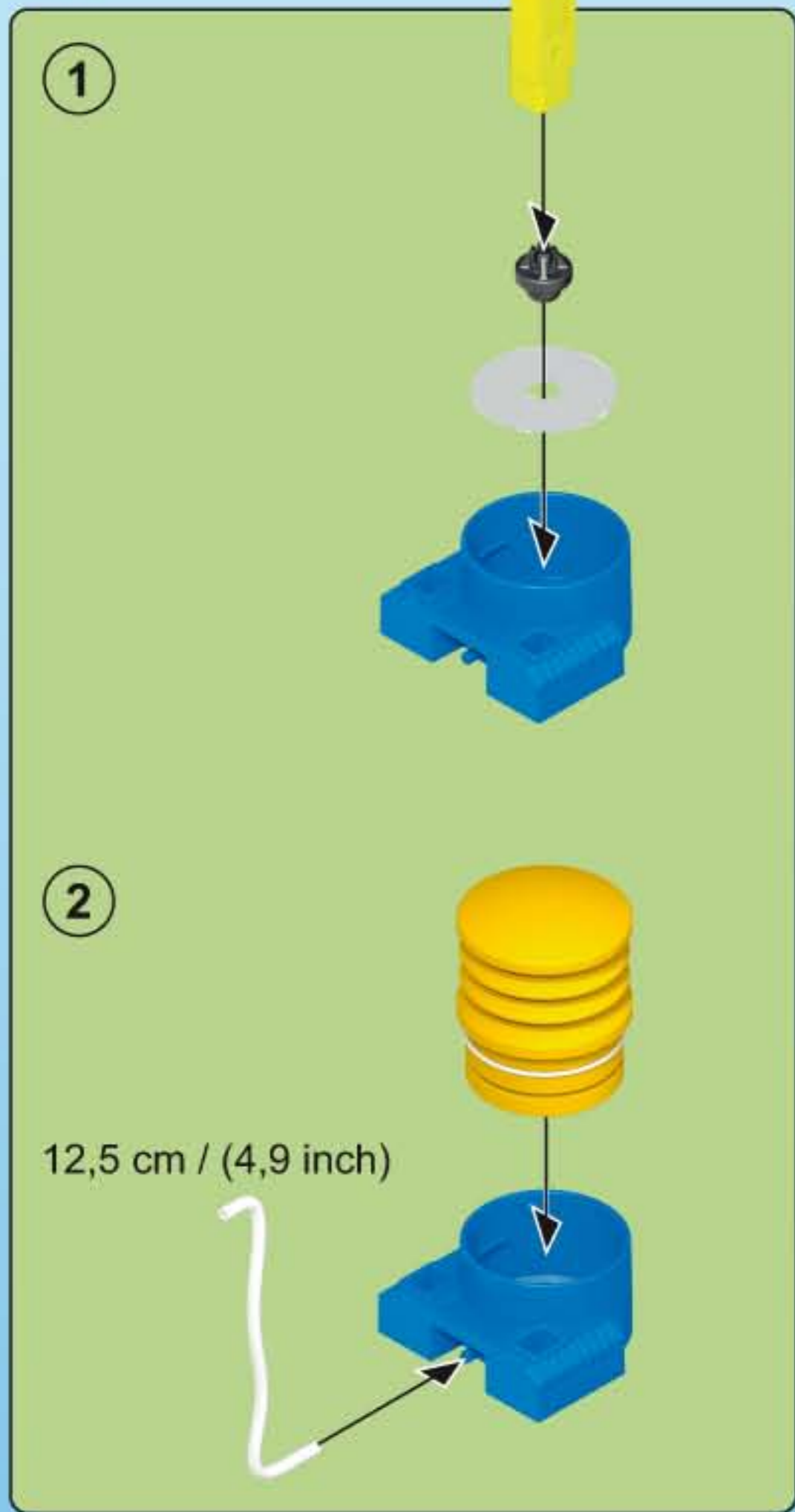

2

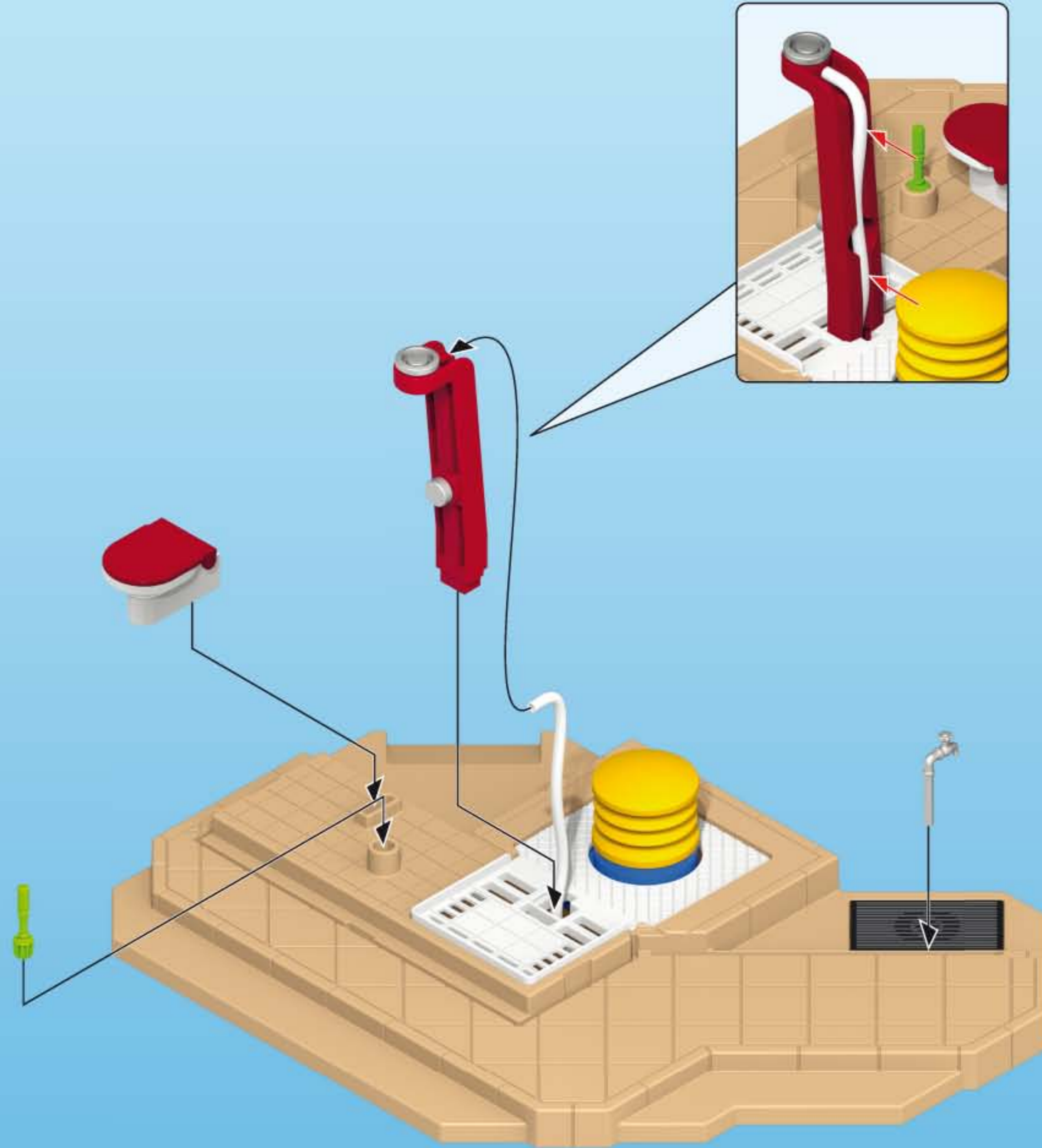

1

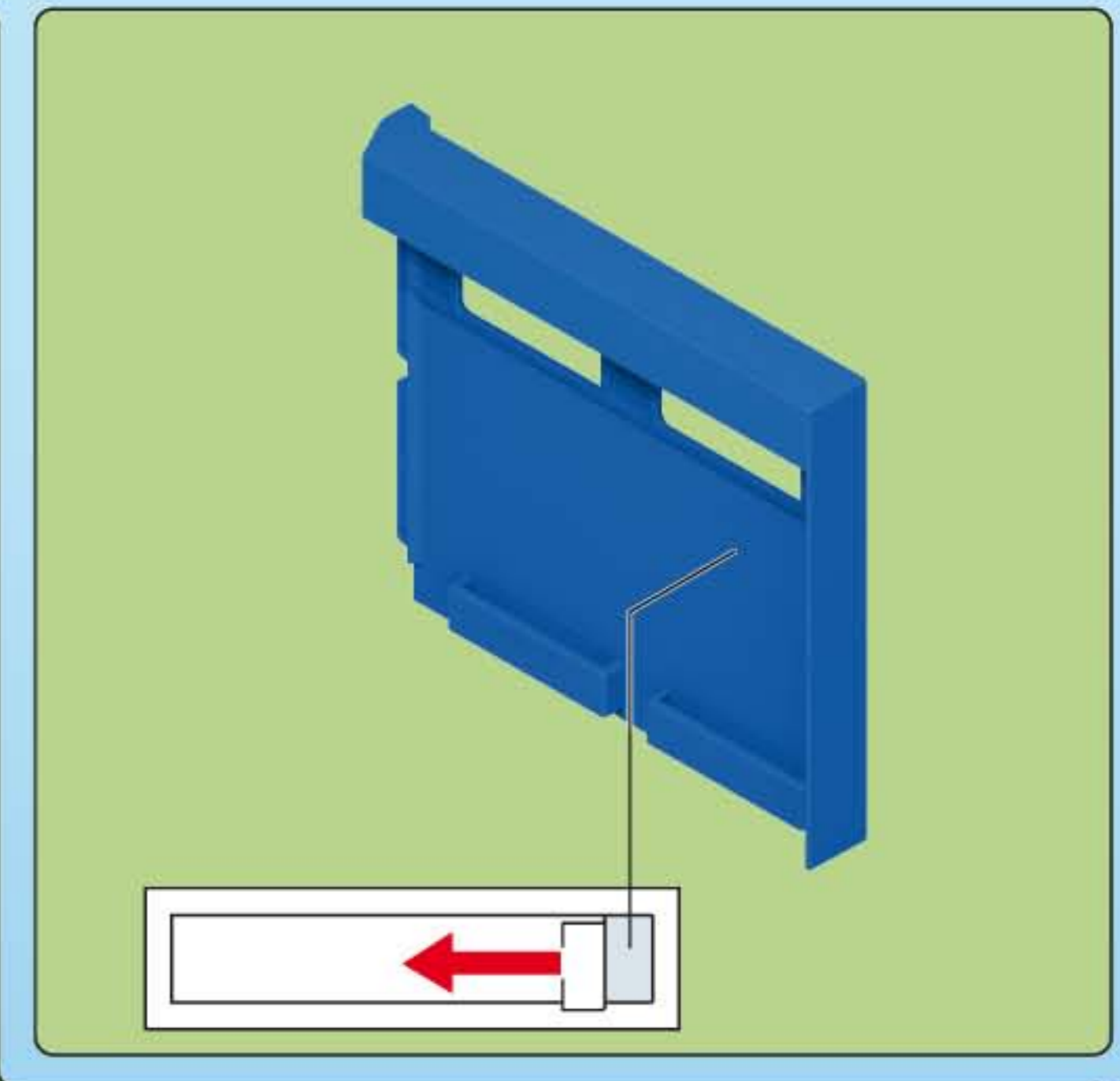
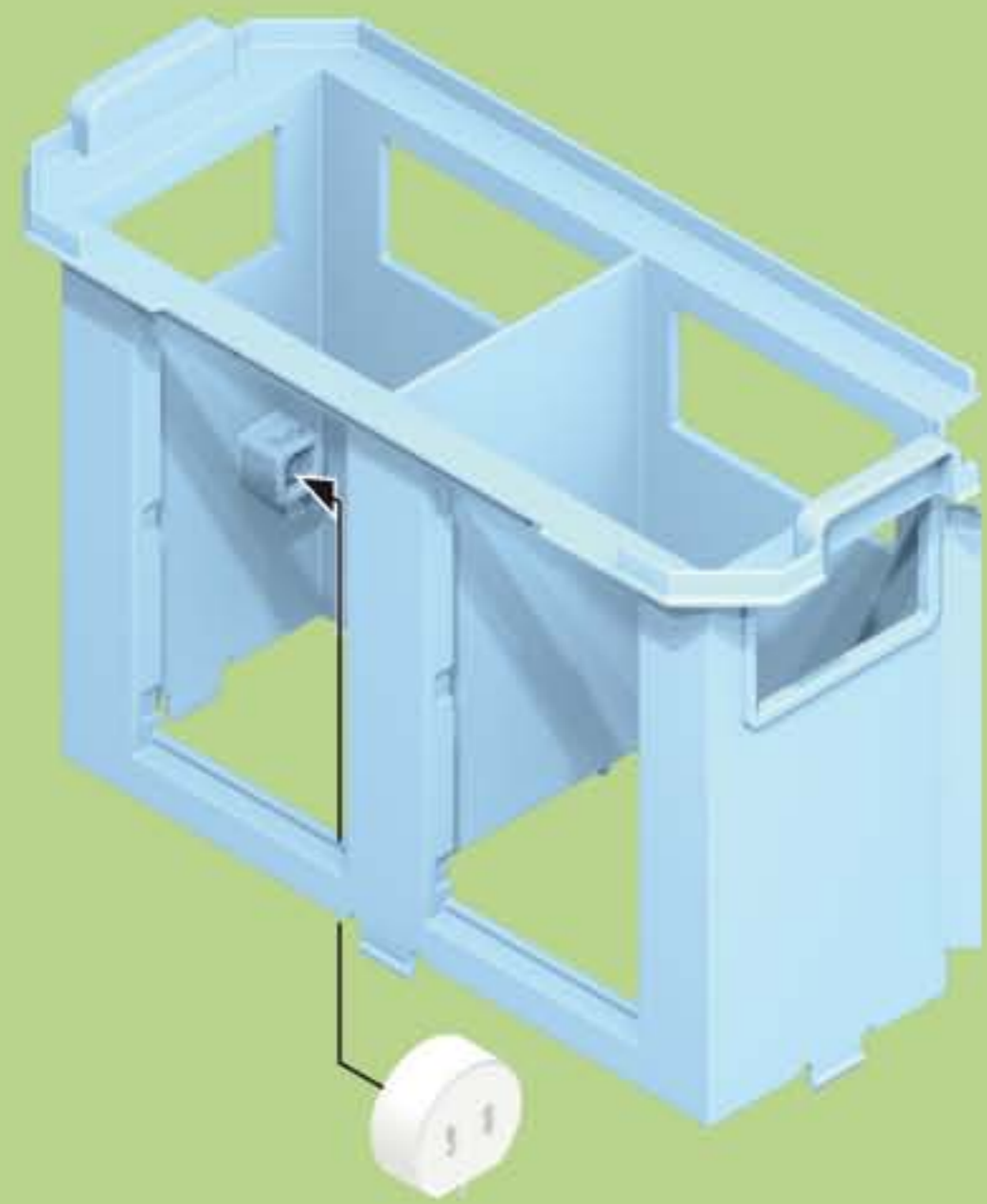

2

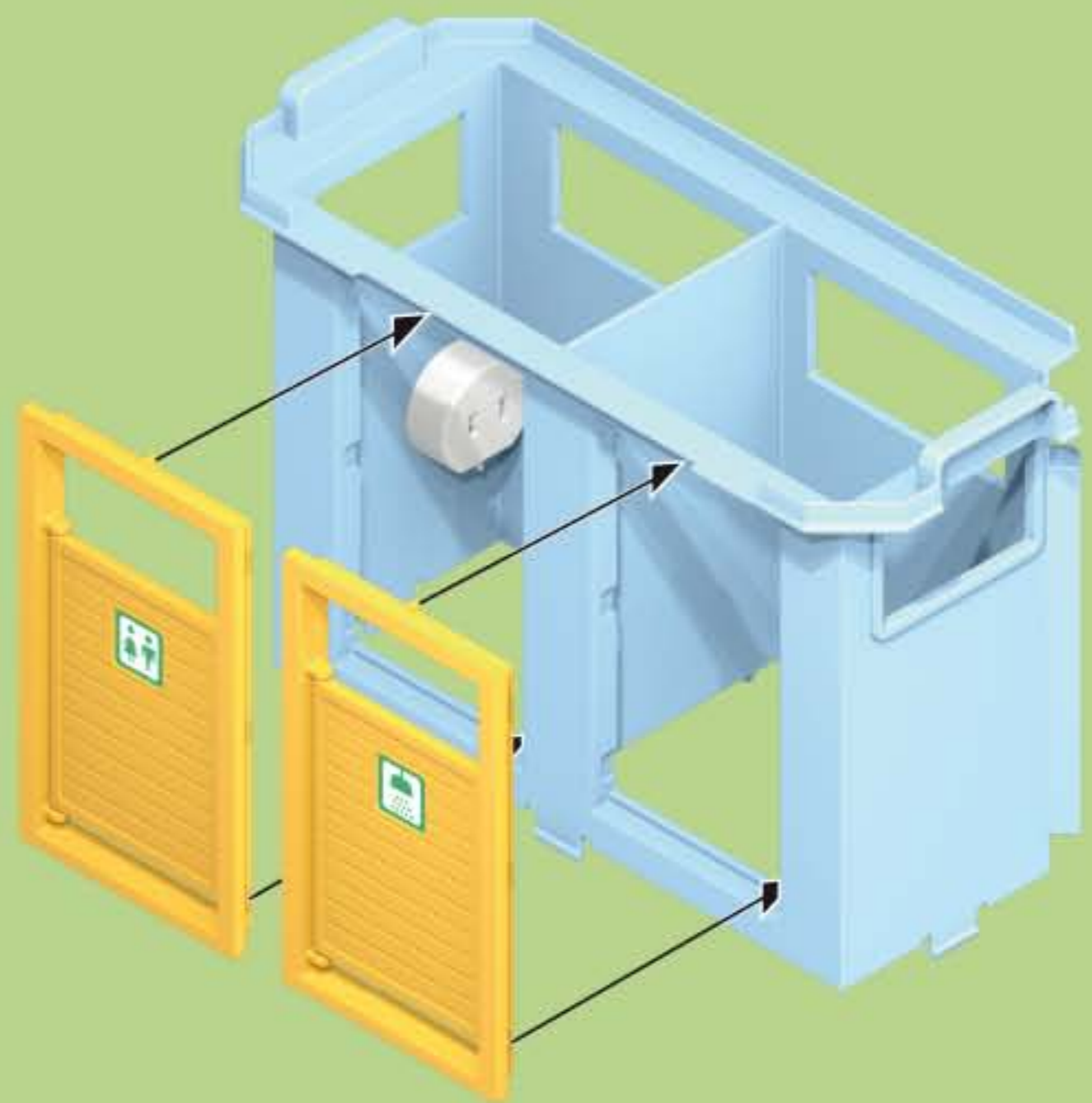
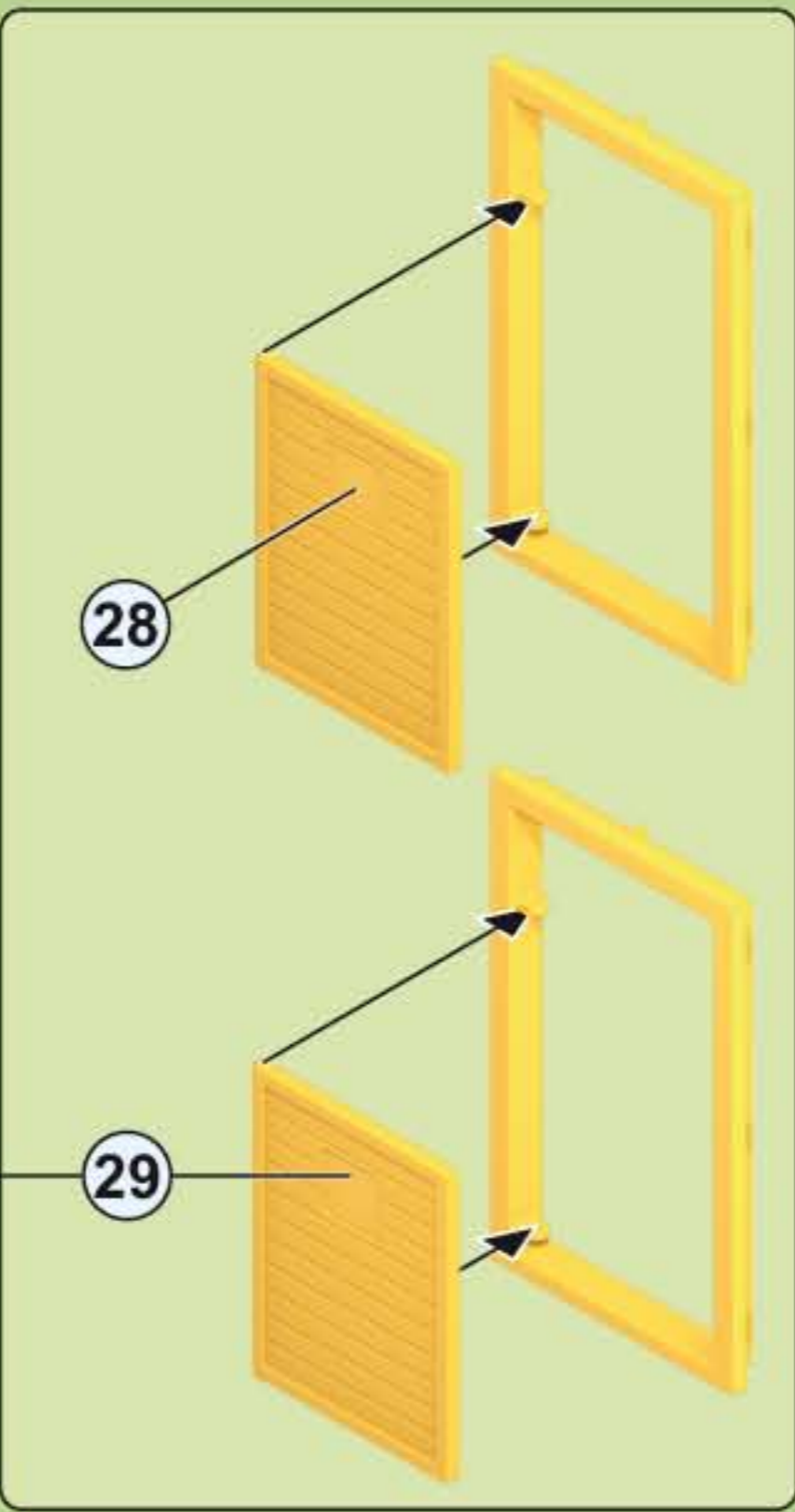

3

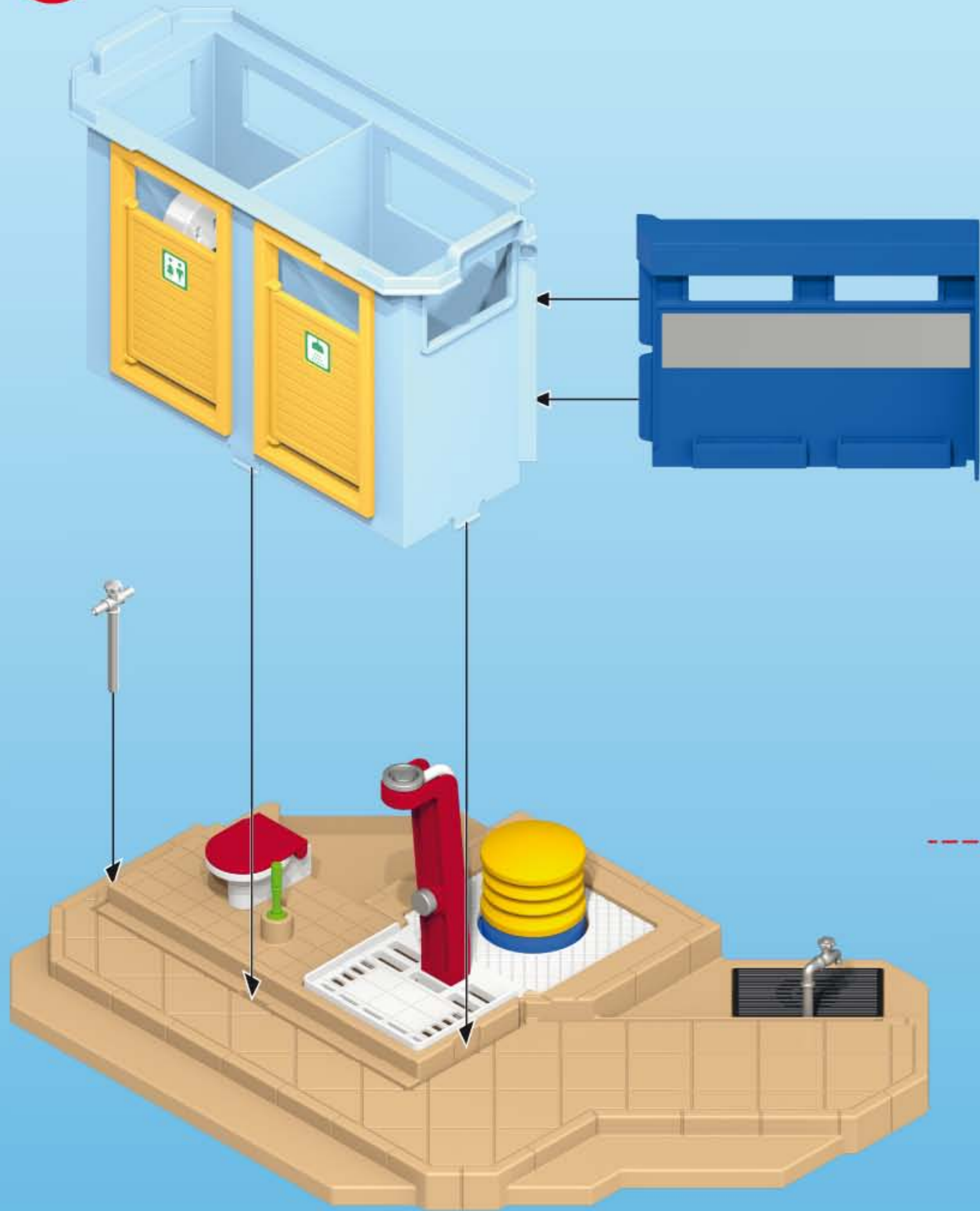

4

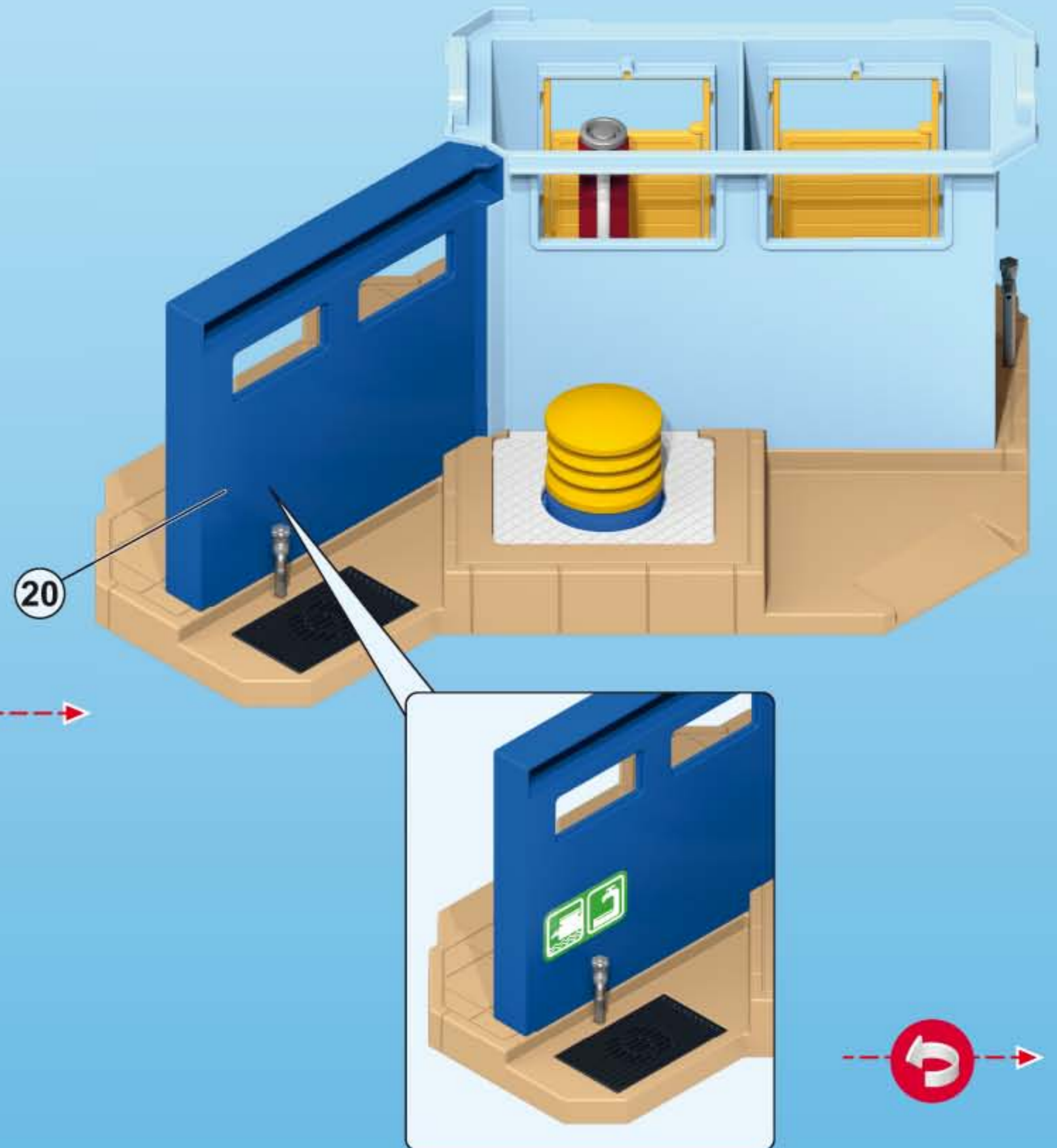

5

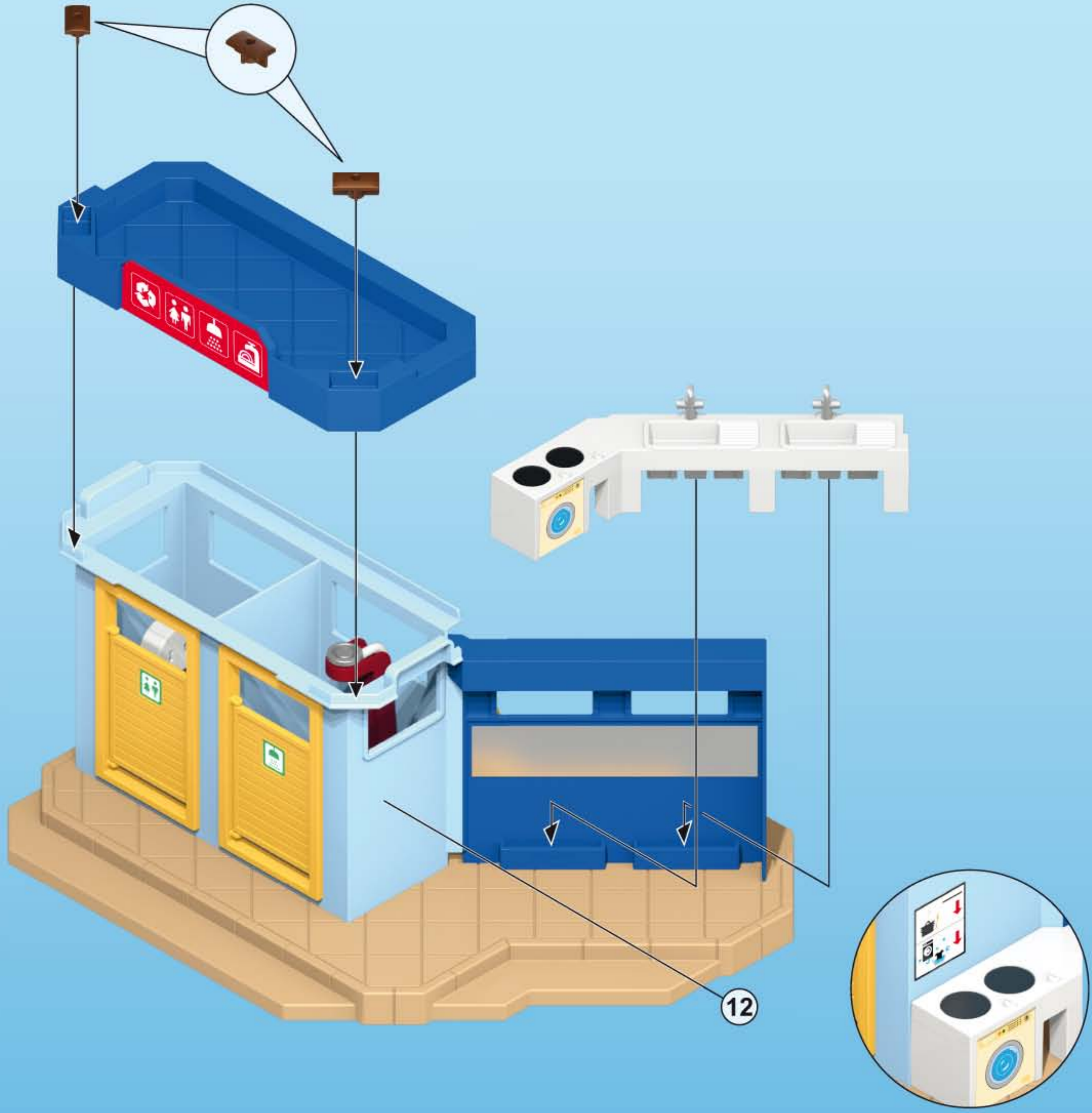
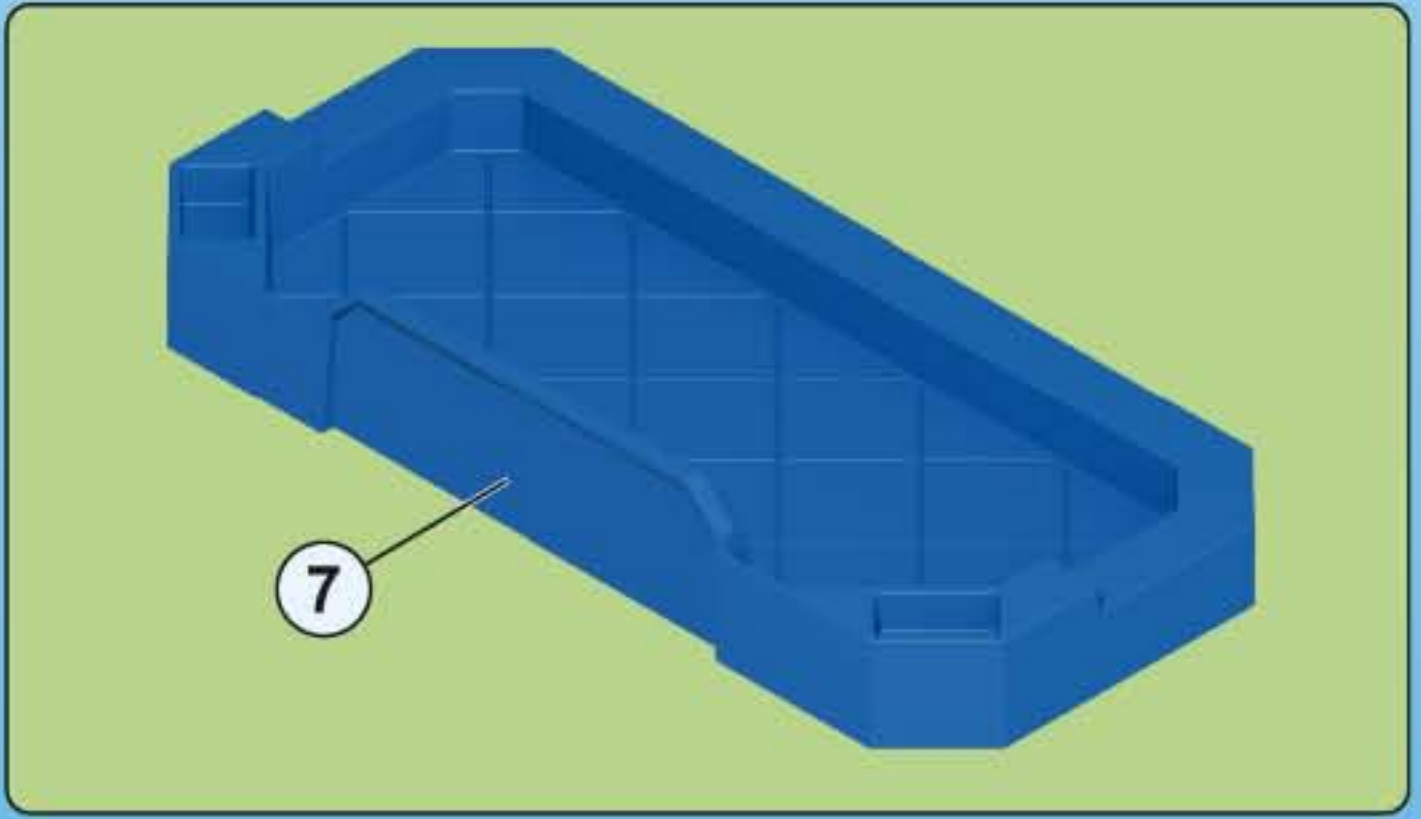
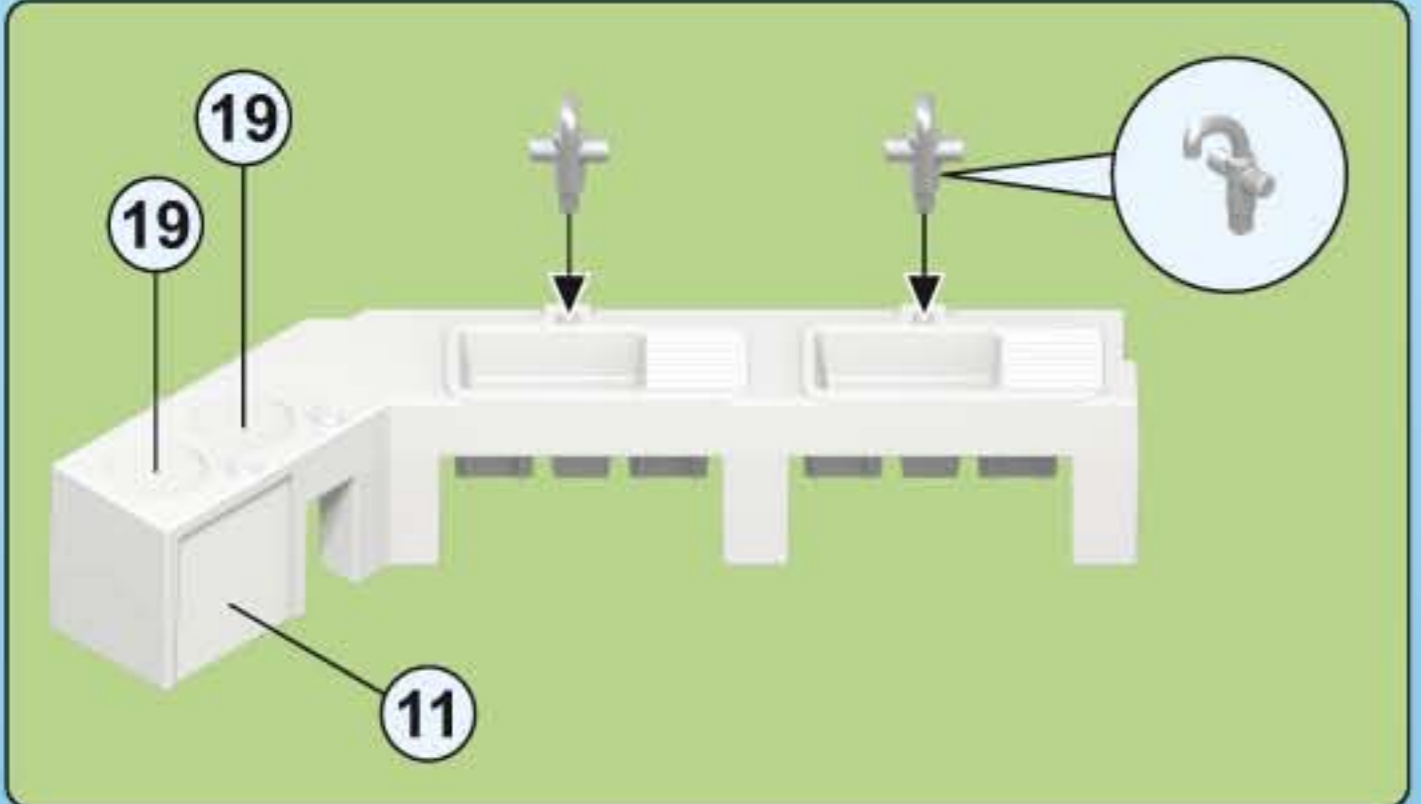

6

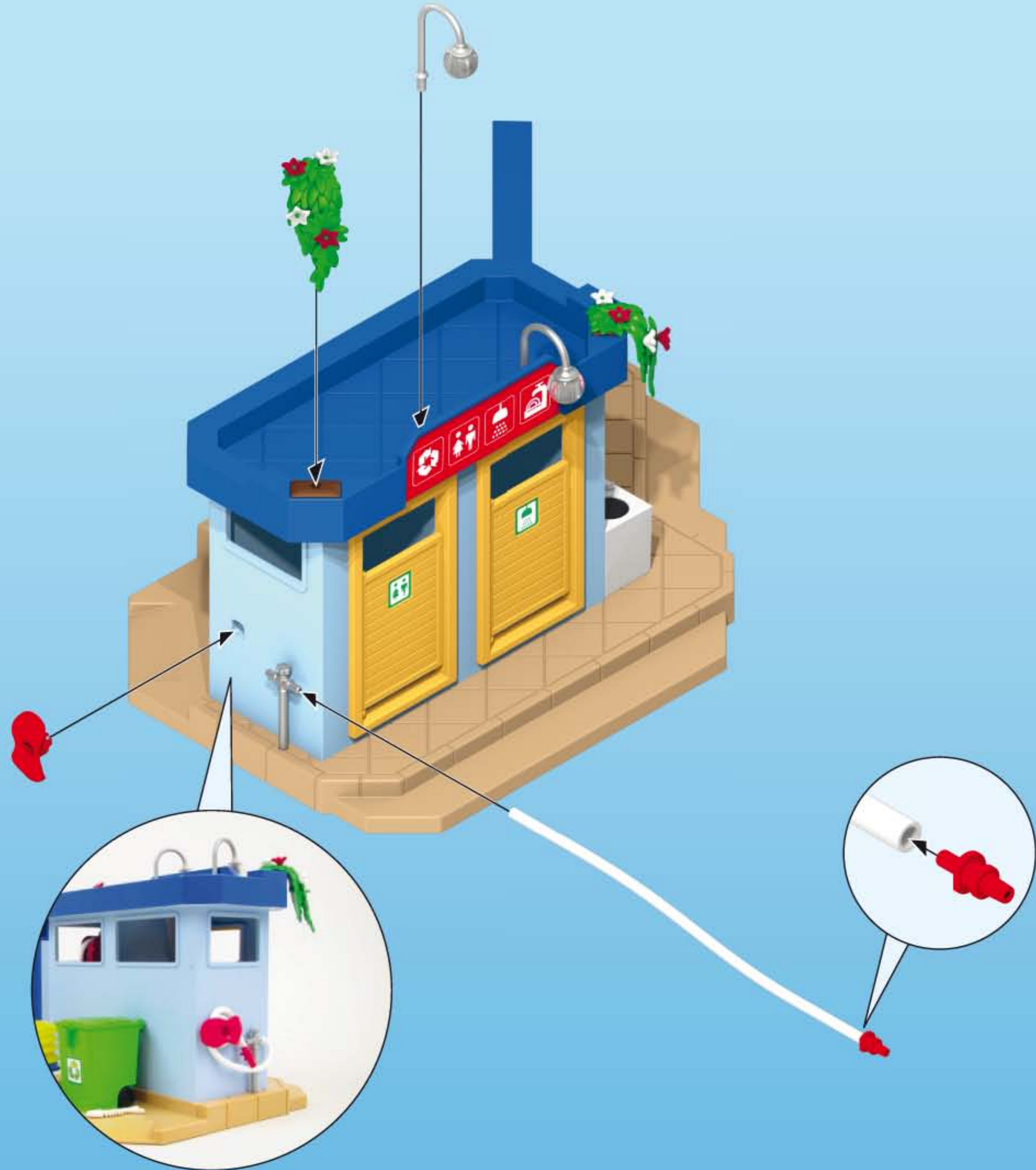
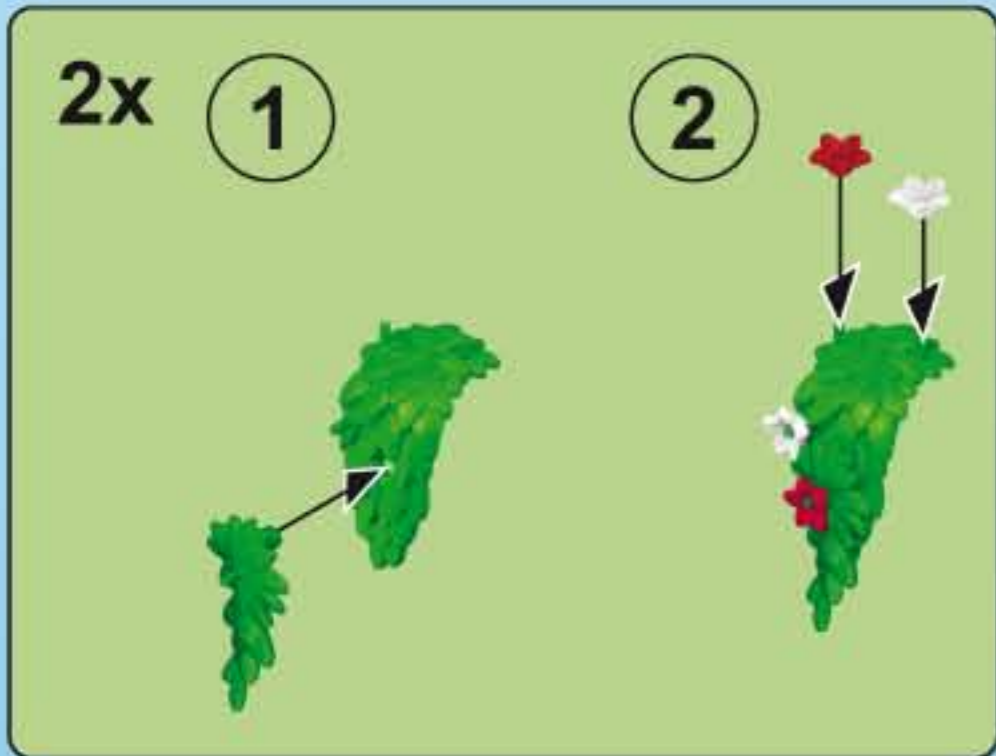
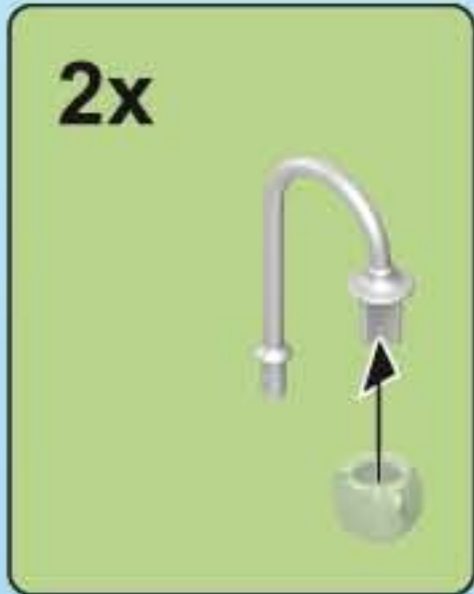

7



- DE AT CH LU BE ACHTUNG!** Nicht auf Augen oder Gesicht zielen. Nur Trinkwasser verwenden. Nach dem Spielen austrocknen lassen.
- US GB CA MT IE WARNING!** Do not aim at eyes or face. Use only tap water. Dry thoroughly after play.
- FR CA BE LU CH ATTENTION!** Ne pas viser les yeux ou le visage. N'utiliser que de l'eau potable. Faire sécher après chaque utilisation.
- ES MX ¡ADVERTENCIA!** No apuntar a los ojos ni a la cara. Utilizar solamente agua potable. Dejar secar antes de guardar.
- NL BE WAARSCHUWING!** Niet op ogen of gezicht richten. Enkel drinkbaar water gebruiken. Na het spelen laten drogen.
- IT CH AVVERTENZA!** Non mirare agli occhi o al viso. Usare solo acqua potabile. Asciugare bene dopo ogni uso.
- PT ATENÇÃO!** Não apontar para os olhos ou face. Utilizar somente água potável. Deixar secar antes de guardar.
- DK ADVARSEL!** Sigt ikke mod øjne eller ansigt. Anvend kun drikkevand. Lad det tørre ud når du er færdig med at lege.
- NO ADVARSEL!** Sikt ikke på ansikt eller øyne. Kun drikkevann skal benyttes. Tørk opp etter at leken er ferdig.
- SE FI VARNING!** Sikta inte mot ögon eller ansikte. Använd endast dricksvatten. Låt torka efter användandet.
- FI VAROITUS!** Ei saa kohdistaa suoraan silmiin tai kasvoihin. Käytä ainoastaan juomavettä. Anna kuivua leikin jälkeen.
- HU FIGYELMEZTETÉS.** Tilos szemre vagy arcra célozni. Kérjük kizárólag ivóvizet használnjon! Játék után ajánlott a termék kiszáritása!
- CZ UPOZORNĚNÍ!** Nemířte na oči nebo na obličej! Používat jen pitnou vodu. Po hraní nechat vyschnout.
- EE HOIATUS!** Ära sihi silmadesse ega näkku. Kasutada üksnes joogivett! Mängimise järel kuivatada!
- LV BRĪDINĀJUMS!** Nevērst pret acīm vai seju. Izmantot tikai dzeramo ūdeni. Pēc spēlēšanās ļaut nožūt.
- LT ĮSPĖJIMAS!** Netaikyti į akis arba veidą. Naudokite tik geriamąjį vandenį. Pažaidus, išdžiovinkite.
- SI OPOZORILO!** Ne merite v oči ali obraz. V igračo vlivajte le pitno vodo. Po igri naj se igrača posuši.
- SK UPOZORNENIE!** Nemieriť do očí alebo do tváre. Používať iba pitnú vodu. Po hre nechať vyschnúť.
- PL OSTRZEŻENIE!** Nie celować w oczy i twarz. Używaj tylko wodę pitną. Po zabawie pozostaw do wyschnięcia.
- TR CY DİKKAT!** Göze veya yüze doğru tutmayınız. Sadece içme suyu kullanınız. Oyundan sonra kurumaya bırakın.
- GR CY Προειδοποίηση!** Μη μην γίνεται στόχευση στα μάτια ή στο πρόσωπο. Χρησιμοποιείτε μόνο νερό βρύσης. Μόλις τελειώσετε, αφήστε το παιχνίδι να στεγνώσει εντελώς.
- RO AVERTISMENT!** Nu se țintește în ochi sau în față. Se folosește doar apă potabilă. După joacă se lasă să se usuce.
- BG Внимание!** Не насочвайте към очите и лицето. Използвайте само питейна вода. След игра оставете да изсъхне.
- HR UPOZORENJE!** Ne ciljati u oči ili lice. Koristiti samo pitku vodu. Poslije igranja pustiti da se osuši.
- CN 警告!** 请勿瞄准眼睛或脸。仅使用饮用水。玩耍后要干燥。

3

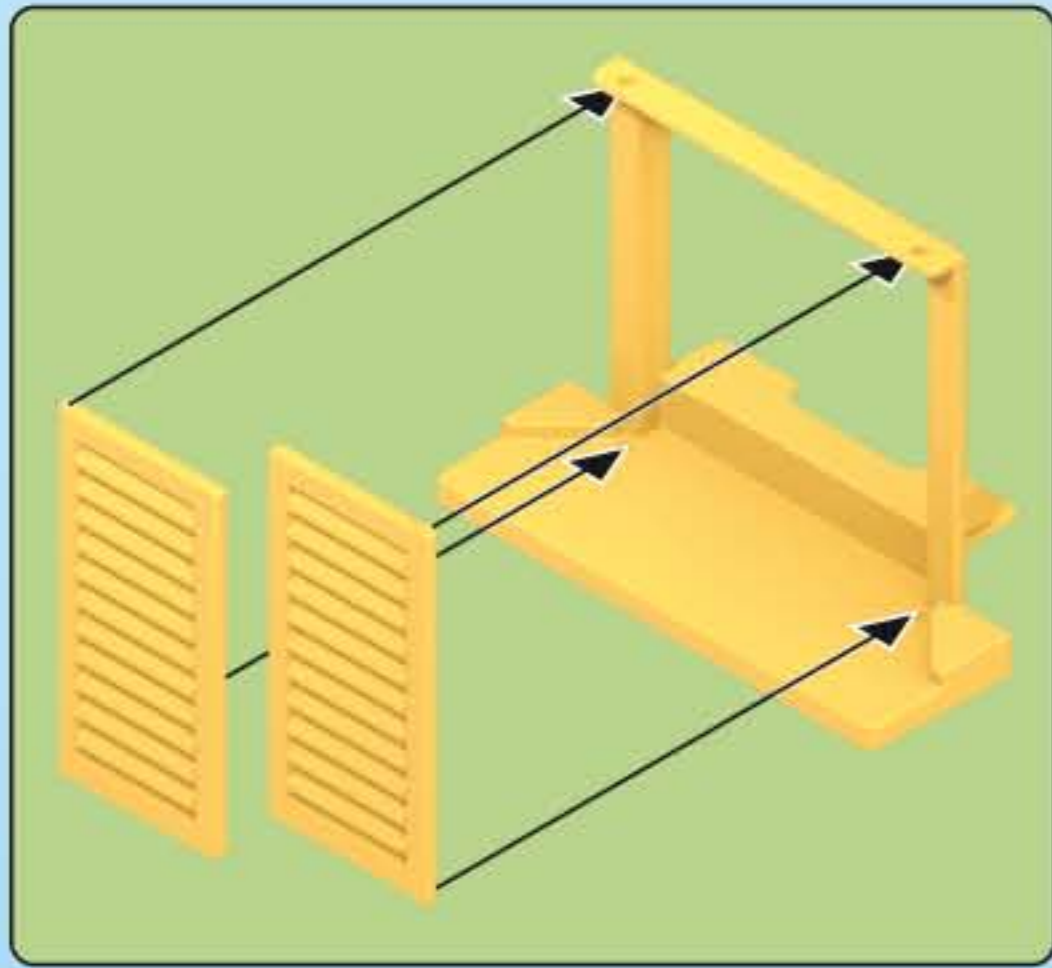

4

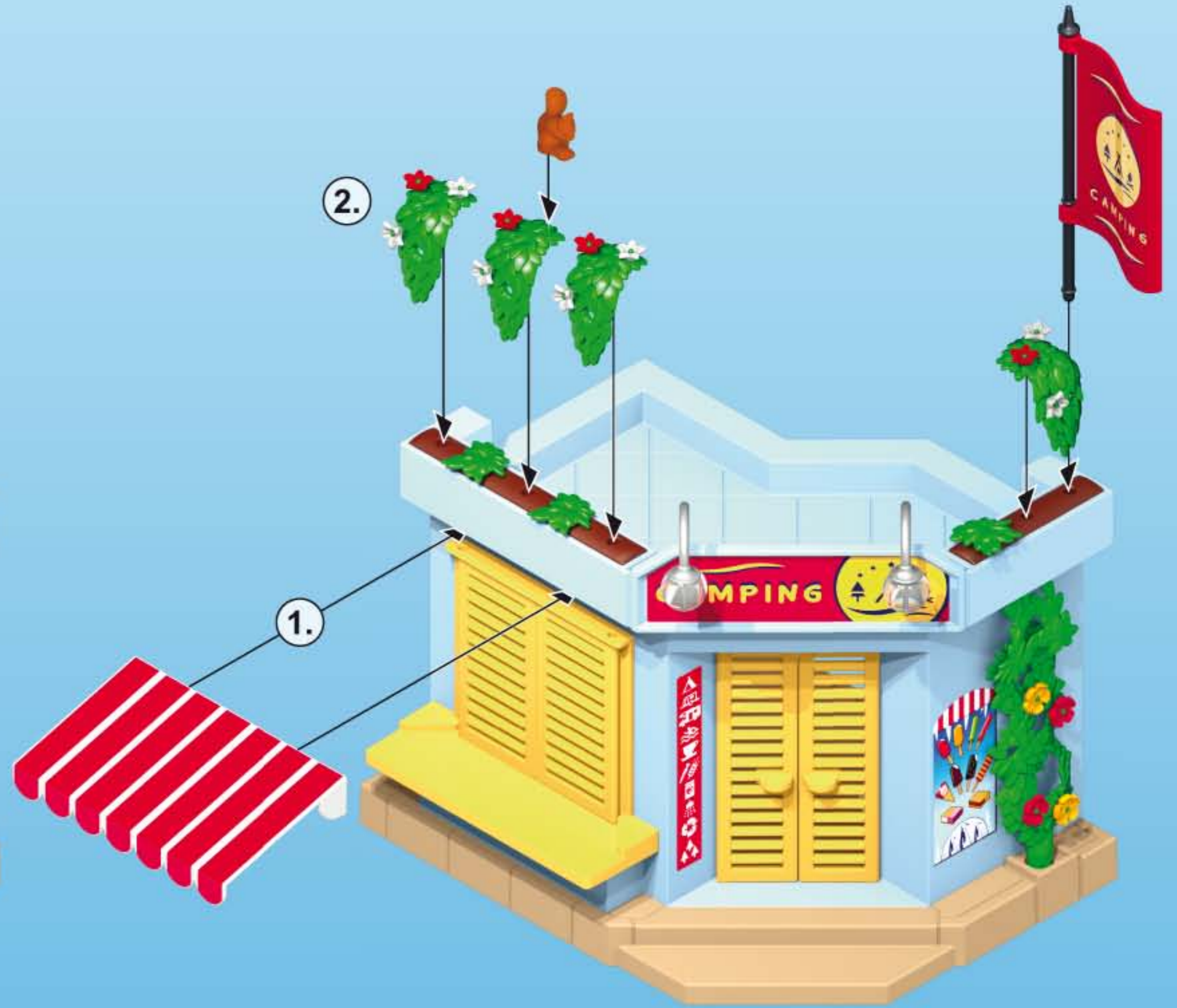
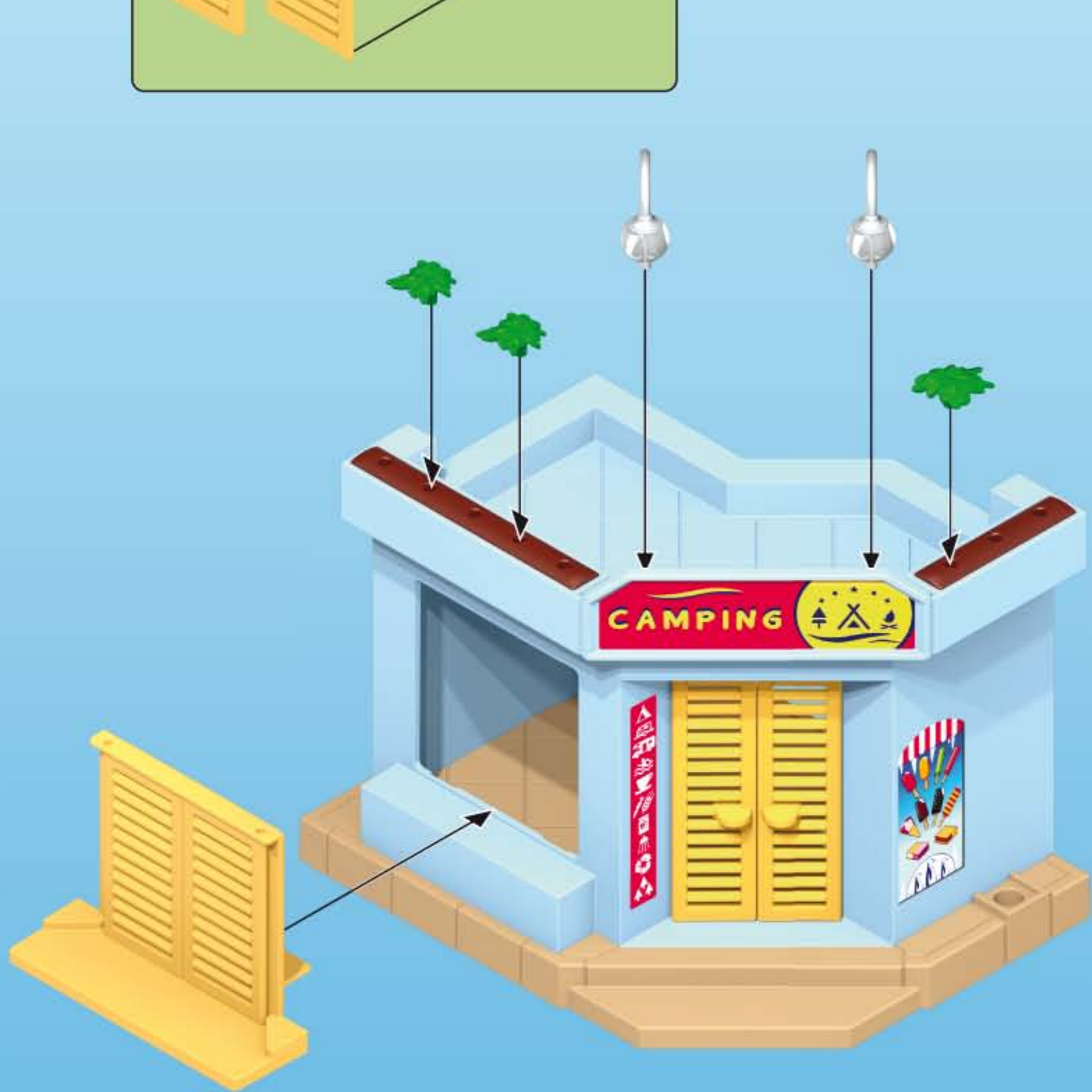
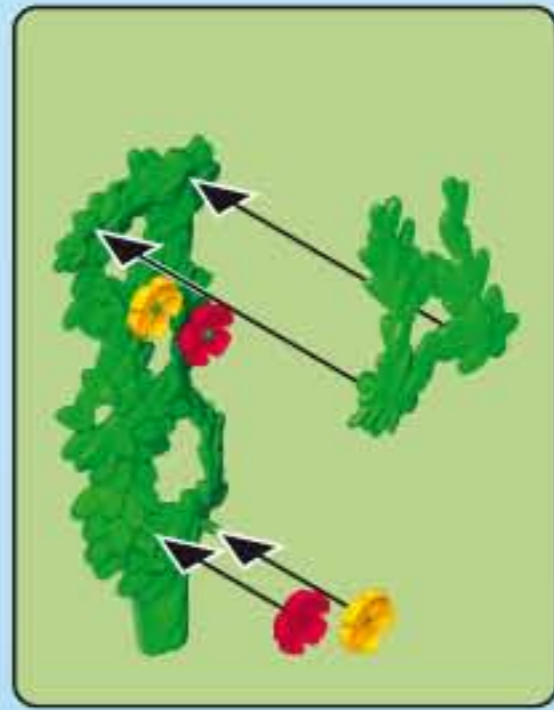
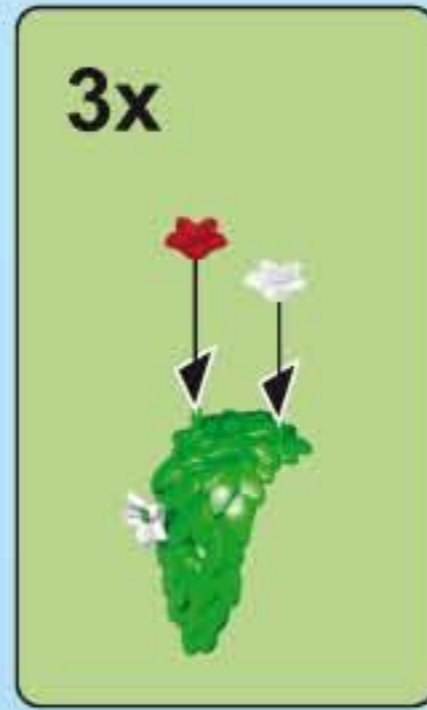

1

30 25 1513

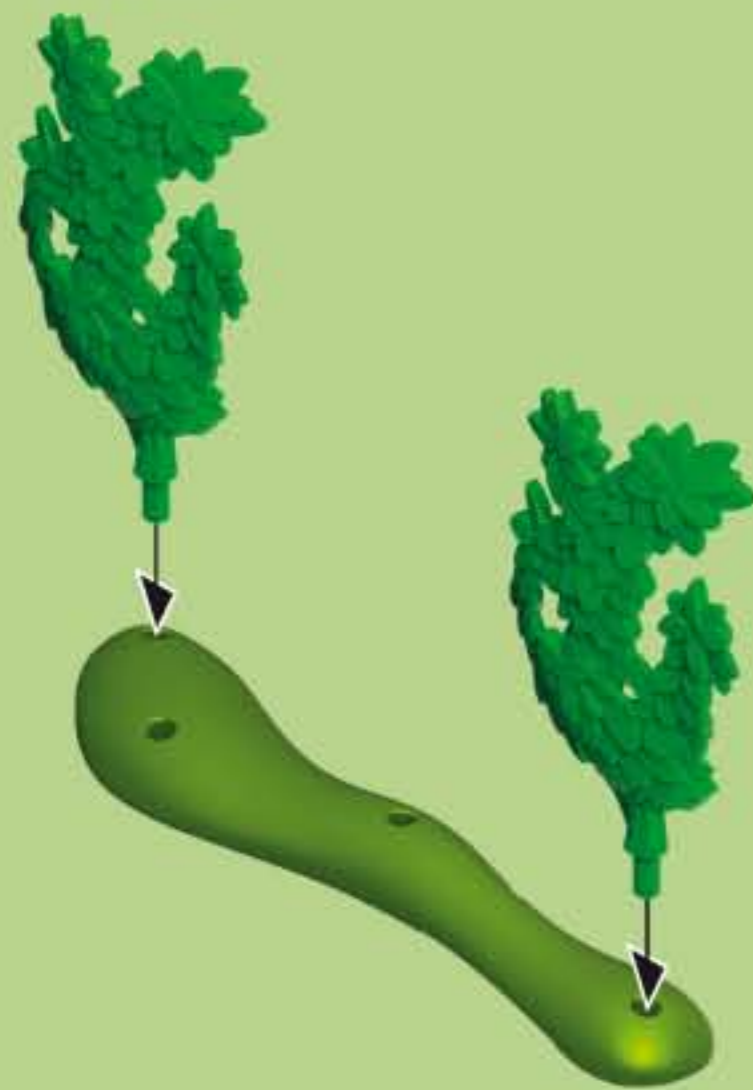

30 04 4133

2

30 62 4656



30 23 8613

3



30 03 2920

1

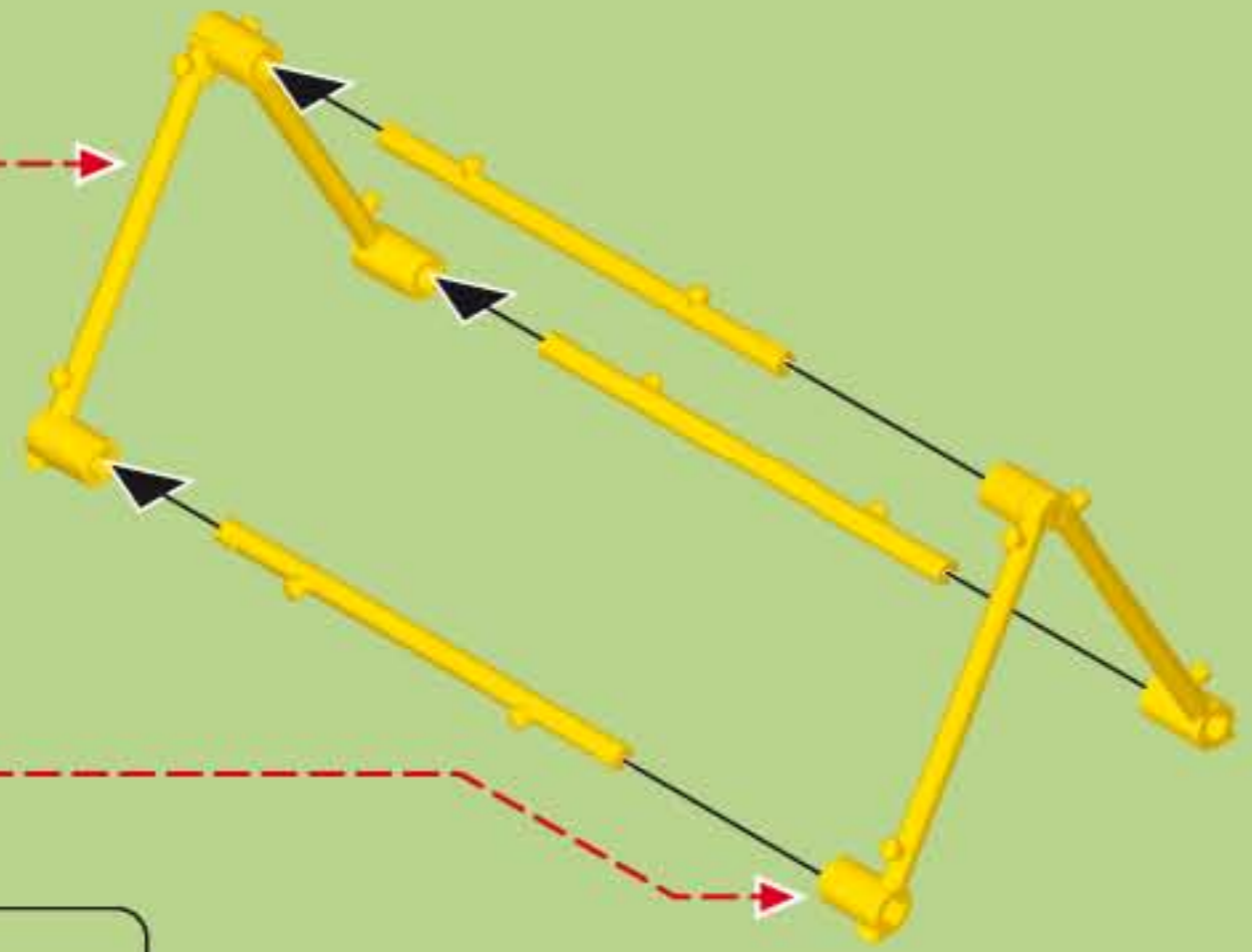
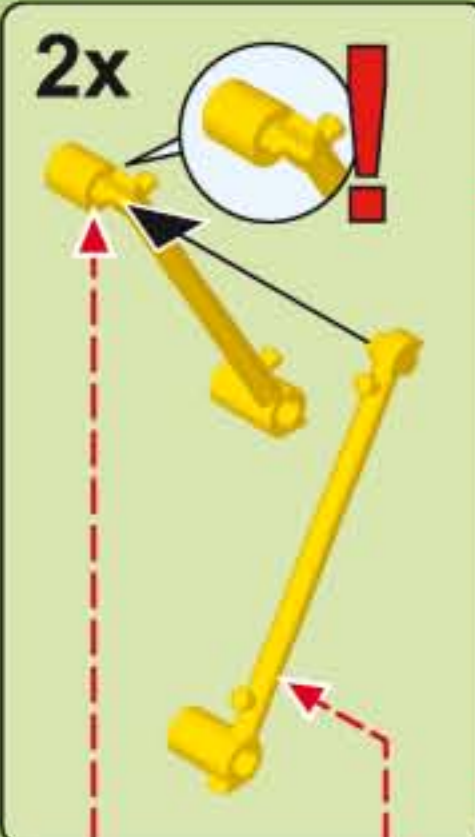

2

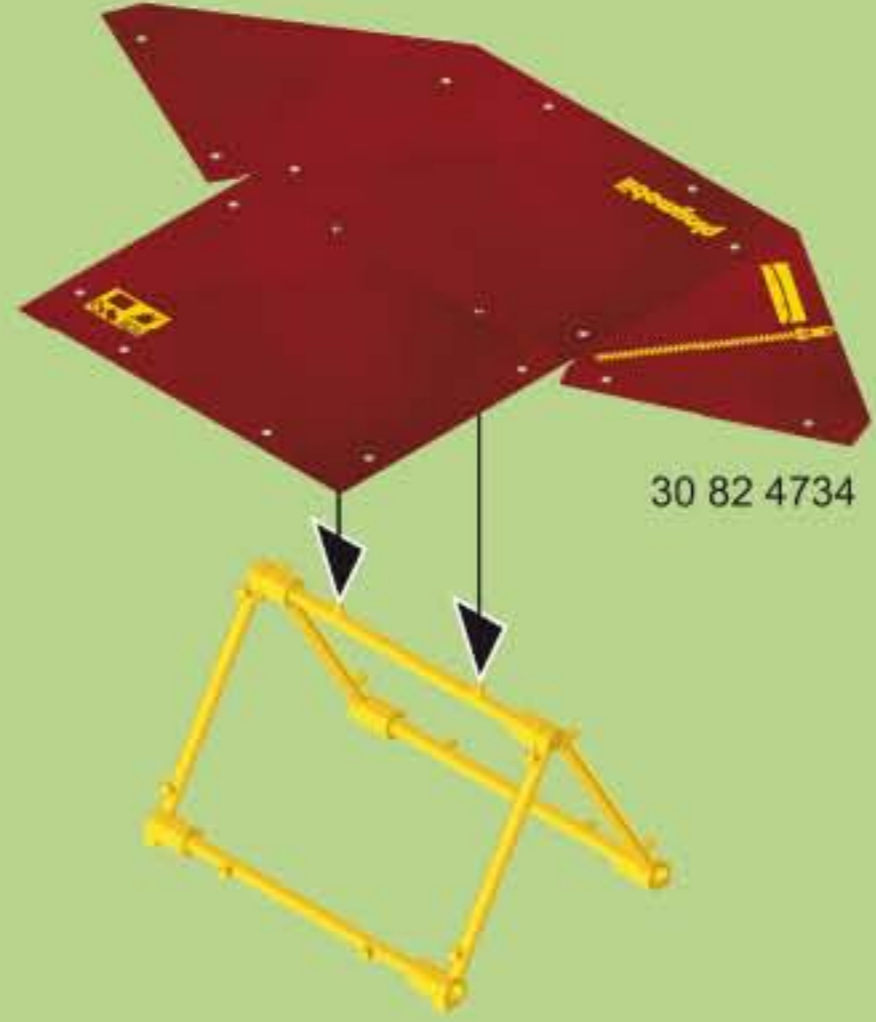

3

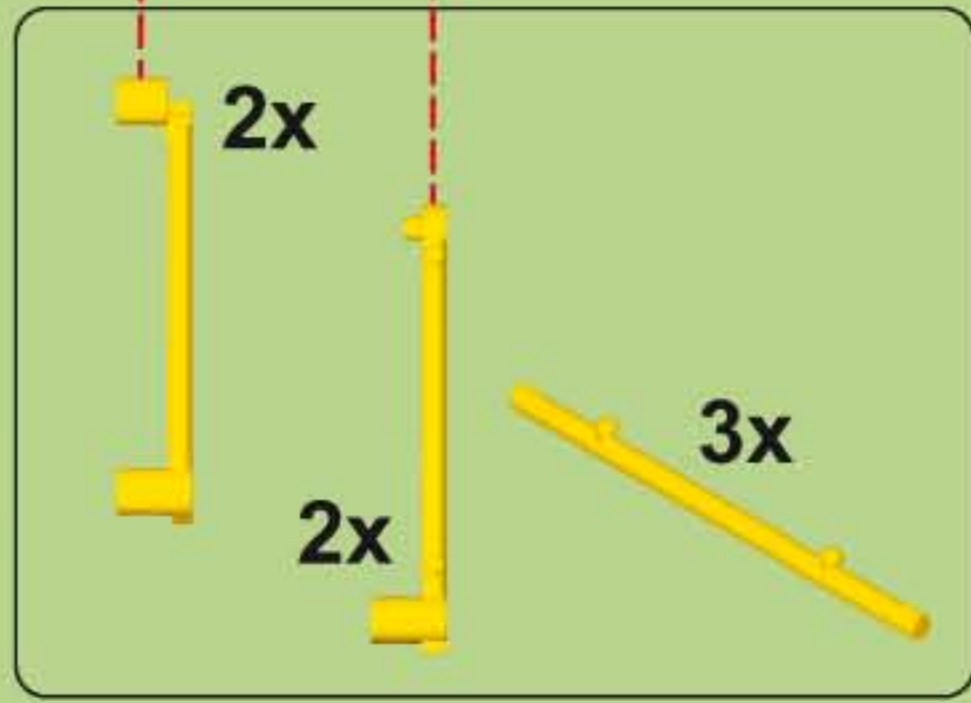

30 51 1972



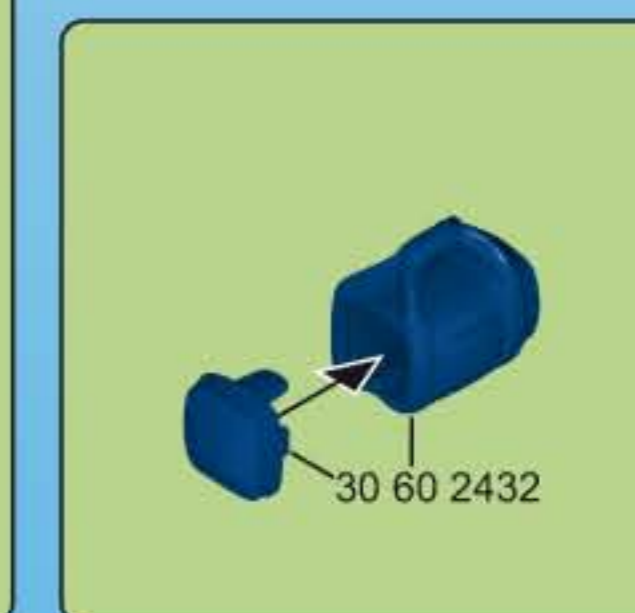
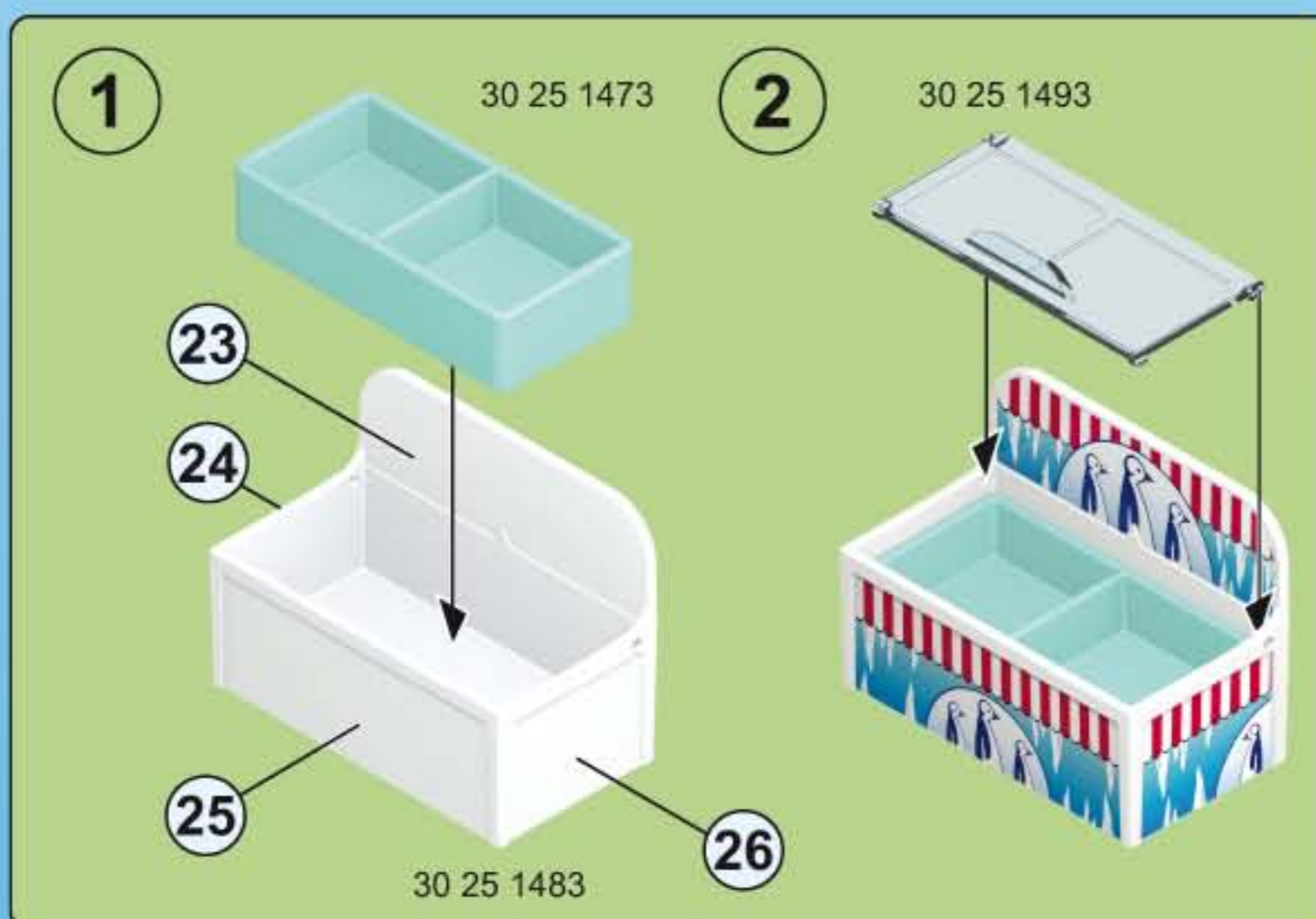
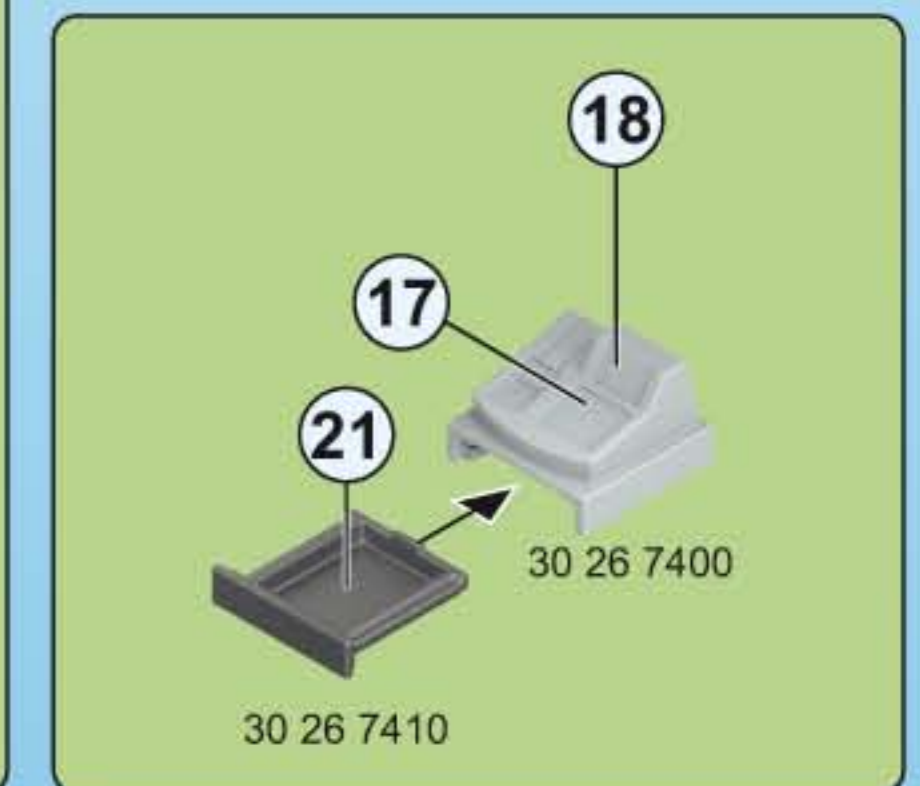
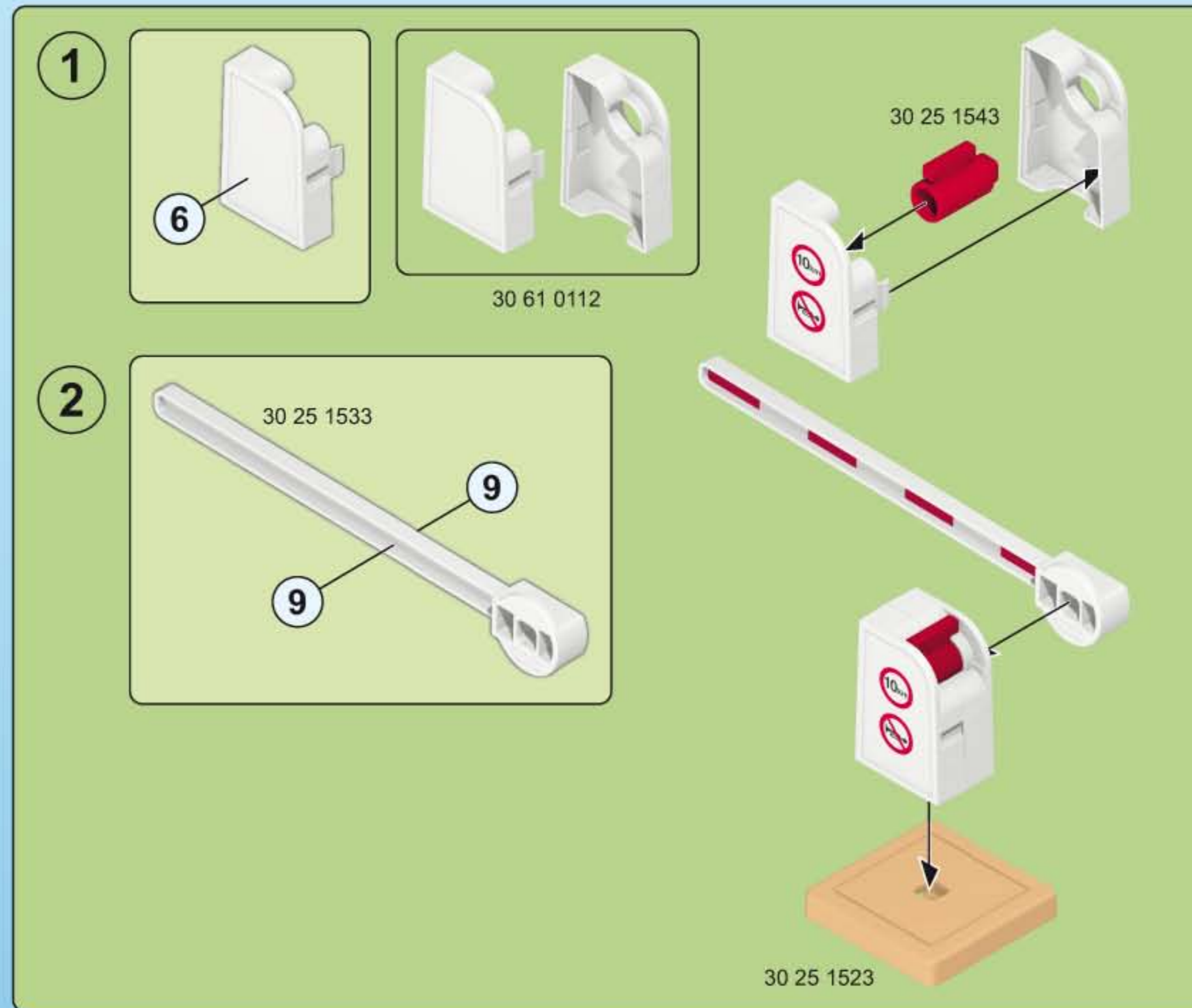
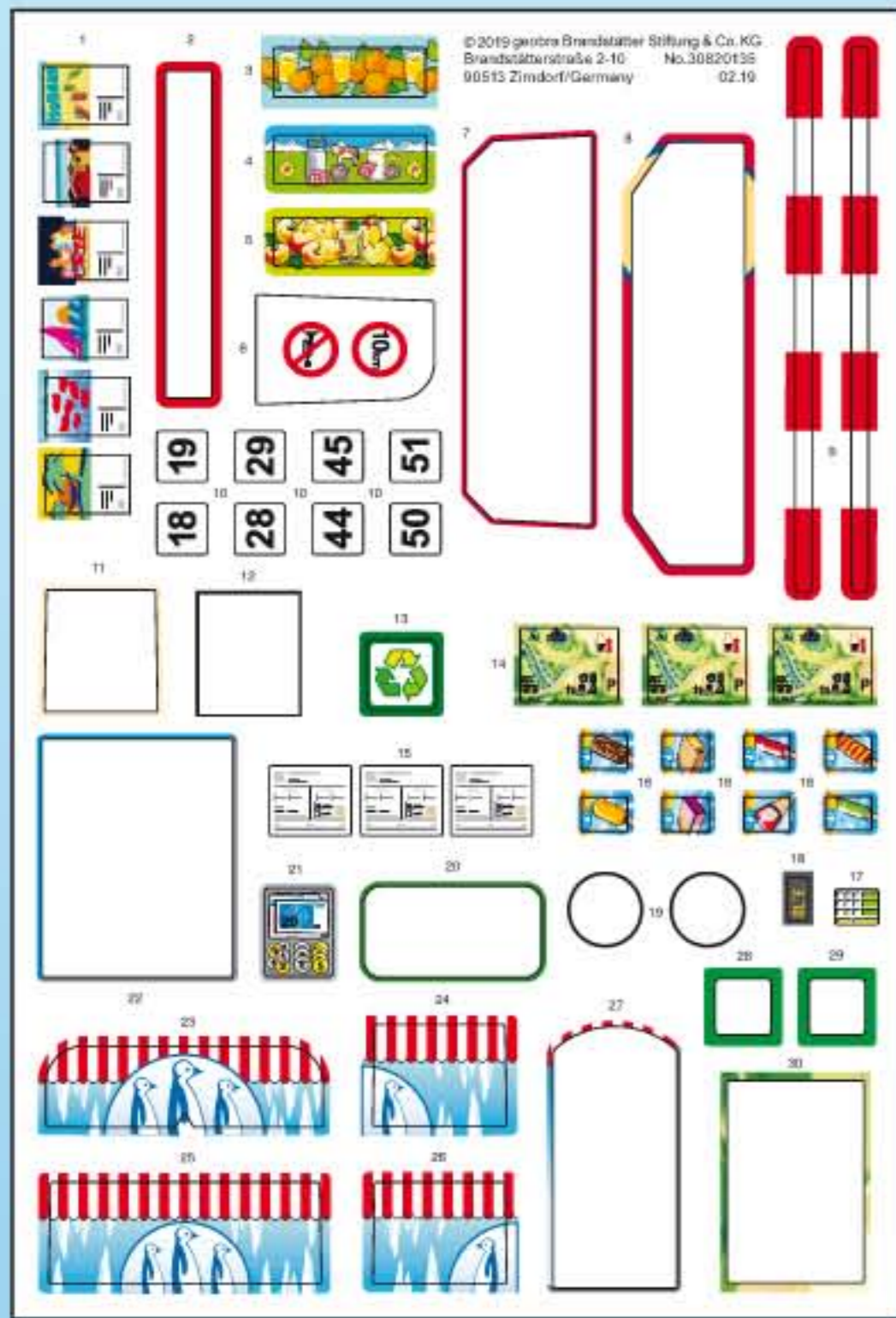

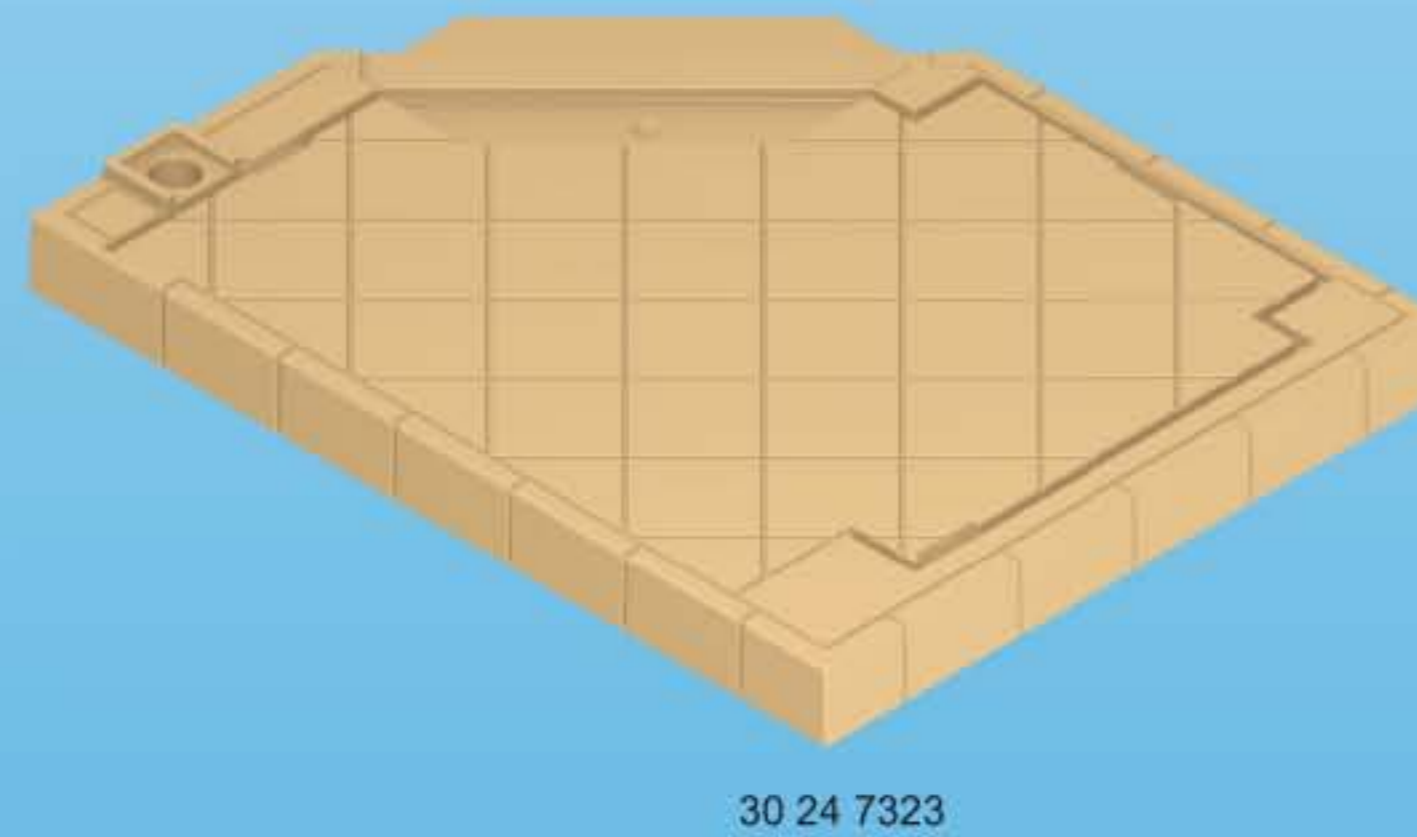
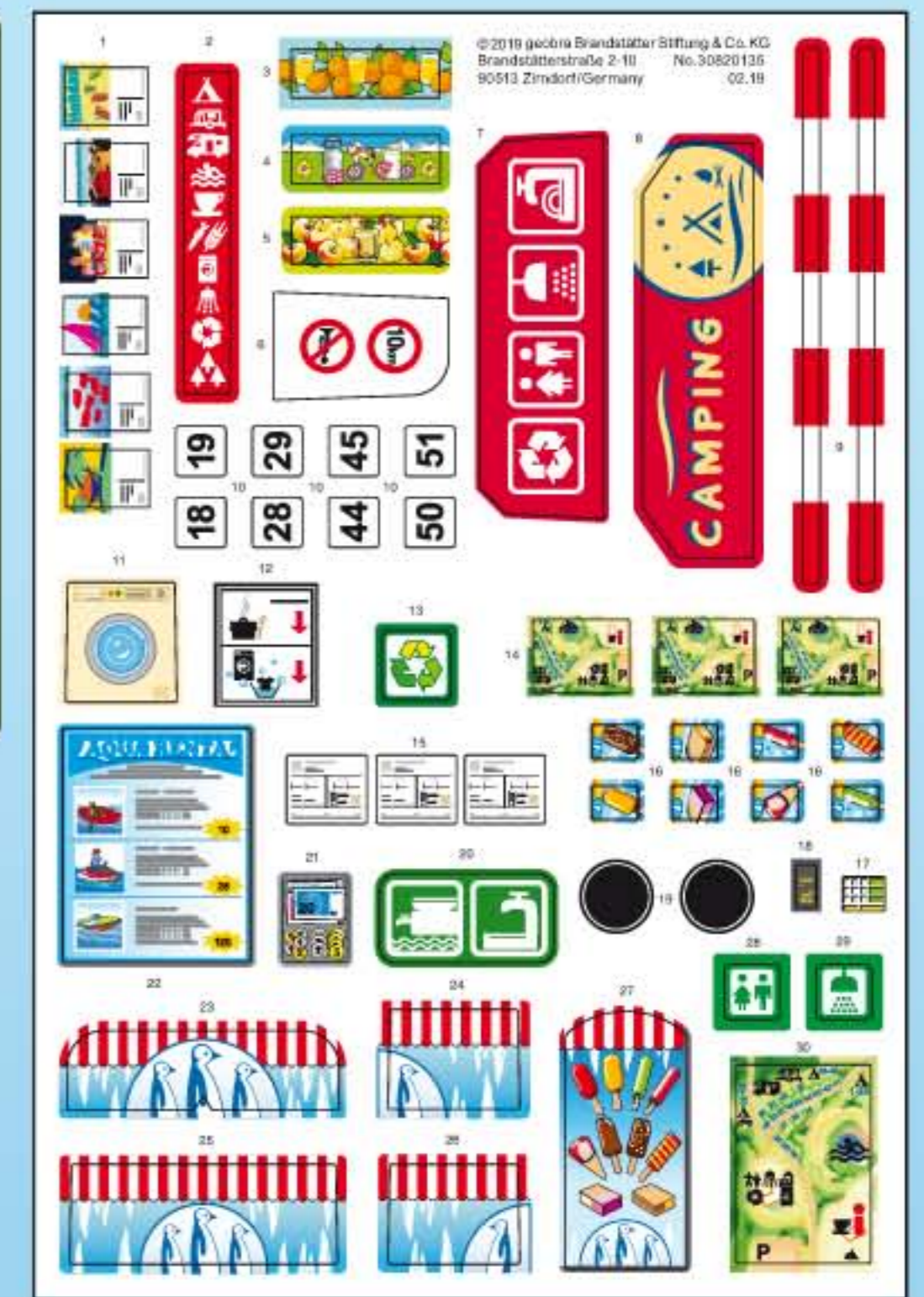



30 03 1933

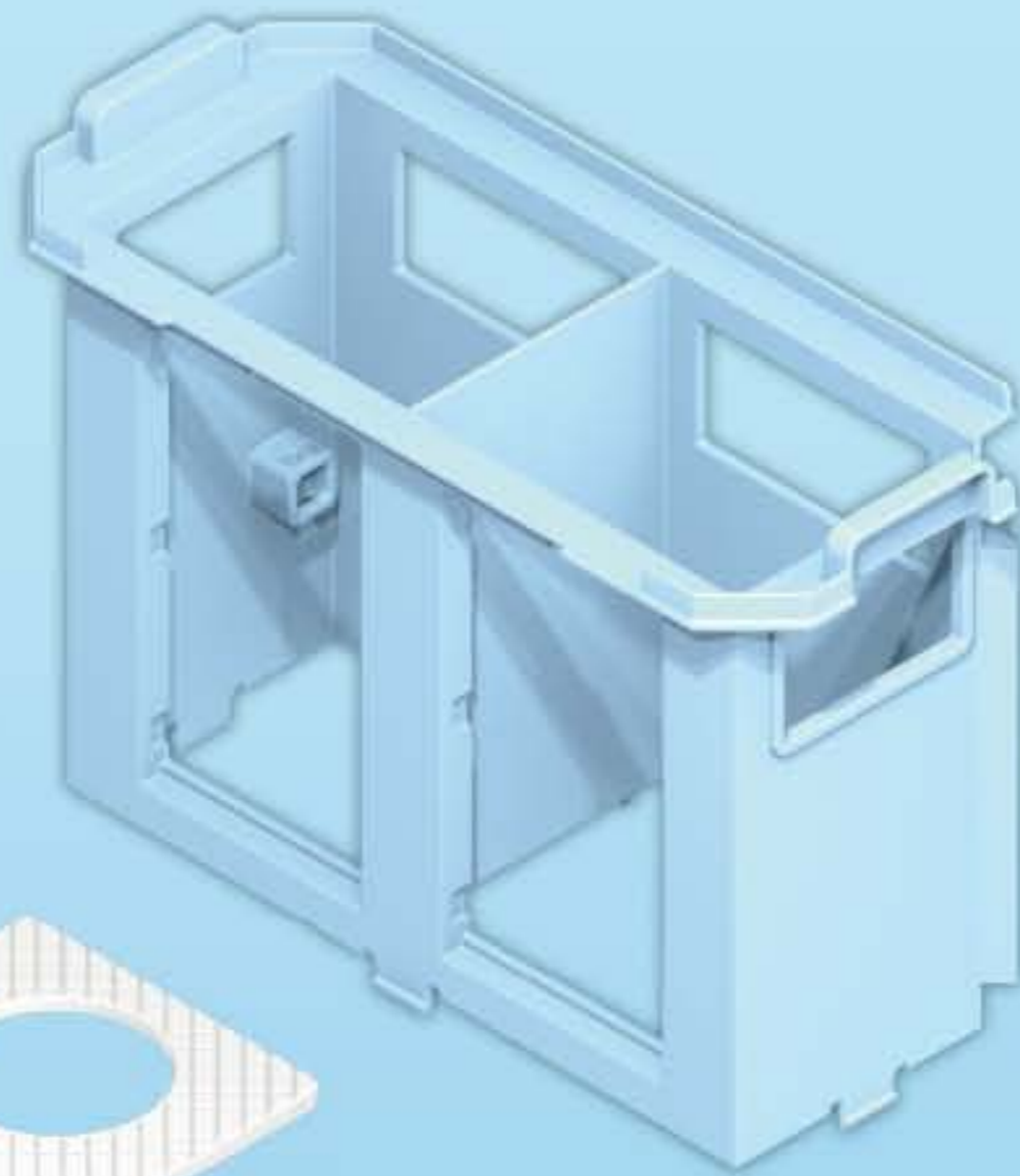

30 03 1913

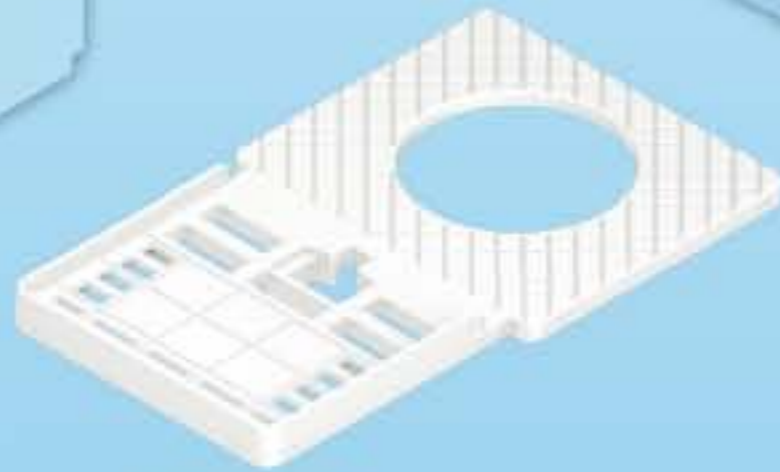

30 25 1673



30 62 4666

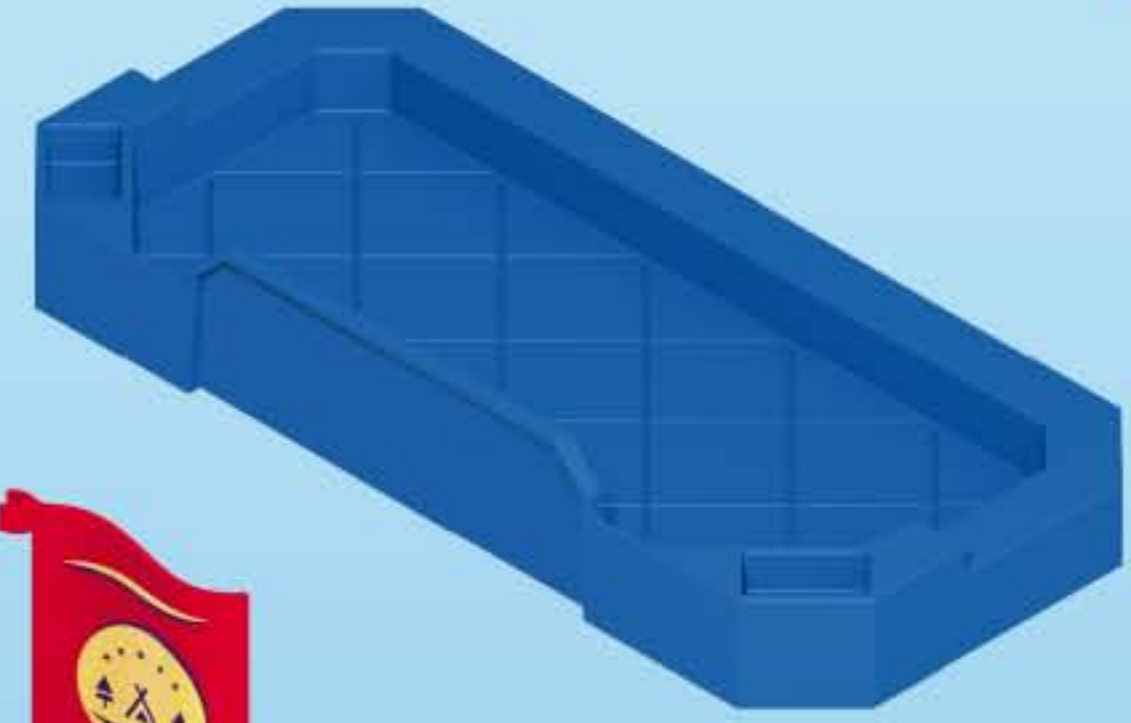

30 46 5412



30 62 4686



30 02 3190



30 03 1943



2x 30 46 5752



2x 30 46 6012



2x 30 45 1822



2x 30 45 1812



30 25 1573



30 03 1893



30 82 4764



30 82 4754



30 03 1923



30 89 0962



30 80 6823



30 28 1950



30 27 9940

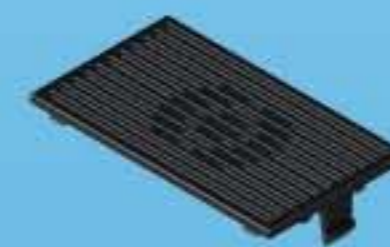

30 21 4662



30 62 4676



30 25 2142



30 29 9740



2x 30 21 1302



30 23 1050



30 21 4972



30 03 1883



30 25 2053



30 25 1723



30 25 9003



30 28 8830



6x 30 21 4422



30 04 2980



3x 30 04 2760



2x 30 28 7640



30 07 9652



30 03 1863



30 29 1460



30 03 4640



30 73 2212



4x 30 25 1553



30 25 1633



30 25 1643



2x 30 25 1653



30 24 2212



30 62 6063



4x 30 22 3323



30 23 0460



30 28 4430

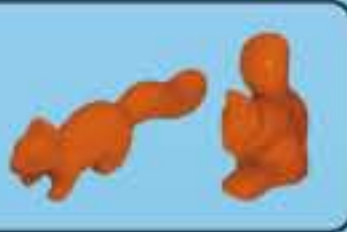

30 51 3880



30 09 5540



30 63 6082



30 25 1403



30 27 4260



30 23 1330



30 03 1903



30 25 2063



4x 30 25 1563

17 cm / (6,7 inch)



30 80 8313

12,5 cm / (4,9 inch)



30 89 0972



30 25 1623



30 60 1192



3x 30 25 8720



12x 30 25 2810



8x 30 25 2820



2x 30 09 4659



2x 30 24 9829

Abbildungen können vom Original abweichen. / Product may differ from image shown.
Les illustrations peuvent différer de l'original. / Afbeeldingen kunnen verschillen van het werkelijke artikel.

© 2019 geobra Brandstätter Stiftung & Co.KG
Brandstätterstr. 2-10
90513 Zirndorf, Germany.
No. 30 82 2795 02.19



100%

www.playmobil.com