

playmobil®

6929



WARNING: CHOKING HAZARD

Small parts. Not for children under 3 years.

"Ne concerne que les USA"

Wichtige Unterlagen, bitte sorgfältig aufbewahren!
Important: Please keep these instructions for future reference!
Documents importants, à conserver soigneusement!
Belangrijke documenten, bewaar deze zorgvuldig!



UK-Importer:
Playmobil UK Ltd.
Regency House

1 Miles Gray Road

Basildon

Essex

SS14 3RW

UK

**UK
CA**

Serviceadressen finden Sie in allen PLAYMOBIL-Prospekten

Addresses of Customer Service Departments are shown in all PLAYMOBIL catalogues

L'adresse du service consommateurs est indiquée dans tous les catalogues PLAYMOBIL

Troverete gli indirizzi dei centri di assistenza in tutti i cataloghi PLAYMOBIL

In alle PLAYMOBIL catalogi vindt u het adres van onze klantendienst.

Las Direcciones de los Departamentos de Servicio al Consumidor se encuentran en todos los catálogos PLAYMOBIL

Η διεύθυνση του Γραφείου Εξυπηρέτησης Καταναλωτών PLAYMOBIL βρίσκεται σε όλους τους καταλόγους PLAYMOBIL.

pronounced: plāy-mō-bēēl

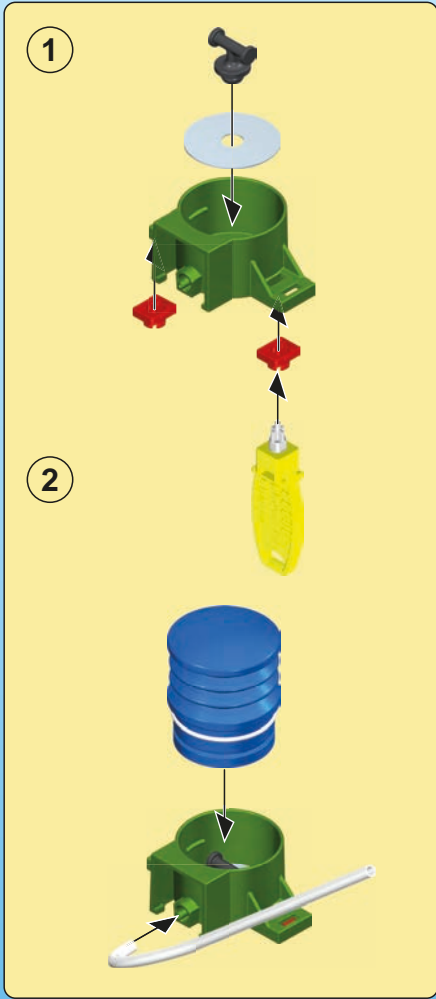

1

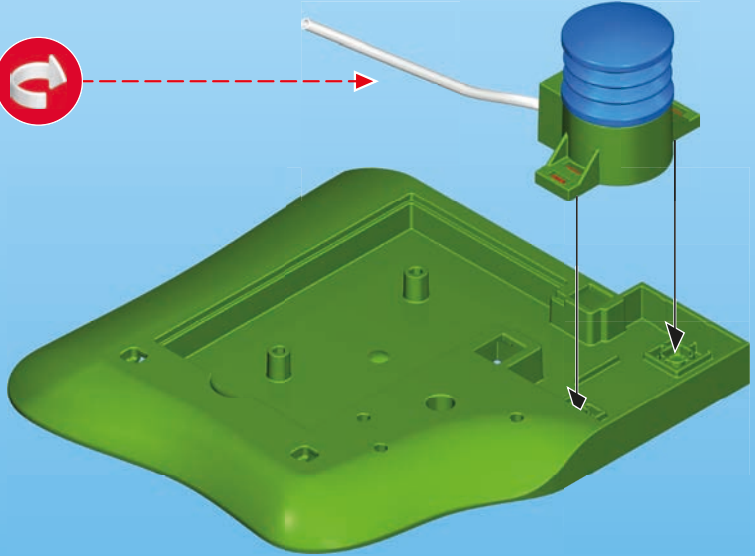

2

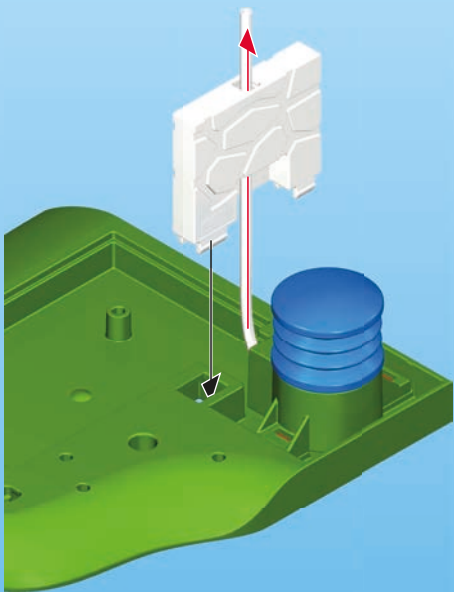

3

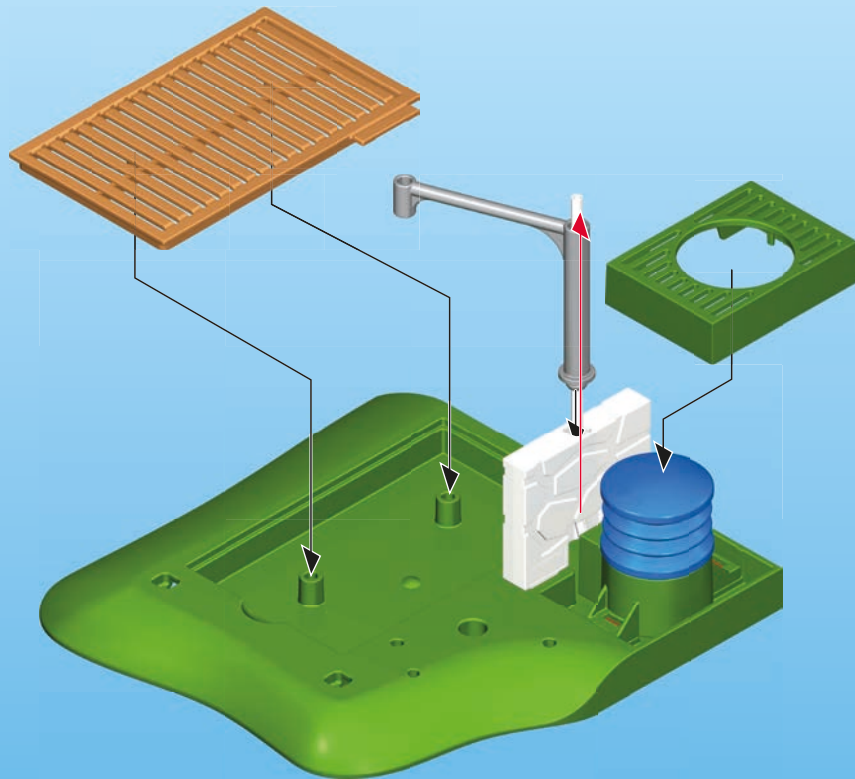

4

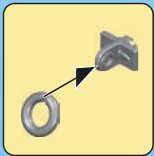
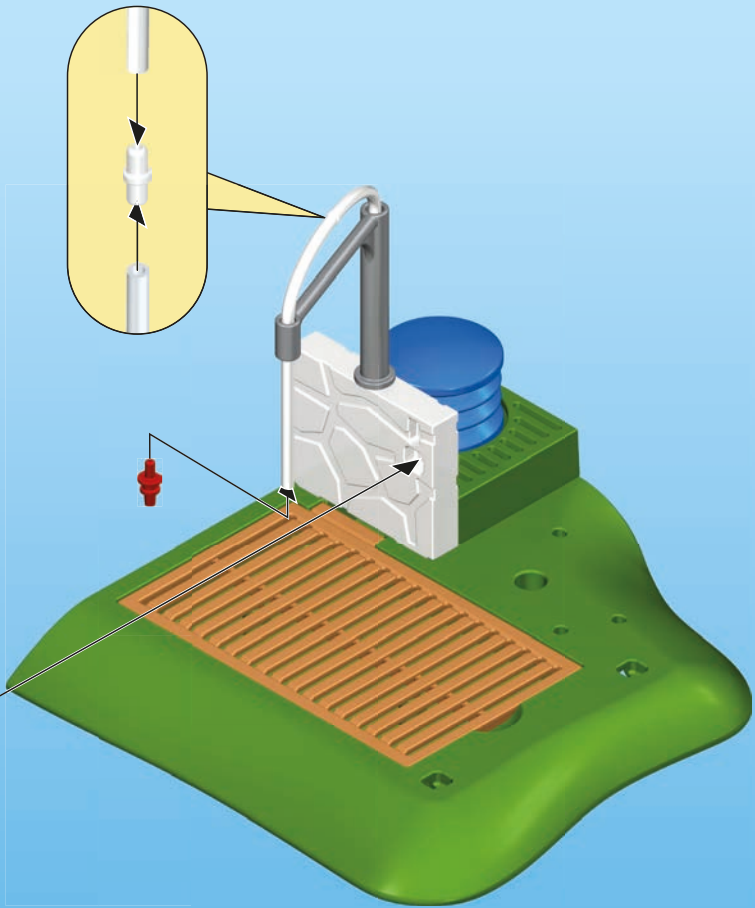

5

1 2x

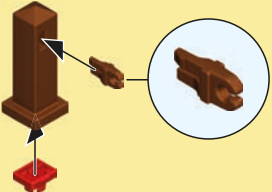

2

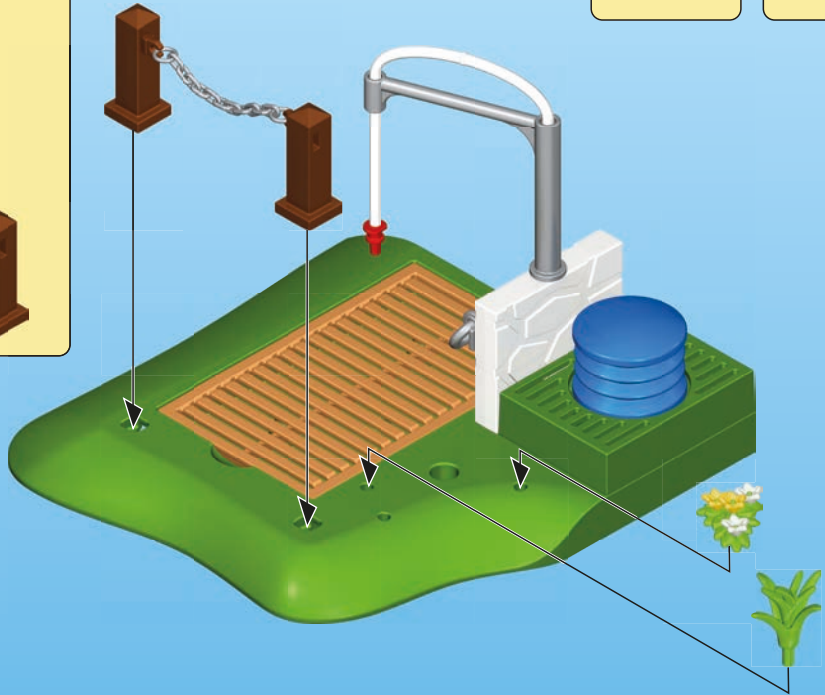
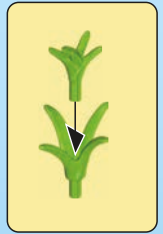
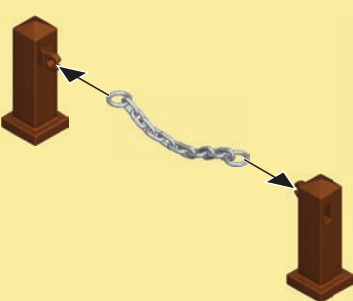

6

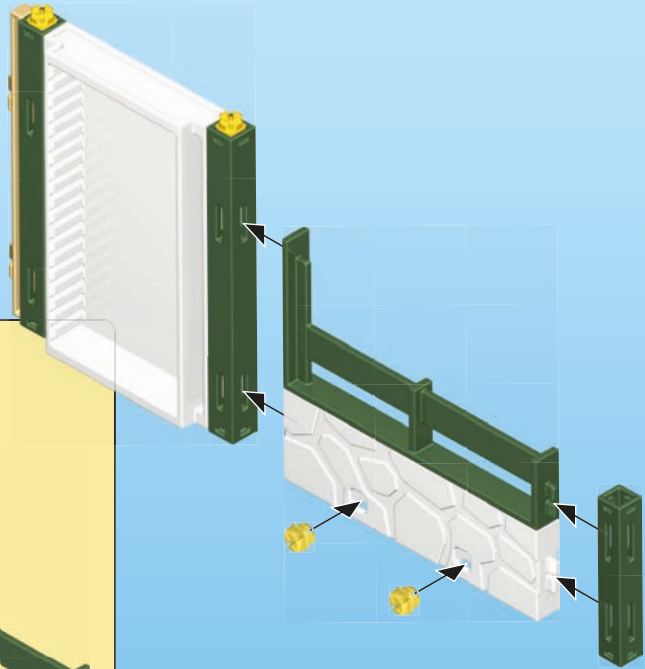
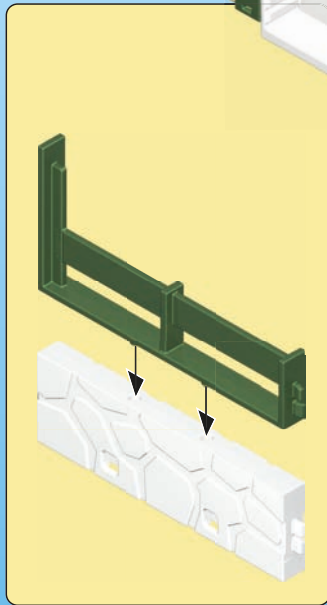
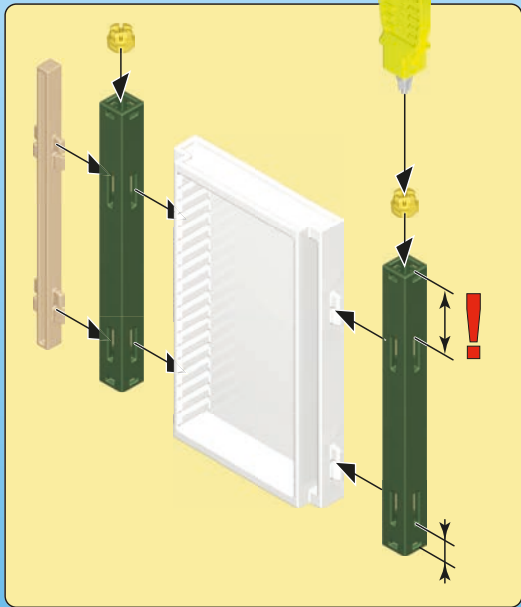

7

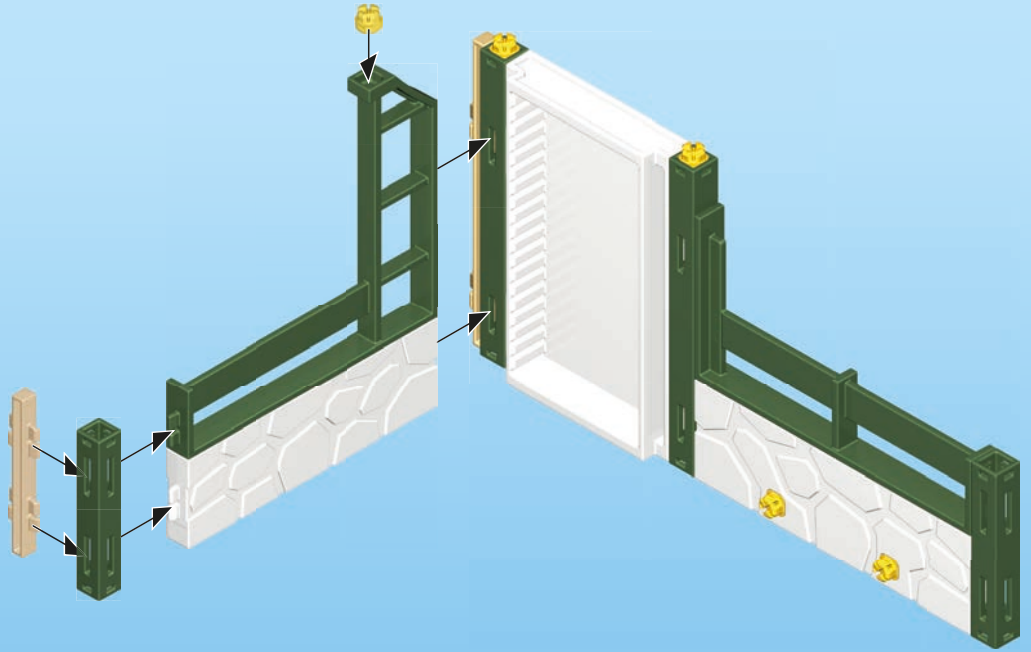
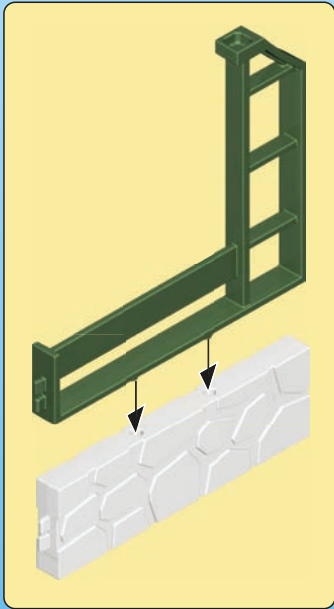

8

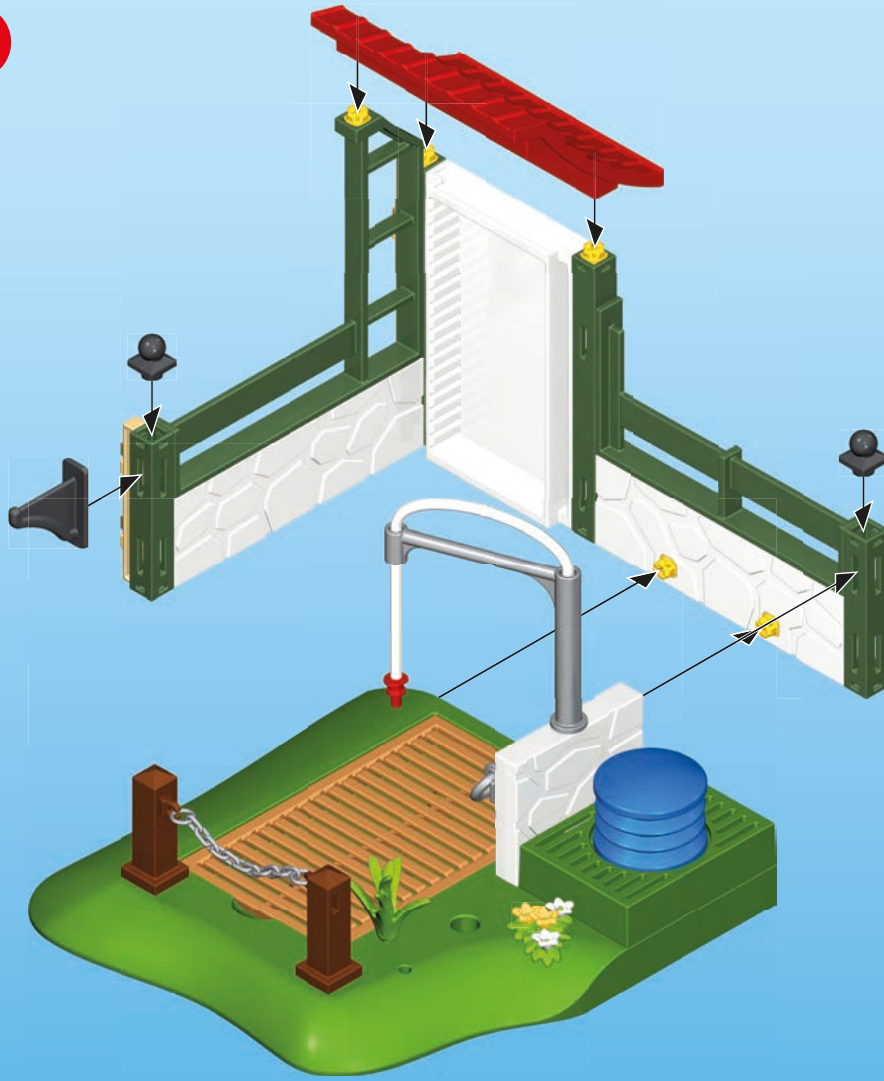

9

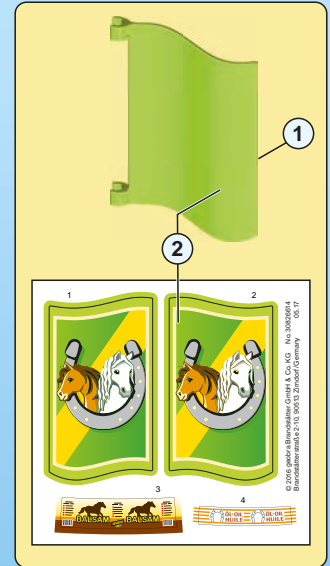

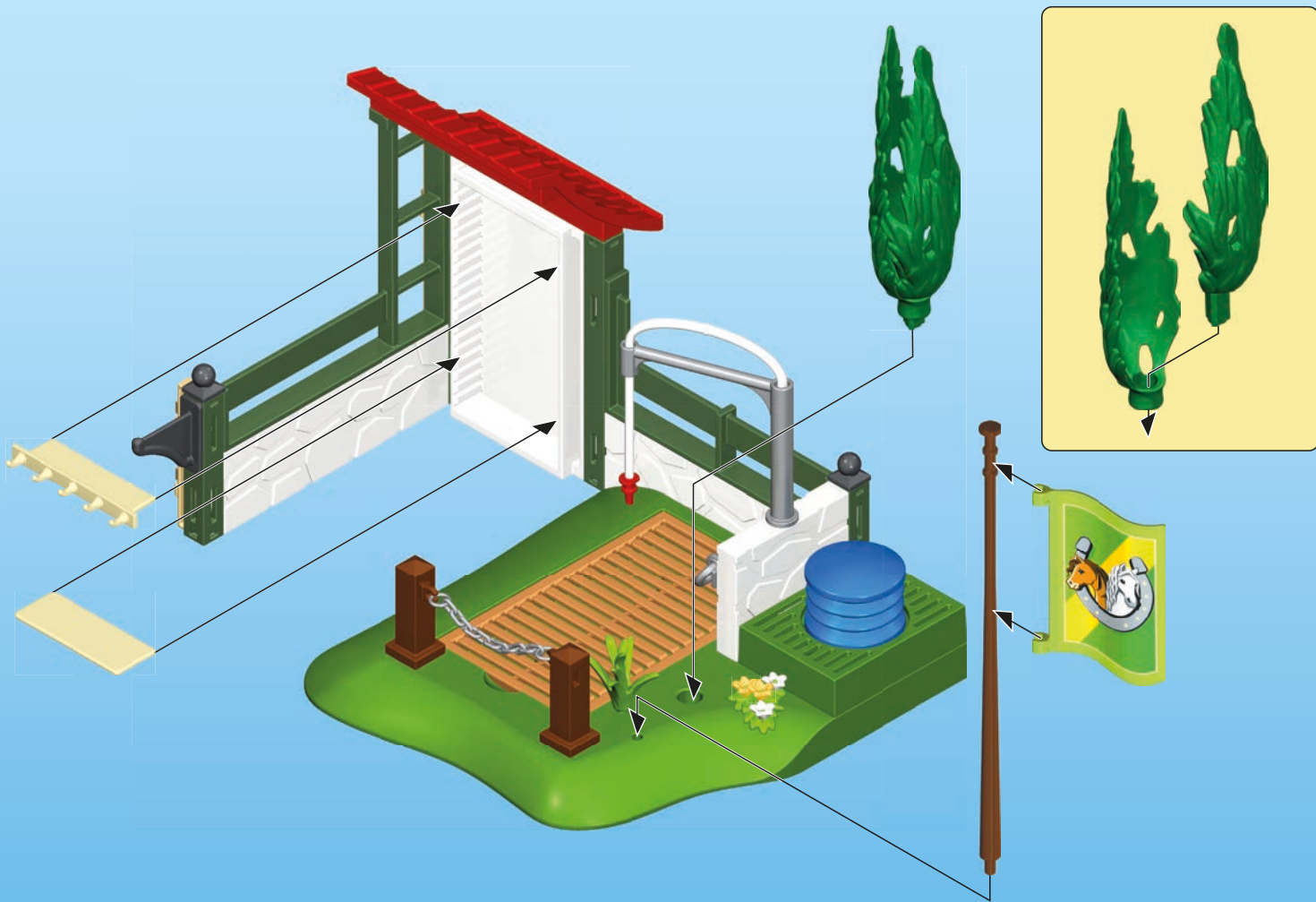



DE AT CH LU BE Nur Trinkwasser verwenden. Nach dem Spielen austrocknen lassen.

US GB CA MT IE Use only tap water. Dry thoroughly after play.

FR CA BE LU CH N'utiliser que de l'eau potable. Faire sécher après chaque utilisation.

ES MX Utilizar solamente agua potable. Dejar secar antes de guardar.

NL BE Enkel drinkbaar water gebruiken. Na het spelen laten drogen.

IT CH Usare solo acqua potabile. Asciugare bene dopo ogni uso.

PT Utilizar somente água potável. Deixar secar antes de guardar.

DK Anvend kun drikkevand. Lad det tørre ud når du er færdig med at lege.

NO Kun drikkevann skal benyttes. Tørk opp etter at leken er ferdig.

SE FI Använd endast dricksvatten. Låt torka efter användandet.

FI Käytä ainoastaan juomavettä. Anna kuivua leikin jälkeen.

HU Kérjük kizárólag ivóvizet használni! Játék után ajánlott a termék kiszáritása!

CZ Používat jen pitnou vodu. Po hraní nechat vyschnout.

EE Kasutada üksnes joogivett! Mängimise järel kuivatada!

LV Izmantot tikai dzeramo ūdeni. Pēc spēlēšanās ļaut nožūt.

LT Naudokite tik geriamąjį vandenį. Pažaidus, išdžiovinkite.

SI V igračo vlivajte le pitno vodo. Po igri naj se igrača posuši.

SK Používať iba pitnú vodu. Po hre nechat vyschnúť.

PL Używać tylko wodę pitną. Po zabawie pozostaw do wyschnięcia.

TR CY Sadece içme suyu kullanınız. Oyundan sonra kurumaya bırakın.

GR CY Χρησιμοποιείτε μόνο νερό βρύσης. Μόλις τελειώσετε, αφήστε το παιχνίδι να στεγνώσει εντελώς.

RO Se folosește doar apă potabilă. După joacă se lasă să se usuce.

BG Използвайте само питейна вода. След игра оставете да изсъхне.

HR Koristiti samo pitku vodu. Poslije igranja pustiti da se osuši.

RU Используйте только питьевую воду. Дайте высохнуть после игры.

CN 仅使用饮用水。玩耍后要干燥。



30 05 6602



30 05 6592



30 05 6582



30 80 2433

30 23 3322



30 82 2642



2x 30 89 4680



30 00 0604

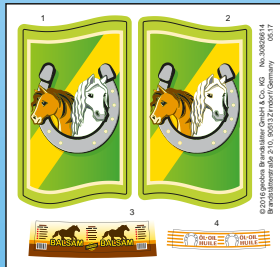

30 82 6614

© 2015 The LEGO Group. All Rights Reserved. LEGO, the LEGO logo, the Minifigure logo and other marks contained herein are trademarks of The LEGO Group. 0517



30 63 2135



30 63 5583

30 23 9382

30 88 7672

30 22 0562

2x 30 05 6742



2x 30 24 0172



30 80 6534



30 28 2500



30 05 6782



30 21 4263



30 29 9730



30 89 4940



30 24 9800



30 60 6610



30 05 6622

30 056612

30 22 2120

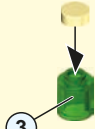

30 22 0880



30 29 0470

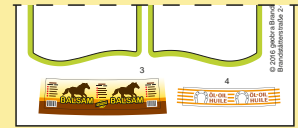

© 2015 The LEGO Group. All Rights Reserved. LEGO, the LEGO logo, the Minifigure logo and other marks contained herein are trademarks of The LEGO Group. 0517

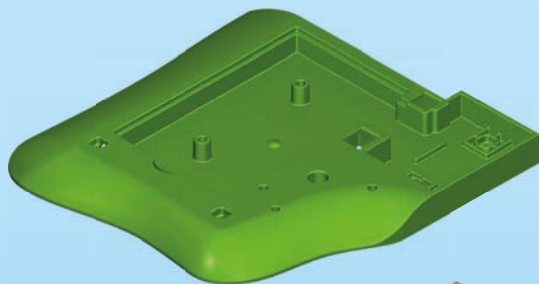

30 05 6632



30 05 6702



30 05 6662



30 05 6772



2x 30 05 6672

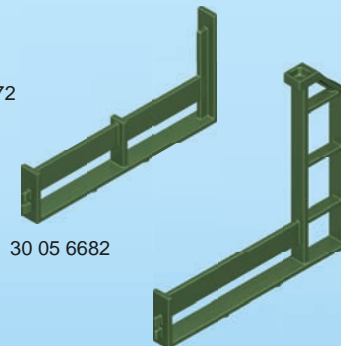

30 05 6682

30 05 6692



30 05 6712



30 05 6642

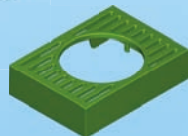

30 05 6652



30 80 6823



30 88 8852



30 27 6090



30 51 8530



30 05 6752



2x 30 05 6732



2x 30 05 6722



2x 30 05 6792



30 65 8822



30 05 6222



30 22 2740



30 27 6120

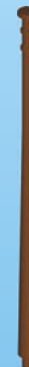

30 29 2960



5x 30 03 6600



4x 30 09 6900



30 23 0460



30 21 4793



2x 30 25 2830



2x 30 25 2810



30 51 6122

© 2017 geobra Brandstätter Stiftung & Co.KG

Brandstätterstr. 2-10

90513 Zirndorf, Germany.

No. 30 80 7864 12.20



www.playmobil.com