

# playmobil®

## 6486



**WARNING:**  
**CHOKING HAZARD**

Small parts. Not for children under 3 years.

"Ne concerne que les USA"

Wichtige Unterlagen, bitte sorgfältig aufbewahren!  
Important: Please keep these instructions for future reference!  
Documents importants, à conserver soigneusement!  
Belangrijke documenten, bewaar deze zorgvuldig!



**5159**  
**7350**

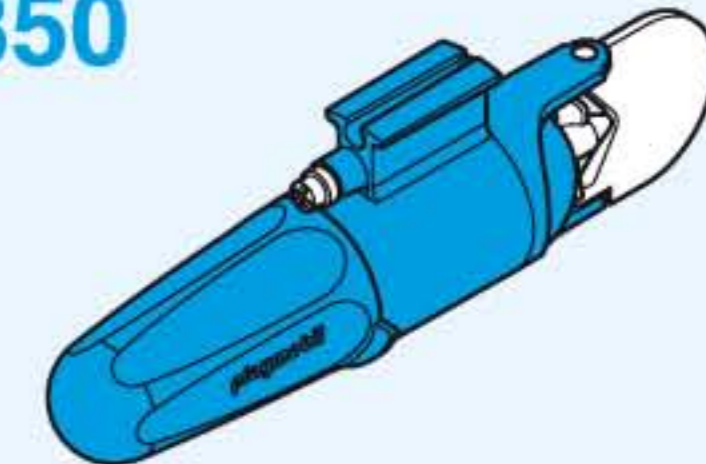

- Nachrüstbar mit Unterwassermotor
- Compatible with the underwater motor (sold separately)
- Monteur submersible, vendu séparément, s'adapte sur ce bateau

Serviceadressen finden Sie in allen Playmobil-Prospekten

Addresses of Customer Service Departments are shown in all Playmobil catalogues

L'adresse du service consommateurs est indiquée dans tous les catalogues Playmobil

Troverete gli indirizzi dei centri di assistenza in tutti i cataloghi Playmobil

In alle PLAYMOBIL catalogi vindt u het adres van onze klantendienst.

Las Direcciones de los Departamentos de Servicio al Consumidor se encuentran en todos los catálogos Playmobil

Η διεύθυνση του Γραφείου Εξυπηρέτησης Καταναλωτών PLAYMOBIL βρίσκεται σε όλους τους καταλόγους PLAYMOBIL.

pronounce: plāy-mō-bēēl

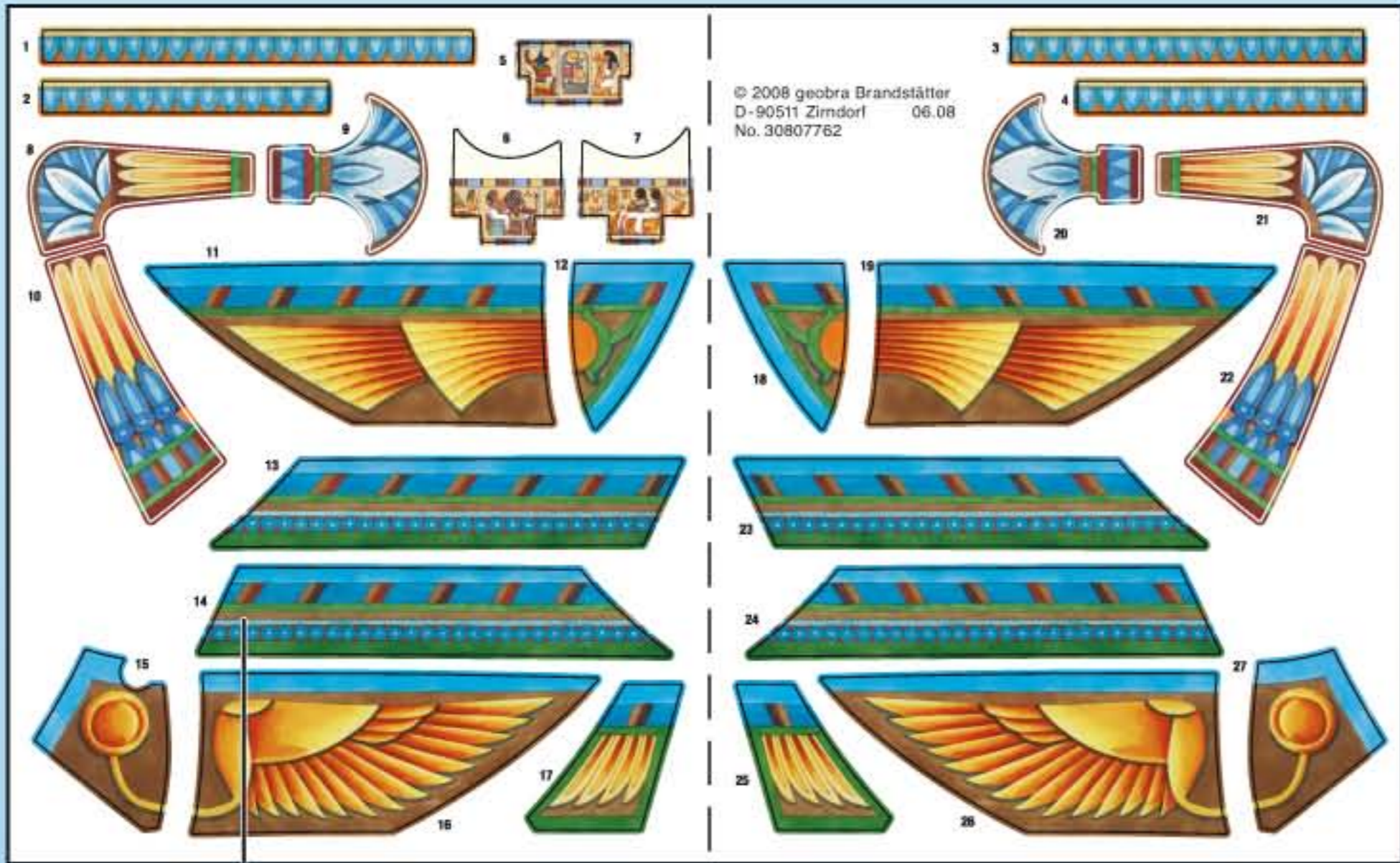

1

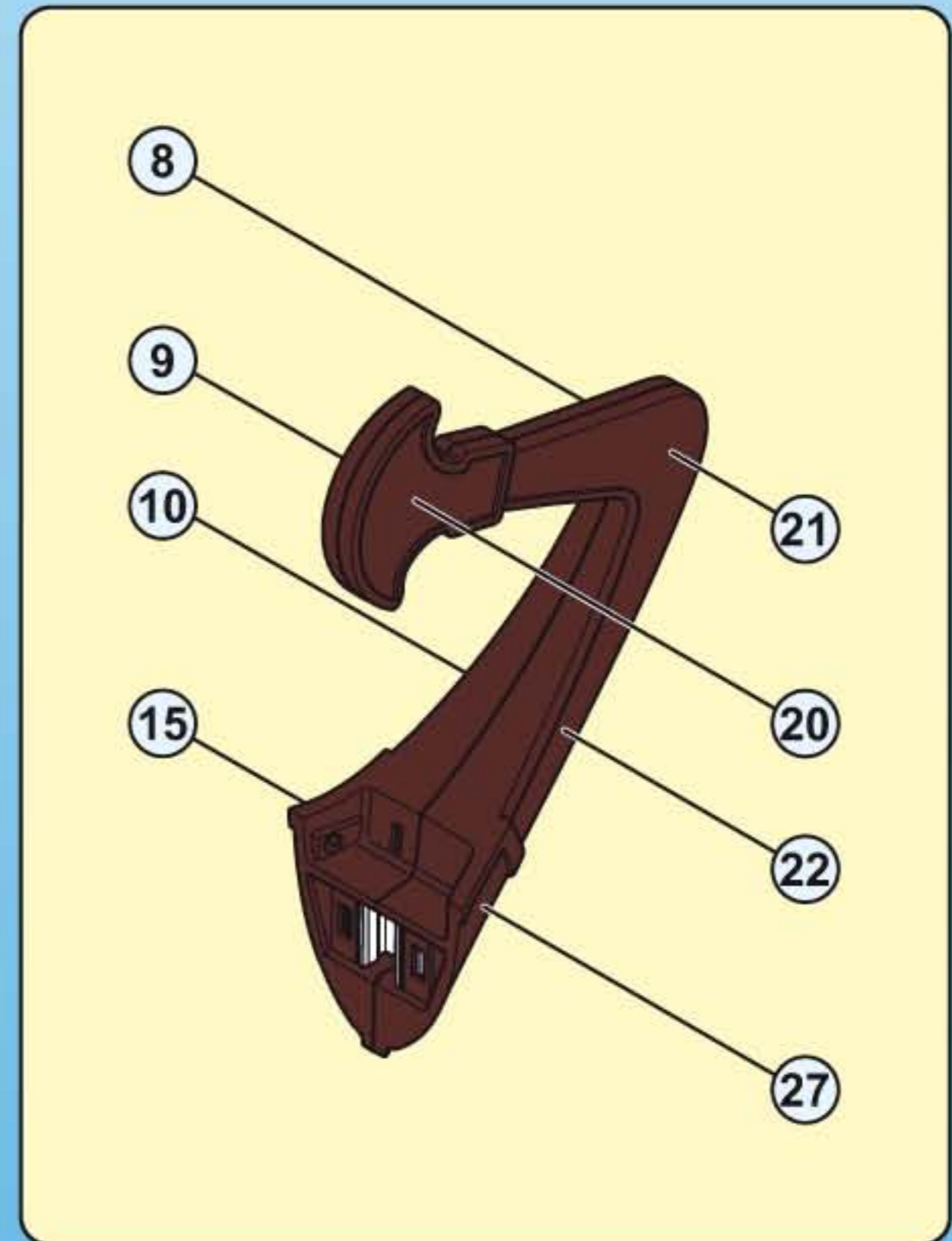
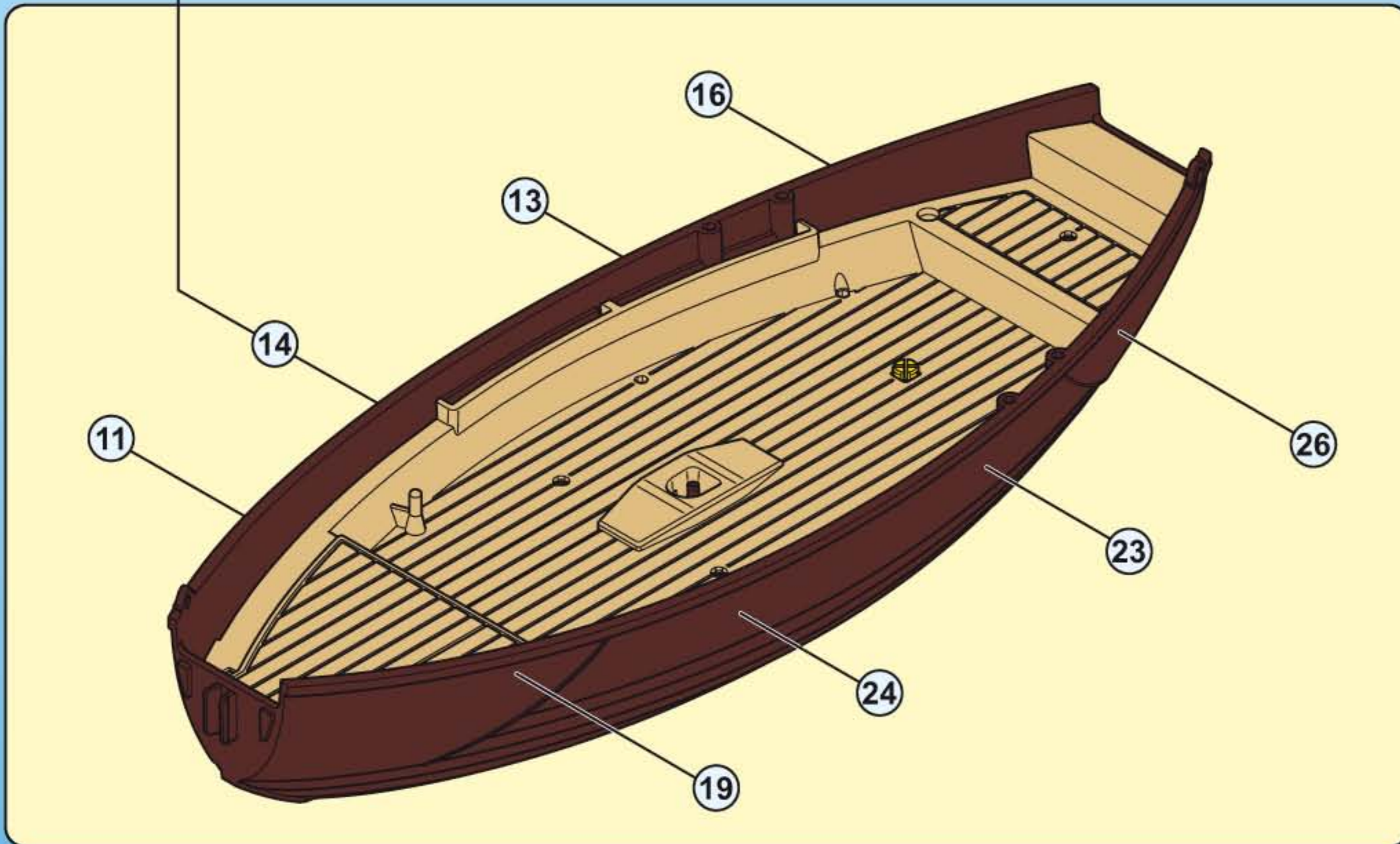
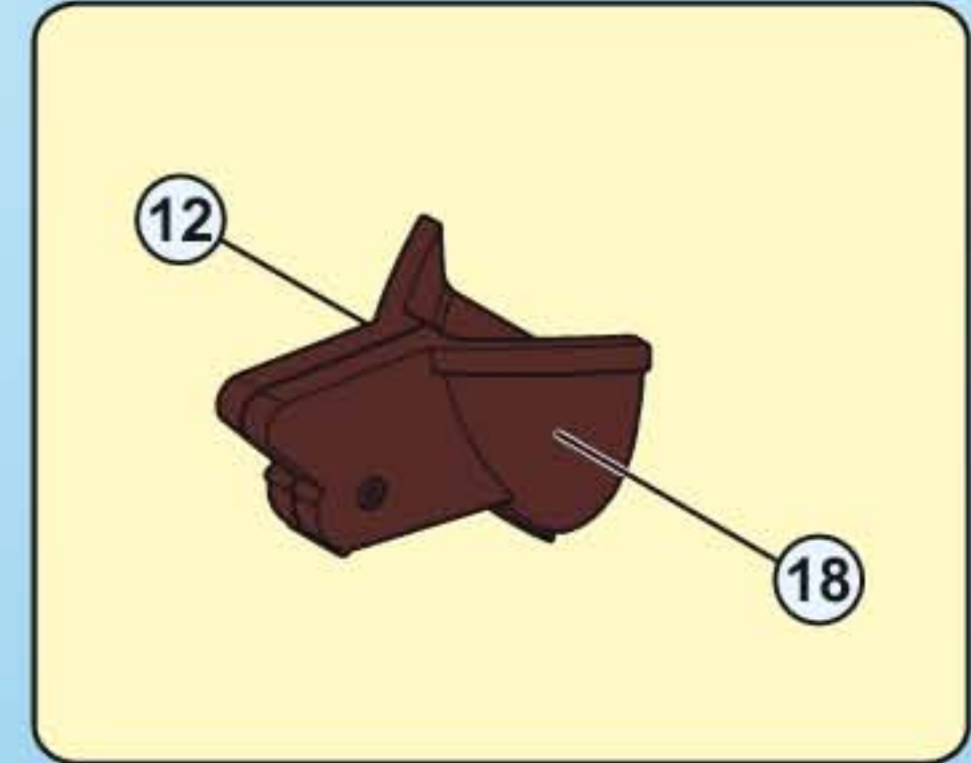
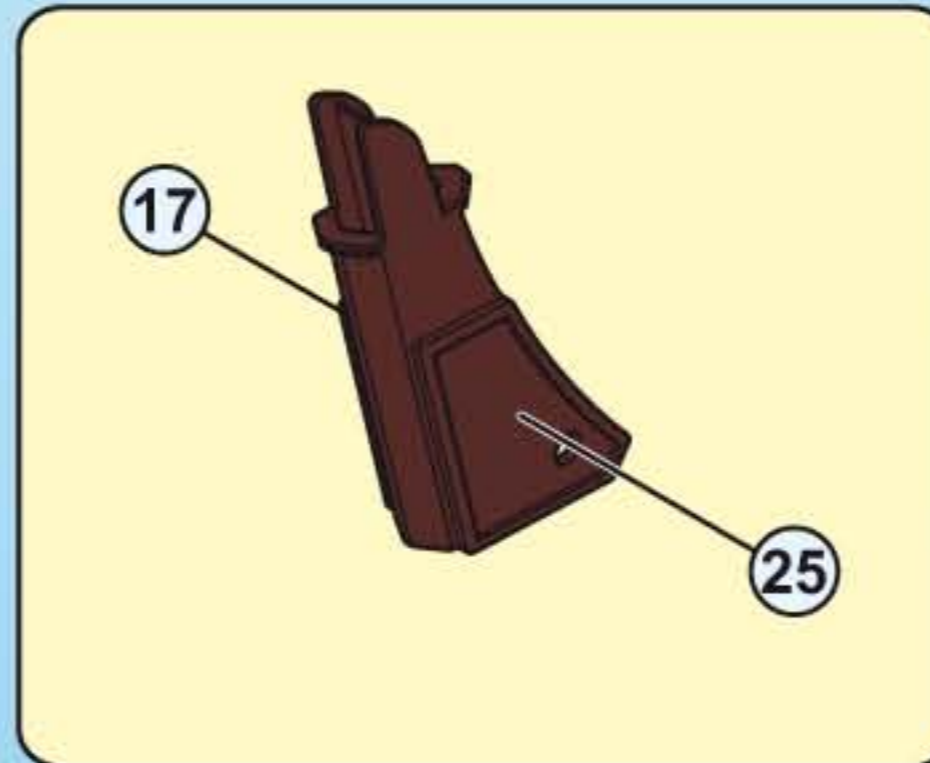

2

2

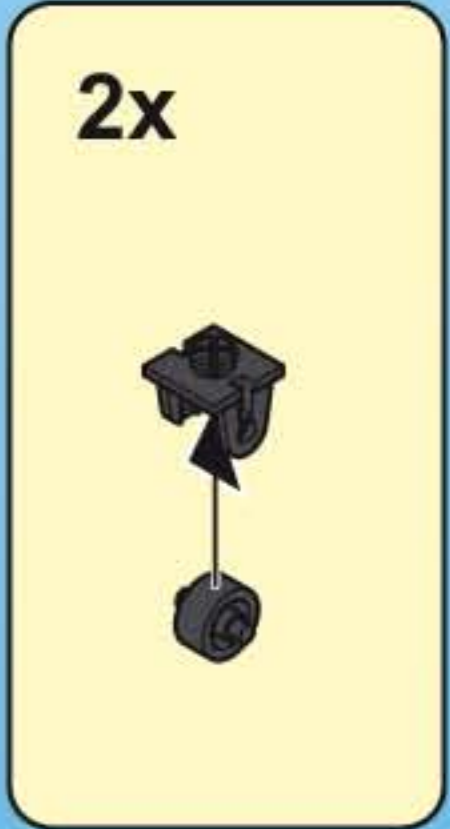
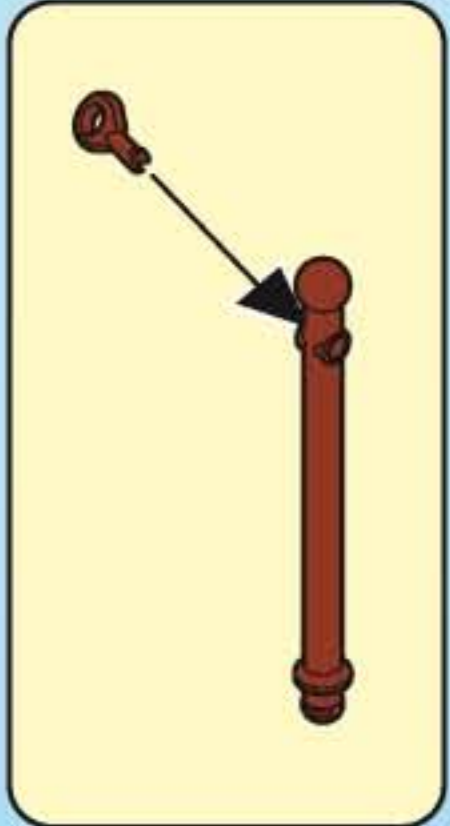
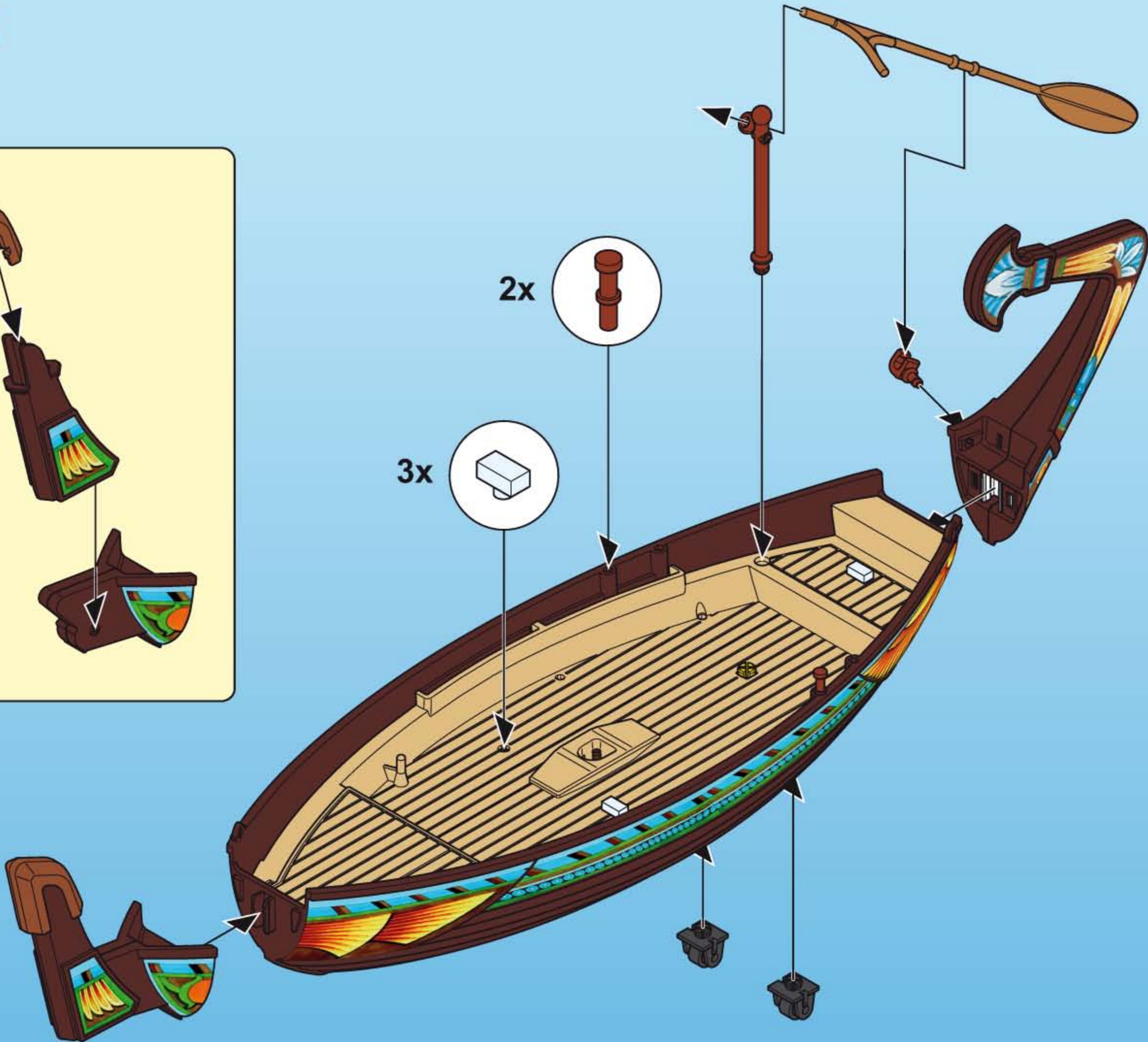

3

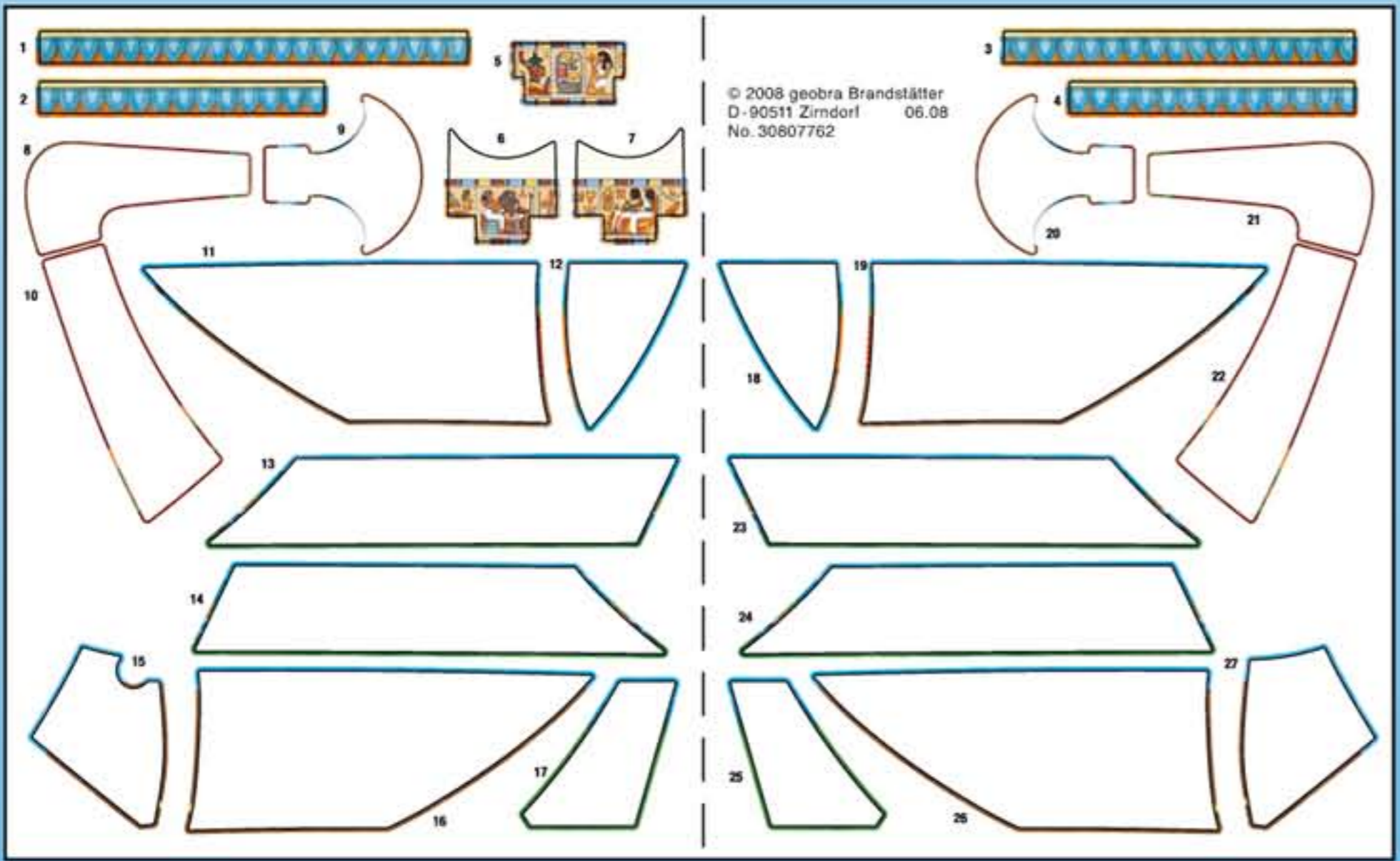
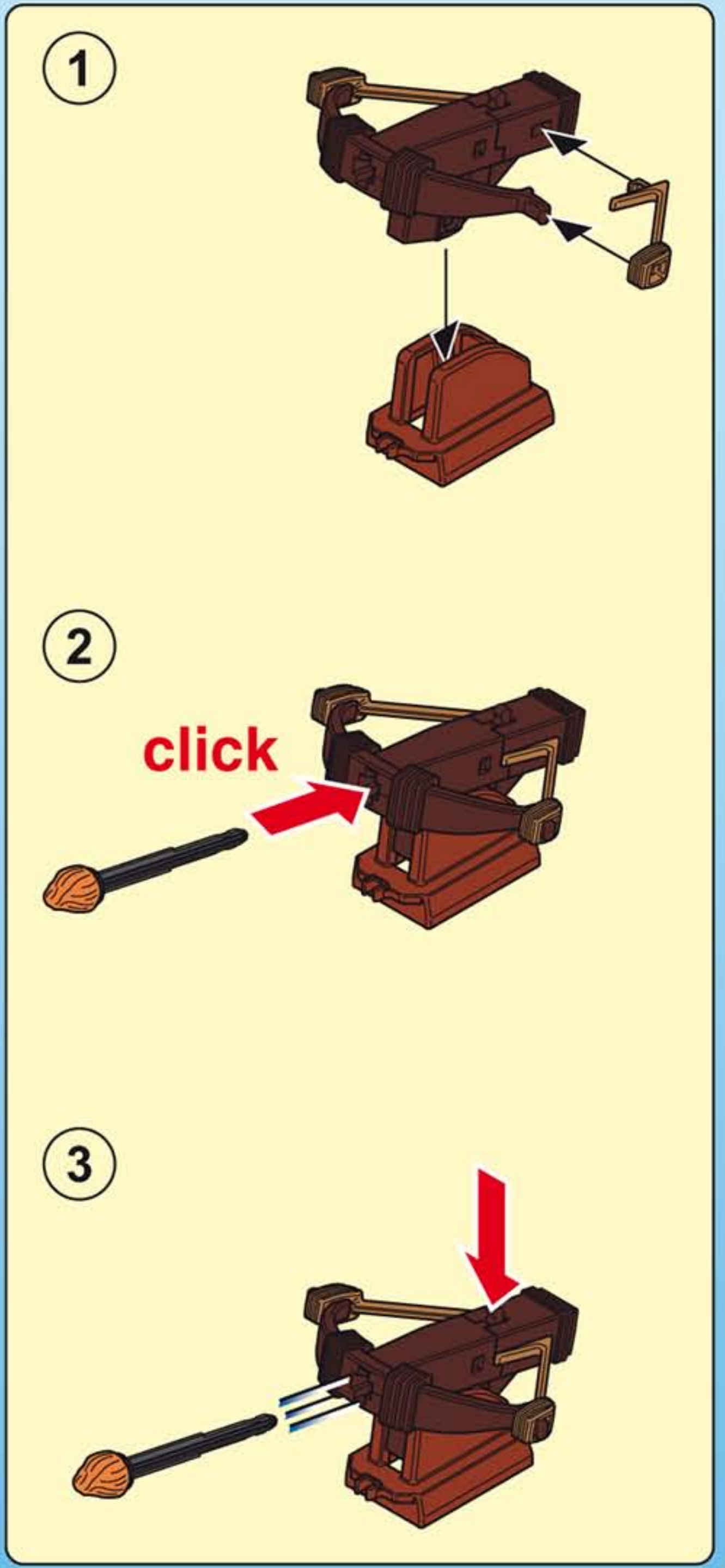
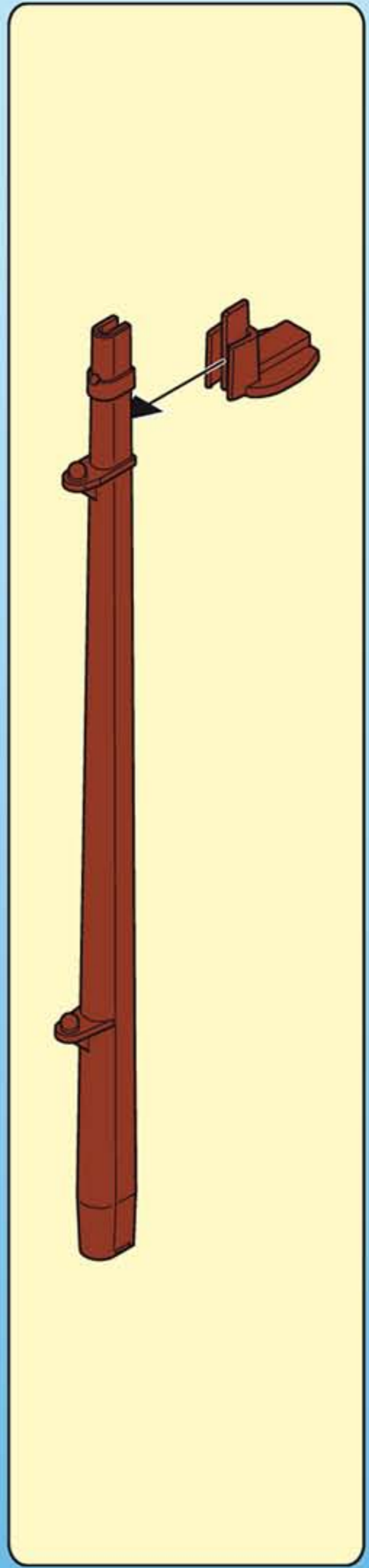
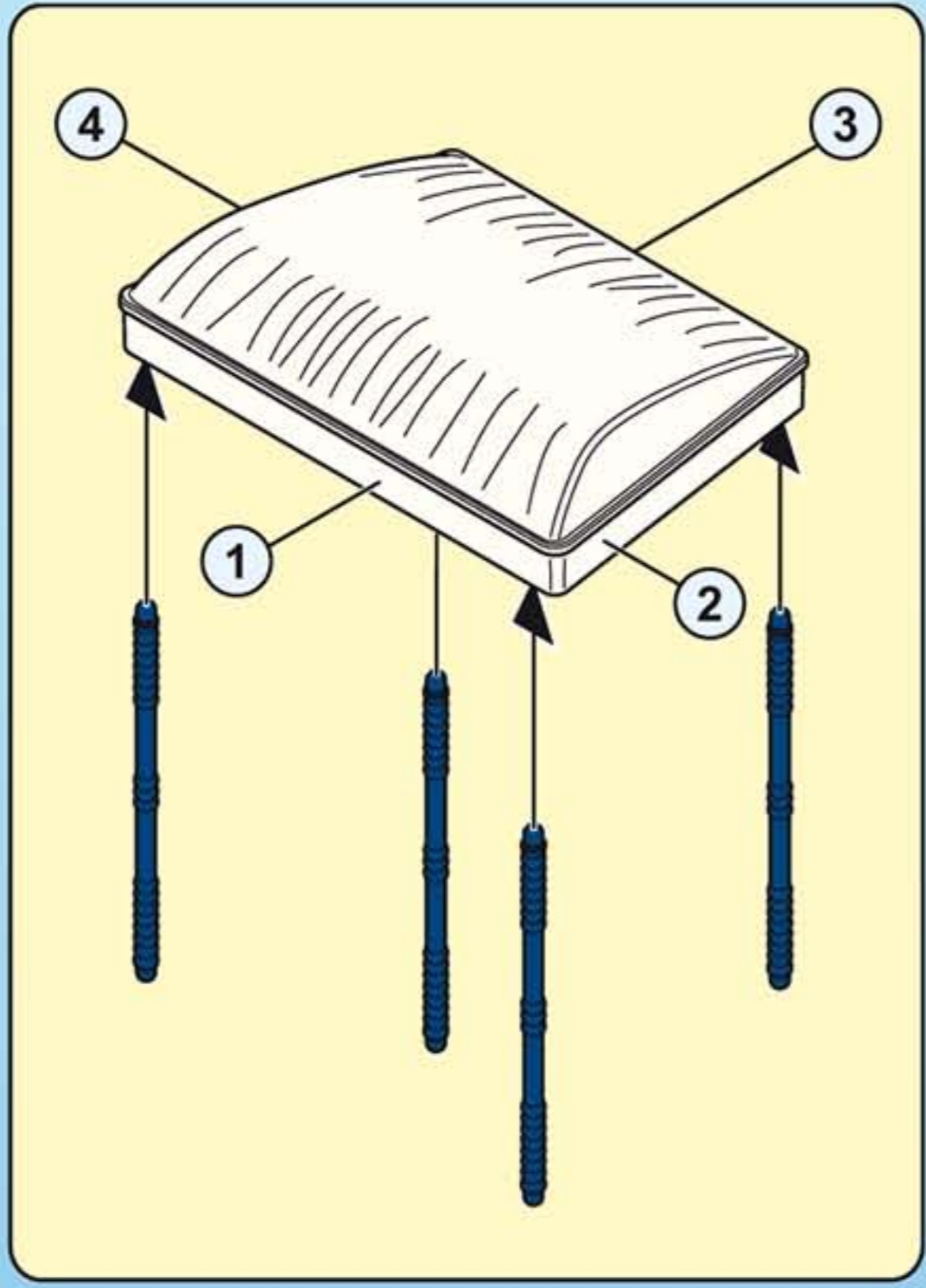
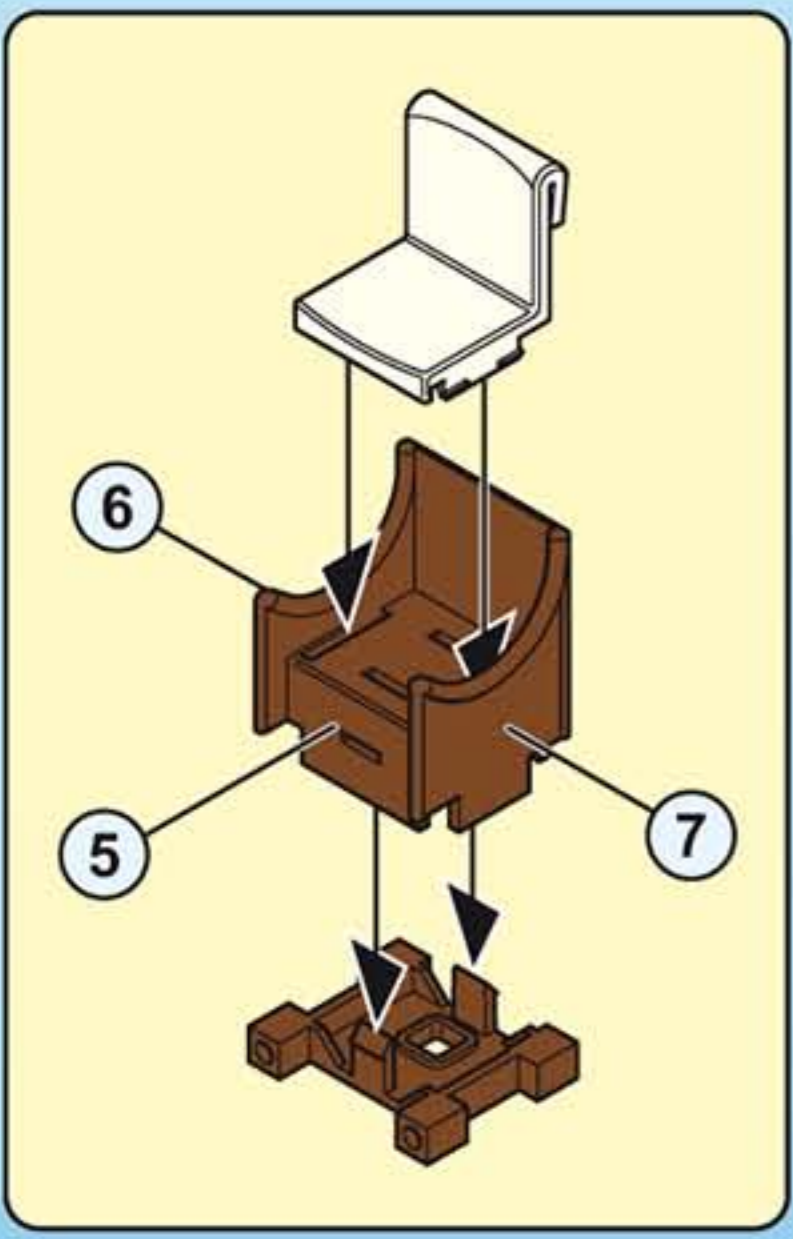

**(D) (A) (CH) (L) (B) ACHTUNG!** Nur mitgelieferte PLAYMOBIL Geschosse verwenden. Nicht auf Augen oder Gesicht zielen.

**(USA) (GB) (CDN) (M) (IRL) WARNING!** Only use the PLAYMOBIL projectiles supplied. Do not aim at eyes or face.

**(F) (CDN) (B) (L) (CH) ATTENTION!** Seulement utiliser les projectiles PLAYMOBIL fournis. Ne pas viser les yeux ou le visage.

**(E) (MEX) ¡ADVERTENCIA!** Utiliza únicamente los proyectiles PLAYMOBIL suministrados. No apuntar a los ojos ni a la cara.

**(NL) (B) WAARSCHUWING!** Uitsluitend meegeleverde PLAYMOBIL delen gebruiken. Niet op ogen of gezicht richten.

**(I) (CH) AVVERTENZA!** Usare soltanto i proiettili PLAYMOBIL in dotazione. Non mirare agli occhi o al viso.

**(P) ATENÇÃO!** Usar apenas os projecteis PLAYMOBIL juntamente fornecidos. Não apontar para os olhos ou face.

**(DK) ADVARSEL!** Anvend kun de medfølgende PLAYMOBIL projektiler. Sigt ikke mod øjne eller ansigt.

**(N) ADVARSEL!** Benytt kun PLAYMOBIL prosjektil som leveres med. Sikt ikke på ansikt eller øyne.

**(S) (FIN) VARNING!** Använd endast medlevererade PLAYMOBIL-skott. Ei saa kohdistaa suoraan silmiin tai kasvoihin.

**(FIN) VAROITUS!** Käytä vain mukana toimitettuja PLAYMOBIL-ammuksia. Älä tähtää päin silmiä tai kasvoja.

**(H) FIGYELMEZTETÉS.** Csak a csomagban található PLAYMOBIL lövedékeket szabad használni. Tilos szemre vagy arcra célozni.

**(CZ) UPOZORNĚNÍ!** Používejte pouze střely PLAYMOBIL, které jsou součástí dodávky. Nemiřte na oči nebo na obličej!

**(EST) HOIATUS!** Kasutage ainult kaasaantud PLAYMOBIL'i laskemoona. Ära sihi silmadesse ega näkku.

**(LV) BRĪDINĀJUMS!** Izmantot tikai PLAYMOBIL piegādes komplektā iekļautos šāviņus. Nevērst pret acīm vai seju.

**(LT) ĮSPĖJIMAS!** Naudokite tik pridedamus PLAYMOBIL šaudmenis. Netaikyti į akis arba veidą.

**(SLO) OPOZORILO!** Uporabljajte le priložene PLAYMOBIL-ove krogle. Ne merite v oči ali obraz.

**(SK) UPOZORNENIE!** Používajte len náboje dodávané spolu so sadou PLAYMOBIL. Nemieriť do očí alebo do tváre.

**(PL) OSTRZEŻENIE!** Stosować tylko załączone PLAYMOBIL - kule / pociski. Nie celować w oczy i twarz.

**(TR) (CY) DİKKAT!** Sadece birlikte verilen PLAYMOBIL mermileri kullanınız. Göze veya yüze doğru tutmayınız.

**(GR) (CY) Προειδοποίηση!** Να χρησιμοποιούνται αποκλειστικά τα βλήματα της PLAYMOBIL που περιέχονται στη συσκευασία. Μη μην γίνεται στόχευση στα μάτια ή στο πρόσωπο.

**(RO) AVERTISMENT!** Se folosesc doar proiectilele incluse PLAYMOBIL. Nu se țintește în ochi sau în față.

**(BG) Внимание!** Използвайте само приложени PLAYMOBIL снаряди. Не насочвайте към очите и лицето.

**(HR) UPOZORENJE!** Upotrijebiti samo od strane PLAYMOBIL-a isporučene projekte. Ne ciljati u oči ili lice.

**(CN) 警告!** 仅能用PLAYMOBIL的炮弹。禁止瞄准眼睛或脸。请勿瞄准眼睛或脸。

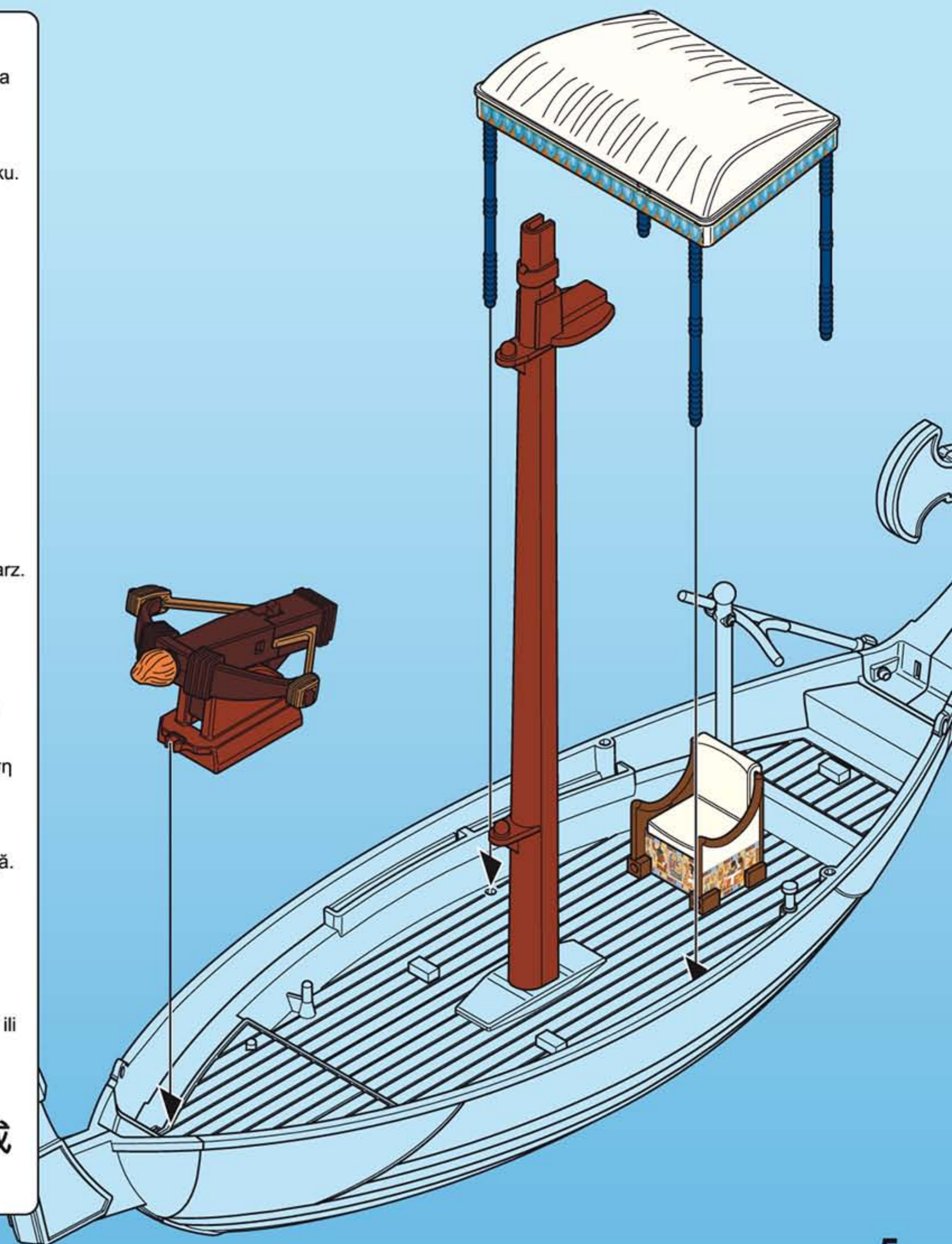

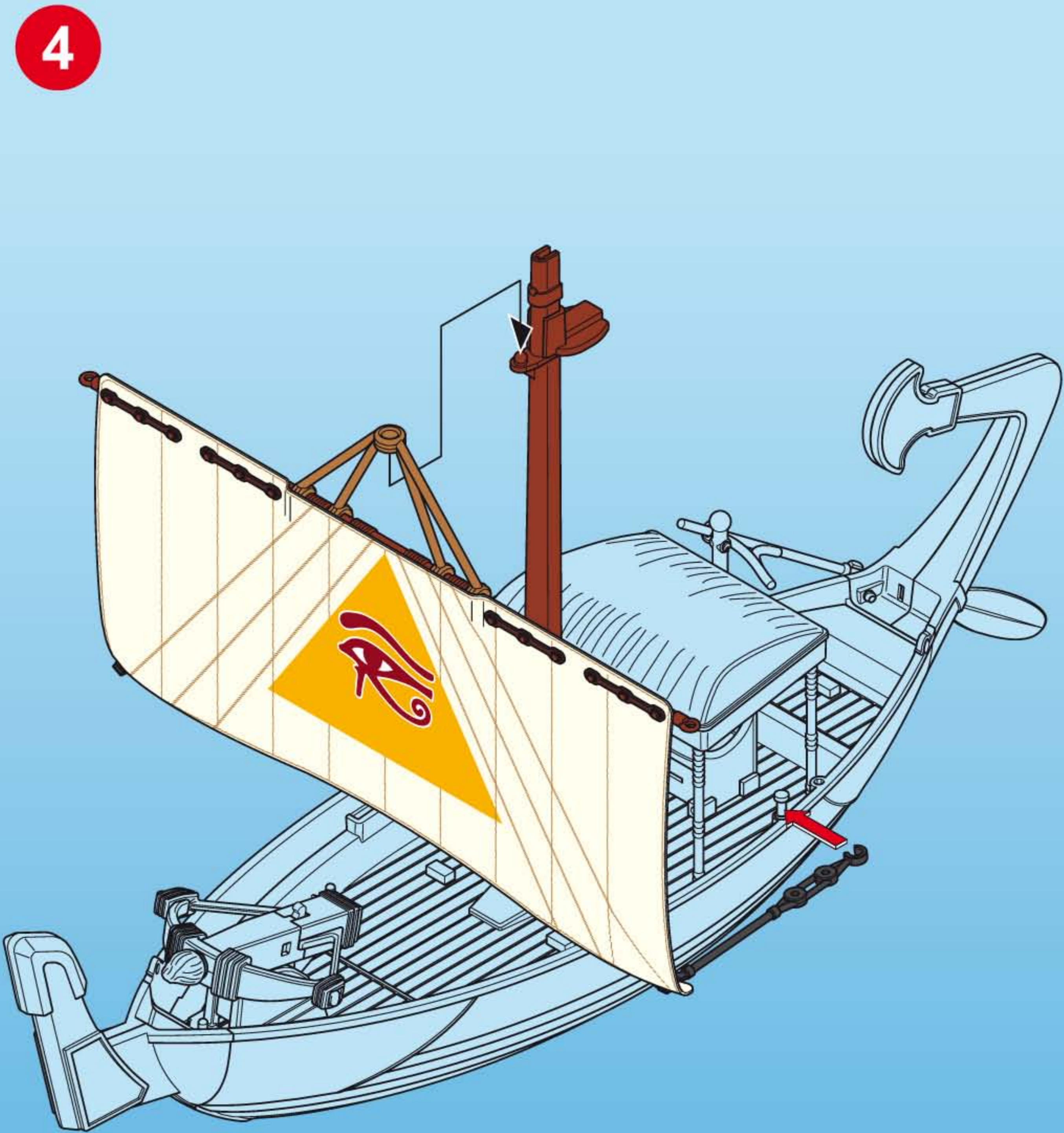
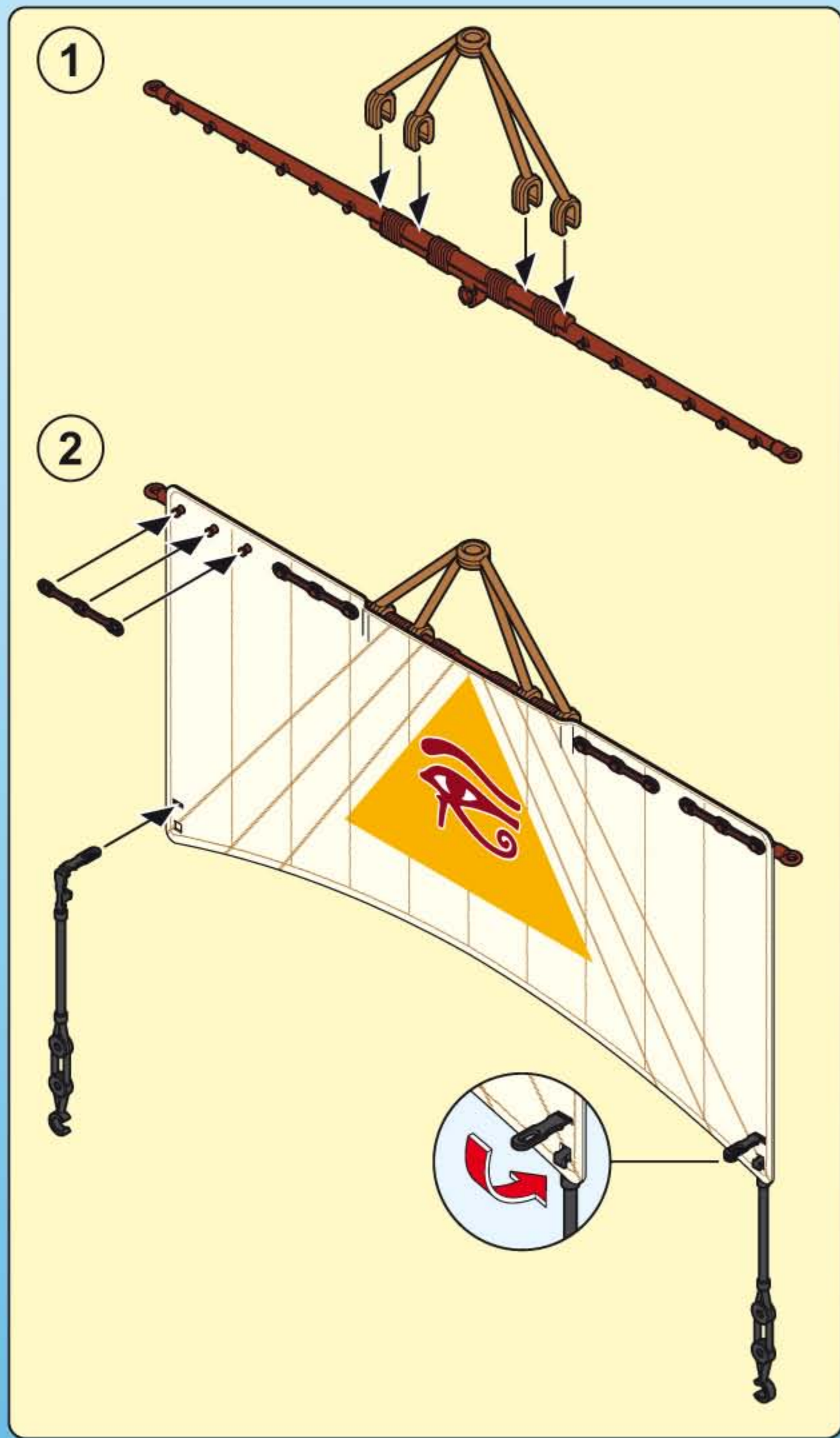



30 29 3900



30 29 3930

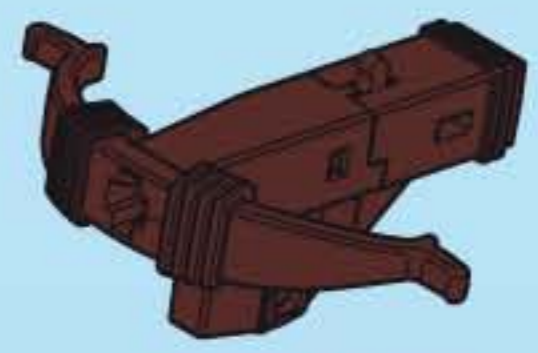

30 65 5692



30 25 9573



8x 30 62 0985

30 80 7752



30 65 5682

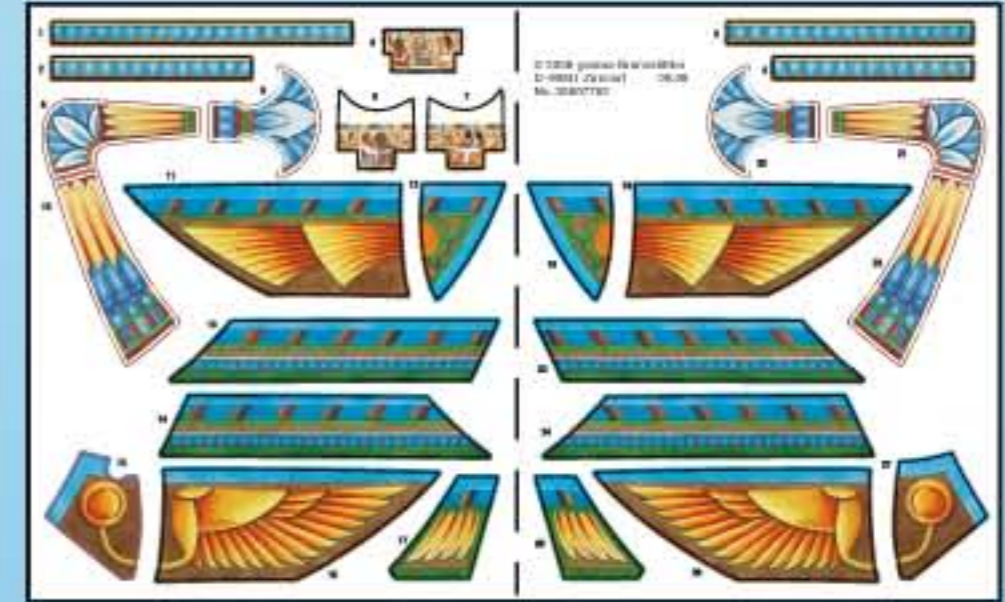

30 80 7762



30 29 3810



2x 30 23 3812



4x 30 04 3652



30 29 3890

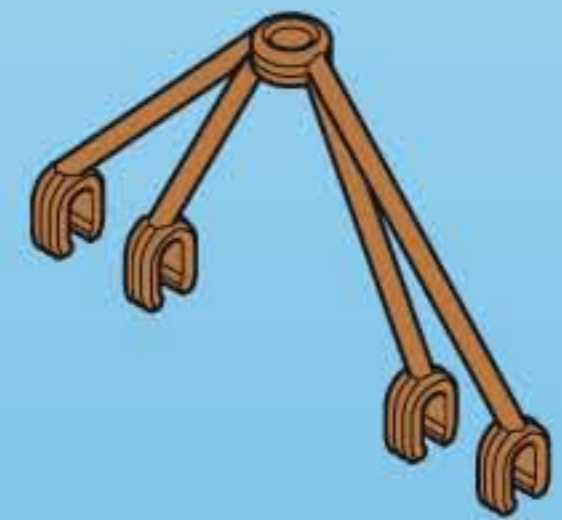

30 29 3880



30 29 3790



2x 30 29 3940



30 29 3800



30 29 2980



30 29 3860



30 29 3830



30 65 5672



30 51 5810



30 61 9630



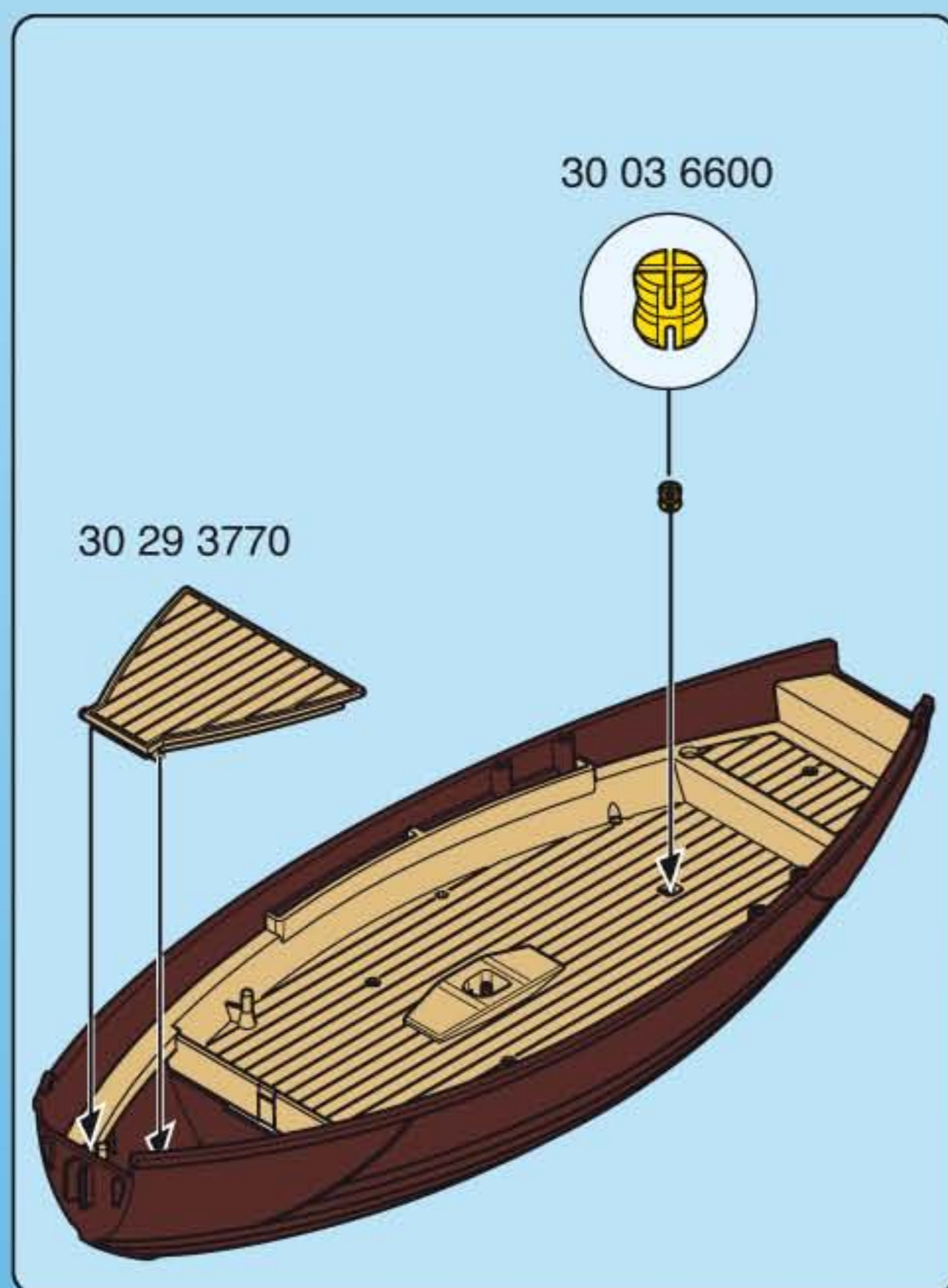

**(D) (A) (CH) (L) (B) ACHTUNG!**

- Nur im flachen Wasser unter Aufsicht von Erwachsenen verwenden. Nach dem Spielen austrocknen lassen.

**(USA) (GB) (CDN) (M) (IRL) WARNING!**

- Only to be used in water in which the child is within its depth and under adult supervision. Dry thoroughly after play.

**(F) (CDN) (B) (L) (CH) ATTENTION!**

- À n'utiliser qu'en eau où l'enfant a pied et sous la surveillance d'un adulte. Faire sécher après chaque utilisation.

**(E) (MEX) ¡ADVERTENCIA!**

- Utilizar sólo en agua donde el niño pueda permanecer de pie y bajo vigilancia de un adulto. Dejar secar antes de guardar.

**(NL) (B) WAARSCHUWING!**

- Gebruiken in water waar kinderen kunnen staan en onder toezicht van volwassenen. Na het spelen laten drogen.

**(I) (CH) AVVERTENZA!**

- Da utilizzare unicamente in acqua dove il bambino tocca il fondo con i piedi e sotto la sorveglianza di un adulto. Asciugare bene dopo ogni uso.

**(P) ATENÇÃO!**

- Só utilizar em água onde a criança tenha pé e sob vigilância de adultos. Deixar secar antes de guardar.

**(DK) ADVARSEL!**

- Må kun anvendes under opsyn af en voksen og på vanddybder, hvor barnet kan bunde. Lad det tørre ud når du er færdig med at lege.

**(N) ADVARSEL!**

- Skal kun brukes i vann som ikke er for dypt for barnet, og der barnet er under tilsyn. Tørk opp etter at leken er ferdig.

**(S) (FIN) VARNING!**

- Får endast användas i vatten där barnet bottnar och under tillsyn av en vuxen. Låt torka efter användandet.

**(FIN) VAROITUS!**

- Käytävä vain aikuisen valvonnassa vedessä, jossa lapsi ylettyy pohjaan. Anna kuivua leikin jälkeen.

**(H) FIGYELMEZTETÉS.**

- Csak a gyermek magasságához képest biztonságos sekély vízben és felnőtt felügyelete mellett szabad használni! Játék után ajánlott a termék kiszáritása!

**(CZ) UPOZORNĚNÍ!**

- Používat pouze ve vodě takové hloubky, kde dítě stačí, a pouze pod dohledem dospělé osoby. Po hraní nechat vyschnout.

**(EST) HOIATUS!**

- Kasutada ainult täiskasvanu järelevalve all vees, kus laps ulatub jalgadega põhja. Mängimise järel kuivatada!

**(LV) BRĪDINĀJUMS!**

- Lietot tikai seklā ūdenī un pieaugušo uzraudzībā. Pēc spēlēšanās ļaut nožūt.

**(LT) ĮSPĖJIMAS!**

- Naudoti tik vaikui tinkamame gylyje ir prižiūrint suaugusiesiems. Pažaidus, išdžiovinkite.

**(SLO) OPOZORILO!**

- Uporabljajte samo v vodi, primerno plitvi za otroka in pod nadzorom odrasle osebe. Po igri naj se igrača posuši.

**(SK) UPOZORNENIE!**

- Používať len vo vode, v ktorej dieťa dočiahne na dno, a pod dohľadom dospelej osoby. Po hre nechať vyschnúť.

**(PL) OSTRZEŻENIE!**

- Do używania jedynie w wodzie na głębokości, na której dziecko wyczuwa dno pod nogami oraz pod nadzorem osoby dorosłej. Po zabawie pozostaw do wyschnięcia.

**(TR) (CY) DİKKAT!**

- Sadece denetim altında ve sadece alçak sularda kullanın. Oyundan sonra kurumaya bırakın.

**(GR) (CY) Προειδοποίηση!**

- Να χρησιμοποιείται μόνο σε νερά όπου πατώνει το παιδί και υπό την επίβλεψη ενηλίκου. Μόλις τελειώσετε, αφήστε το παιχνίδι να στεγνώσει εντελώς.

**(RO) AVERTISMENT!**

- A se utiliza numai acolo unde copilul poate sta în picioare în apă și este sub supraveghere. După joacă se lasă să se usuce.

**(BG) Внимание!**

- Да се използва само във вода, която е дълбока до нормалния ръст на детето, и под надзора на възрастен. След игра оставете да изсъхне.

**(HR) UPOZORENJE!**

- Koristiti samo u plitkoj vodi pod nadzorom odraslih. Poslije igranja pustiti da se osuši.

**(CN) 警告!**

- 可供孩子在水中使用，但必须在有人监护的情况下。玩耍后要干燥。

