

playmobil®

6146



WARNING:
CHOKING HAZARD

Small parts. Not for children under 3 years.

”Ne concerne que les USA“

Wichtige Unterlagen, bitte sorgfältig aufbewahren !
Important: Please keep these instructions for future reference !
Documents importants, à conserver soigneusement !
Belangrijke documenten, bewaar deze zorgvuldig !



1

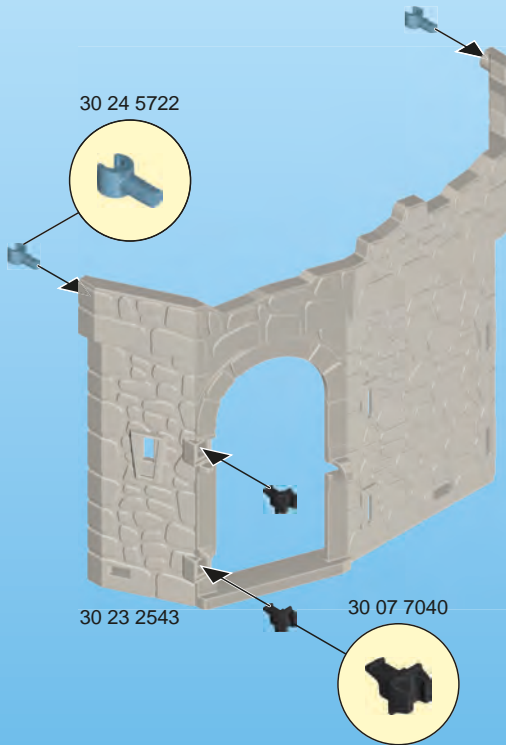

2

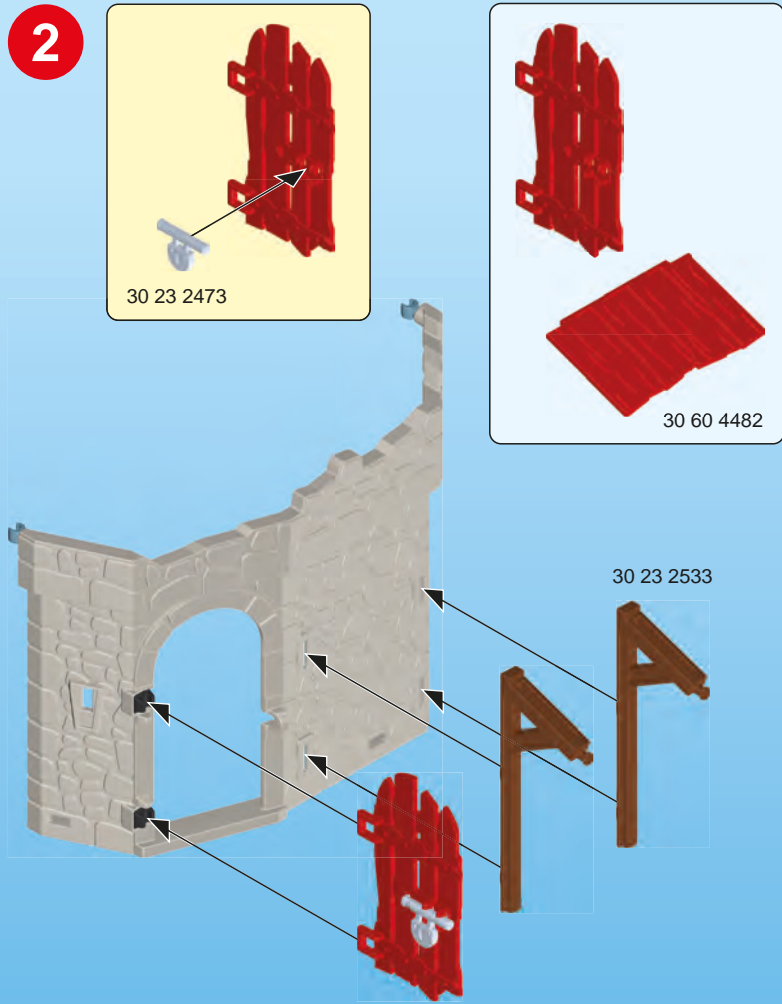

3



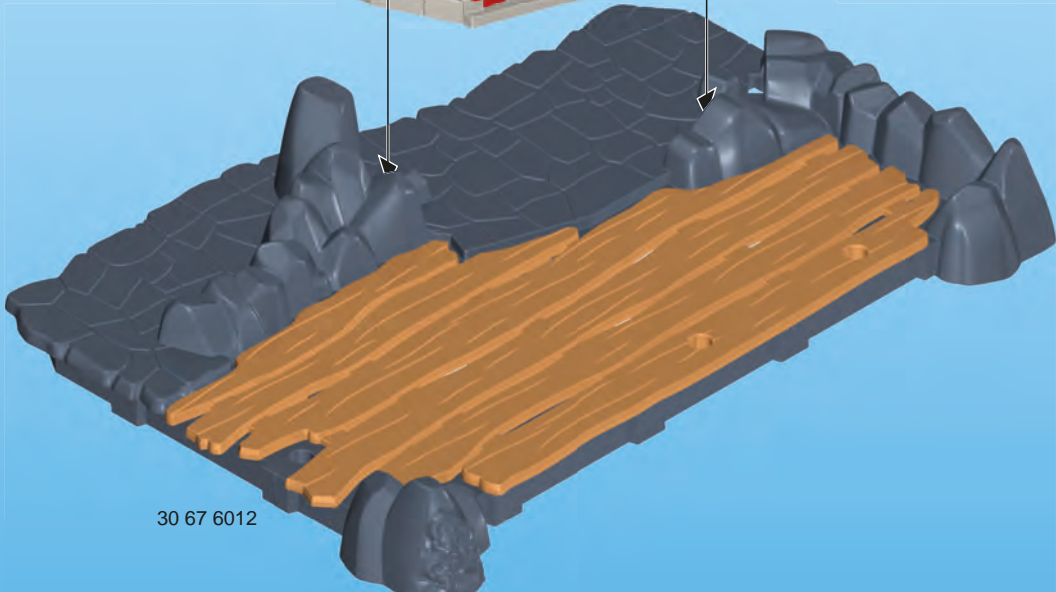
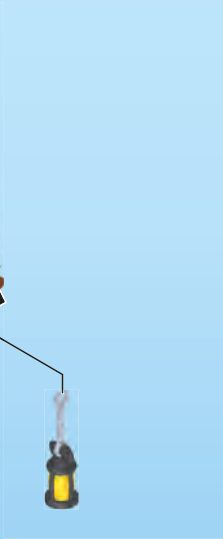

30 24 7510



30 67 6012

4

2x
30 23 2493

30 23 2523

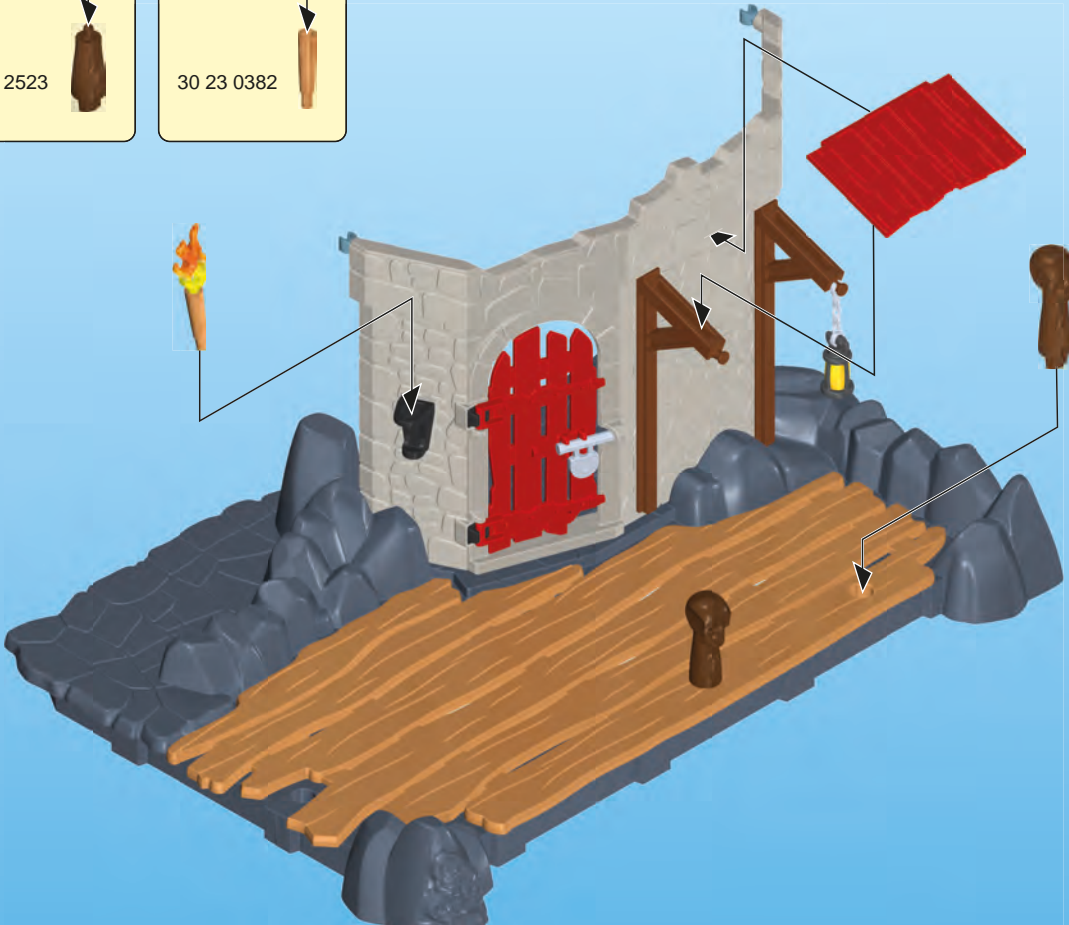
30 25 6163

30 23 0382

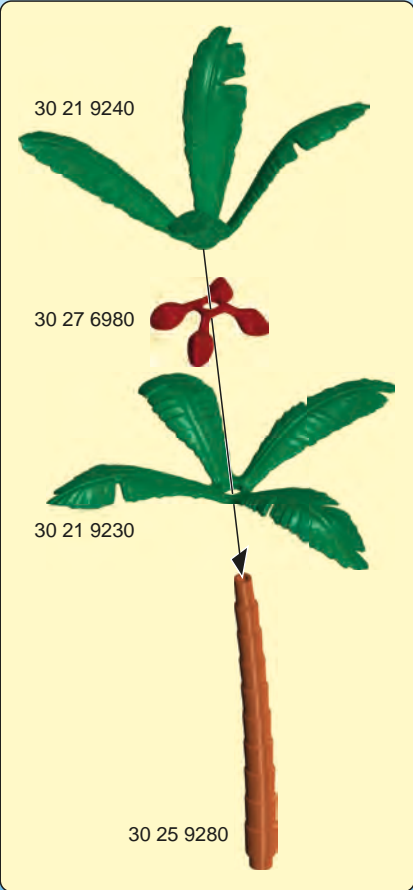
5



1

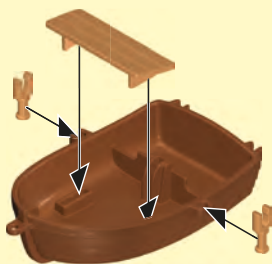

30 23 2453

30 20 5152

2



30 88 3540



30 51 9780

(DE) **(AT)** **(CH)** **(LU)** **(BE)** **ACHTUNG!** Nur im flachen Wasser unter Aufsicht von Erwachsenen verwenden.

(US) **(GB)** **(CA)** **(MT)** **(IE)** **WARNING!** Only to be used in water in which the child is within its depth and under adult supervision.

(FR) **(CA)** **(BE)** **(LU)** **(CH)** **ATTENTION!** À n'utiliser qu'en eau où l'enfant a pied et sous la surveillance d'un adulte.

(ES) **(MX)** **¡ADVERTENCIA!** Utilizar sólo en agua donde el niño pueda permanecer de pie y bajo vigilancia de un adulto.

(NL) **(BE)** **WAARSCHUWING!** Gebruiken in water waar kinderen kunnen staan en onder toezicht van volwassenen.

(IT) **(CH)** **AVVERTENZA!** Da utilizzare unicamente in acqua dove il bambino tocca il fondo con i piedi e sotto la sorveglianza di un adulto.

(PT) **ATENÇÃO!** Só utilizar em água onde a criança tenha pé e sob vigilância de adultos.

(DK) **ADVARSEL!** Må kun anvendes under opsyn af en voksen og på vanddybder, hvor barnet kan bunde.

(NO) **ADVARSEL!** Skal kun brukes i vann som ikke er for dypt for barnet, og der barnet er under tilsyn.

(SE) **(FI)** **VARNING!** Får endast användas i vatten där barnet bottnar och under tillsyn av en vuxen.

(FI) **VAROITUS!** Lelua saa käytää vain aikuisen valvonnassa vedessä, jossa lapsi ylettyy pohjaan.

(HU) **FIGYELMEZTETÉS!** Csak a gyermek magasságához képest biztonságos sekély vízben és felnőtt felügyelete mellett szabad használni!

(CZ) **UPOZORNĚNÍ!** Používat pouze ve vodě takové hloubky, kde dítě stačí, a pouze pod dohledem dospělé osoby.

(EE) **HOIATUS!** Kasutada ainult täiskasvanu järelevalve all vees, kus laps ulatub jalgadega põhja.

(LV) **BRĪDINĀJUMS!** Lietot tikai sekļā ūdenī un pieaugušo uzraudzībā.

(LT) **ISPĖJIMAS!** Naudoti tik vaikui tinkamame gylyje ir prižiūrint suaugusiesiems.

(SI) **OPOZORILO!** Uporabljajte samo v vodi, primerno plitvi za otroka in pod nadzorom odrasle osebe.

(SK) **UPOZORNENIE!** Používať len vo vode, v ktorej dieťa dočiahne na dno, a pod dohľadom dospelých osoby.

(PL) **OSTRZEŻENIE!** Do używania jedynie w wodzie na głębokości, na której dziecko wyczuwa dno pod nogami oraz pod nadzorem osoby dorosłej.

(TR) **(CY)** **ΔΙΚΚΑΤ!** Sadece denetim altında ve sadece alçak sularda kullanın.

(GR) **(CY)** **Προειδοποίηση!** Να χρησιμοποιείται μόνο σε νερά όπου πατώνει το παιδί και υπό την επίβλεψη ενήλικου.

(RO) **AVERTISMENT!** A se utiliza numai acolo unde copilul poate sta în picioare în apă și este sub supraveghere.

(BG) **Внимание!** Да се използва само във вода, която е дълбока до нормалния ръст на детето, и под надзора на възрастен.

(HR) **Внимание!** Koristiti samo u plitkoj vodi pod nadzorom odraslih.

(RU) **Внимание!**

Использовать только на мелководье под наблюдением взрослых.

(CN) **警告!** 本玩具可在水上玩耍, 请在成人监护下使用, 避免发生溺水危险。

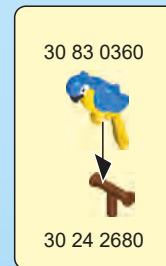
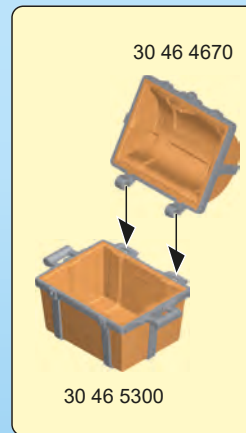
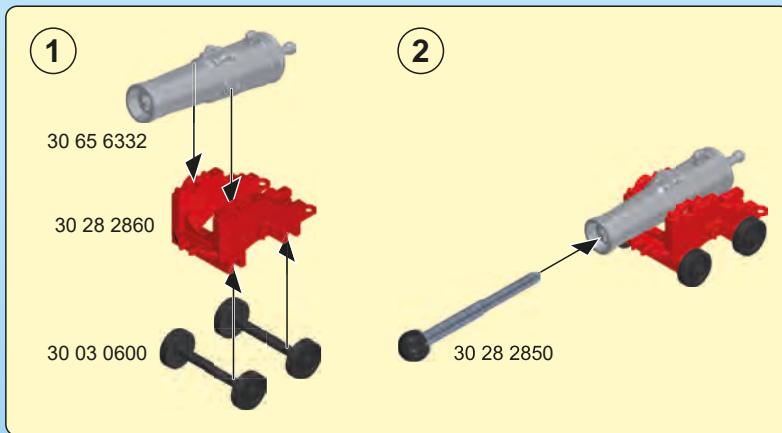

DE AT CH LU BE ACHTUNG! Nur mitgelieferte PLAYMOBIL Geschosse verwenden. Nicht auf Augen oder Gesicht zielen.

US GB CA MT IE WARNING! Only use the PLAYMOBIL projectiles supplied. Do not aim at eyes or face.

FR CA BE LU CH ATTENTION! Seulement utiliser les projectiles PLAYMOBIL fournis. Ne pas viser les yeux ou le visage

ES MX ¡ADVERTENCIA! Utiliza únicamente los proyectiles PLAYMOBIL suministrados. No apuntar a los ojos ni a la cara.

NL BE WAARSCHUWING! Uitsluitend meegeleverde PLAYMOBIL delen gebruiken. Niet op ogen of gezicht richten.

IT CH AVVERTENZA! Usare soltanto i proiettili PLAYMOBIL in dotazione. Non mirare agli occhi o al viso.

PT ATENÇÃO! Usar apenas os projécteis PLAYMOBIL juntamente fornecidos. Não apontar para os olhos ou face.

DK ADVARSEL! Anvend kun de medfølgende PLAYMOBIL projektiler. Sigt ikke mod øjne eller ansigt.

NO ADVARSEL! Benytt kun PLAYMOBIL prosjektil som leveres med. Sikt ikke på ansikt eller øyne.

SE FI WARNING! Använd endast medlevererade PLAYMOBIL-skott. Sikta inte mot ögon eller ansikte.

FI VAROITUS! Käytä vain mukana toimitettuja PLAYMOBIL-ammuksia. Ei saa kohdistaa suoraan silmiin tai kasvoihin.

HU FIGYELMEZTETÉS. Csak a csomagban található PLAYMOBIL lövedékeket szabad használni. Tilos szemre vagy arcra célozni.

CZ UPOZORNĚNÍ! Používejte pouze střely PLAYMOBIL, které jsou součástí dodávky. Nemířte na oči nebo na obličej!

EE HOIATUS! Kasutage ainult kaasaantud PLAYMOBIL'i laskemoona. Ära sihi silmadesse ega näkku.

LV BRIDINĀJUMS! Izmantoj tikai PLAYMOBIL piegādes komplektā iekļautos šāviņus. Nevērst pret acīm vai seju.

LT ĮSPĖJIMAS! Naudokite tik pridedamus PLAYMOBIL šaudmenis. Netaikyti į akis arba veidą.

SI OPOZORILO! Uporabljajte le priložene PLAYMOBIL-ove kroglice. Ne merite v oči ali obraz.

SK UPOZORNENIE! Používajte len náboje dodávané spolu so sadou PLAYMOBIL. Nemierť do očí alebo do tváre.

PL OSTRZEŻENIE! Stosować tylko załączone PLAYMOBIL -kule / pociski. Nie celować w oczy i twarz.

TR CY DİKKAT! Sadece birlikte verilen PLAYMOBIL mermileri kullanınız. Göze veya yüze doğru tutmayınız.

GR CY Προειδοποίηση! Να χρησιμοποιούνται αποκλειστικά τα βλήματα της PLAYMOBIL που περιέχονται στη συσκευασία. Μη μην γίνεται στόχευση στα μάτια ή στο πρόσωπο.

RO AVERTISMENT! Se folosesc doar proiectilele incluse PLAYMOBIL. Nu se țintește în ochi sau în față.

BG Внимание! Използвайте само приложени PLAYMOBIL снаряди. Не насочвайте към очите и лицето.

HR UPOZORENJE! Upotrijebiti samo od strane PLAYMOBIL-a isporučene projekte. Ne ciljati u oči ili lice.

RU Внимание! Используйте только поставляемые в комплекте снаряды PLAYMOBIL. Не цельтесь в глаза или в лицо.

CN 警告! 仅能用PLAYMOBIL 弹射物, 请勿瞄准眼睛或脸.

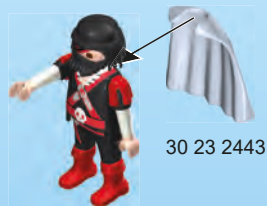

30 00 5762

30 23 1182



2x 30 22 2470



2x 30 27 4270

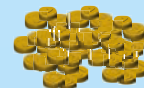

UK-Importer:
Playmobil UK Ltd.
Regency House
1 Miles Gray Road
Basildon
Essex
SS14 3RW
UK

UK
CA



Serviceadressen finden Sie in allen PLAYMOBIL-Prospekten

Addresses of Customer Service Departments are shown in all PLAYMOBIL catalogues

L'adresse du service consommateurs est indiquée dans tous les catalogues PLAYMOBIL

Troverete gli indirizzi dei centri di assistenza in tutti i cataloghi PLAYMOBIL

In alle PLAYMOBIL catalogi vindt u het adres van onze klantendienst.

Las Direcciones de los Departamentos de Servicio al Consumidor se encuentran en todos los catálogos PLAYMOBIL

Η διεύθυνση του Γραφείου Εξυπηρέτησης Καταναλωτών PLAYMOBIL βρίσκεται σε όλους τους καταλόγους PLAYMOBIL.

pronounced: plāy-mō-bēēl



© 2014 geobra Brandstätter Stiftung & Co.KG

Brandstätterstr. 2-10
90513 Zimndorf, Germany.
No. 30 81 9135 12.22