

playmobil®

5919

Wichtige Unterlagen, bitte sorgfältig aufbewahren!
Important: Please keep these instructions for future reference!
Documents importants, à conserver soigneusement!
Belangrijke documenten, bewaar deze zorgvuldig!

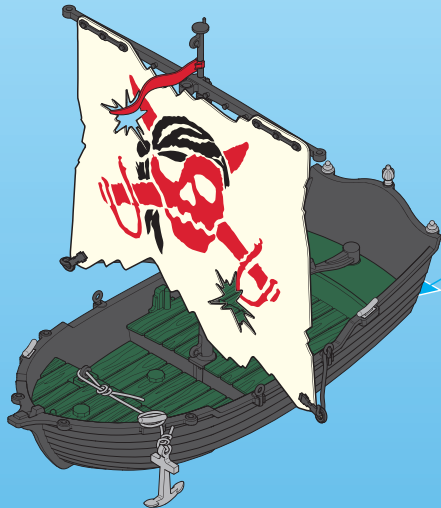

5159
7350

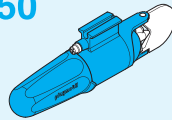

- Nachrüstbar mit Unterwassermotor
- Compatible with the underwater motor (sold separately)
- Monteur submersible, vendu séparément, s'adapte sur ce bateau



WARNING: CHOKING HAZARD

Contains a small ball and small parts.
Not for children under 3 years.

”Ne concerne que les USA“



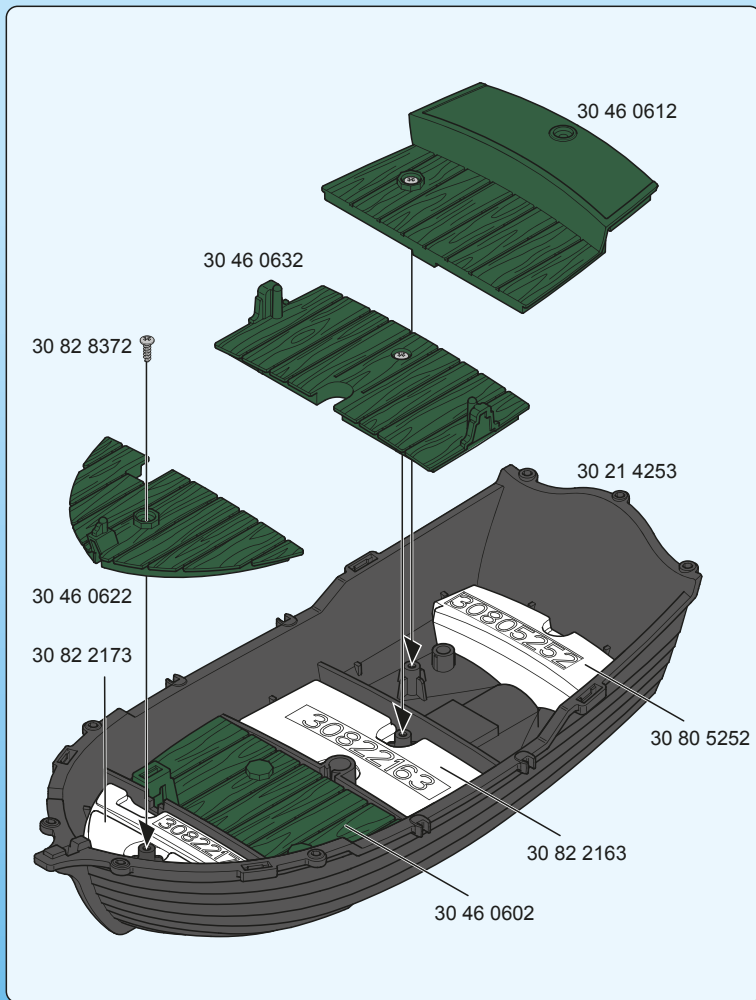

1

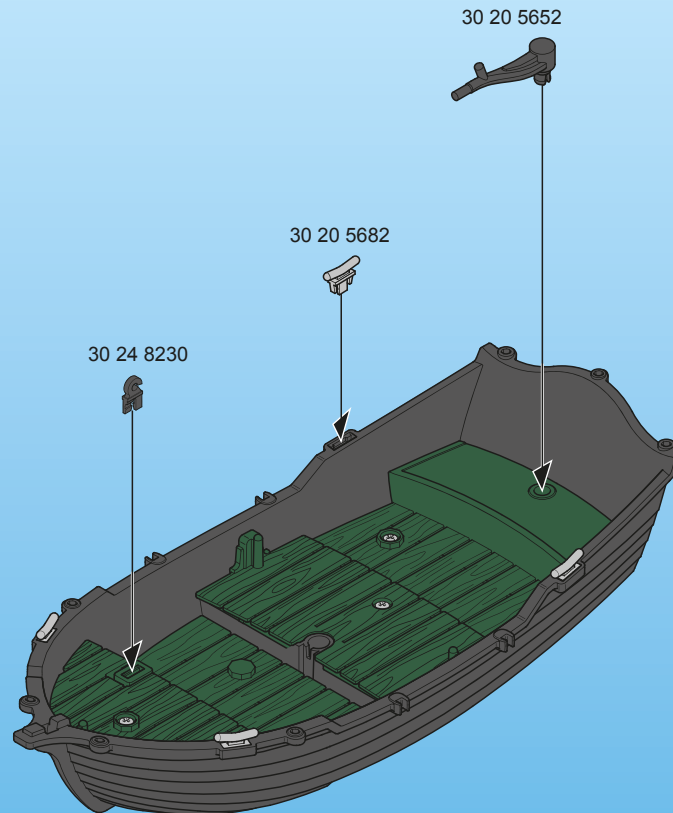

2

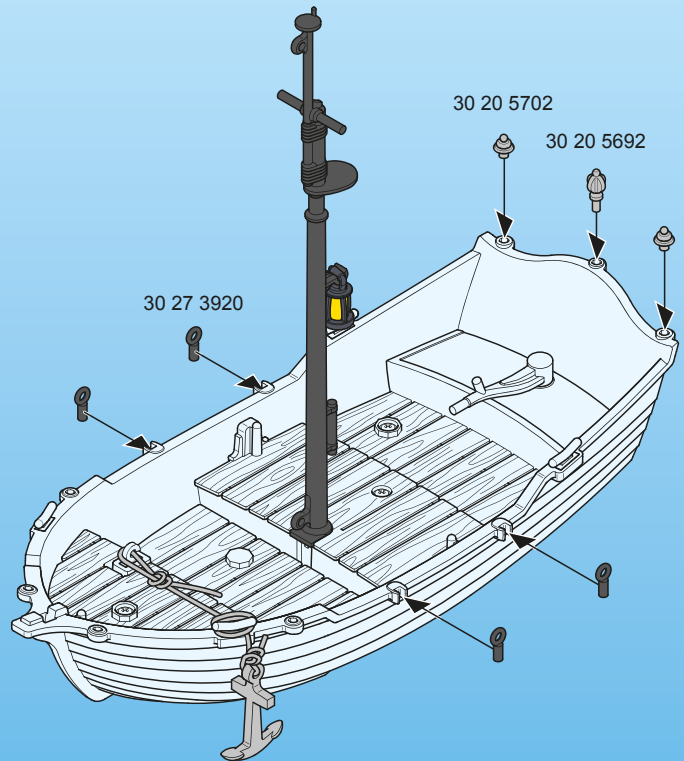
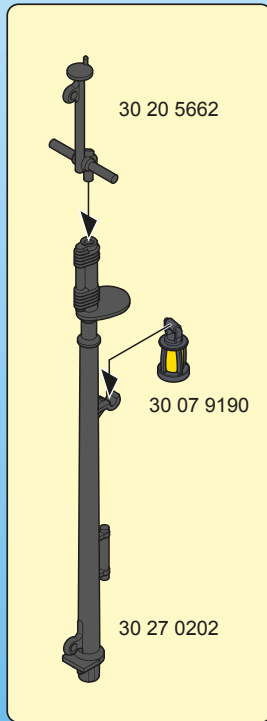
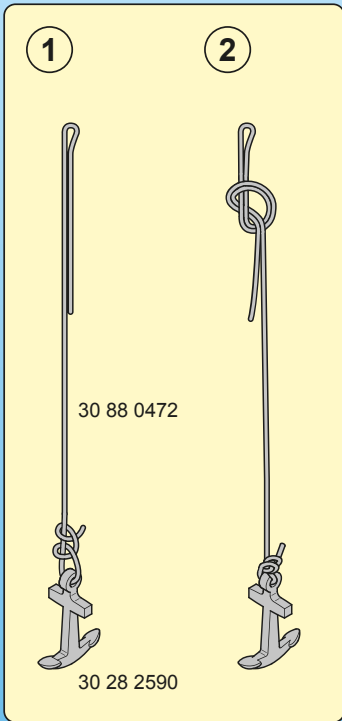

1

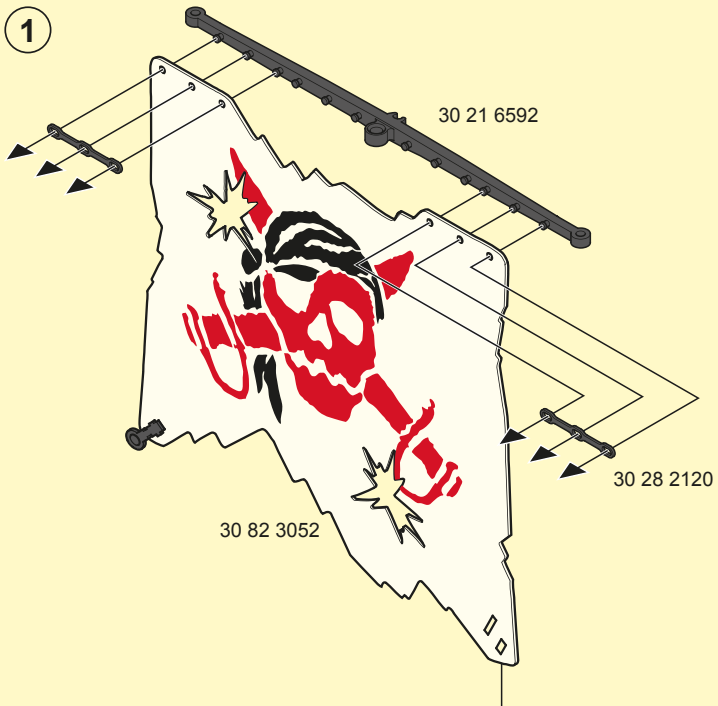

2



1

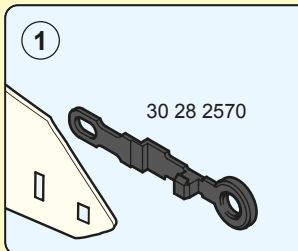

2

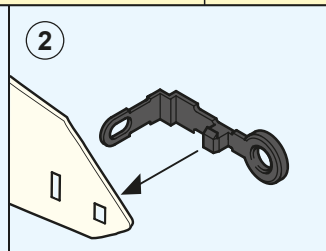

3

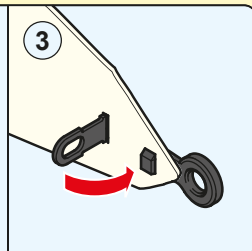

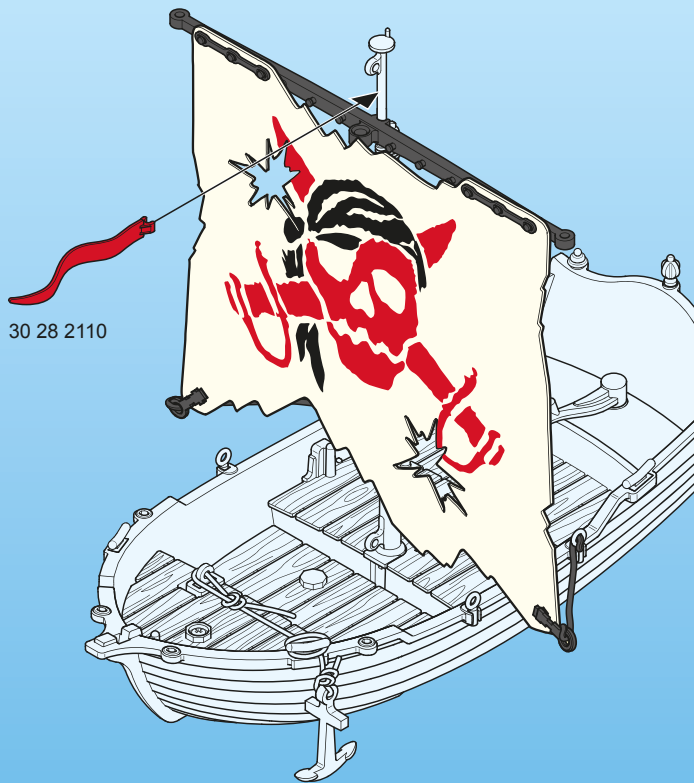

30 28 2110

- D** **A** **CH** **L** **B** Anbaumöglichkeiten des RC-UW-Motors finden Sie unter: RC-Motor.playmobil.com
- USA** **GB** **CDN** **M** **IRL** For RC UW motor attachment possibilities, visit: RC-Motor.playmobil.com
- F** **CDN** **B** **L** **CH** Vous trouverez des informations complémentaires sur le site Internet: RC-Motor.playmobil.com
- E** **MEX** Las posibilidades de montaje del motor submarino RC se pueden consultar en: RC-Motor.playmobil.com
- NL** **B** Aanbouw mogelijkheden van de RC-Onderwatermotor vindt u op: RC-Motor.playmobil.com
- I** **CH** Le possibilità di montaggio del motore RC-UW sono descritte al sito: RC-Motor.playmobil.com
- P** As possibilidades de montagem do motor RC subaquático pode ser consultadas em: RC-Motor.playmobil.com
- DK** Montagemuligheder for RC-UW-motoren finder du på: RC-Motor.playmobil.com
- N** Monteringsmuligheter for RC-UW-motoren finner du under: RC-Motor.playmobil.com
- S** **FIN** RC-undervattensmotorers monteringsmöjligheter hittar du på: RC-Motor.playmobil.com
- FIN** Vedenalaisen RC-moottorin asennusmahdollisuksia löytyy osoitteesta: RC-Motor.playmobil.com
- H** Az RC-UW- Motor hozzáépítési lehetőségeiről az RC-Motor.playmobil.com alatt talál anyagot.
- CZ** Možnosti instalace lodního motoru s dálkovým ovládním najdete na internetové adrese RC-Motor.playmobil.com
- EST** RC-UW-Motor'i paigaldusjuhised leiate aadressil: RC-Motor.playmobil.com
- LV** Informāciju par RC-UUV motora montāžas iespējām skati vietnē: RC-Motor.playmobil.com
- LT** RC UW variklio pritvirtinimo galimybės pateikiamos tokiaame internetiniame puslapyje: RC-Motor.playmobil.com
- SLO** Možni načini namestitve daljinsko krmiljenega (RC) podvodnega (UW) motorja so na voljo na naslovu: RC-Motor.playmobil.com
- SK** Možnosti inštalácie lodného motoru s diaľkovým ovládním nájdete na internetovej adrese RC-Motor.playmobil.com
- PL** Możliwości zastosowania podwodnego silnika RC znajdują się na stronie: RC-Motor.playmobil.com
- TR** **CY** Uzaktan kumandali su altı motorunun montaj kılavuzu RC-Motor.playmobil.com sayfasında gösterilmiştir
- GR** **CY** Οδηγίες συναρμολόγησης του τηλεκατευθυνόμενου μοτέρ με υπέρυθρες ακτίνες θα βρείτε στην ηλεκτρονική διεύθυνση: RC-Motor.playmobil.com
- RO** Posibilități de montare a motorului submersibil cu telecomandă se găsesc pe site-ul: RC-Motor.playmobil.com
- BG** Възможности за допълнително оборудване на RC-електромотора за под вода можете да намерите на адрес: RC-Motor.playmobil.com
- CN** 了解红外线水下电机的安装方法请访问以下网站: RC-Motor.playmobil.com

1

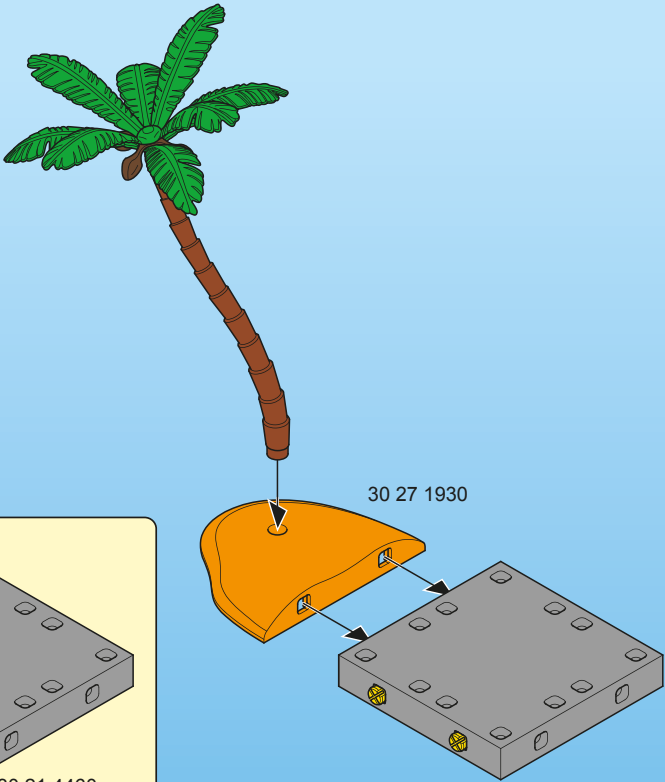
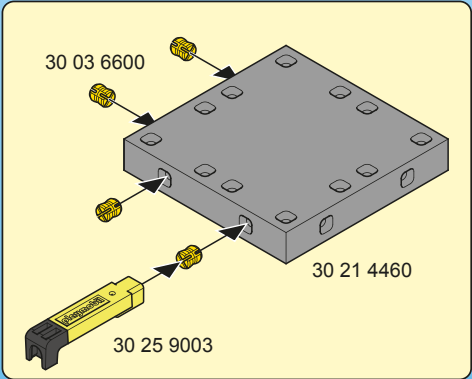
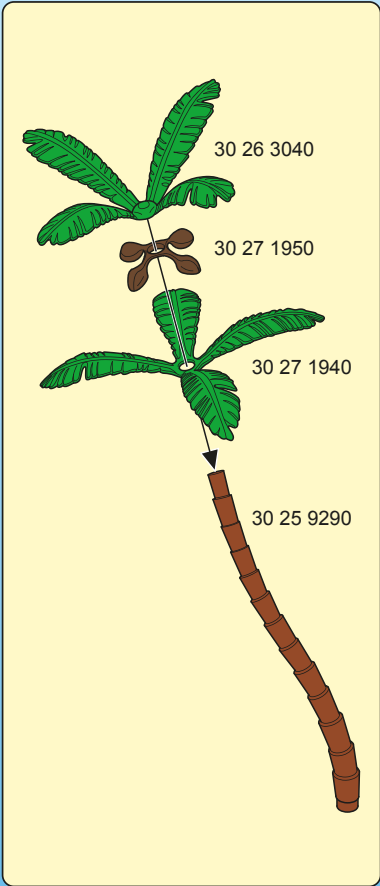

2

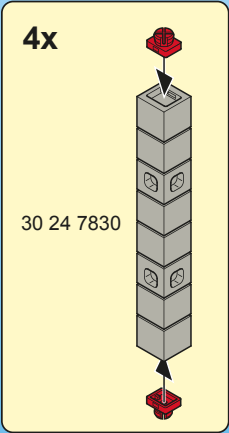
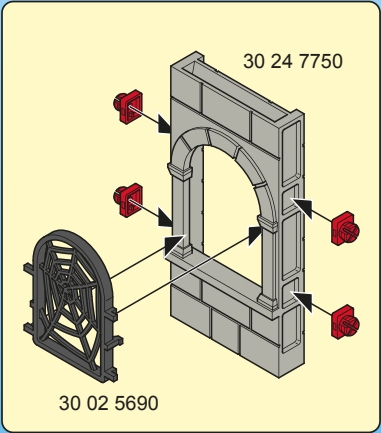
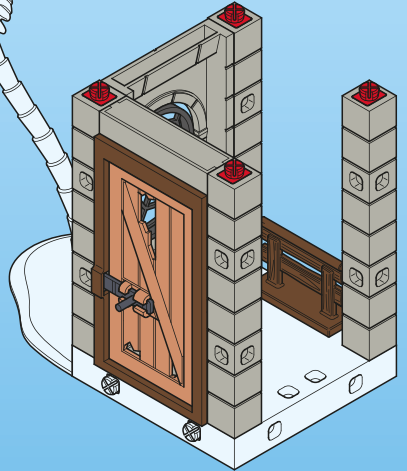
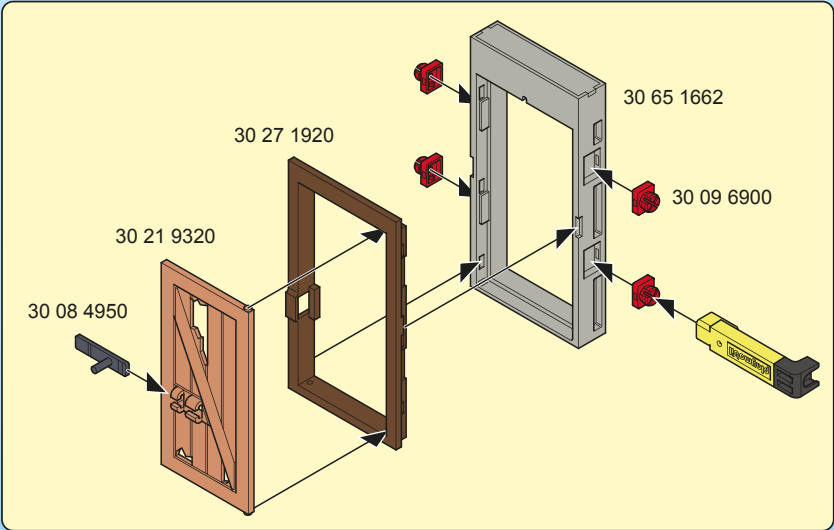

3

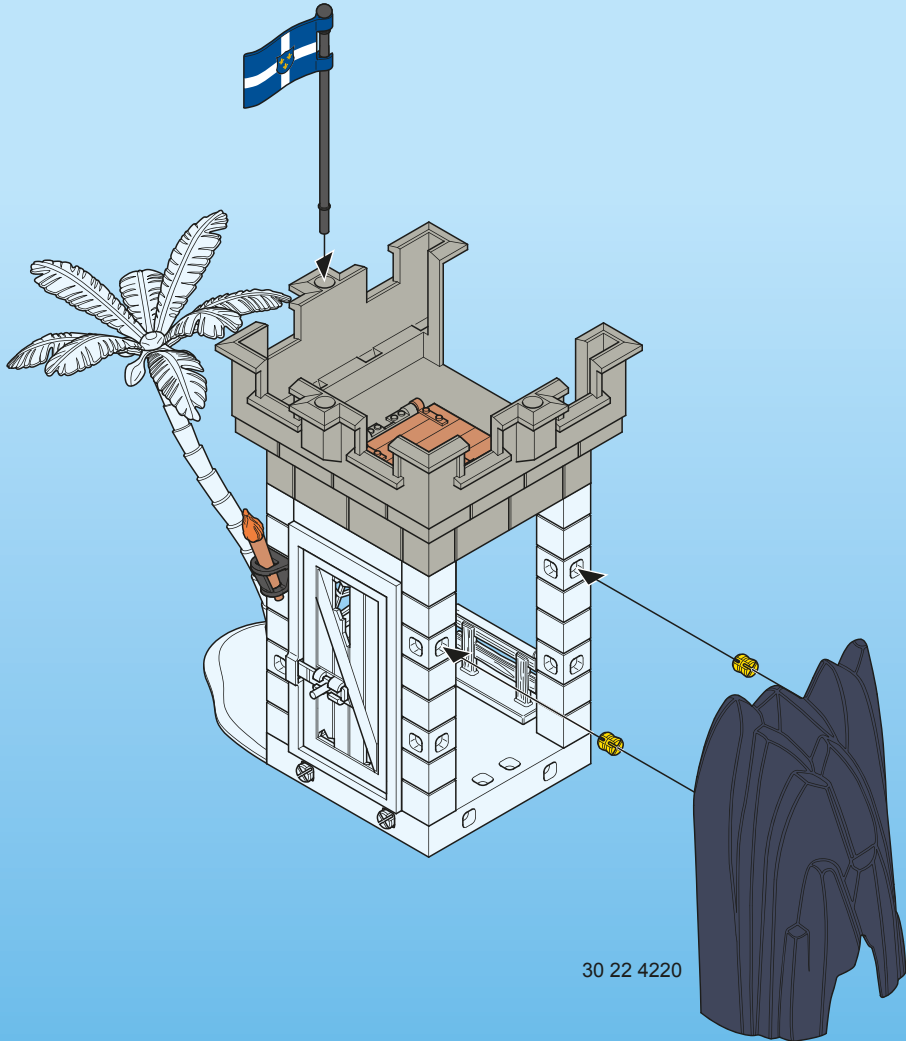
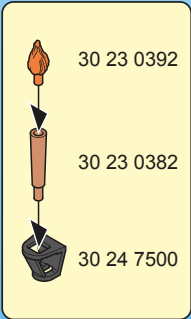
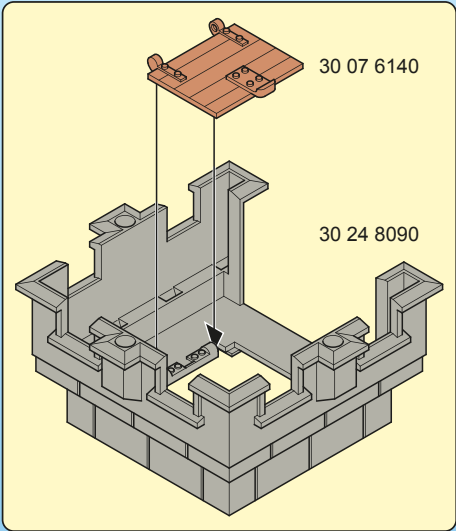

4

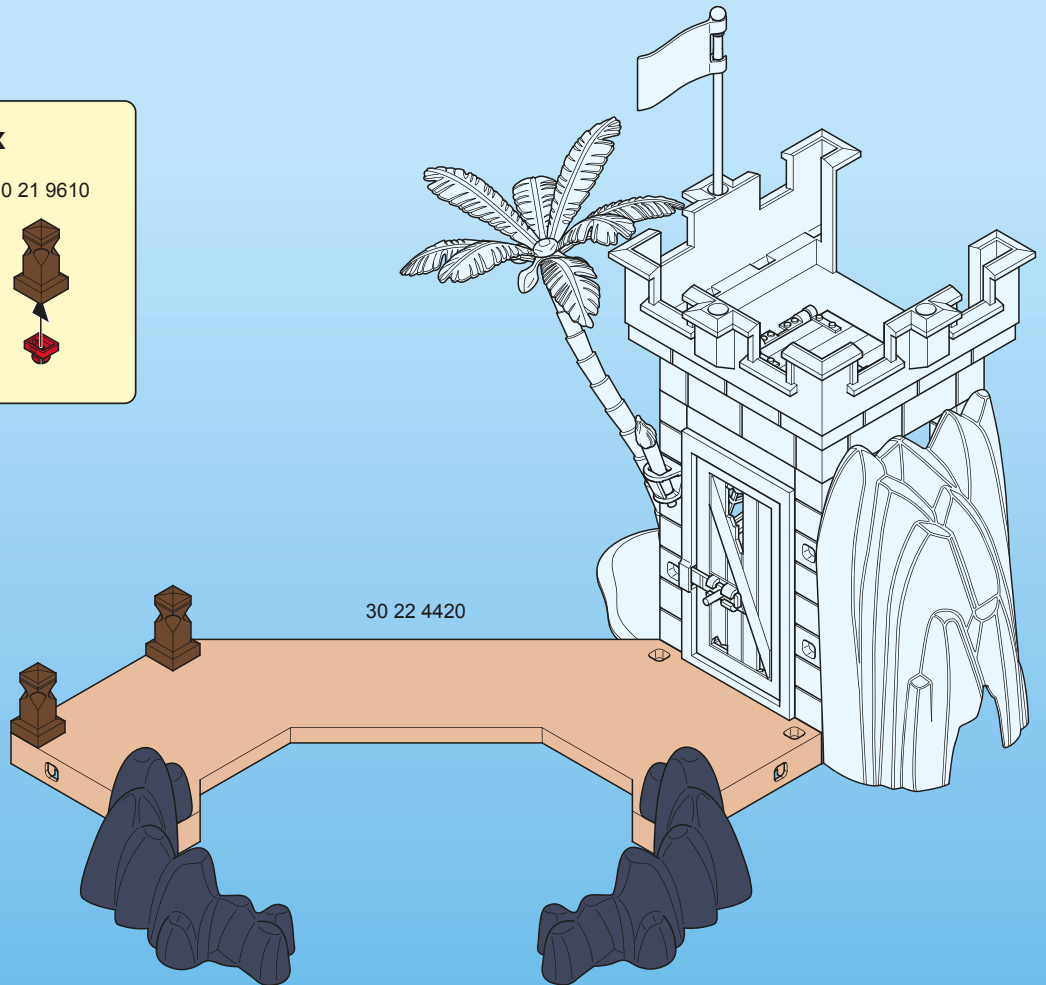
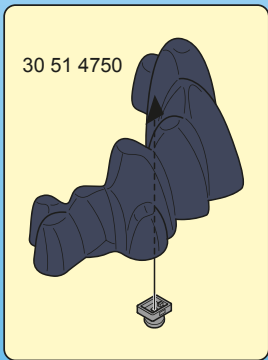
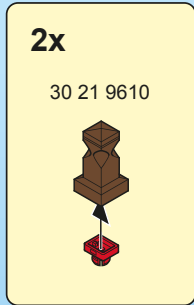
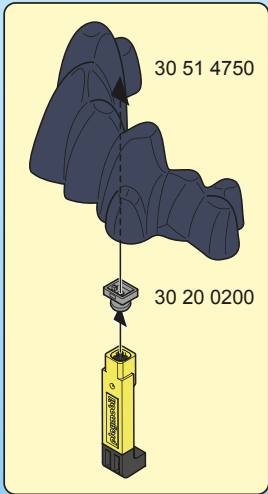

(D) (A) (CH) (L) (B) ACHTUNG!

- Nur im flachen Wasser unter Aufsicht von Erwachsenen verwenden.
- Nur mitgelieferte PLAYMOBIL Geschosse verwenden. Nicht auf Augen oder Gesicht zielen.

(USA) (GB) (CDN) (M) (IRL) WARNING!

- Only to be used in water in which the child is within its depth and under adult supervision.
- Only use the PLAYMOBIL projectiles supplied. Do not aim at eyes or face.

(F) (CDN) (B) (L) (CH) ATTENTION!

- À n'utiliser qu'en eau où l'enfant a pied et sous la surveillance d'un adulte.
- Seulement utiliser les projectiles PLAYMOBIL fournis. Ne pas viser les yeux ou le visage

(E) (MEX) ATENCIÓN.

- Utilizar sólo en agua donde el niño pueda permanecer de pie y bajo vigilancia de un adulto.
- Usar únicamente los proyectiles PLAYMOBIL suministrados. No apuntar a los ojos ni a la cara.

(NL) (B) LET OP.

- Gebruiken in water waar kinderen kunnen staan en onder toezicht van volwassenen.
- Uitsluitend meegeleverde PLAYMOBIL delen gebruiken. Niet op ogen of gezicht richten.

(I) (CH) ATTENZIONE!

- Da utilizzare unicamente in acqua dove il bambino tocca il fondo con i piedi e sotto la sorveglianza di un adulto.
- Usare soltanto i proiettili PLAYMOBIL in dotazione. Non mirare agli occhi o al viso.

(P) AVISO!

- Só utilizar em água onde a criança tenha pé e sob vigilância de adultos.
- Usar apenas os projécteis PLAYMOBIL juntamente fornecidos. Não apontar para os olhos ou face.

(DK) ADVARSEL!

- Må kun anvendes under opsyn af en voksen og på vanddybder, hvor barnet kan bunde.
- Anvend kun de medfølgende PLAYMOBIL projektiler. Sigt ikke mod øjne eller ansigt.

(N) ADVARSEL!

- Skal kun brukes i vann som ikke er for dypt for barnet, og der barnet er under tilsyn.
- Benytt kun PLAYMOBIL prosjektil som leveres med. Sikt ikke på ansikt eller øyne.

(S) (FIN) OBSERVERA.

- Får endast användas i vatten där barnet bottnar och under tillsyn av en vuxen.
- Använd endast medlevererade PLAYMOBIL-skott. Sikta inte mot ögon eller ansikte.

(FIN) HUOMIO.

- Lelua saa käyttää vain aikuisen valvonnassa vedessä, jossa lapsi yletty pohjaan.
- Käytä vain mukana toimitettuja PLAYMOBIL-ammuksia. Ei saa kohdistaa suoraan silmiin tai kasvoihin.

(H) FIGYELMEZTETÉS.

- Csak a gyermek magasságához képest biztonságos sekély vízben és felnőtt felügyelete mellett szabad használni!
- Csak a csomagban található PLAYMOBIL lövedékeket szabad használni. Tilos szemre vagy arcra célozni.

(CZ) VAROVÁNÍ!

- Používat pouze ve vodě takové hloubky, kde dítě stačí, a pouze pod dohledem dospělé osoby.
- Používejte pouze střely PLAYMOBIL, které jsou součástí dodávky. Nemiřte na oči nebo na obličej!

(EST) HOIATUS!

- Kasutada ainult täiskasvanu järelevalve all vees, kus laps ulatub jalgadega põhja.
- Kasutage ainult kaasaantud PLAYMOBIL'i laskemoona. Ära sihi silmadesse ega näkku.

(LV) BRĪDINĀJUMS!

- Lietot tikai sekļā ūdenī un pieaugušo uzraudzībā.
- Izmantot tikai PLAYMOBIL piegādes komplektā iekļautos šāviņus. Nevērst pret acīm vai seju.

(LT) DĖMESIO!

- Naudoti tik vaikai tinkamame gylje ir prižiūrint suaugusiesiems.
- Naudokite tik pridedamus PLAYMOBIL šaudmenis. Netaikyti į akis arba veidą.

(SLO) OPOZORILO!

- Uporabljajte samo v vodi, primerno plitvi za otroka in pod nadzorom odrasle osebe.
- Uporabljajte le priložene PLAYMOBIL-ove krogle. Ne merite v oči ali obraz.

(SK) UPOZORNENIE!

- Používať len vo vode, v ktorej dieťa dočiahne na dno, a pod dohľadom dospelých osôb.
- Používajte len náboje dodávané spolu so sadou PLAYMOBIL. Nemierniť do očí alebo do tváre.

(PL) UWAGA!

- Do używania jedynie w wodzie na głębokości, na której dziecko wyczuwa dno pod nogami oraz pod nadzorem osoby dorosłej.
- Stosować tylko załączone PLAYMOBIL - kule / pociski. Nie celować w oczy i twarz.

(TR) (CY) DİKKAT!

- Sadece denetim altında ve sadece alçak sularda kullanın.
- Sadece birlikte verilen PLAYMOBIL mermileri kullanınız. Göze veya yüze doğru tutmayınız.

(GR) (CY) ΠΡΟΣΟΧΗ.

- Να χρησιμοποιείται μόνο σε νερά όπου πατώνει το παιδί και υπό την επίβλεψη ενήλικου.
- Να χρησιμοποιούνται αποκλειστικά τα βλήματα της PLAYMOBIL που περιέχονται στη συσκευασία. Μη μην γίνεται στόχευση στα μάτια ή στο πρόσωπο.

(RO) AVERTIZARE!

- A se utiliza numai acolo unde copilul poate sta în picioare în apă și este sub supraveghere.
- Se folosec doar proiectilele incluse PLAYMOBIL. Nu se țintește în ochi sau în față.

(BG) ПРЕДУПРЕЖДЕНИЕ!

- Да се използва само във вода, която е дълбока до нормалния ръст на детето, и под надзора на възрастен.
- Използвайте само приложени PLAYMOBIL снаряди. Не насочвайте към очите и лицето.

(CN) 警告!

- 可供孩子在水中使用，但必须在有人监护的情况下。
- 仅能用PLAYMOBIL的炮弹。禁止瞄准眼睛或脸。请勿瞄准眼睛或脸。

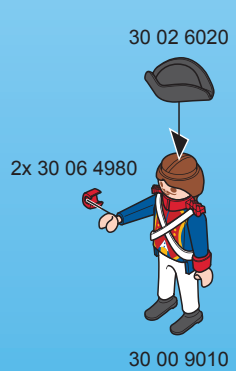
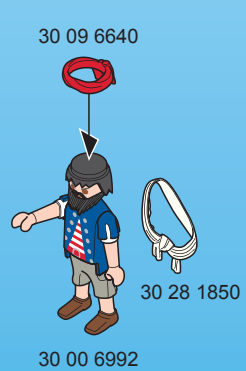
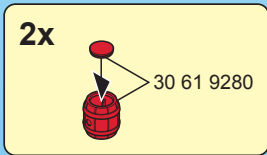
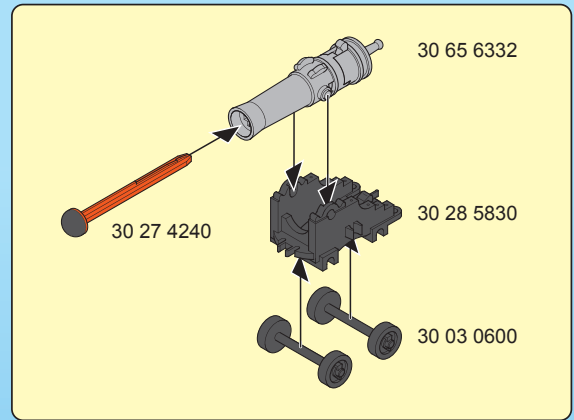
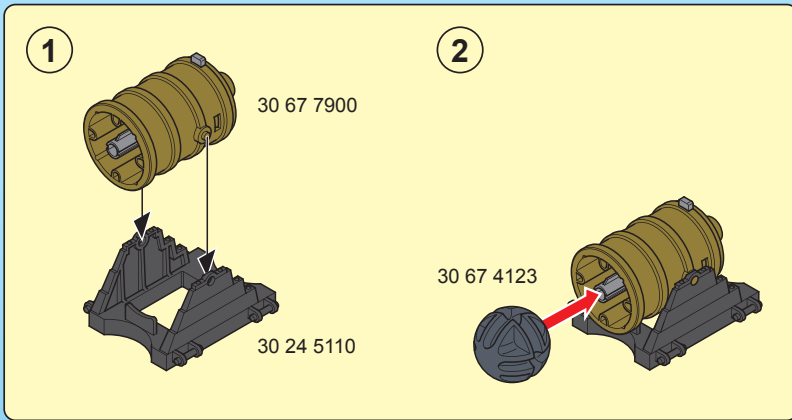

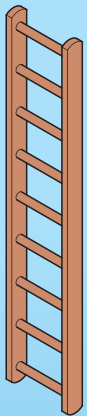

30 02 8750



30 83 0360



30 66 7460



30 06 6070



2x 30 06 3690



30 06 0710



30 24 3959



30 09 5440

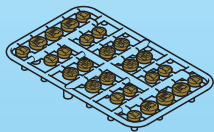

30 61 3730



30 08 3430



30 62 6240



30 21 3363



30 21 3373

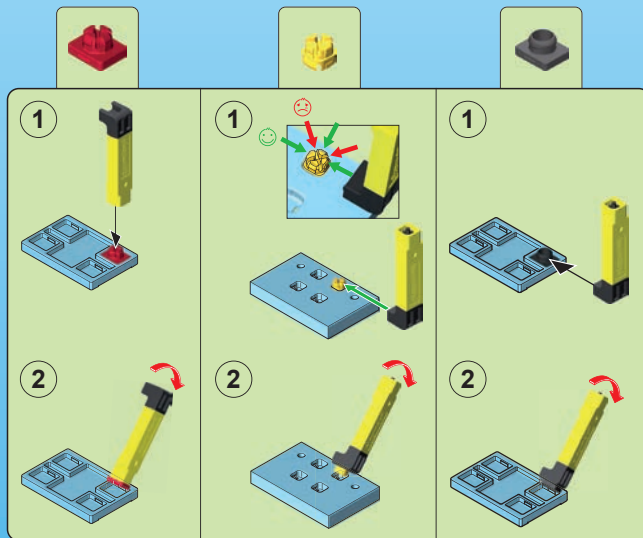

Serviceadressen finden Sie in allen Playmobil-Prospekten

Addresses of Customer Service Departments are shown in all Playmobil catalogues

L'adresse du service consommateurs est indiquée dans tous les catalogues Playmobil

Troverete gli indirizzi dei centri di assistenza in tutti i cataloghi Playmobil

In alle PLAYMOBIL catalogi vindt u het adres van onze klantendienst.

Las Direcciones de los Departamentos de Servicio al Consumidor se encuentran en todos los catálogos Playmobil

Η διεύθυνση του Γραφείου Εξυπηρέτησης Καταναλωτών PLAYMOBIL βρίσκεται σε όλους τους καταλόγους PLAYMOBIL.

pronounce: plāy-mō-bēēl

© 2010 geobra Brandstätter Stiftung & Co.KG
 Brandstätterstr. 2-10
 90513 Zirndorf, Germany.
 No. 30 82 2843 04.19



www.playmobil.com