

playmobil®

5390



WARNING: CHOKING HAZARD

Small parts. Not for children under 3 years.

"Ne concerne que les USA"

Wichtige Unterlagen, bitte sorgfältig aufbewahren!
Important: Please keep these instructions for future reference!
Documents importants, à conserver soigneusement!
Belangrijke documenten, bewaar deze zorgvuldig!



5159
7350



- Nachrüstbar mit Unterwassermotor
- Compatible with the underwater motor (sold separately)
- Monteur submersible, vendu séparément, s'adapte sur ce bateau

Serviceadressen finden Sie in allen Playmobil-Prospekten

Addresses of Customer Service Departments are shown in all Playmobil catalogues

L'adresse du service consommateurs est indiquée dans tous les catalogues Playmobil

Troverete gli indirizzi dei centri di assistenza in tutti i cataloghi Playmobil

In alle PLAYMOBIL catalogi vindt u het adres van onze klantendienst.

Las Direcciones de los Departamentos de Servicio al Consumidor se encuentran en todos los catálogos Playmobil

Η διεύθυνση του Γραφείου Εξυπηρέτησης Καταναλωτών PLAYMOBIL βρίσκεται σε όλους τους καταλόγους PLAYMOBIL.

pronounce: plāy-mō-bēēl

1

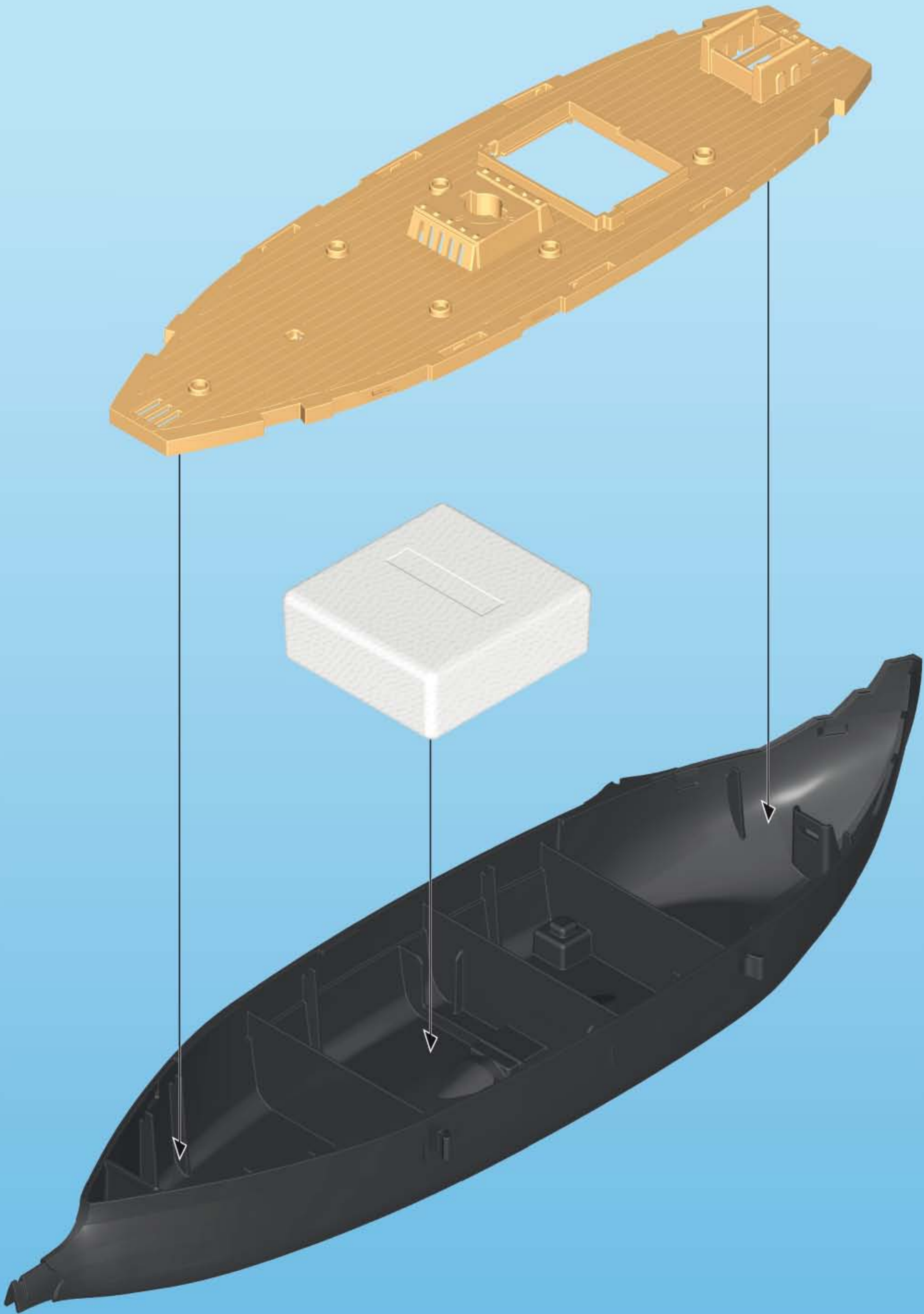

2

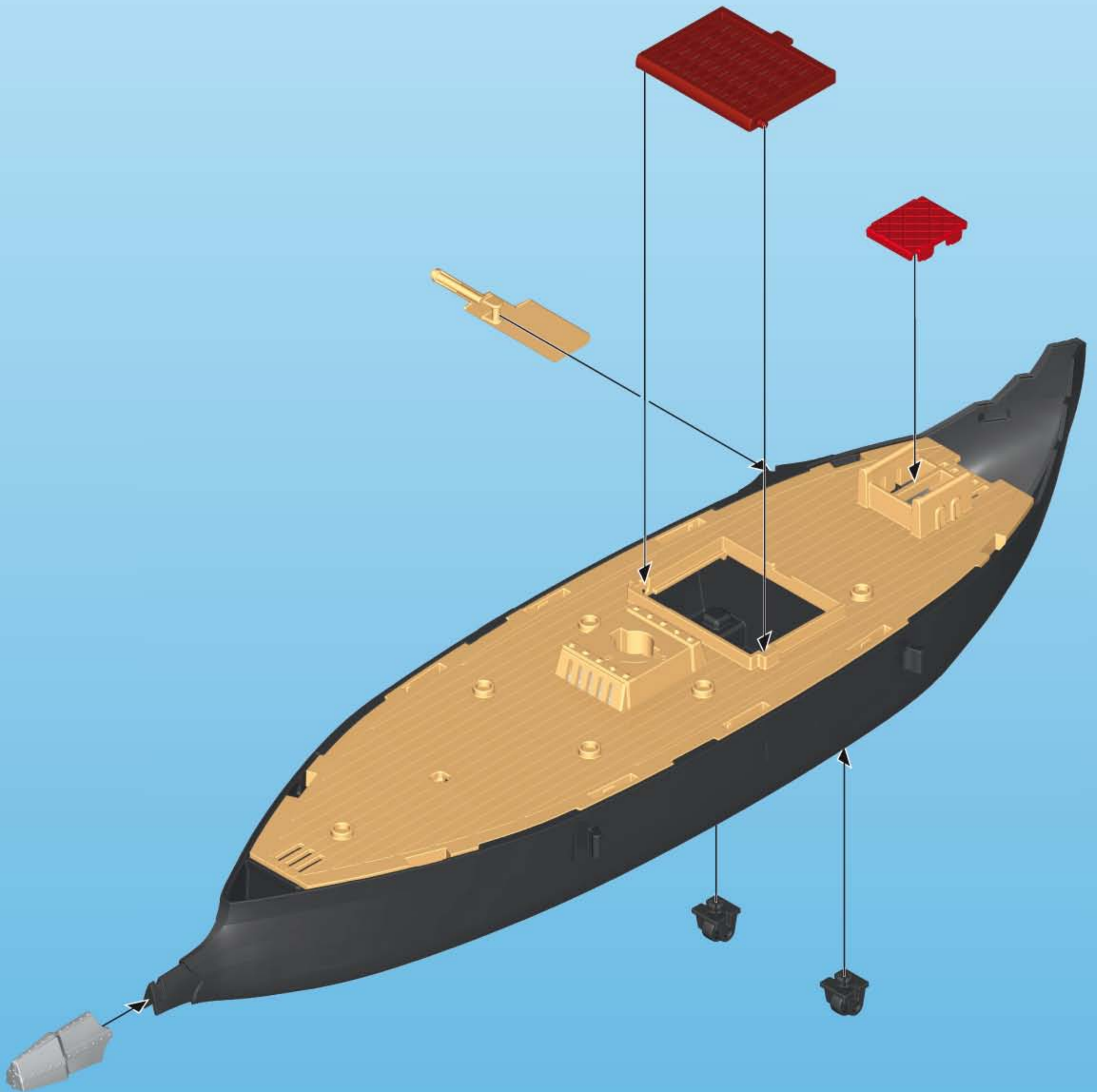
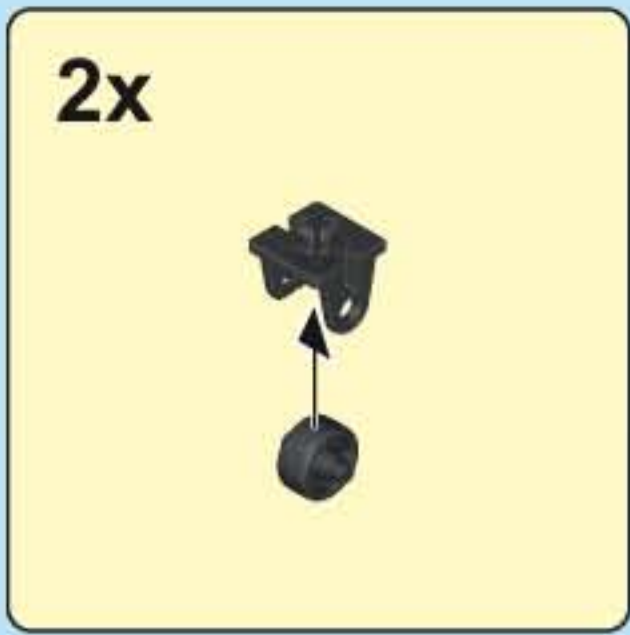

3

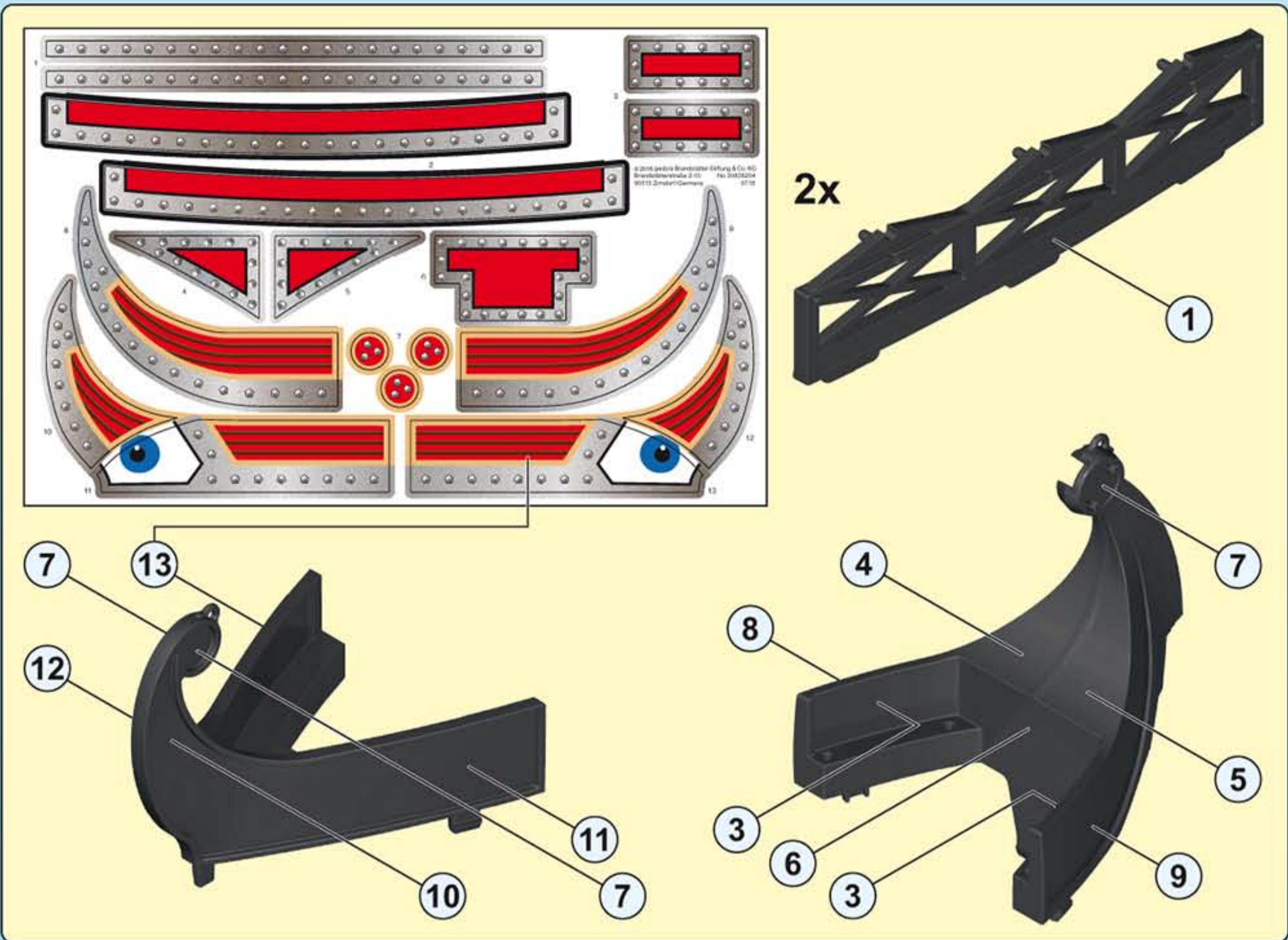

4

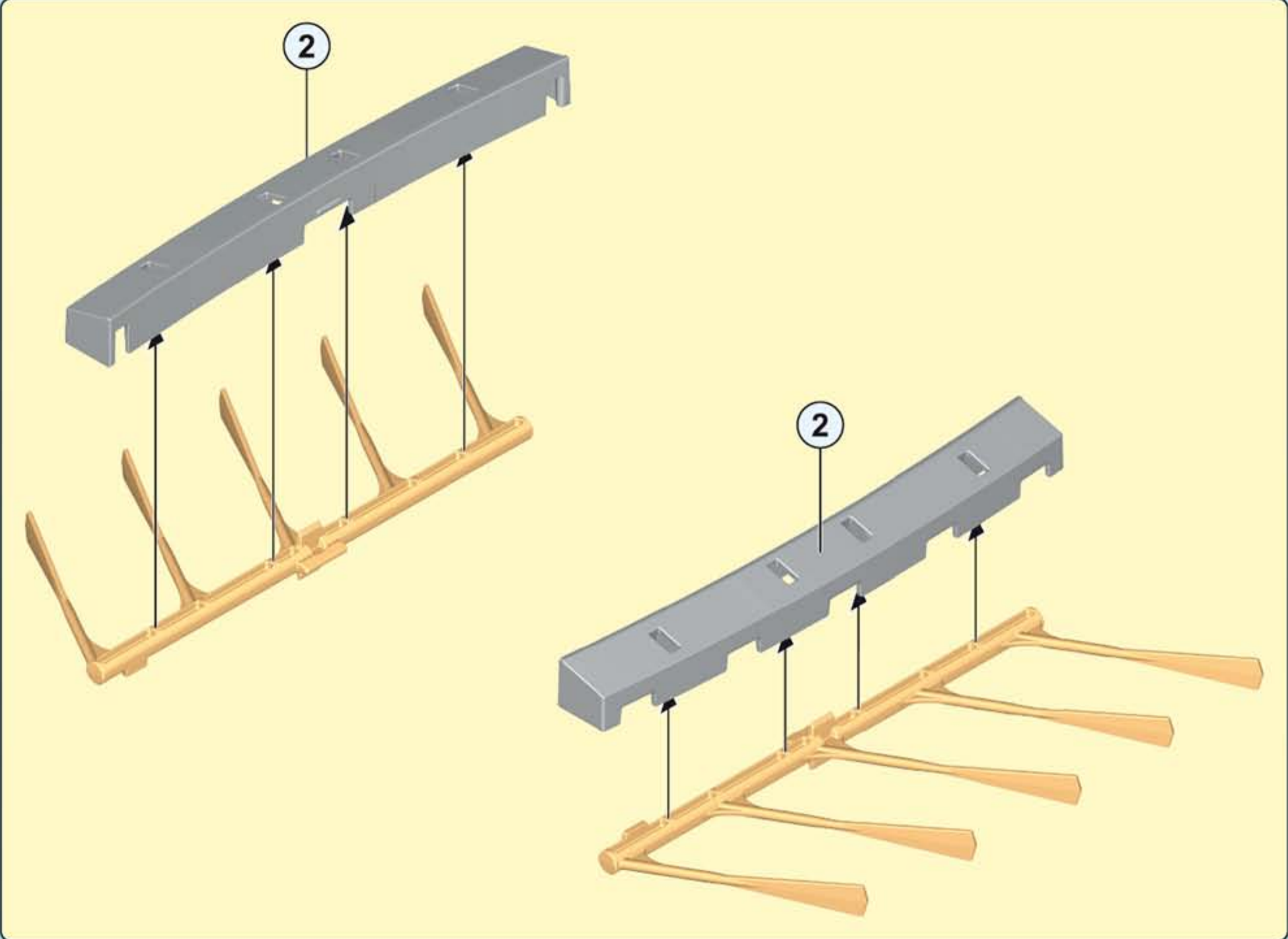

5

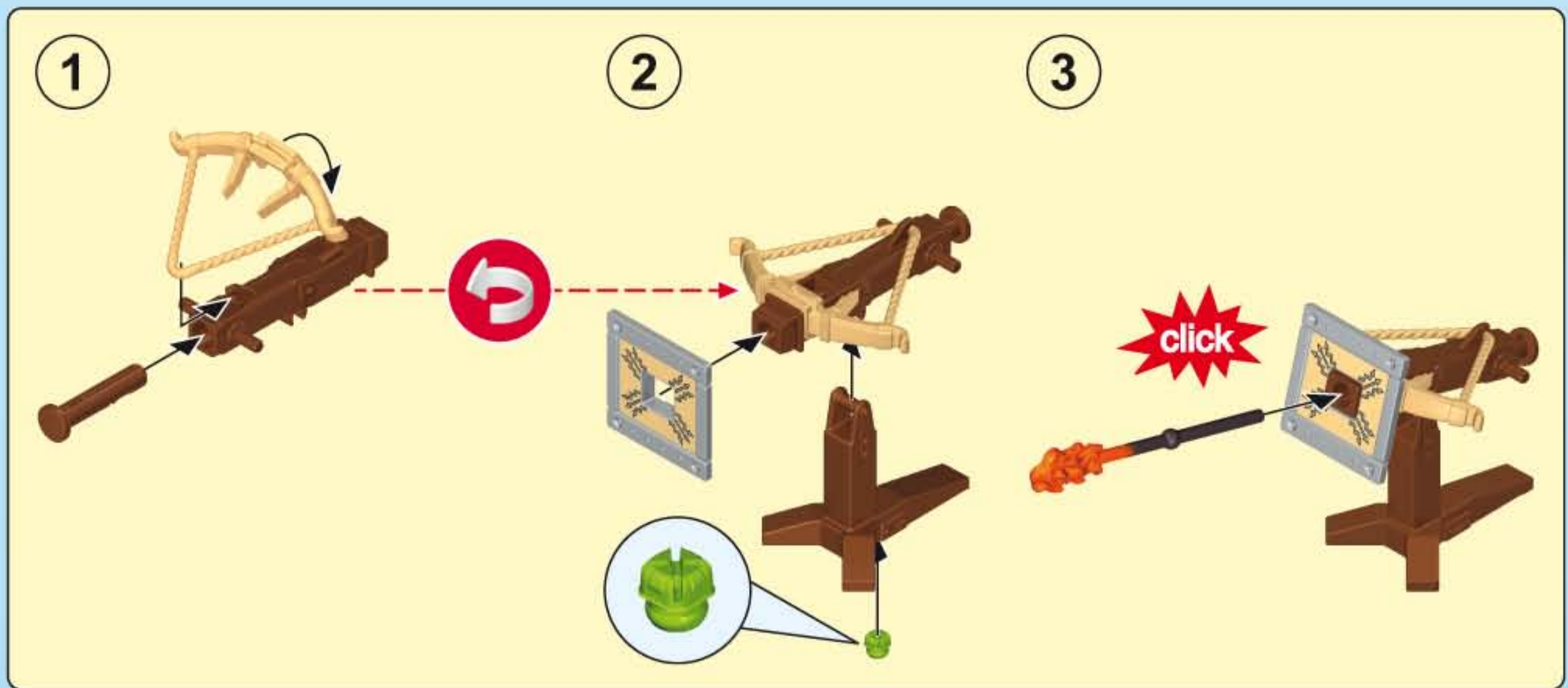

6



7

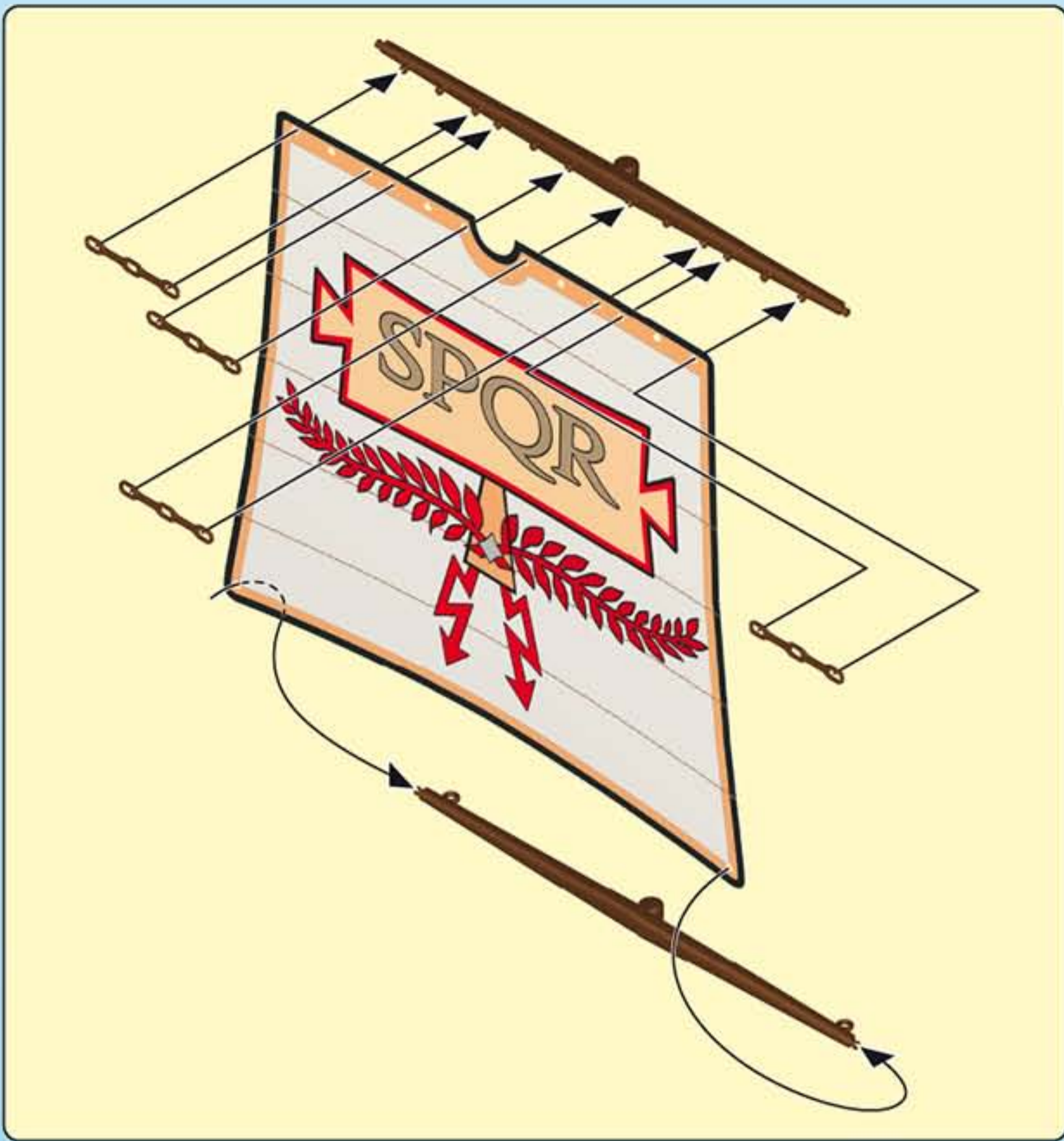



- D A CH L B** Anbaumöglichkeiten des RC-UW-Motors finden Sie unter: RC-Motor.playmobil.com
- USA GB CDN M IRL** For RC UW motor attachment possibilities, visit: RC-Motor.playmobil.com
- F CDN B L CH** Vous trouverez des informations complémentaires sur le site Internet: RC-Motor.playmobil.com
- E MEX** Las posibilidades de montaje del motor submarino RC se pueden consultar en: RC-Motor.playmobil.com
- NL B** Aanbouwmogelijkheden van de RC-Onderwatermotor vindt u op: RC-Motor.playmobil.com
- I CH** Le possibilità di montaggio del motore RC-UW sono descritte al sito: RC-Motor.playmobil.com
- P** As possibilidades de montagem do motor RC subaquático pode ser consultadas em: RC-Motor.playmobil.com
- DK** Montagemuligheder for RC-UW-motoren finder du på: RC-Motor.playmobil.com
- N** Monteringsmuligheter for RC-UW-motoren finner du under: RC-Motor.playmobil.com
- S FIN** RC-undervattensmotorns monteringsmöjligheter hittar du på: RC-Motor.playmobil.com
- FIN** Vedenalaisen RC-moottorin asennusmahdollisuuksia löytyy osoitteesta: RC-Motor.playmobil.com
- H** Az RC-UW- Motor hozzáépítési lehetőségeiről az RC-Motor.playmobil.com alatt talál anyagot.
- CZ** Možnosti instalace lodního motoru s dálkovým ovládním najdete na internetové adrese RC-Motor.playmobil.com
- EST** RC-UW-Motor'i paigaldusjuhised leiate aadressil: RC-Motor.playmobil.com
- LV** Informāciju par RC-UWV motora montāžas iespējām skati vietnē: RC-Motor.playmobil.com
- LT** RC UW variklio pritvirtinimo galimybes pateikiamos tokiame internetiniame puslapyje: RC-Motor.playmobil.com
- SLO** Možni načini namestitve daljinsko krmiljenega (RC) podvodnega (UW) motorja so na voljo na naslovu: RC-Motor.playmobil.com
- SK** Možnosti inštalácie lodného motora s diaľkovým ovládním nájdete na internetovej adrese RC-Motor.playmobil.com
- PL** Możliwości zastosowania podwodnego silnika RC znajdują się na stronie: RC-Motor.playmobil.com
- TR CY** Uzaktan kumandalı su altı motorunun montaj kılavuzu RC-Motor.playmobil.com sayfasında gösterilmiştir
- GR CY** Οδηγίες συναρμολόγησης του τηλεκατευθυνόμενου μοτέρ με υπέρυθρες ακτίνες θα βρείτε στην ηλεκτρονική διεύθυνση: RC-Motor.playmobil.com
- RO** Posibilități de montare a motorului submersibil cu telecomandă se găsesc pe site-ul: RC-Motor.playmobil.com
- BG** Възможности за допълнително оборудване на RC-електромотора за под вода можете да намерите на адрес: RC-Motor.playmobil.com
- HR** Mogućnosti dogradnje RC-UW-Motora ćete pronaći pod: RC-Motor.playmobil.com
- CN** 了解红外线水下电机的安装方法请访问以下网站: RC-Motor.playmobil.com

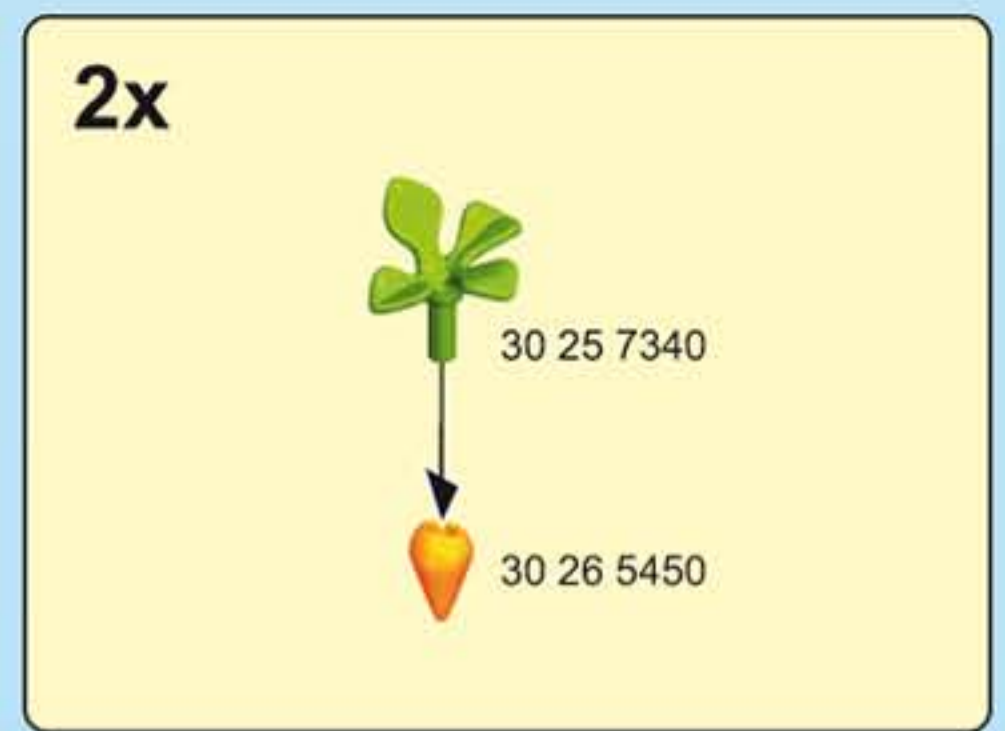
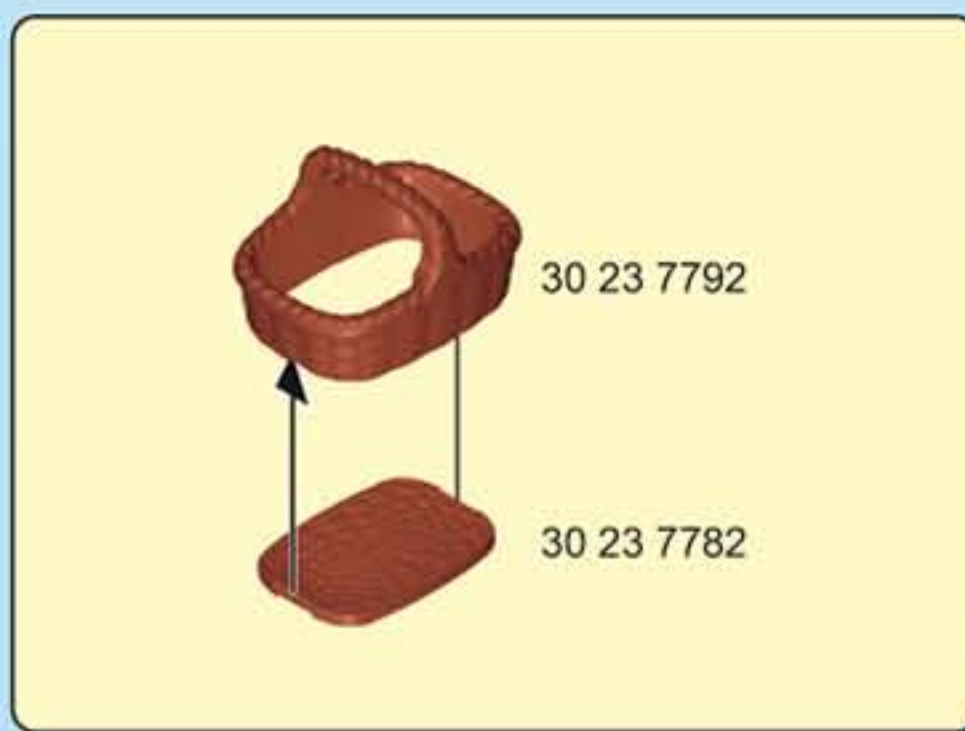
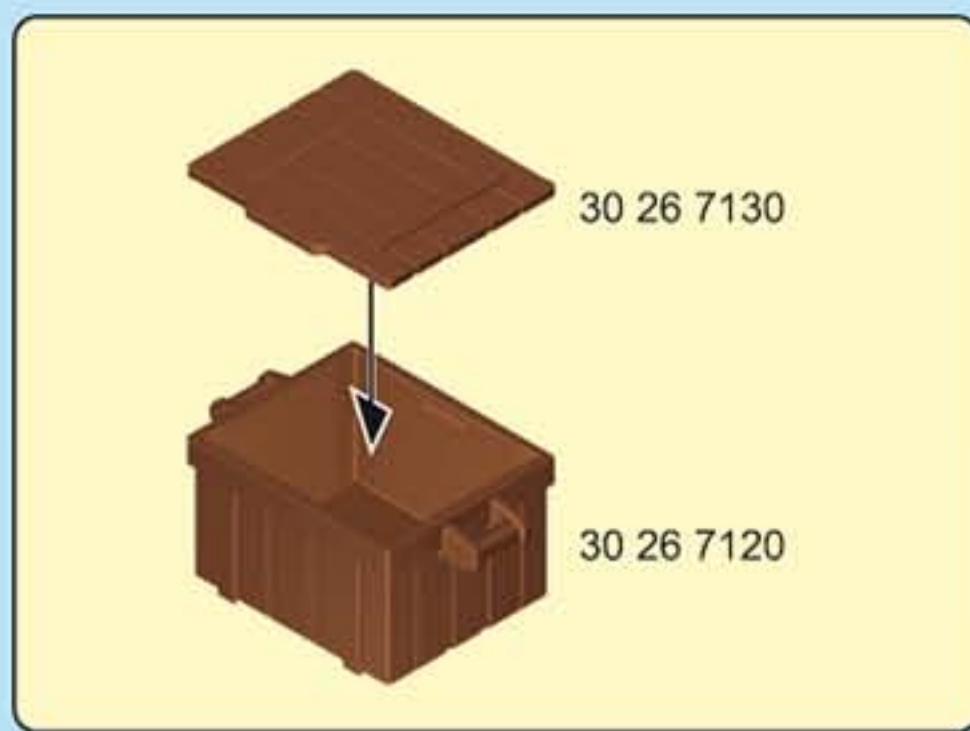

(D) (A) (CH) (L) (B) ACHTUNG!

- Nur im flachen Wasser unter Aufsicht von Erwachsenen verwenden. Nach dem Spielen austrocknen lassen.
- Nur mitgelieferte PLAYMOBIL Geschosse verwenden. Nicht auf Augen oder Gesicht zielen.

(USA) (GB) (CDN) (M) (IRL) WARNING!

- Only to be used in water in which the child is within its depth and under adult supervision. Dry thoroughly after play.
- Only use the PLAYMOBIL projectiles supplied. Do not aim at eyes or face.

(F) (CDN) (B) (L) (CH) ATTENTION!

- À n'utiliser qu'en eau où l'enfant a pied et sous la surveillance d'un adulte. Faire sécher après chaque utilisation.
- Seulement utiliser les projectiles PLAYMOBIL fournis. Ne pas viser les yeux ou le visage.

(E) (MEX) ¡ADVERTENCIA!

- Utilizar sólo en agua donde el niño pueda permanecer de pie y bajo vigilancia de un adulto. Dejar secar antes de guardar.
- Utiliza únicamente los proyectiles PLAYMOBIL suministrados. No apuntar a los ojos ni a la cara.

(NL) (B) WAARSCHUWING!

- Gebruiken in water waar kinderen kunnen staan en onder toezicht van volwassenen. Na het spelen laten drogen.
- Uitsluitend meegeleverde PLAYMOBIL delen gebruiken. Niet op ogen of gezicht richten.

(I) (CH) AVVERTENZA!

- Da utilizzare unicamente in acqua dove il bambino tocca il fondo con i piedi e sotto la sorveglianza di un adulto. Asciugare bene dopo ogni uso.
- Usare soltanto i proiettili PLAYMOBIL in dotazione. Non mirare agli occhi o al viso.

(P) ATENÇÃO!

- Só utilizar em água onde a criança tenha pé e sob vigilância de adultos. Deixar secar antes de guardar.
- Usar apenas os projecteis PLAYMOBIL juntamente fornecidos. Não apontar para os olhos ou face.

(DK) ADVARSEL!

- Må kun anvendes under opsyn af en voksen og på vanddybder, hvor barnet kan bunde. Lad det tørre ud når du er færdig med at lege.
- Anvend kun de medfølgende PLAYMOBIL projektiler. Sigt ikke mod øjne eller ansigt.

(N) ADVARSEL!

- Skal kun brukes i vann som ikke er for dypt for barnet, og der barnet er under tilsyn. Tørk opp etter at leken er ferdig.
- Benytt kun PLAYMOBIL prosjektil som leveres med. Sikt ikke på ansikt eller øyne.

(S) (FIN) VARNING!

- Får endast användas i vatten där barnet bottnar och under tillsyn av en vuxen. Låt torka efter användandet.
- Använd endast medlevererade PLAYMOBIL-skott. Sikta inte mot ögon eller ansikte.

(FIN) VAROITUS!

- Lelua saa käyttöä vain aikuisen valvonnassa vedessä, jossa lapsi yletty pohjaan. Anna kuivua leikin jälkeen.
- Käytä vain mukana toimitettuja PLAYMOBIL-ammuksia. Ei saa kohdistaa suoraan silmiin tai kasvoihin.

(H) FIGYELMEZTETÉS.

- Csak a gyermek magasságához képest biztonságos sekély vízben és felnőtt felügyelete mellett szabad használni!
- Játék után ajánlott a termék kiszáritása!
- Csak a csomagban található PLAYMOBIL lövedékeket szabad használni. Tilos szemre vagy arcra célozni.

(CZ) UPOZORNĚNÍ!

- Používat pouze ve vodě takové hloubky, kde dítě stačí, a pouze pod dohledem dospělé osoby. Po hraní nechat vyschnout.
- Používejte pouze střely PLAYMOBIL, které jsou součástí dodávky. Nemířte na oči nebo na obličej!

(EST) HOIATUS!

- Kasutada ainult täiskasvanu järelevalve all vees, kus laps ulatub jalgadega põhja. Mängimise järel kuivatada!
- Kasutage ainult kaasaantud PLAYMOBIL'i laskemoona. Ärge sihi silmadesse ega näkku.

(LV) BRĪDINĀJUMS!

- Lietot tikai seklā ūdenī un pieaugušo uzraudzībā. Pēc spēlēšanās ļaut nožūt.
- Izmantot tikai PLAYMOBIL piegādes komplektā iekļautos šāviņus. Nevērst pret acīm vai seju.

(LT) ĮSPĖJIMAS!

- Naudoti tik vaikui tinkamame gylyje ir prižiūrint suaugusiesiems. Pažaidus, išdžiovinkite.
- Naudokite tik pridamus PLAYMOBIL šaudmenis. Netaikyti į akis arba veidą.

(SLO) OPOZORILO!

- Uporabljajte samo v vodi, primerno plitvi za otroka in pod nadzorom odrasle osebe. Po igri naj se igrača posuši.
- Uporabljajte le priložene PLAYMOBIL-ove krogle. Ne merite v oči ali obraz.

(SK) UPOZORNENIE!

- Používať len vo vode, v ktorej dieťa dočiahne na dno, a pod dohľadom dospelých osoby. Po hre nechať vyschnúť.
- Používajte len náboje dodávané spolu so sadou PLAYMOBIL. Nemierť do očí alebo do tváre.

(PL) OSTRZEŻENIE!

- Do używania jedynie w wodzie na głębokości, na której dziecko wyczuwa dno pod nogami oraz pod nadzorem osoby dorosłej. Po zabawie pozostaw do wyschnięcia.
- Stosować tylko załączone PLAYMOBIL - kule / pociski. Nie celować w oczy i twarz.

(TR) (CY) DİKKAT!

- Sadece denetim altında ve sadece alçak sularda kullanın. Oyundan sonra kurumaya bırakın.
- Sadece birlikte verilen PLAYMOBIL mermileri kullanınız. Göze veya yüze doğru tutmayınız.

(GR) (CY) Προειδοποίηση!

- Να χρησιμοποιείται μόνο σε νερά όπου πατώνει το παιδί και υπό την επίβλεψη ενηλίκου. Μόλις τελειώσετε, αφήστε το παιχνίδι να στεγνώσει εντελώς.
- Να χρησιμοποιούνται αποκλειστικά τα βλήματα της PLAYMOBIL που περιέχονται στη συσκευασία. Μη μην γίνεται στόχευση στα μάτια ή στο πρόσωπο.

(RO) AVERTISMENT!

- A se utilizeza numai acolo unde copilul poate sta în picioare în apă și este sub supraveghere. După joacă se lasă să se usuce.
- Se folosesc doar proiectilele incluse PLAYMOBIL. Nu se țintesc în ochi sau în față.

(BG) Внимание!

- Да се използва само във вода, която е дълбока до нормалния ръст на детето, и под надзора на възрастен. След игра оставете да изсъхне.
- Използвайте само приложени PLAYMOBIL снаряди. Не насочвайте към очите и лицето.

(HR) UPOZORENJE!

- Koristiti samo u plitkoj vodi pod nadzorom odraslih. Poslije igranja pustiti da se osuši.
- Upotrijebiti samo od strane PLAYMOBIL-a isporučene projekte. Ne ciljati u oči ili lice.

(CN) 警告!

- 可供孩子在水中使用的，但必须在有人监护的情况下。玩耍后要干燥。
- 仅能用PLAYMOBIL的炮弹。禁止瞄准眼睛或脸。请勿瞄准眼睛或脸。

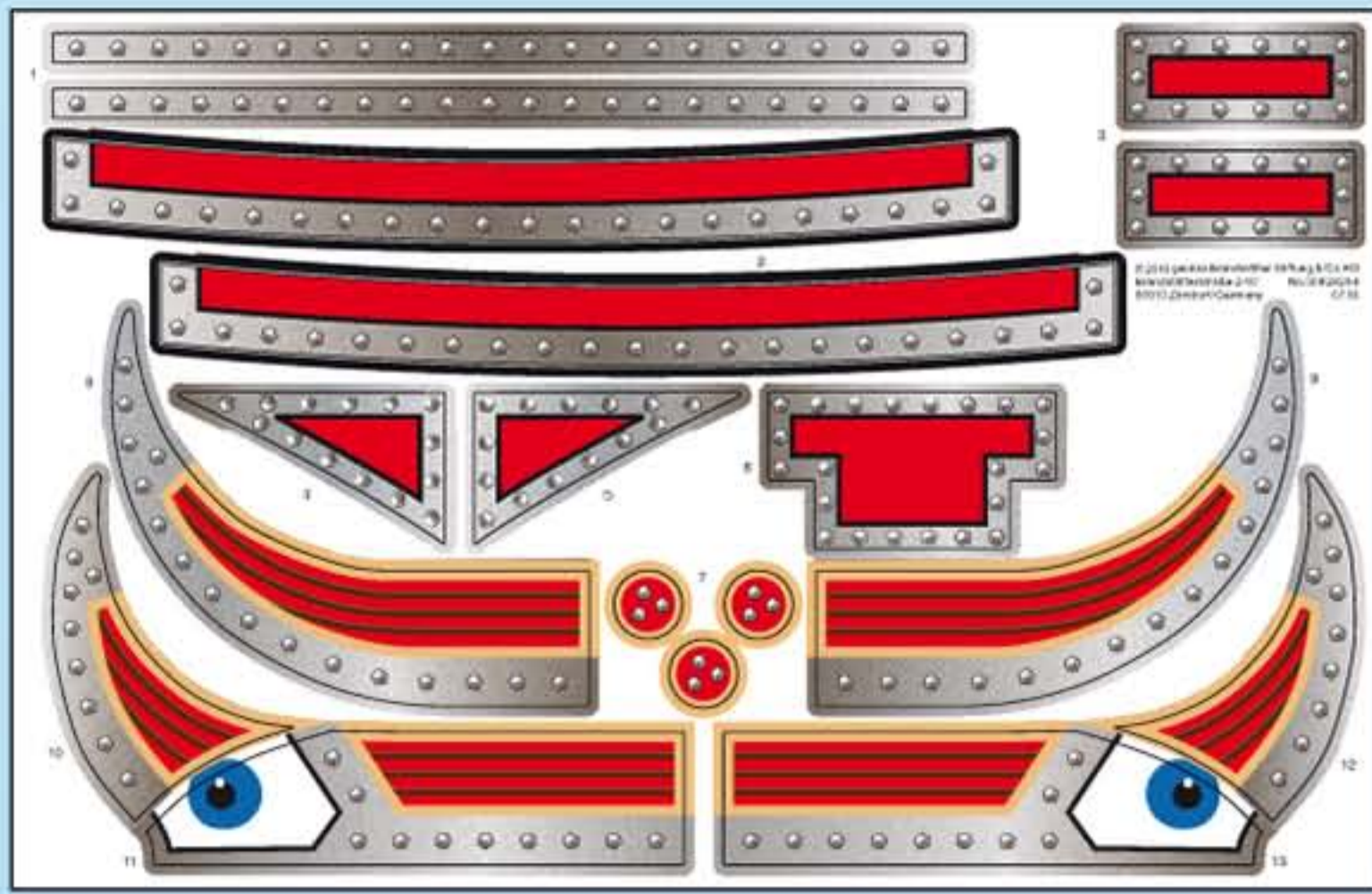

30 82 8204



30 82 8214



30 46 9742



30 45 0412

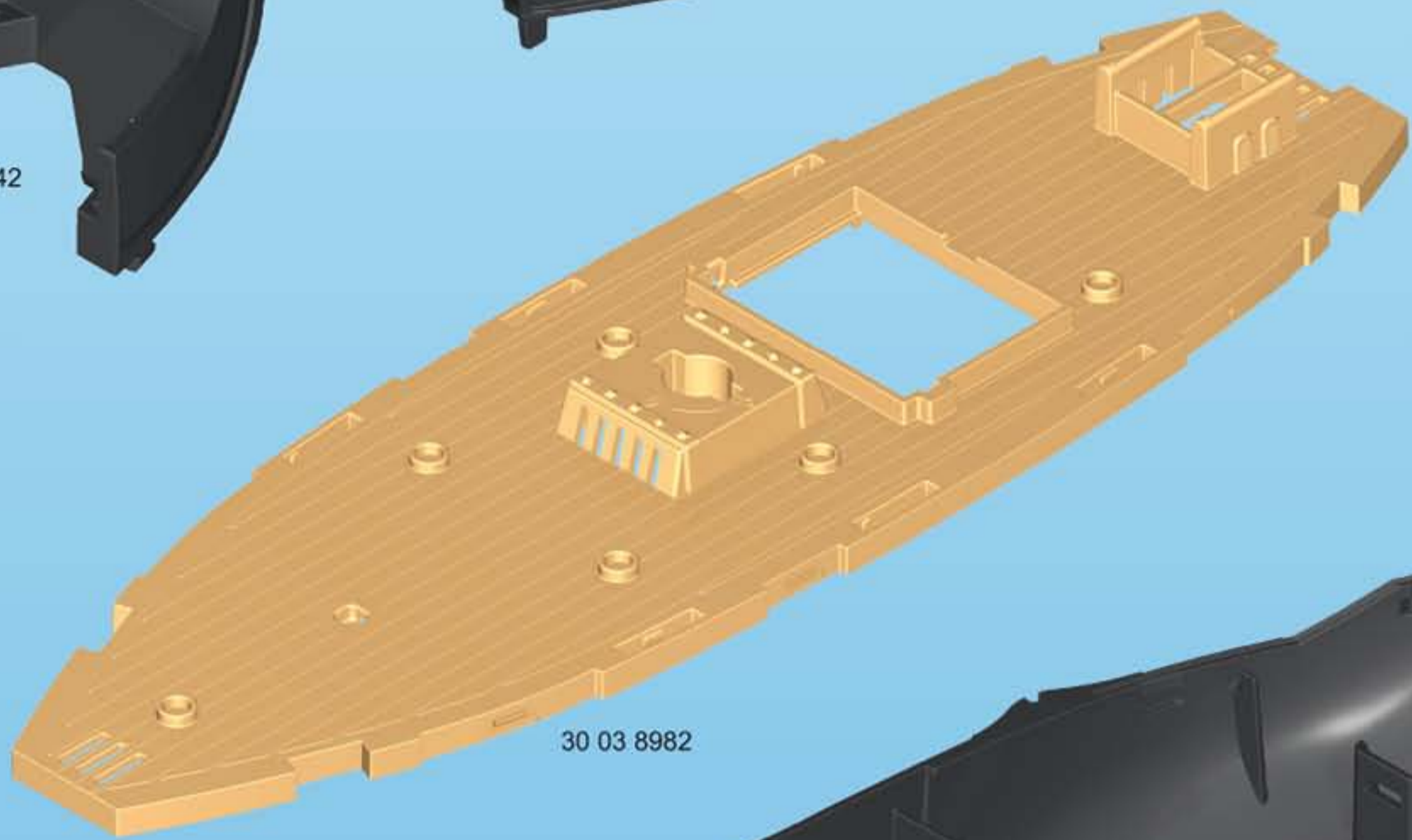

30 03 8982



30 03 9082

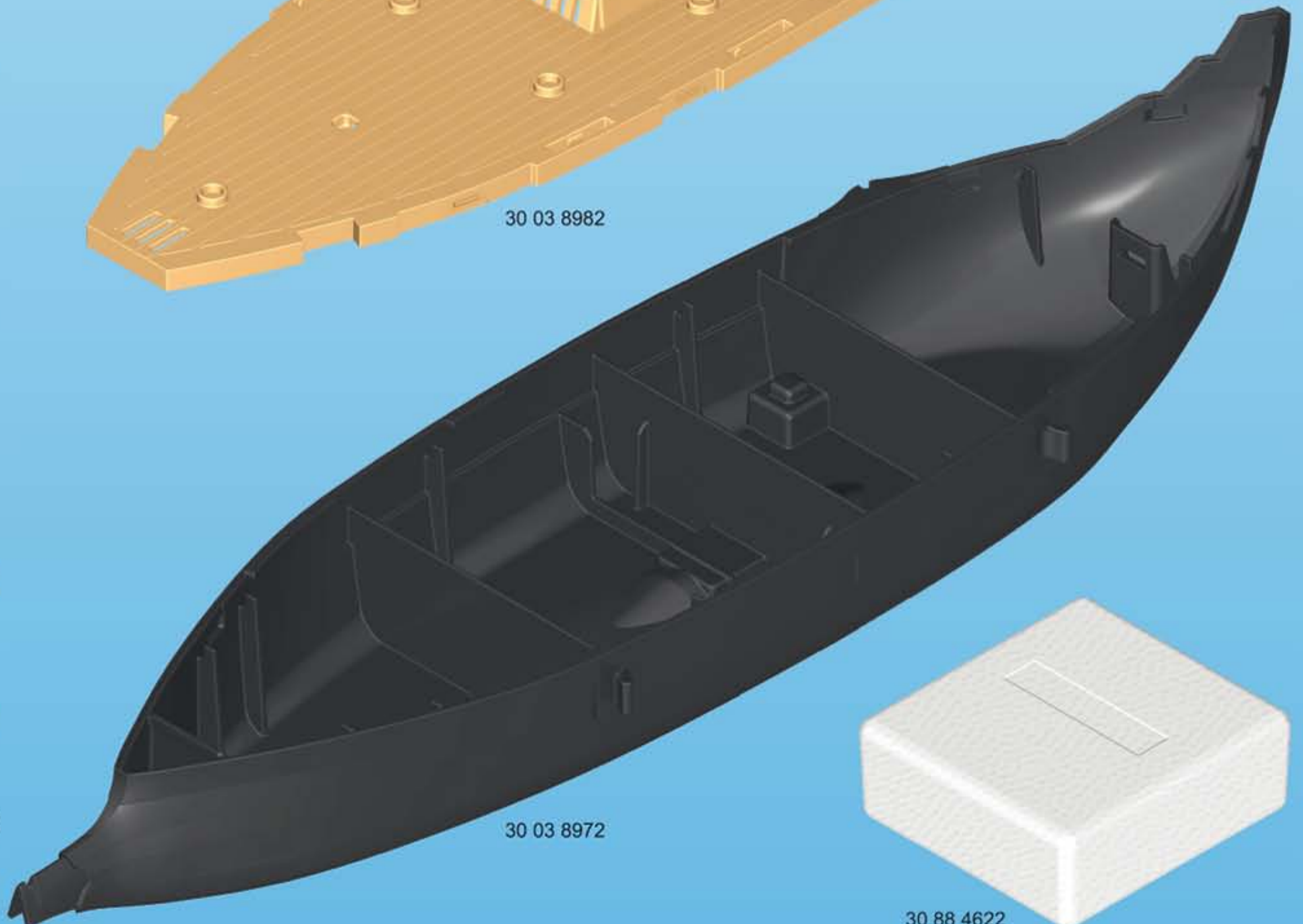

30 03 8972



30 88 4622

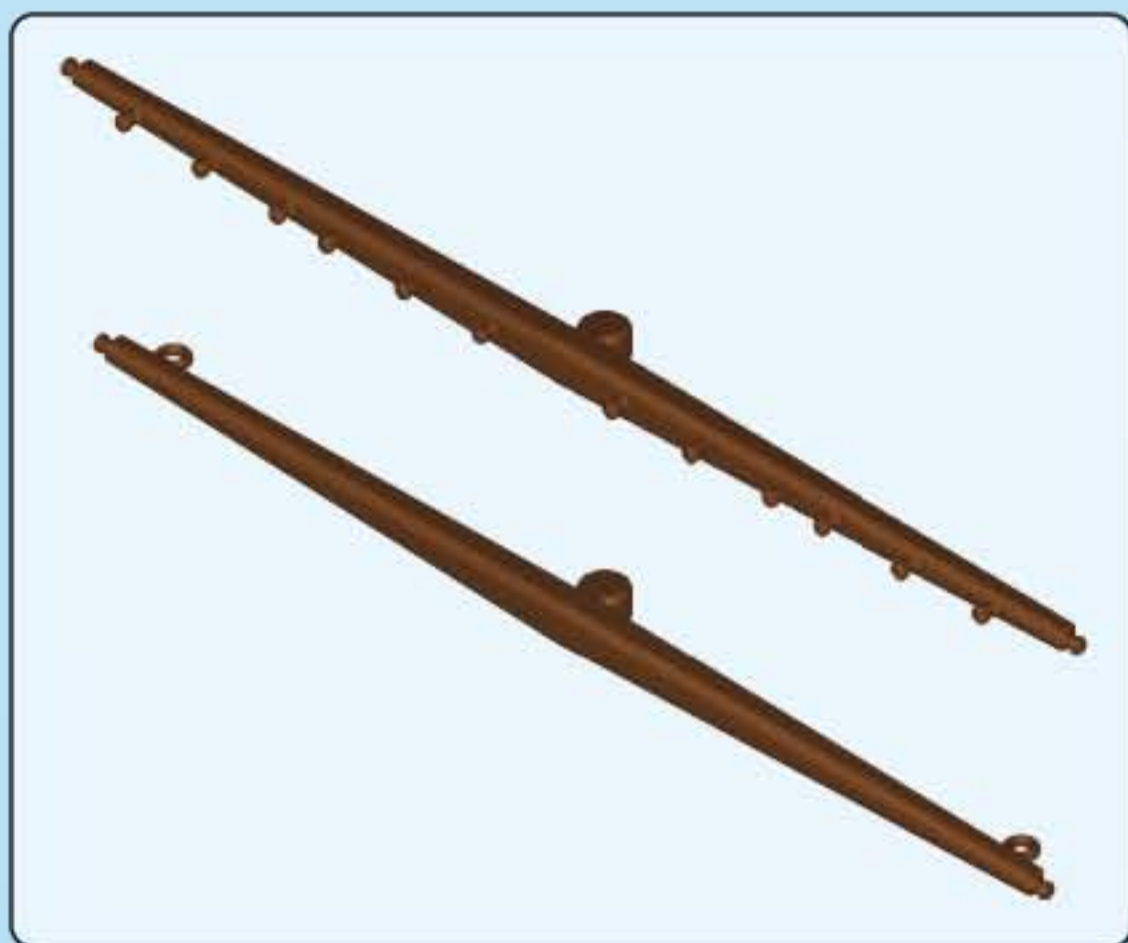

30 61 0482



30 26 5700



2x 30 26 7010

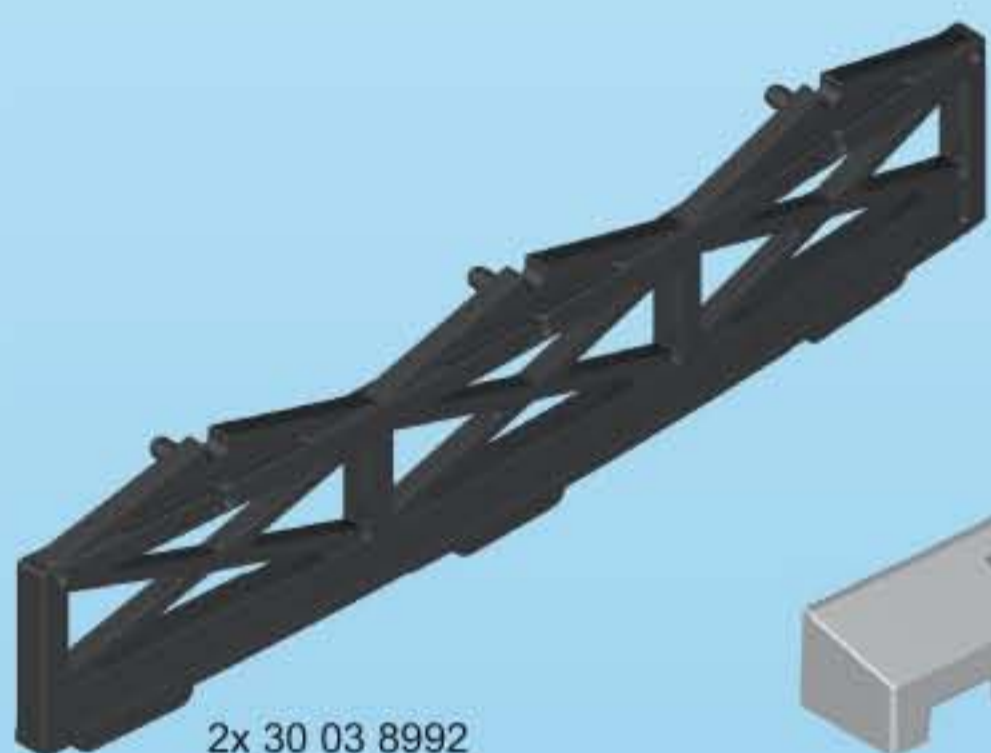

2x 30 03 8992

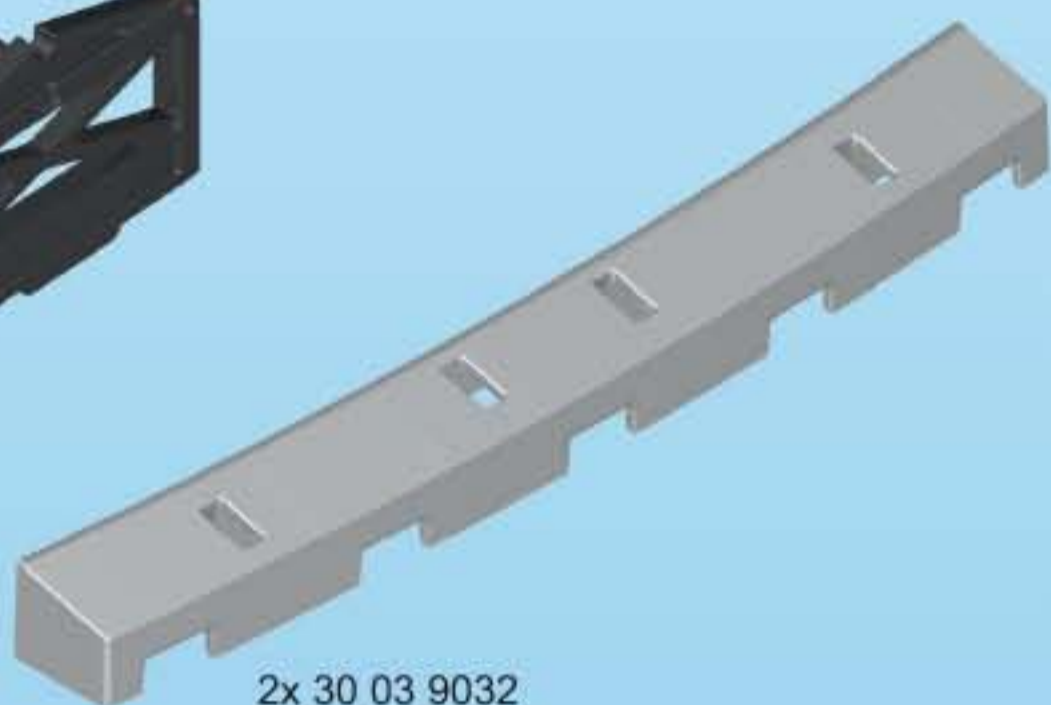

2x 30 03 9032



30 26 5820

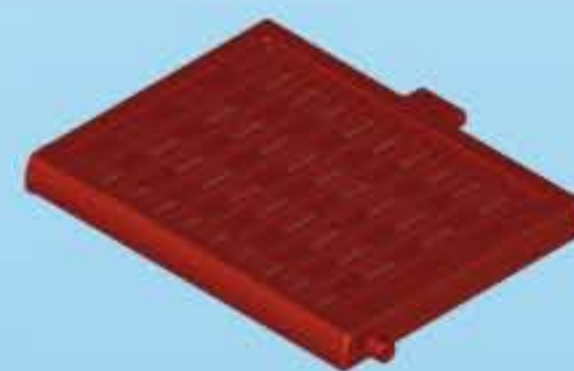

30 03 9012



30 03 9072



6x 30 64 4184



30 62 1405



30 29 2500



30 21 7083



30 26 7040



2x 30 03 9102



5x 30 20 4560



30 03 9092



30 03 9062



3x 30 03 9042



30 63 1912



30 03 9002



2x 30 21 7882



30 26 7030



30 03 9022



2x 30 09 9300



2x 30 22 8890



30 89 5422



4x 30 23 5040



30 03 9052



2x 30 26 6990



2x 30 09 3780



30 09 6760



30 20 5050



3x 30 63 3042



2x 30 26 6980



30 22 8250

