

playmobil®

5169



WARNING: CHOKING HAZARD

Small parts. Not for children under 3 years.

"Ne concerne que les USA"

Wichtige Unterlagen, bitte sorgfältig aufbewahren!
Important: Please keep these instructions for future reference!
Documents importants, à conserver soigneusement!
Belangrijke documenten, bewaar deze zorgvuldig!

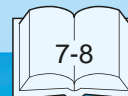

1

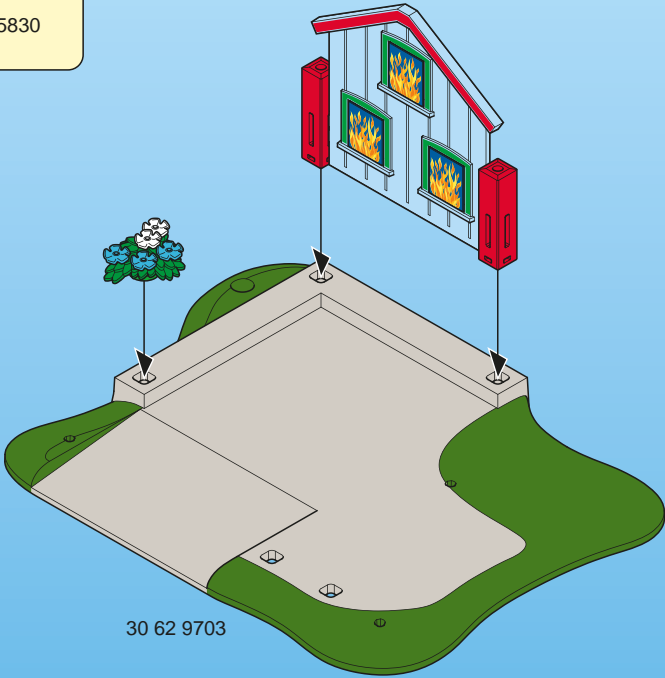
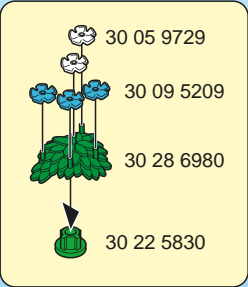
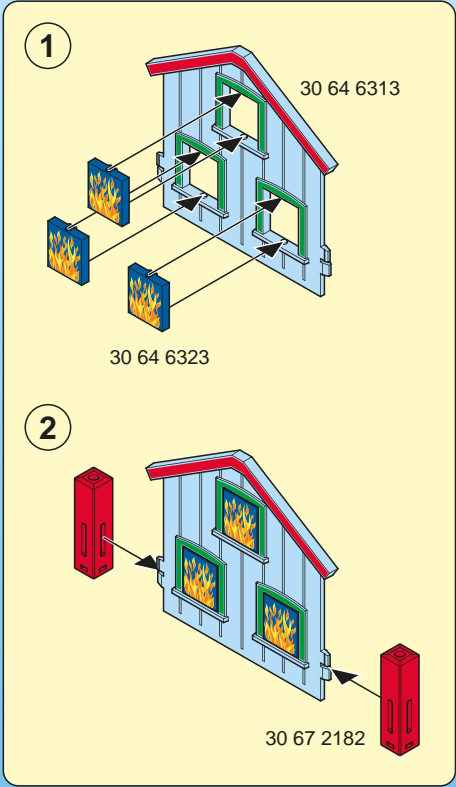

2

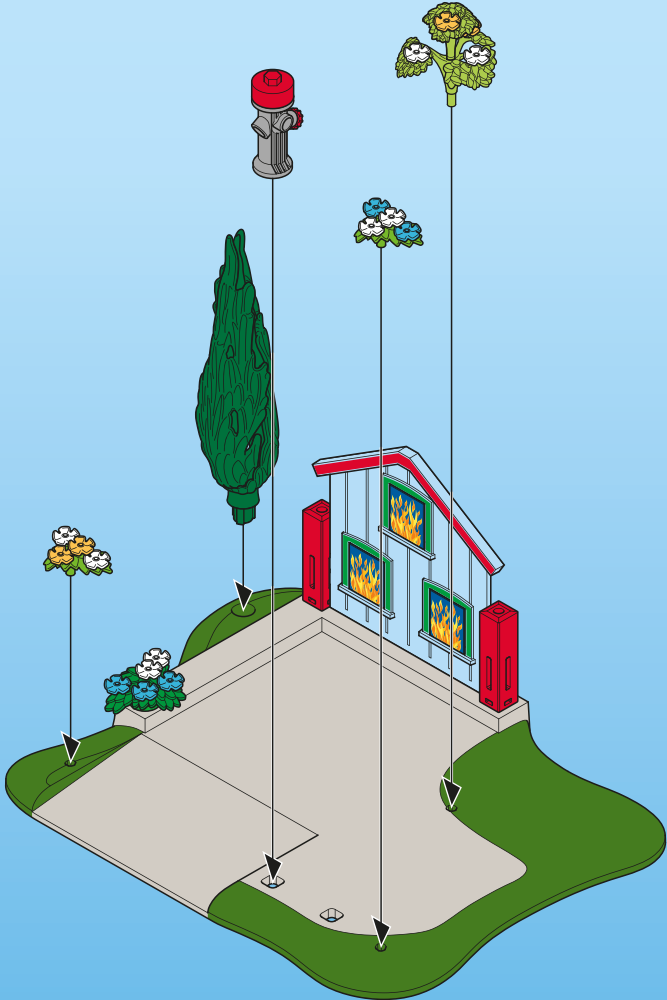
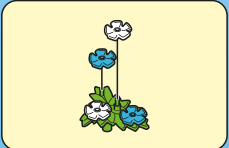
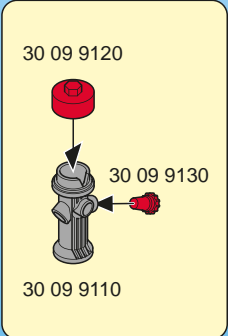
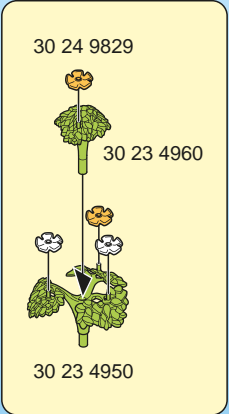
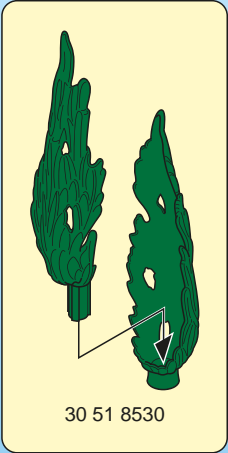

3

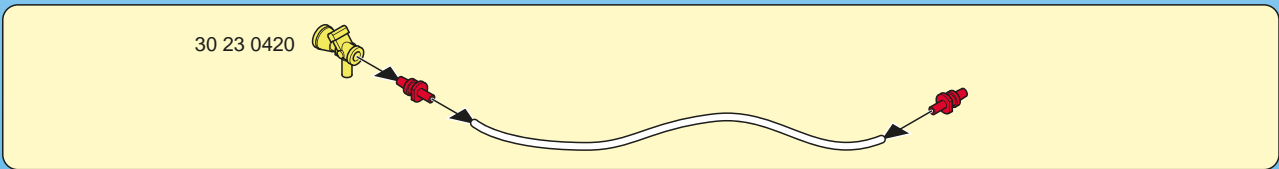
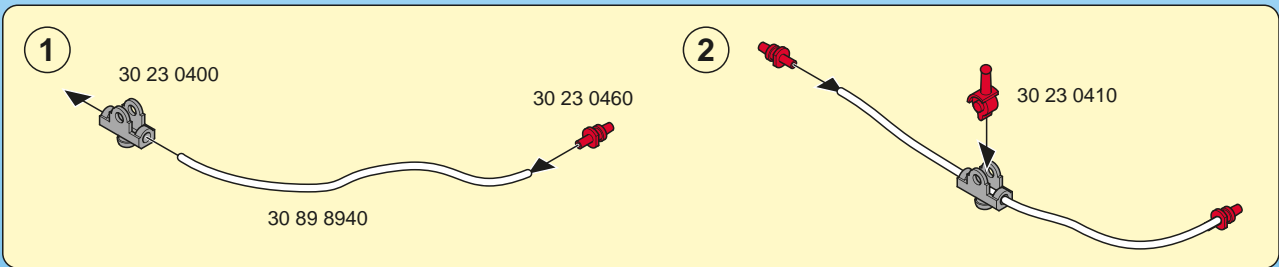
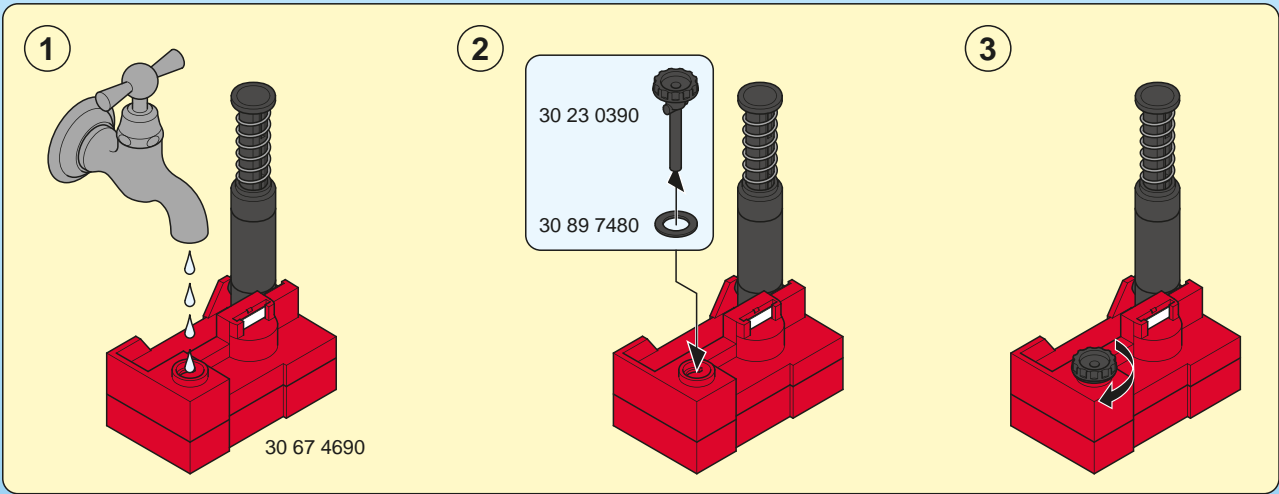

4

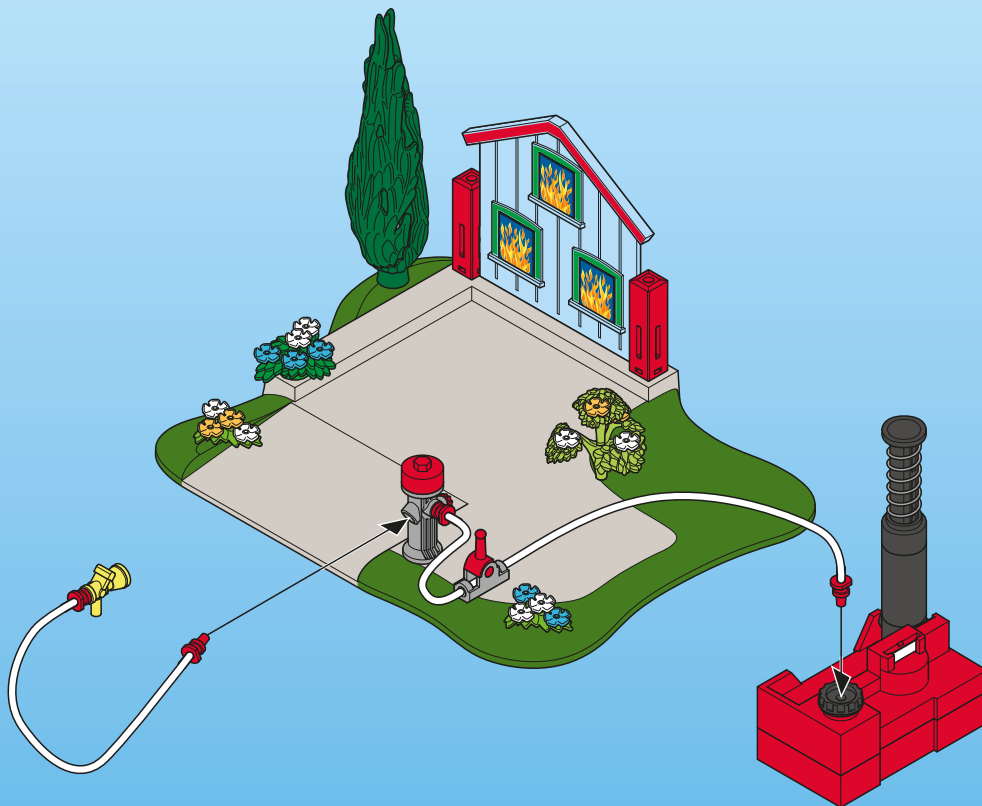

DE AT CH LU BE ACHTUNG! Nicht auf Augen oder Gesicht zielen. Nur Trinkwasser verwenden. Nach dem Spielen austrocknen lassen.

US GB CA MT IE WARNING! Do not aim at eyes or face. Use only tap water. Dry thoroughly after play.

FR CA BE LU CH ATTENTION! Ne pas viser les yeux ou le visage. N'utiliser que de l'eau potable. Faire sécher après chaque utilisation.

ES MX ¡ADVERTENCIA! No apuntar a los ojos ni a la cara. Utilizar solamente agua potable. Dejar secar antes de guardar.

NL BE WAARSCHUWING! Niet op ogen of gezicht richten. Enkel drinkbaar water gebruiken. Na het spelen laten drogen.

IT CH AVVERTENZA! Non mirare agli occhi o al viso. Usare solo acqua potabile. Asciugare bene dopo ogni uso.

PT ATENÇÃO! Não apontar para os olhos ou face. Utilizar somente água potável. Deixar secar antes de guardar.

DK ADVARSEL! Sigt ikke mod øjne eller ansigt. Anvend kun drikkevand. Lad det tørre ud når du er færdig med at lege.

NO ADVARSEL! Sikt ikke på ansikt eller øyne. Kun drikkevann skal benyttes. Tørk opp etter at leken er ferdig.

SE FI VARNING! Sikta inte mot ögon eller ansikte. Använd endast dricksvatten. Låt torka efter användandet.

FI VAROITUS! Ei saa kohdistaa suoraan silmiin tai kasvoihin. Käytä ainoastaan juomavettä. Anna kuivua leikin jälkeen.

HU FIGYELMEZTETÉS. Tilos szemre vagy arcra célozni. Kérjük kizárólag ivóvizet használnjon! Játék után ajánlott a termék kiszáritása!

CZ UPOZORNĚNÍ! Nemířte na oči nebo na obličej! Používejte jen pitnou vodu. Po hraní nechat vyschnout.

EE HOIATUS! Ära sihi silmadesse ega näkku. Kasutada üksnes joogivett! Mängimise järel kuivatada!

LV BRĪDINĀJUMS! Nevērst pret acīm vai seju. Izmantot tikai dzeramo ūdeni. Pēc spēlēšanās ļaut nožūt.

LT ĮSPĖJIMAS! Netaikyti į akis arba veidą. Naudokite tik geriamąjį vandenį. Pažaidus, išdžiovinkite.

SI OPOZORILO! Ne merite v oči ali obraz. V igračo vlivajte le pitno vodo. Po igri naj se igrača posuši.

SK UPOZORNENIE! Nemieriť do očí alebo do tváre. Používať iba pitnú vodu. Po hre nechať vyschnúť.

PL OSTRZEŻENIE! Nie celować w oczy i twarz. Używaj tylko wodę pitną. Po zabawie pozostaw do wyschnięcia.

TR CY DİKKAT! Göze veya yüze doğru tutmayınız. Sadece içme suyu kullanınız. Oyundan sonra kurumaya bırakın.

GR CY Προειδοποίηση! Μη μην γίνεται στόχευση στα μάτια ή στο πρόσωπο. Χρησιμοποιείστε μόνο νερό βρύσης. Μόλις τελειώσετε, αφήστε το παιχνίδι να στεγνώσει εντελώς.

RO AVERTISMENT! Nu se țintește în ochi sau în față. Se folosește doar apă potabilă. După joacă se lasă să se usuce.

BG Внимание! Не насочвайте към очите и лицето. Използвайте само питейна вода. След игра оставете да изсъхне.

HR UPOZORENJE! Ne ciljati u oči ili lice. Koristiti samo pitku vodu. Poslije igranja pustiti da se osuši.

RU Внимание! Не цельтесь в глаза или лицо. Используйте только питьевую воду. Дайте высохнуть после игры.

CN 警告! 请勿瞄准眼睛或脸。仅使用饮用水。玩耍后要干燥。

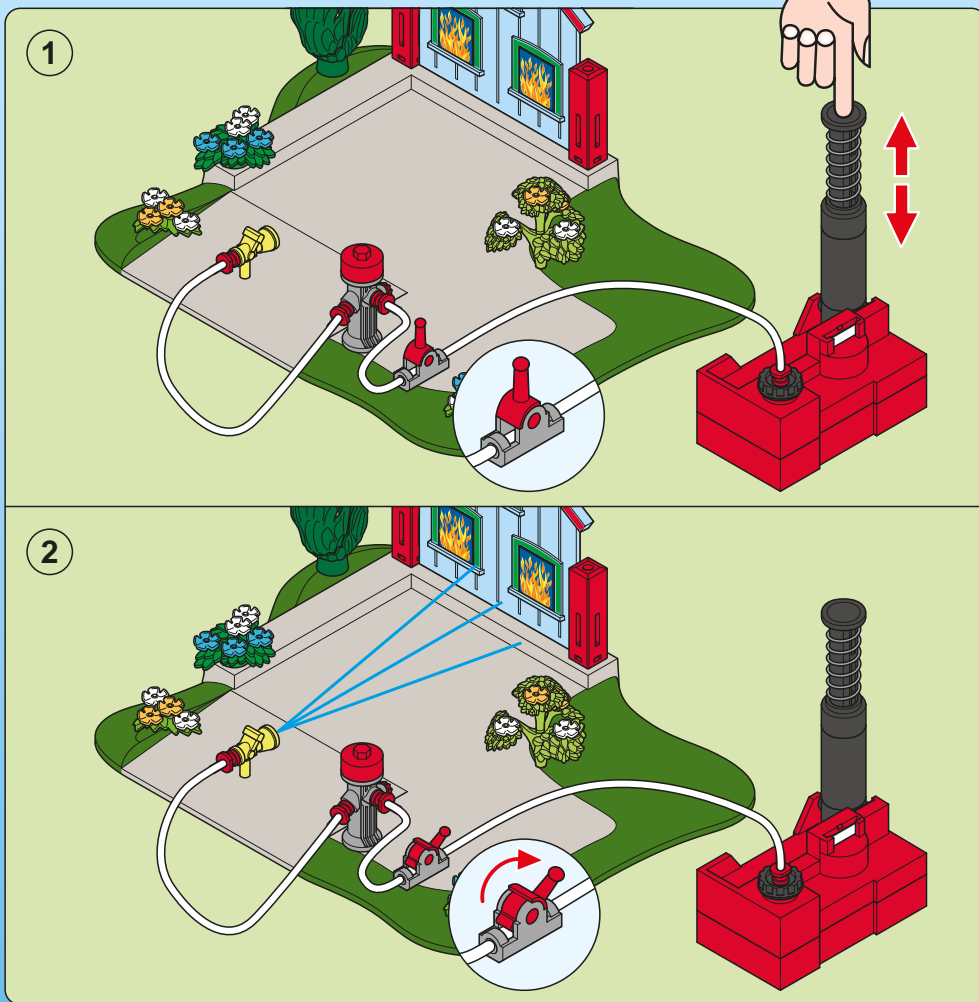

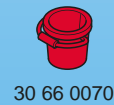
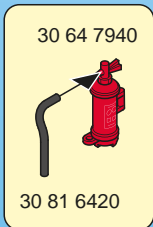

1

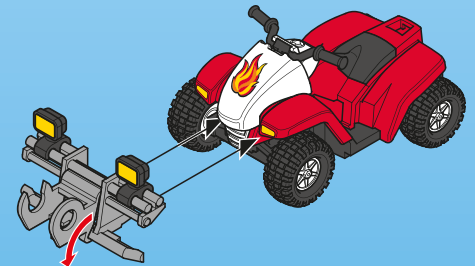
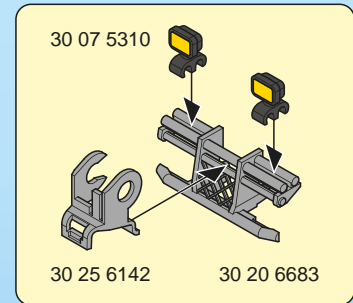

2

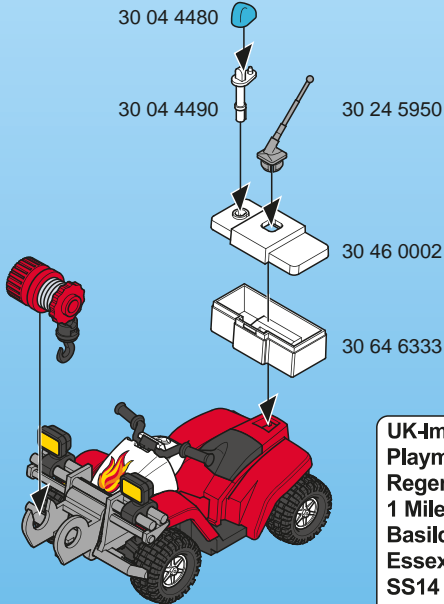
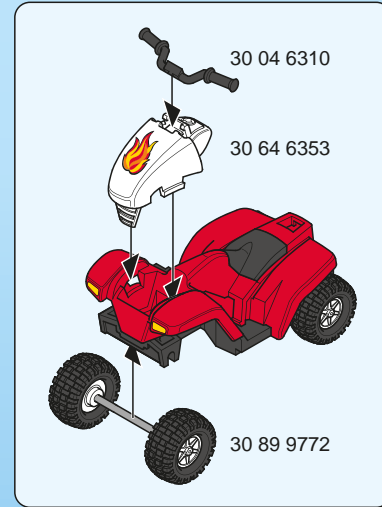
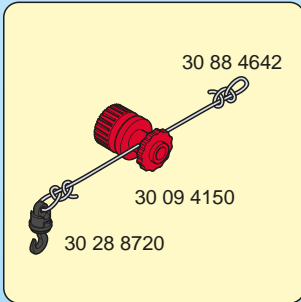

UK-Importer:
Playmobil UK Ltd.
Regency House
1 Miles Gray Road
Basildon
Essex
SS14 3RW
UK

UK
CA

Serviceadressen finden Sie in allen PLAYMOBIL-Prospekten
 Addresses of Customer Service Departments are shown in all PLAYMOBIL catalogues
 L'adresse du service consommateurs est indiquée dans tous les catalogues PLAYMOBIL

Troverete gli indirizzi dei centri di assistenza in tutti i cataloghi PLAYMOBIL pronounced: plāy-mō-bēil

In alle PLAYMOBIL catalogi vindt u het adres van onze klantendienst.
 Las Direcciones de los Departamentos de Servicio al Consumidor se encuentran en todos los catálogos PLAYMOBIL.
 Η διεύθυνση του γραφείου Εξυπηρέτησης Καταναλωτών PLAYMOBIL βρίσκεται σε όλους τους καταλόγους PLAYMOBIL.



© 2013 geobra Brandstätter Stiftung & Co.KG
 Brandstätterstr. 2-10
 90513 Zirndorf, Germany.
 No. 30 80 0936 12.20

www.playmobil.com