

Wichtige Unterlagen, bitte sorgfältig aufbewahren!
Important: Please keep these instructions for future reference!
Documents importants, à conserver soigneusement!
Belangrijke documenten, bewaar deze zorgvuldig!



WARNING:
CHOKING HAZARD

Small parts. Not for children under 3 years.

Ne concerne que les USA



1

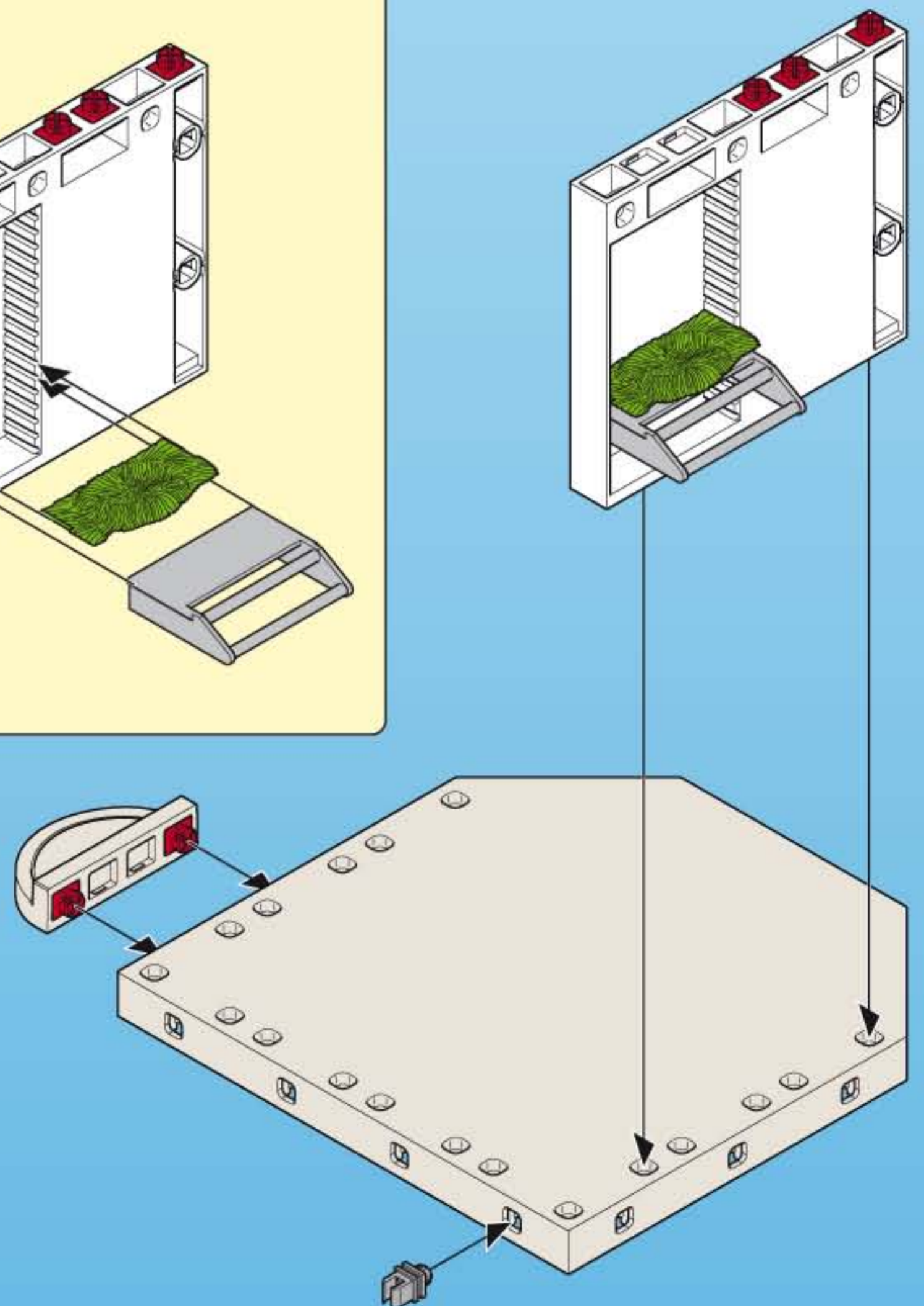
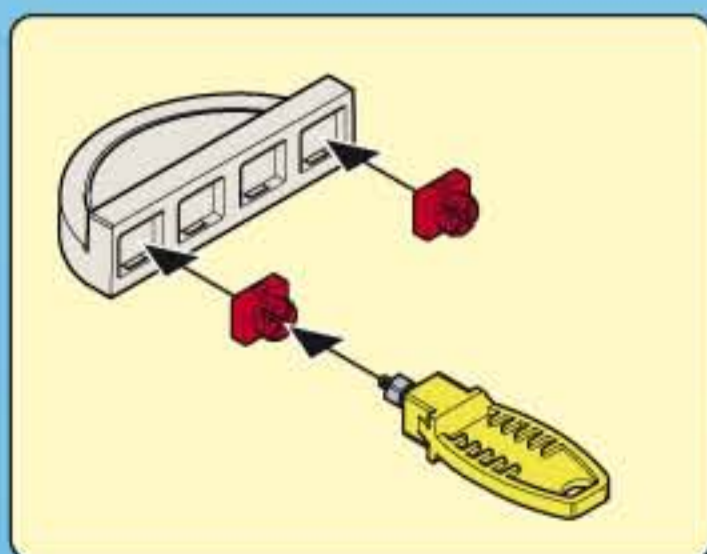
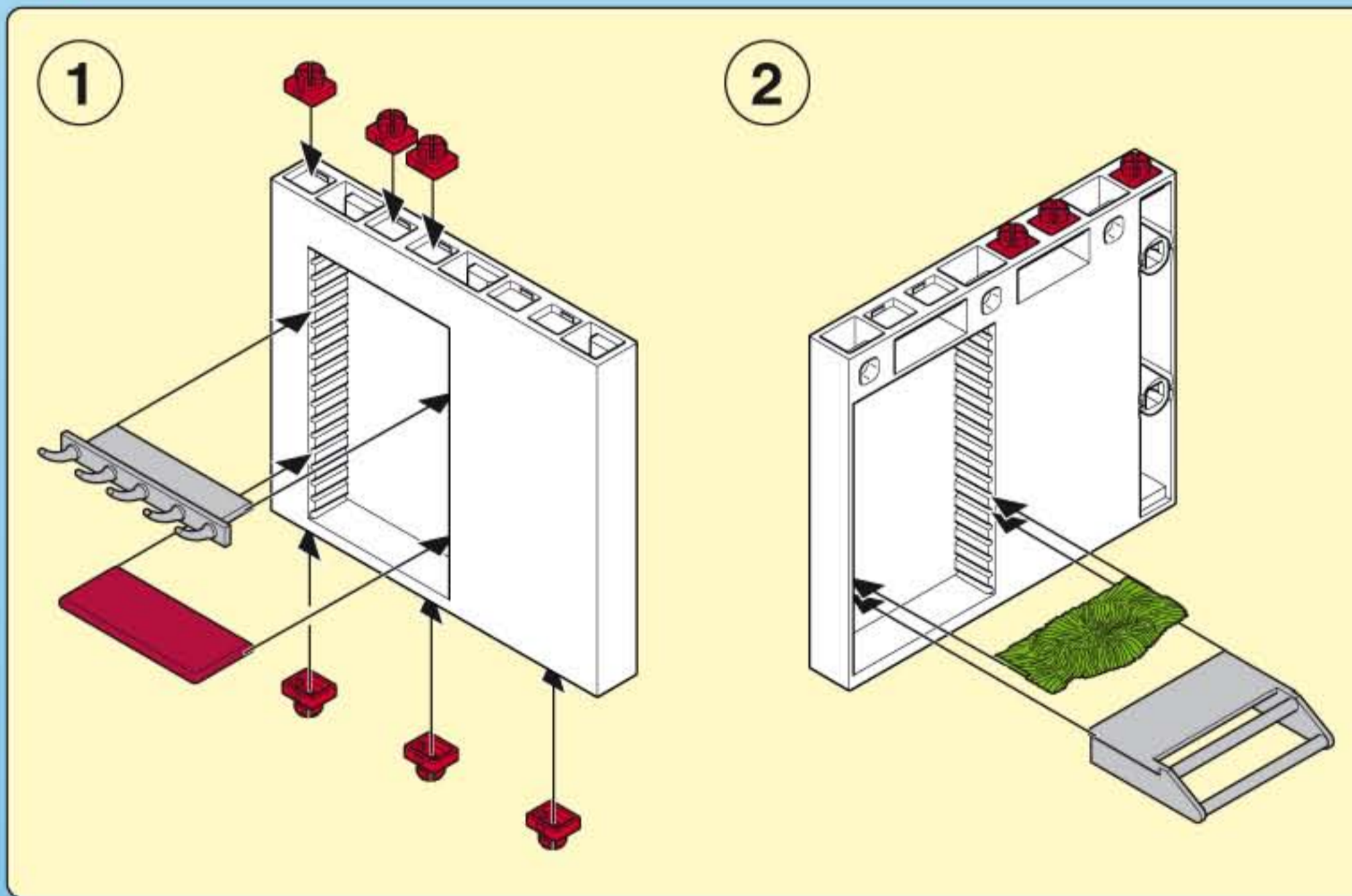

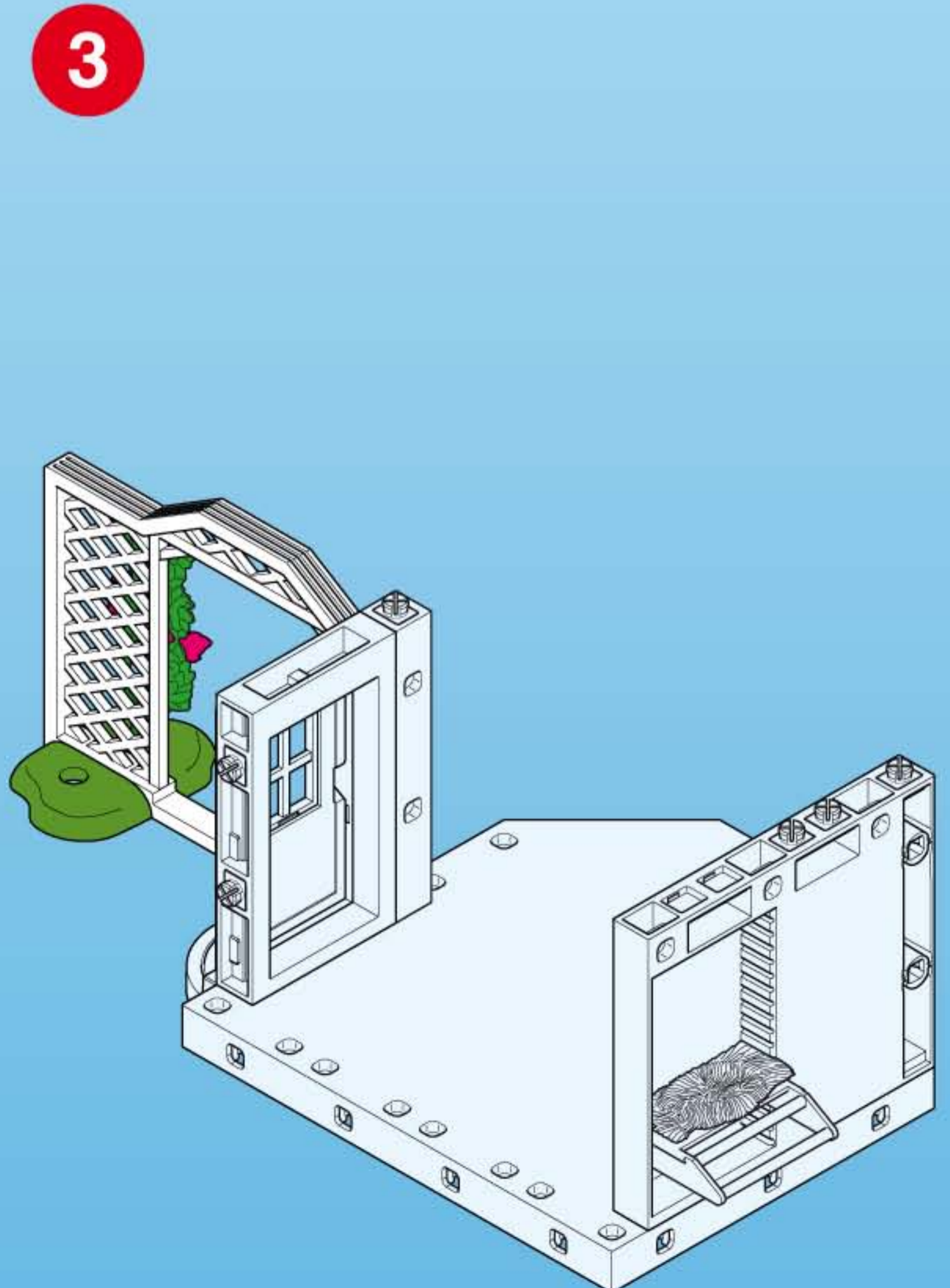
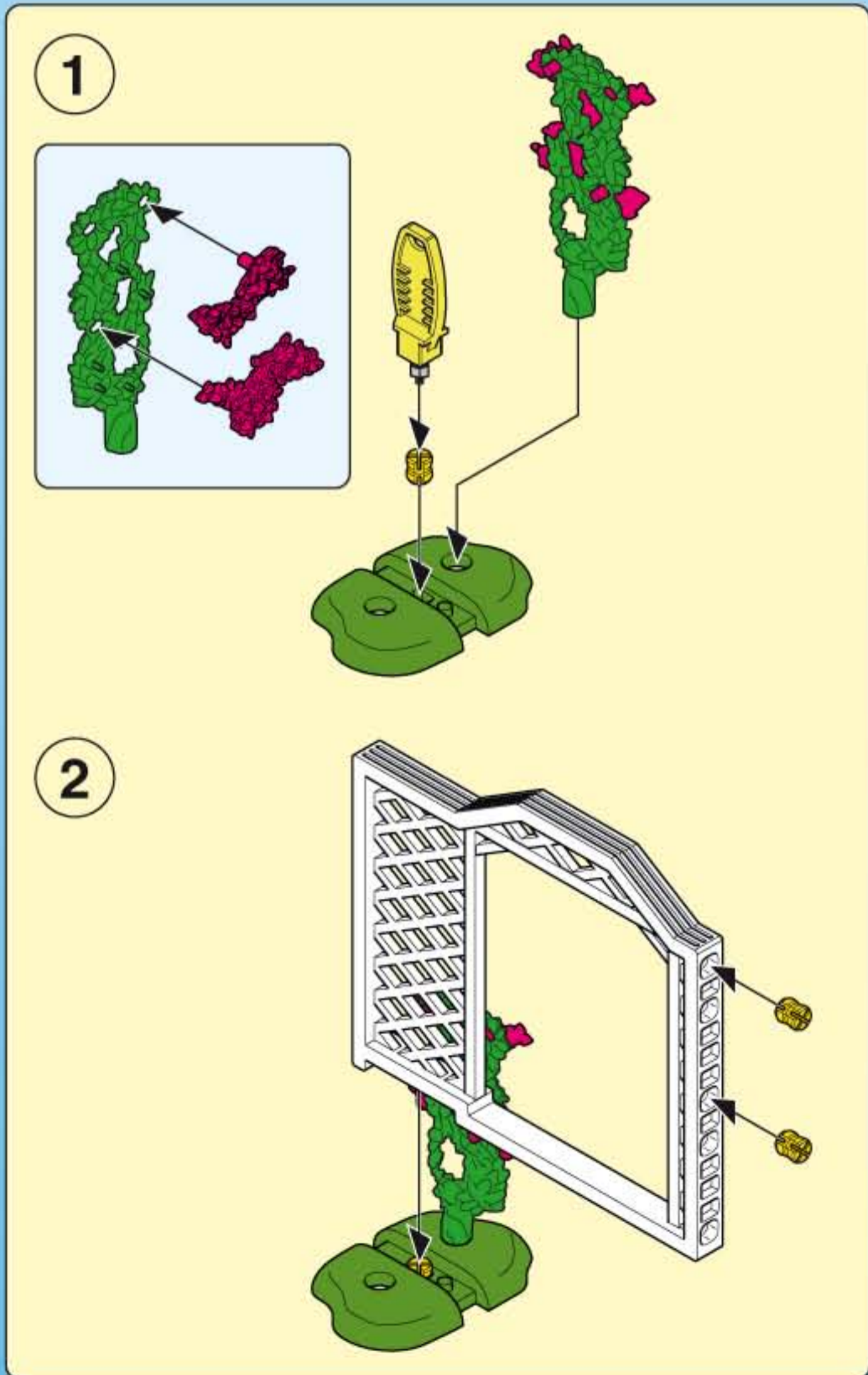
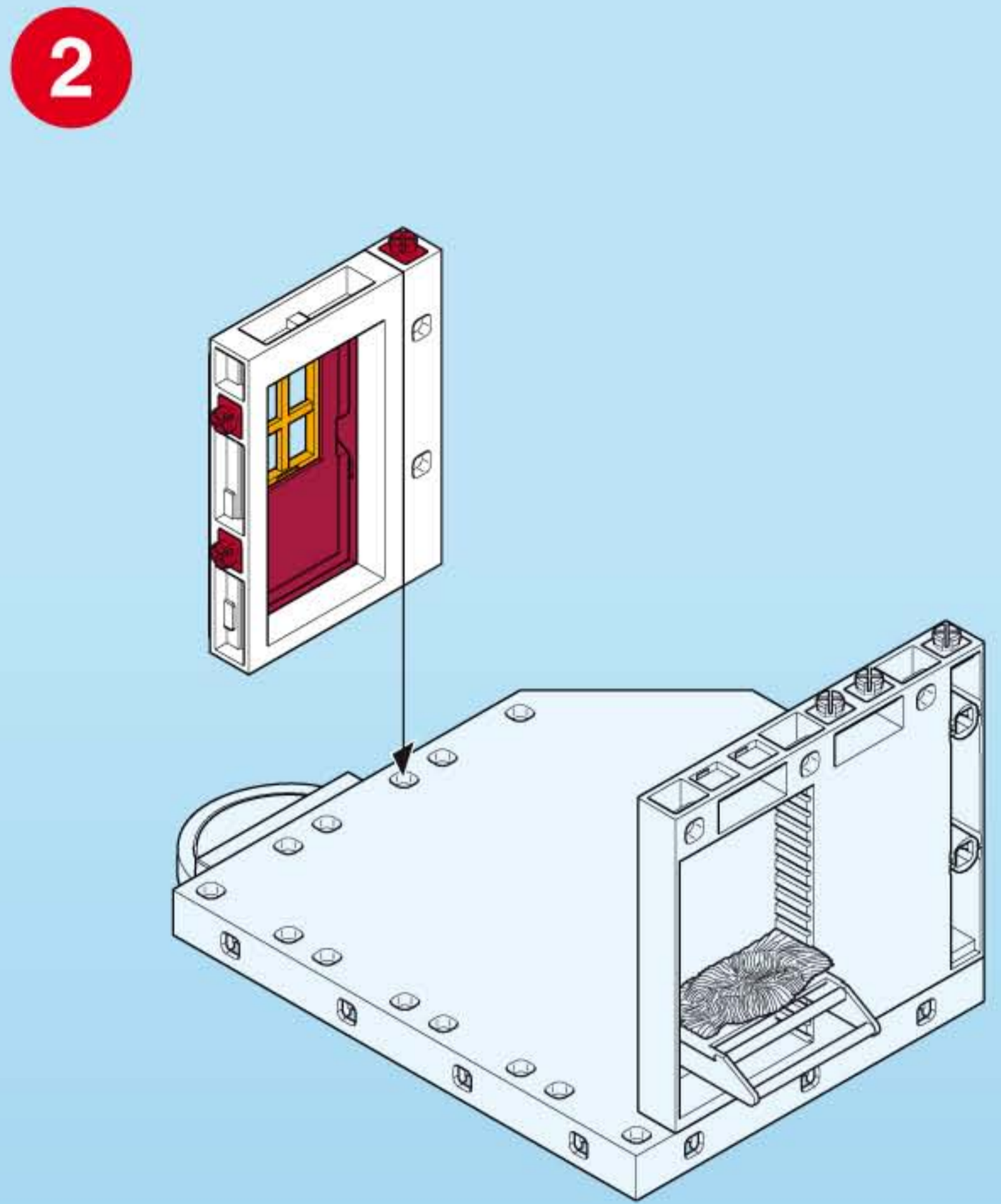
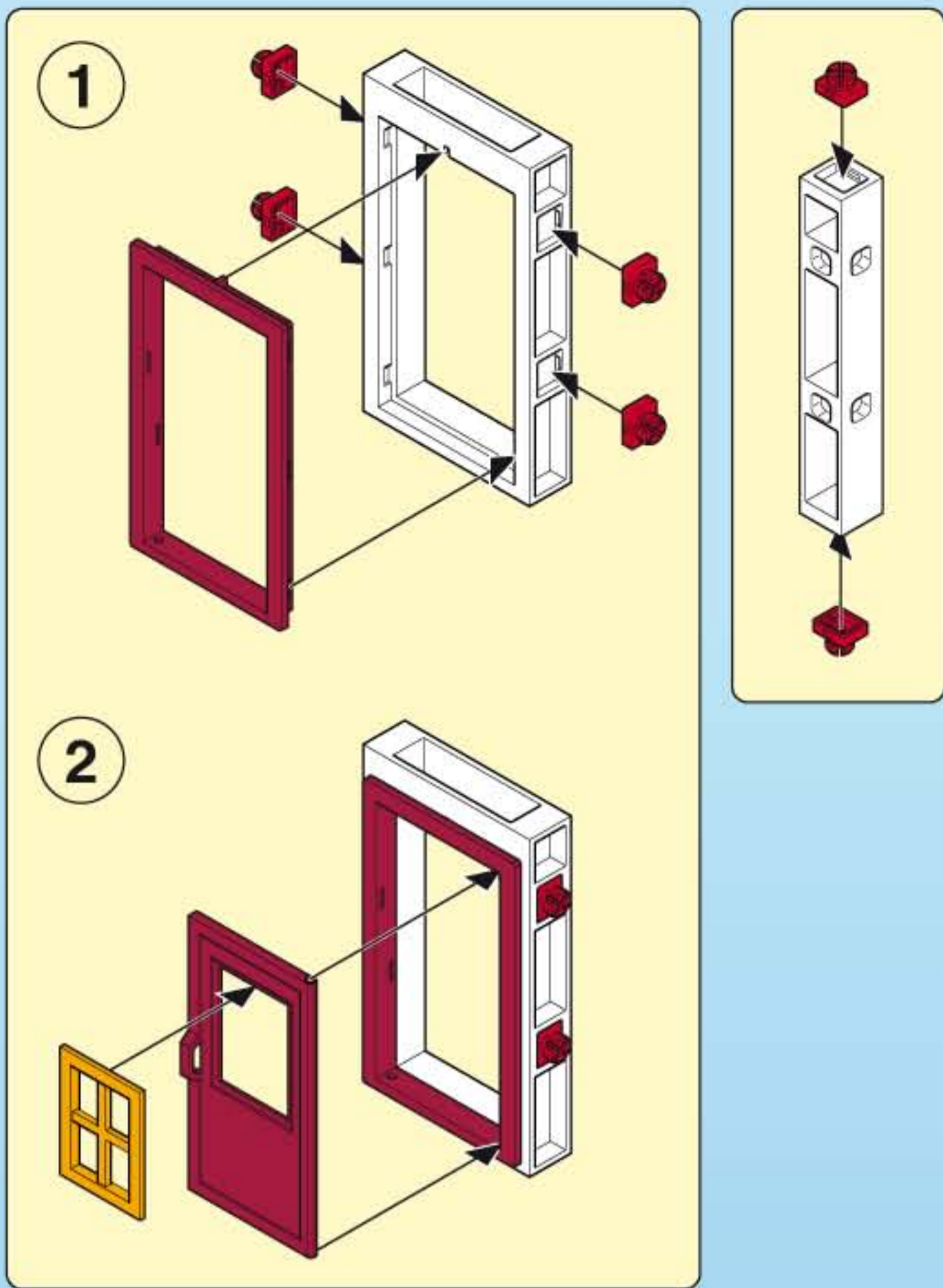

4

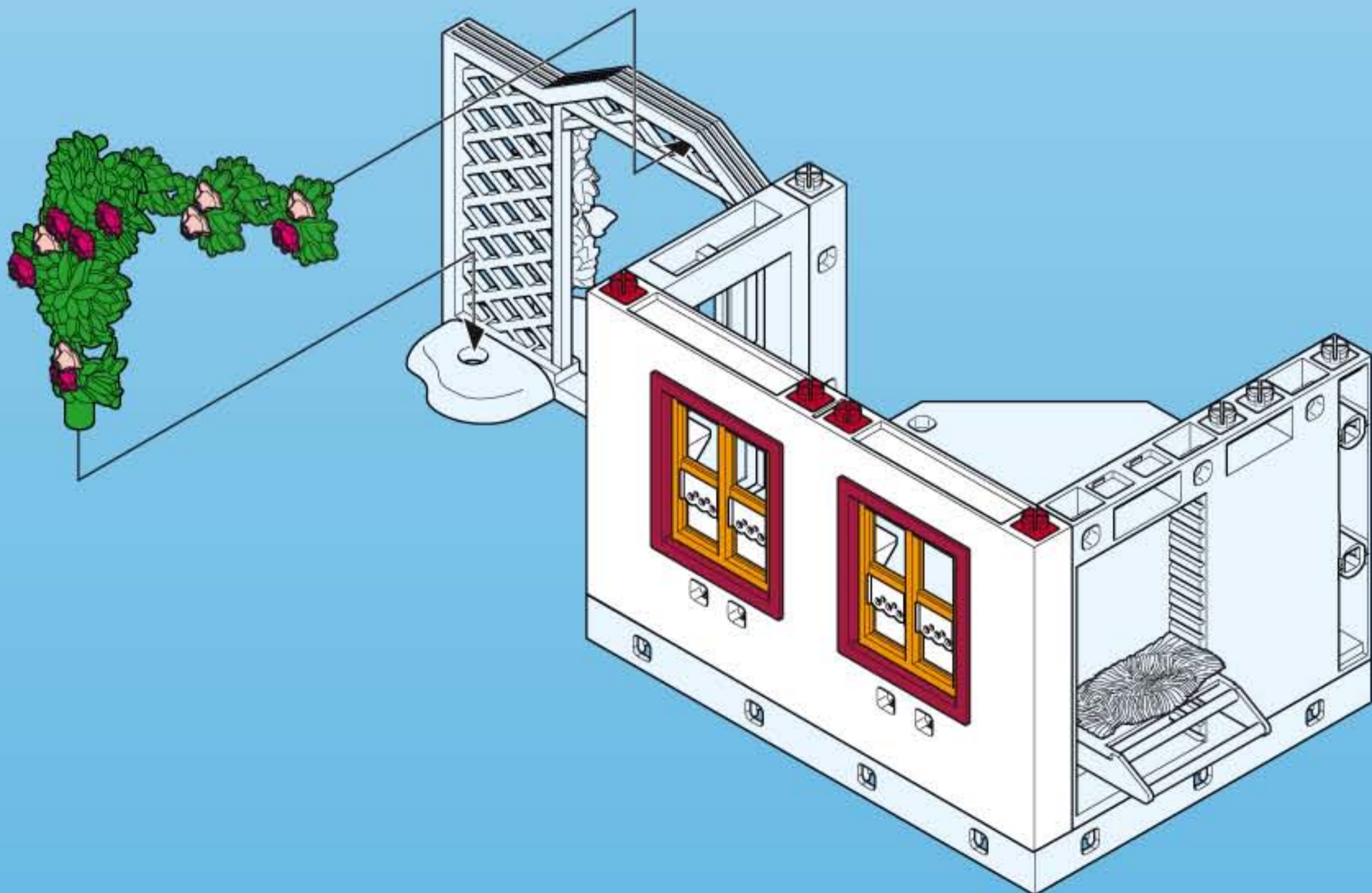
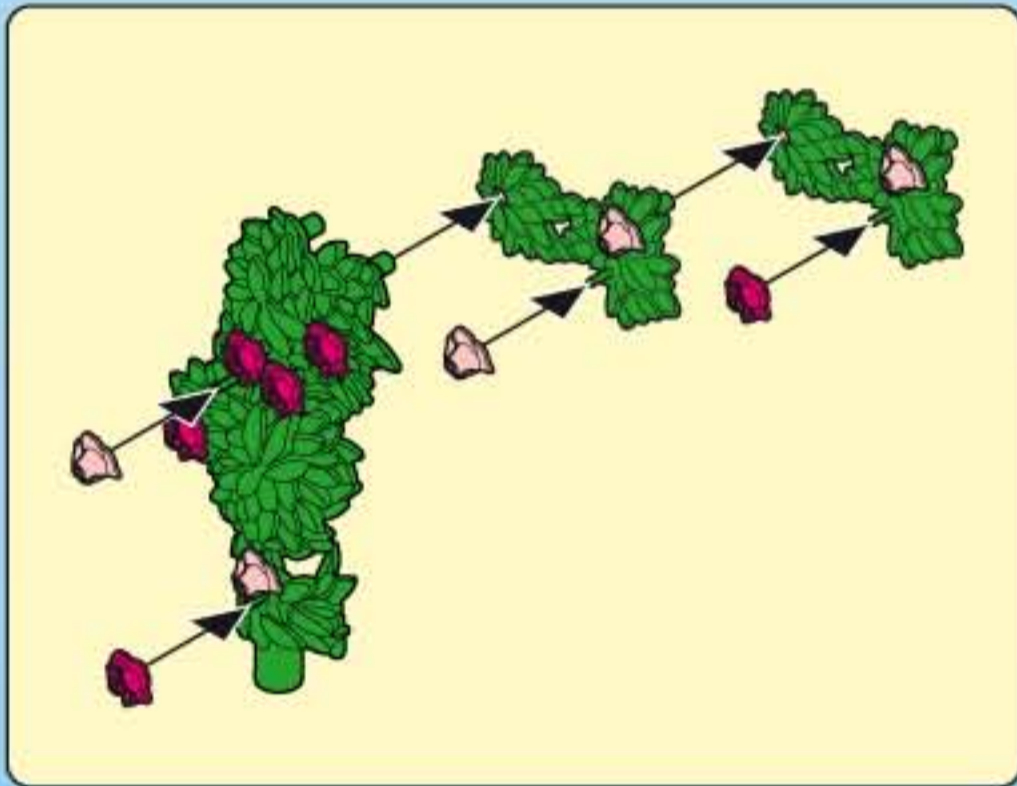
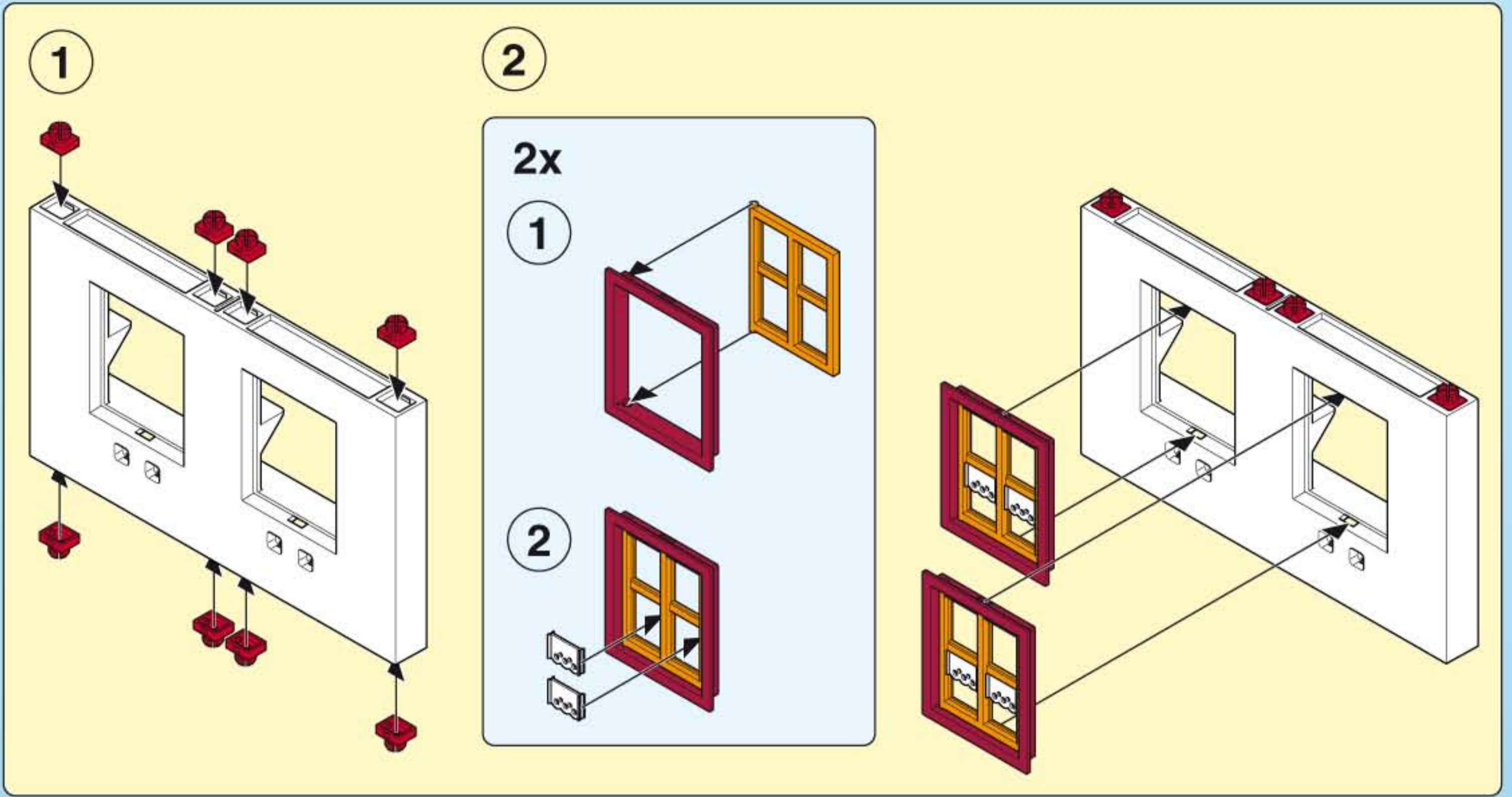

5

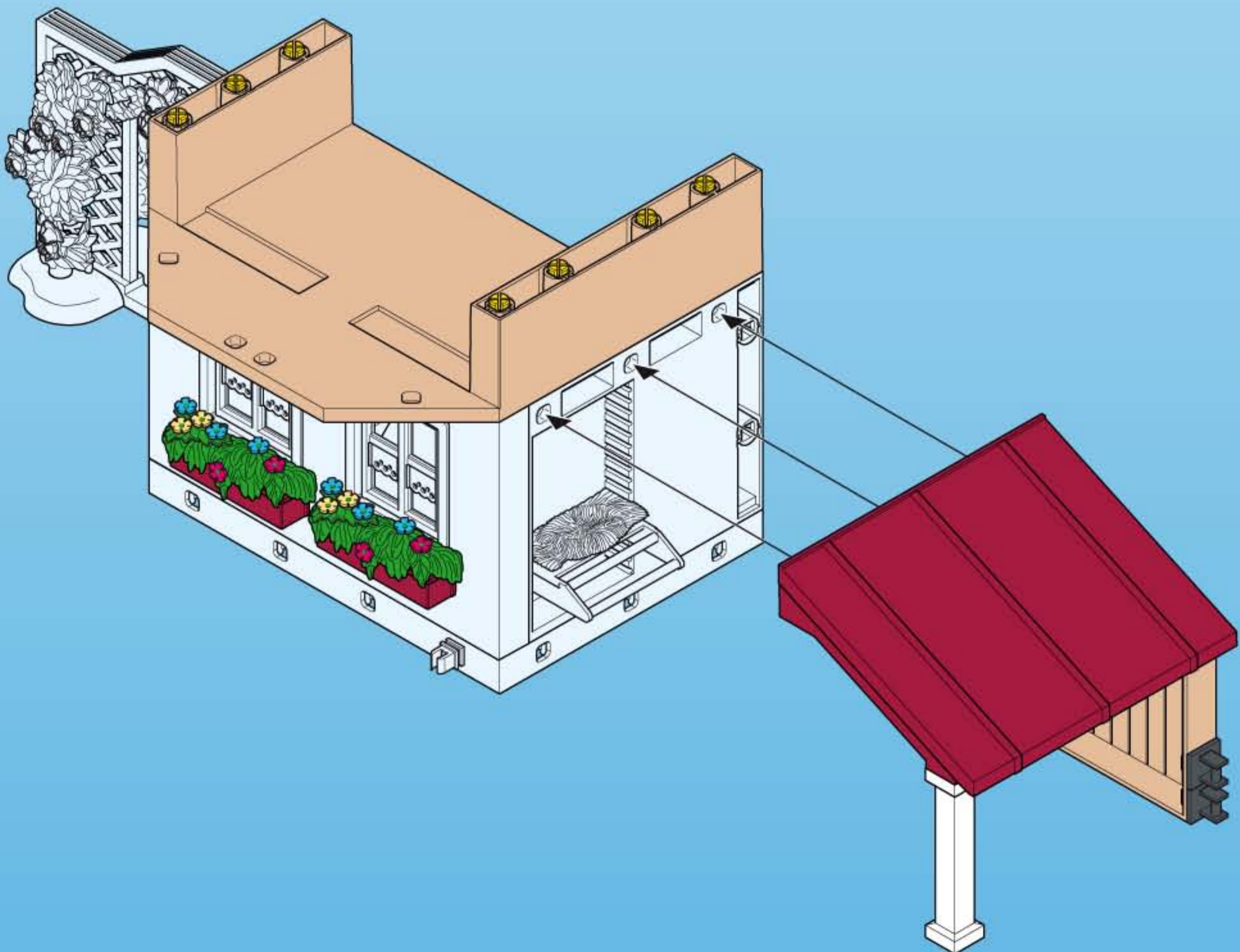
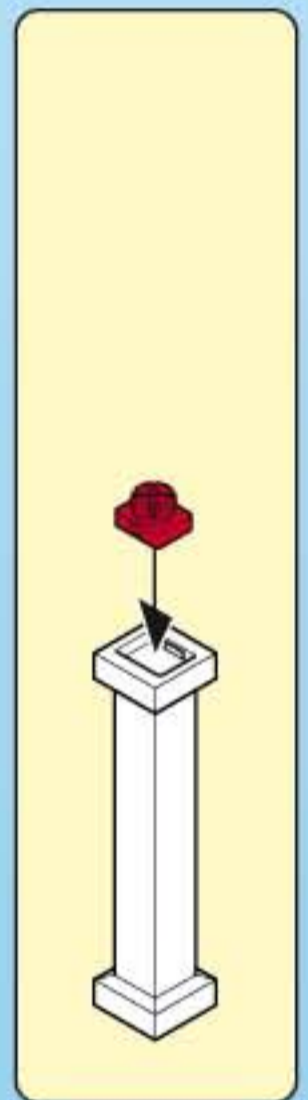
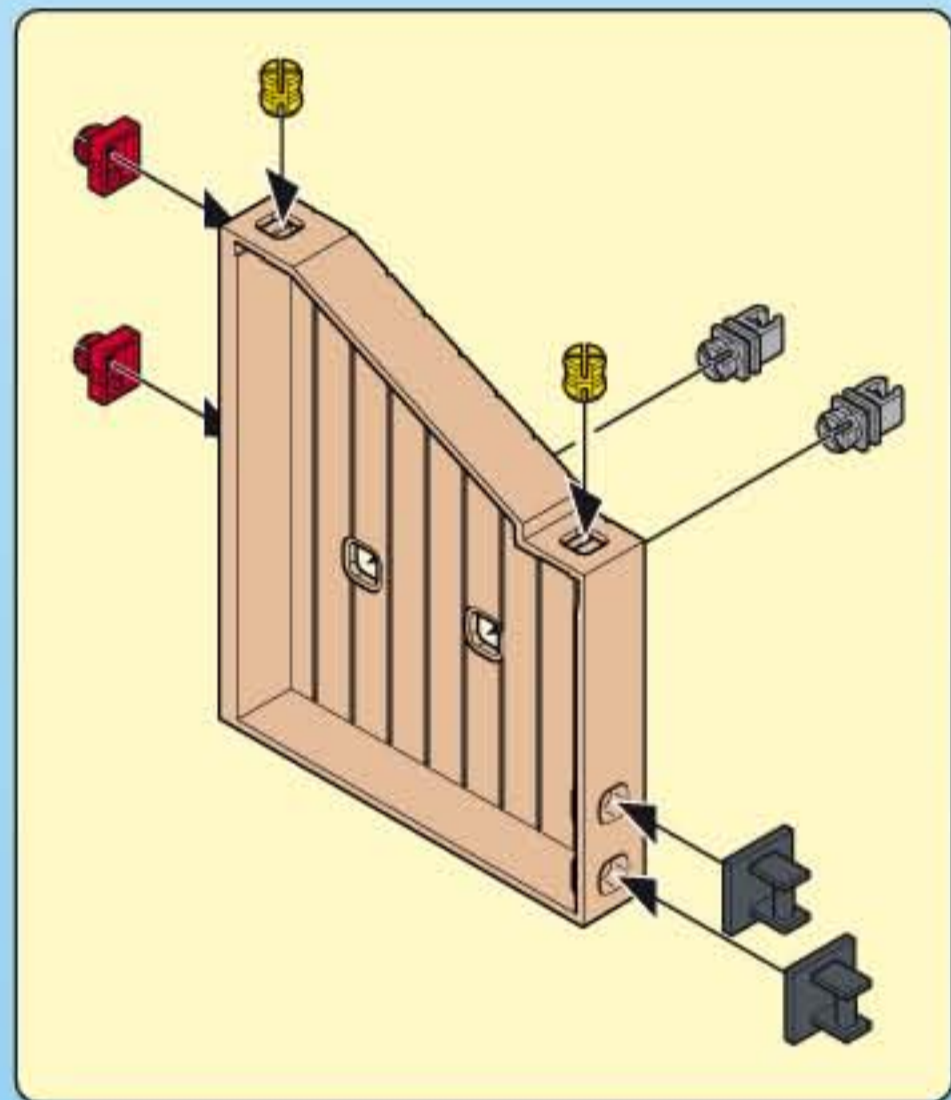
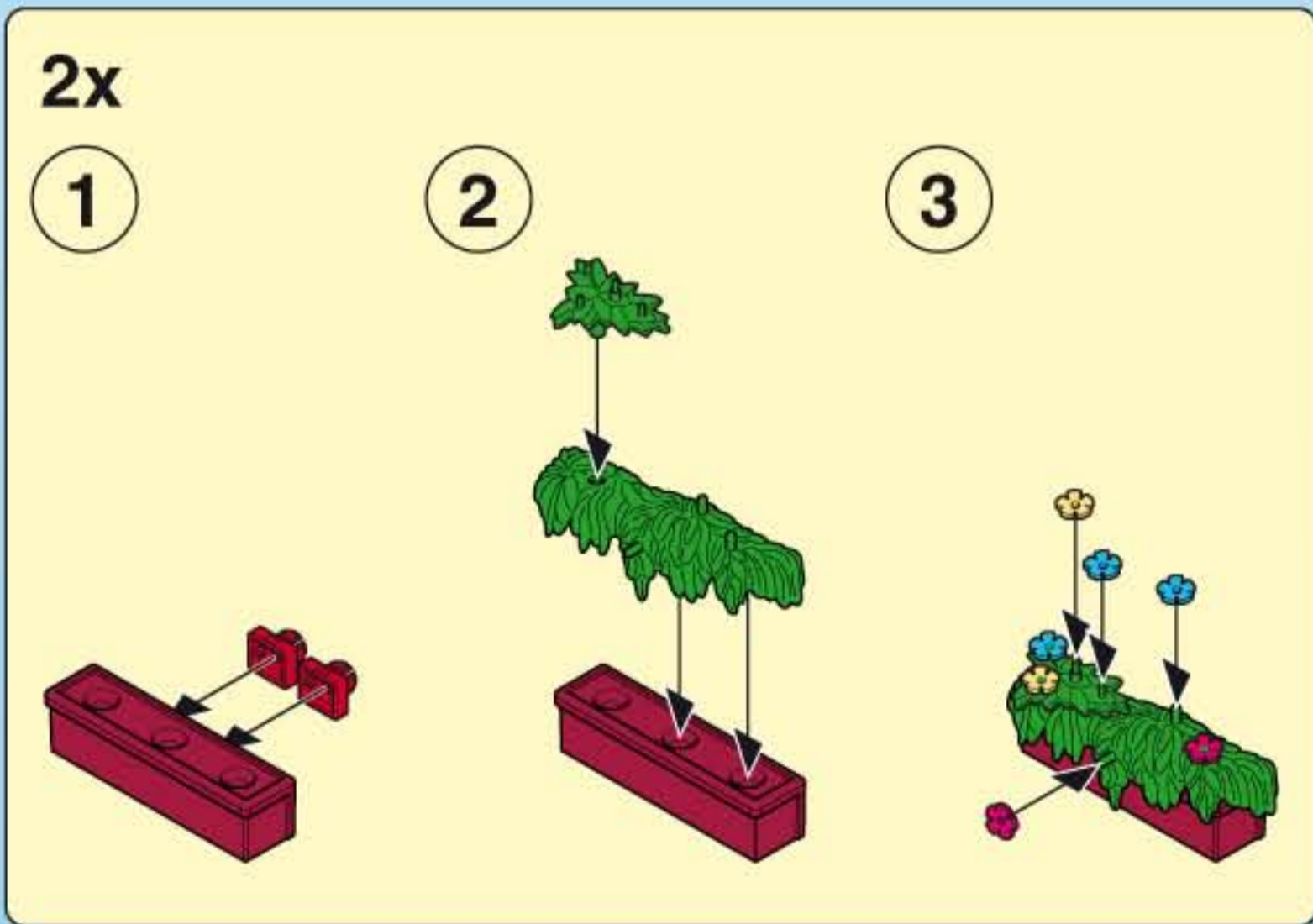
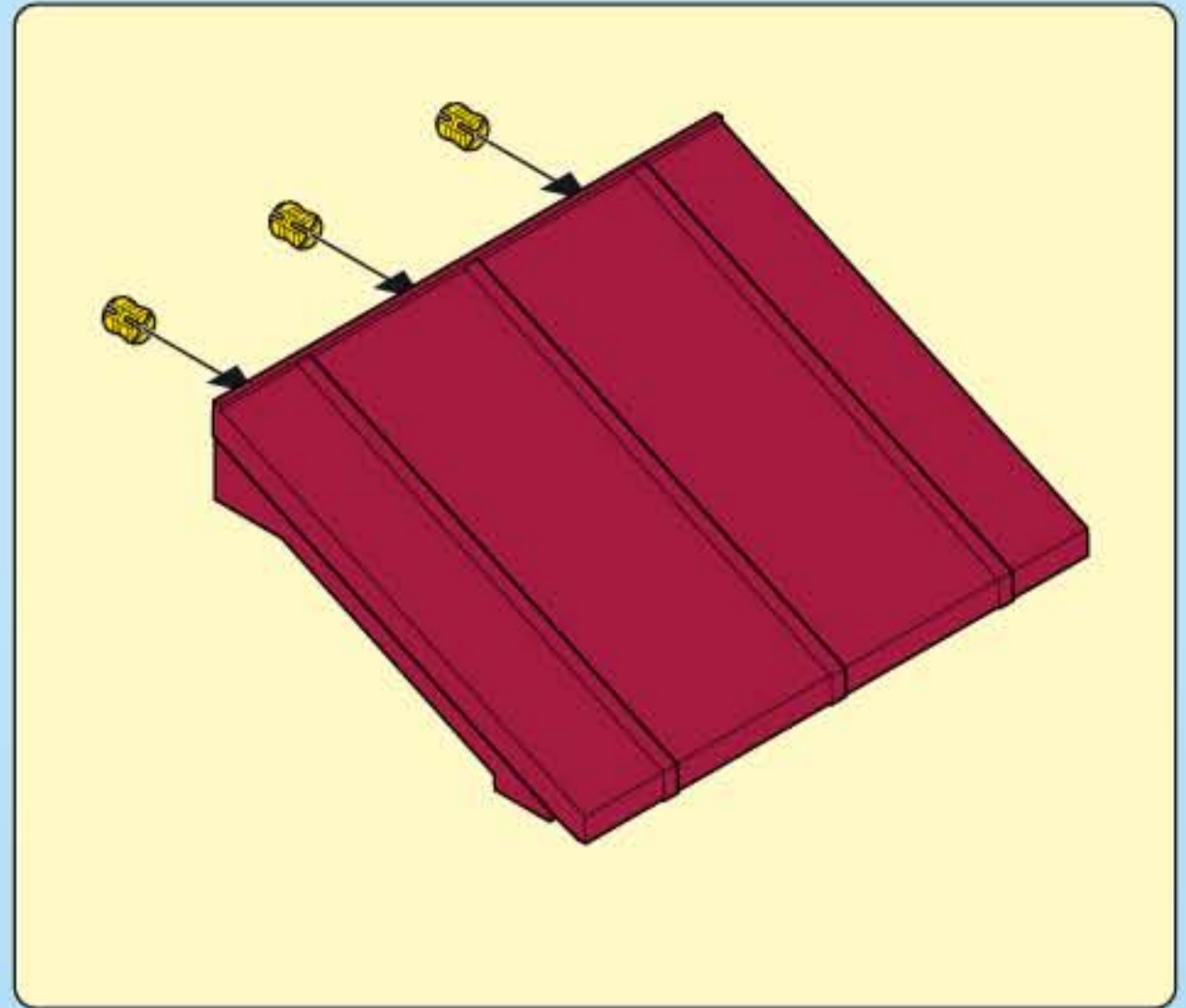
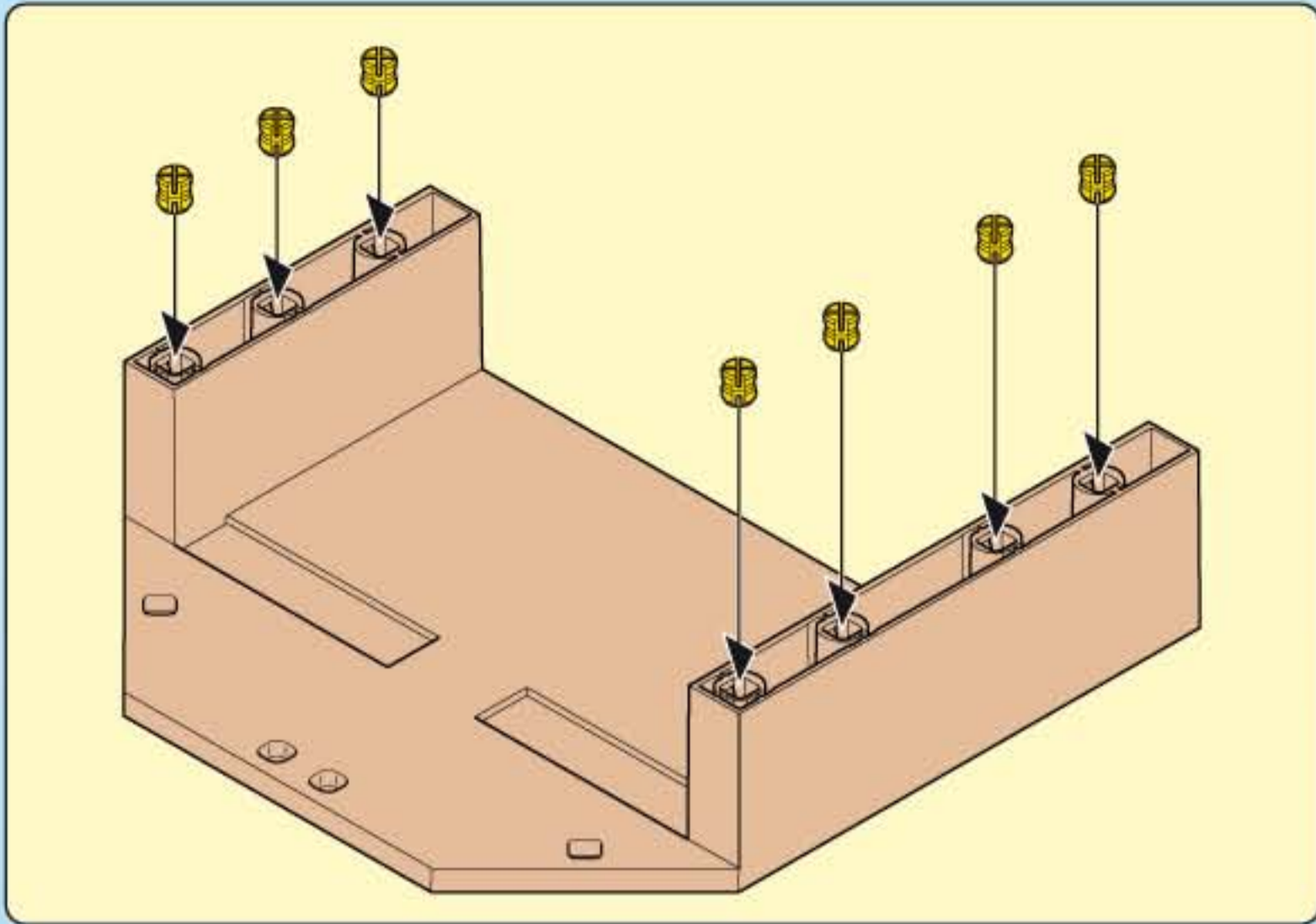

6

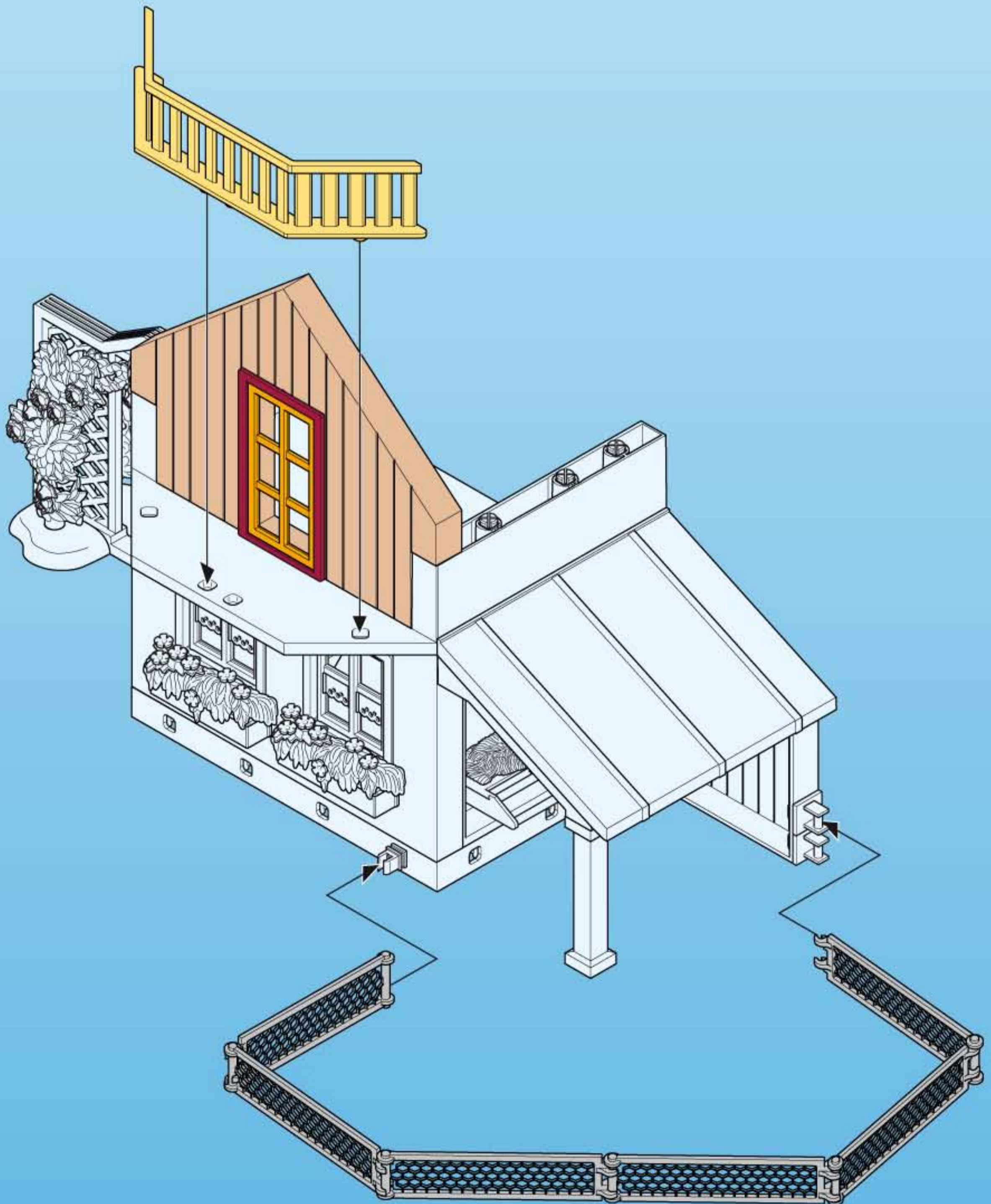
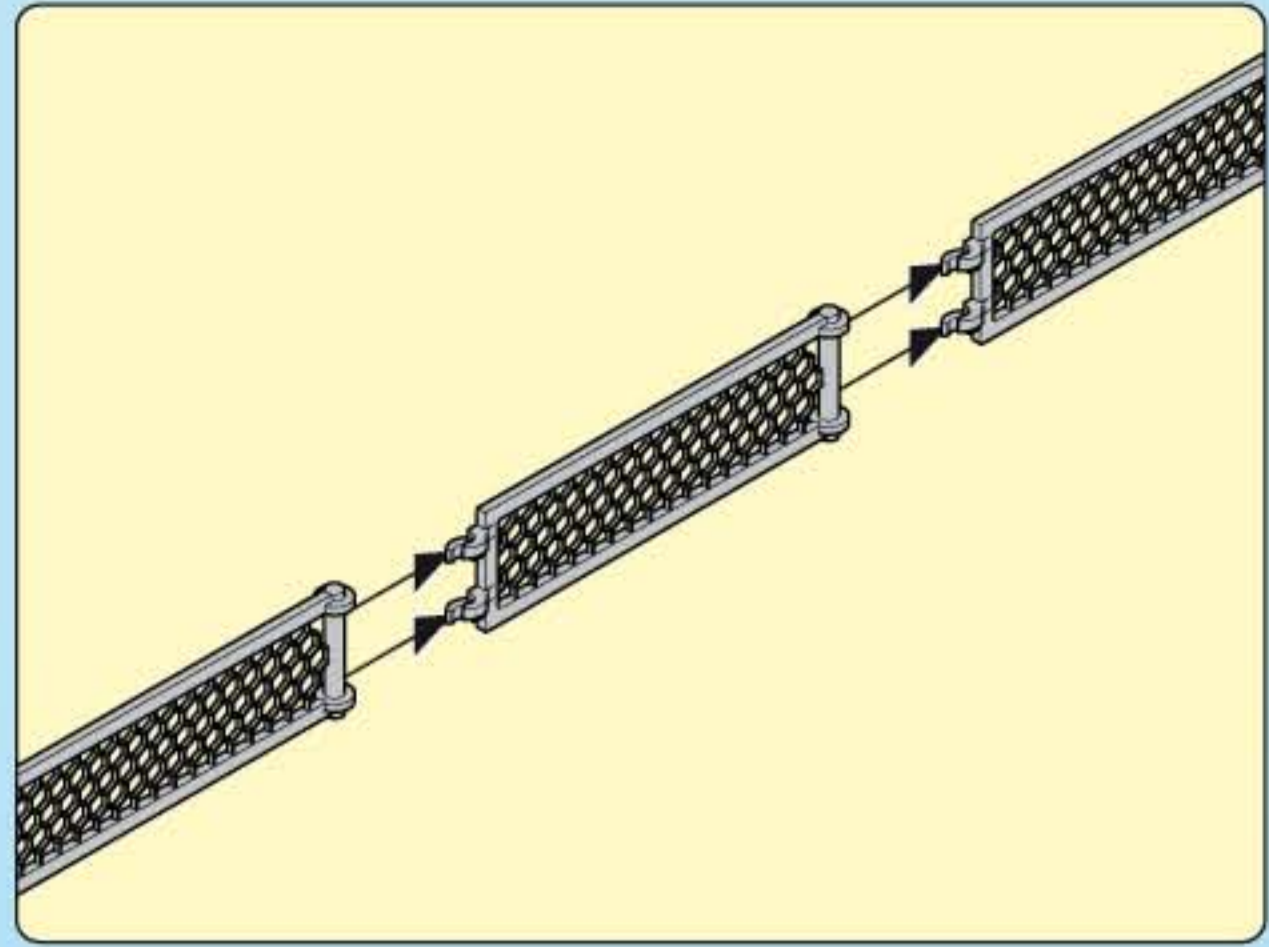
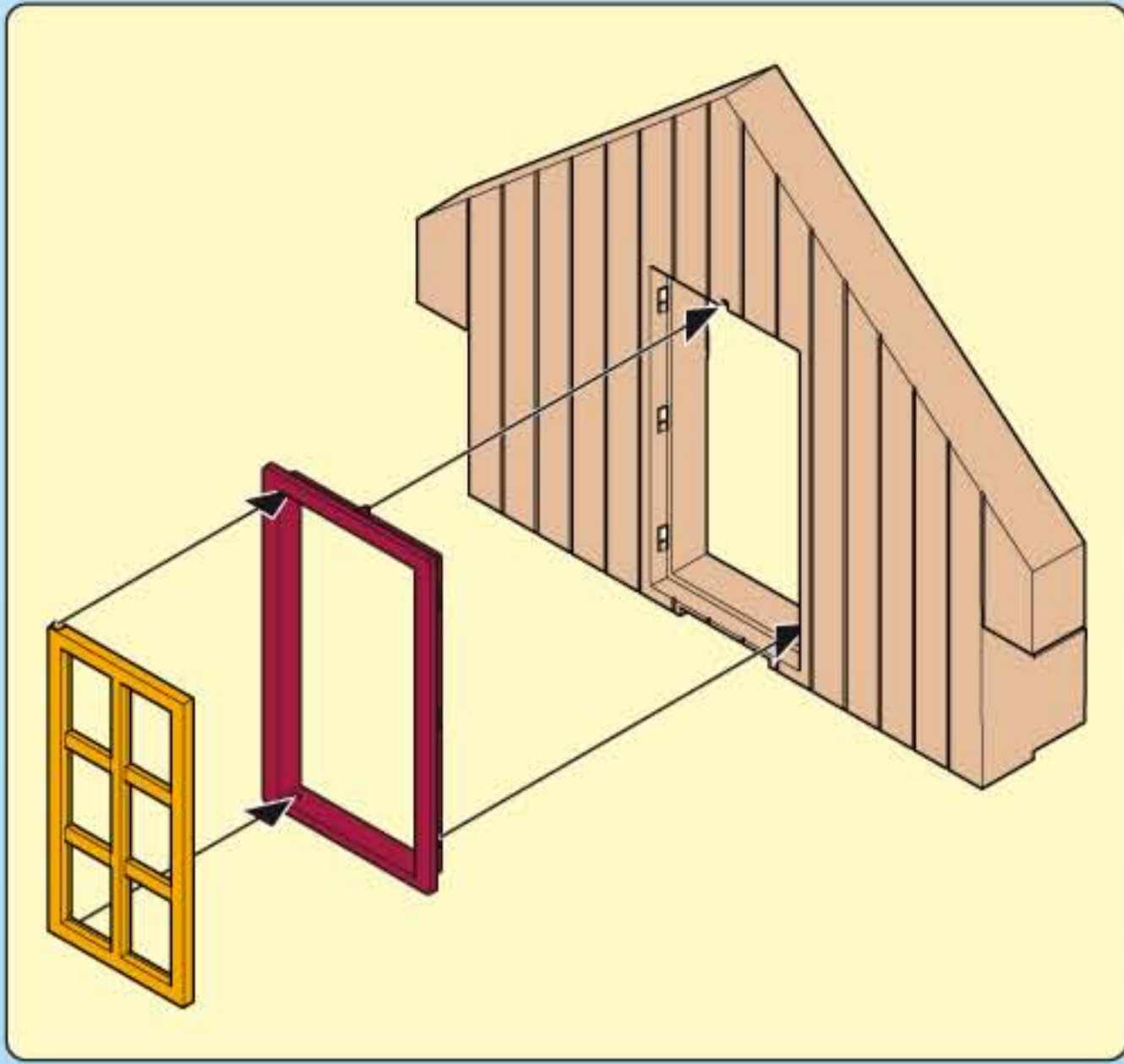

7

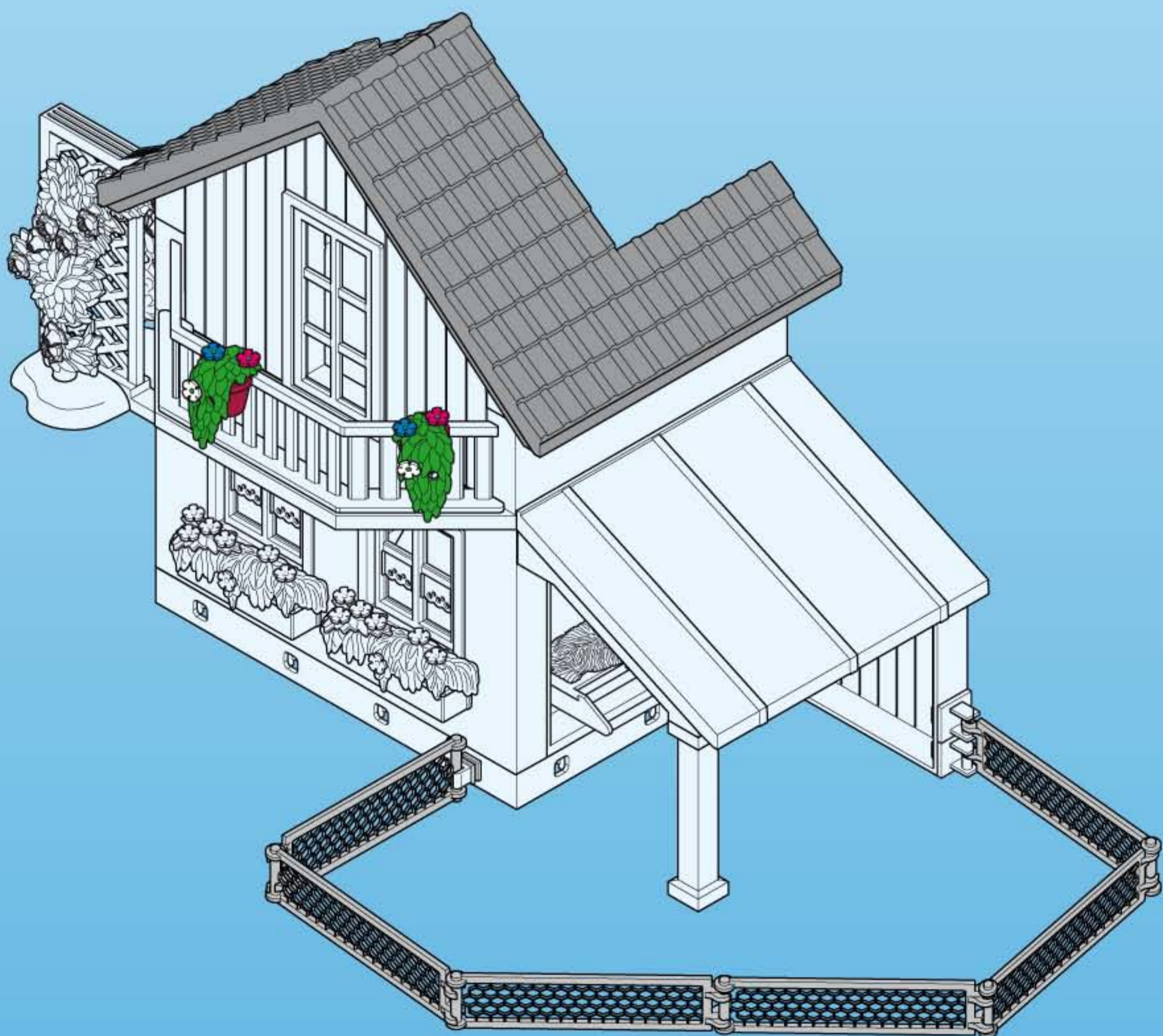
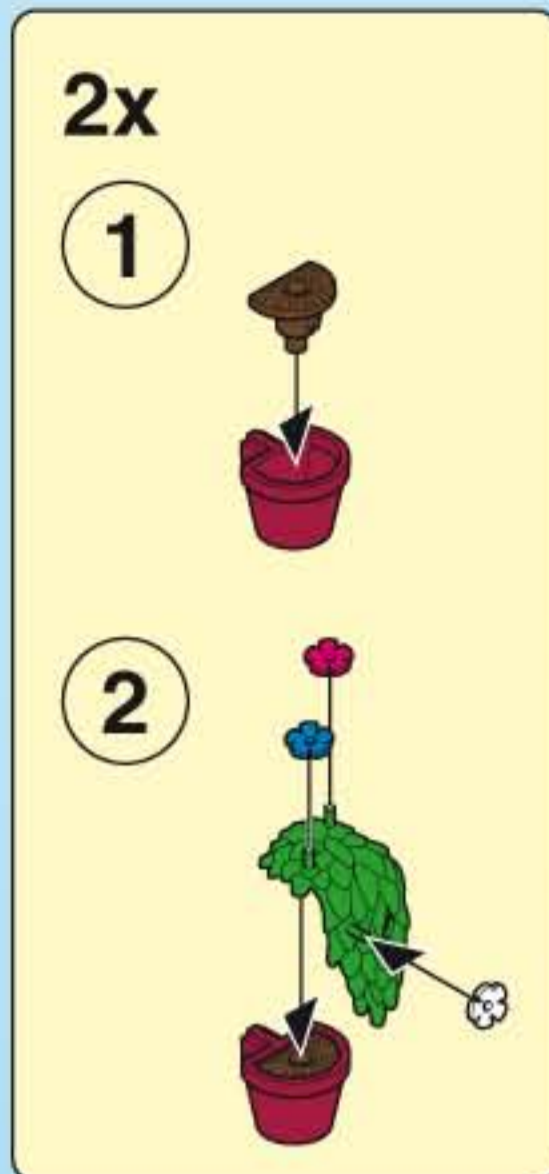
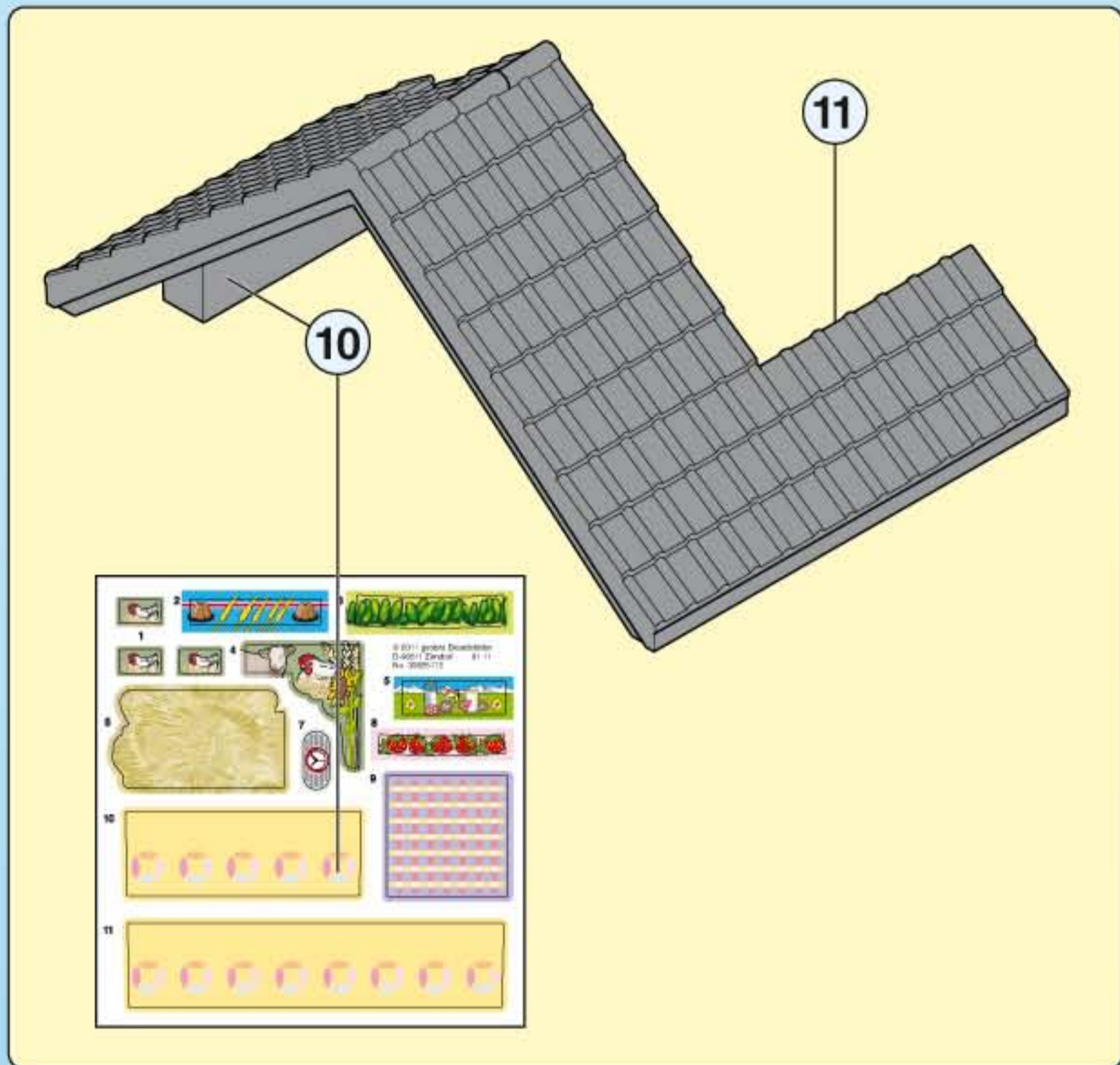

1

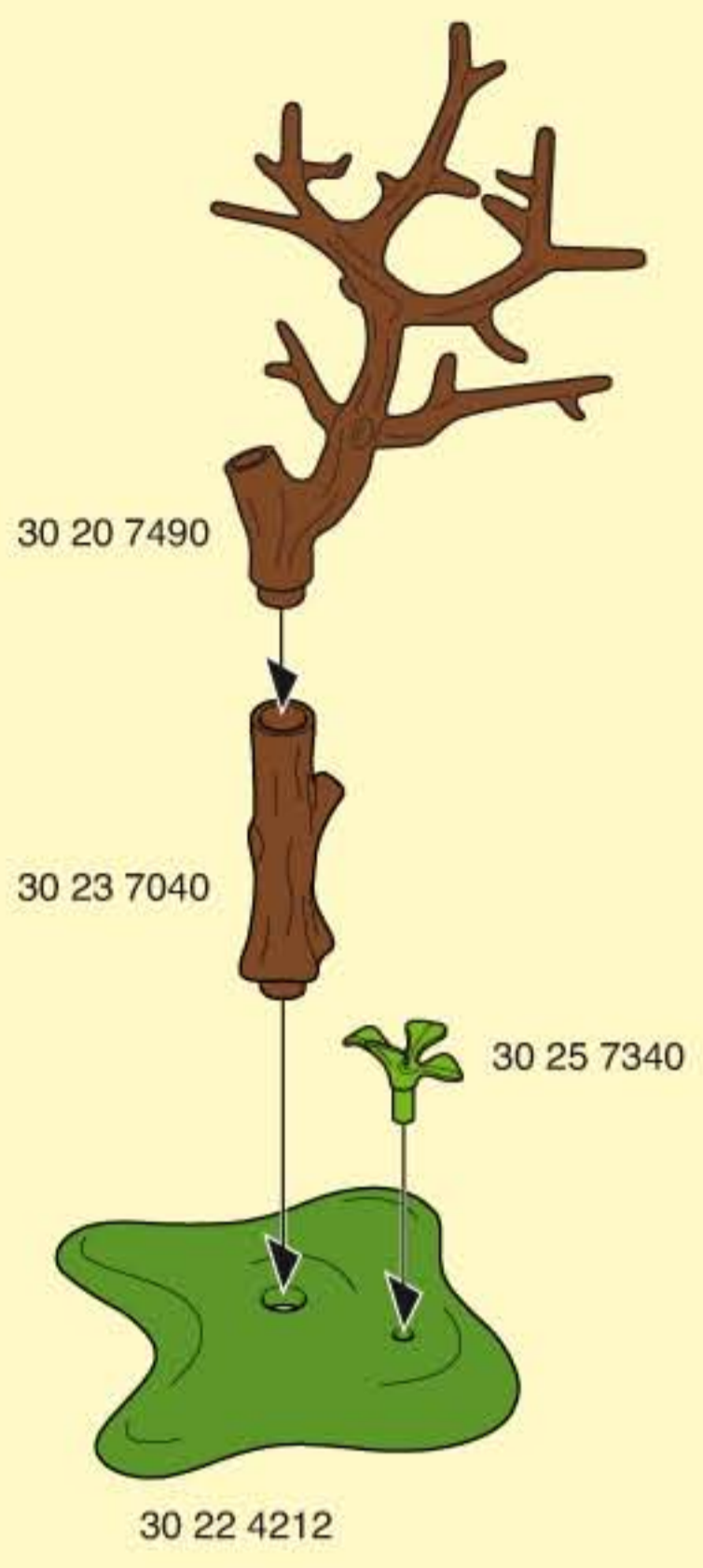

2

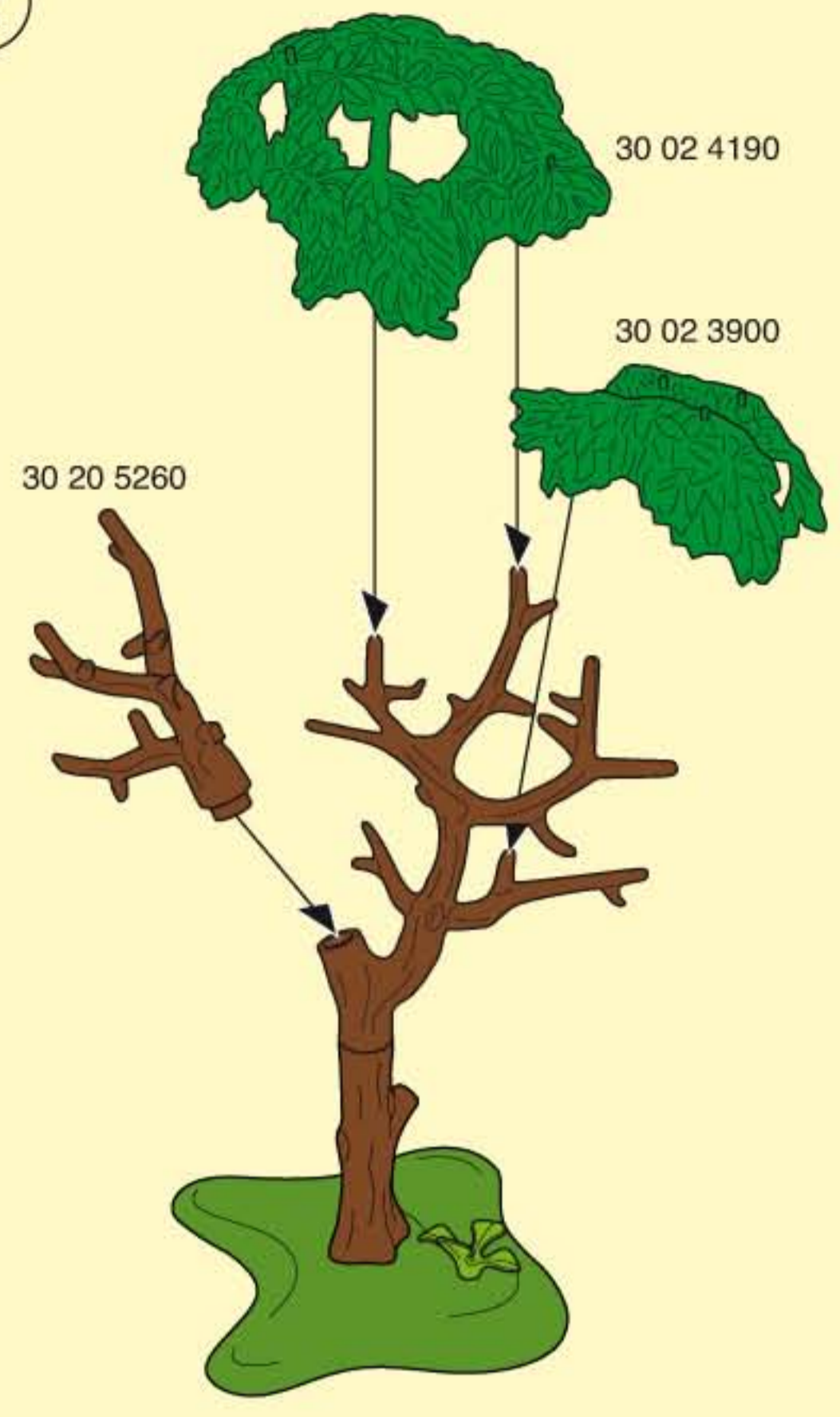

3

3x

1

30 20 6152

30 63 3042

2

30 02 3900

This inset box provides detailed instructions for adding fruit and leaves. Step 1 shows attaching a branch with fruit (30 20 6152) to a branch assembly (30 63 3042). Step 2 shows attaching a green leaf (30 02 3900) to the branch assembly.

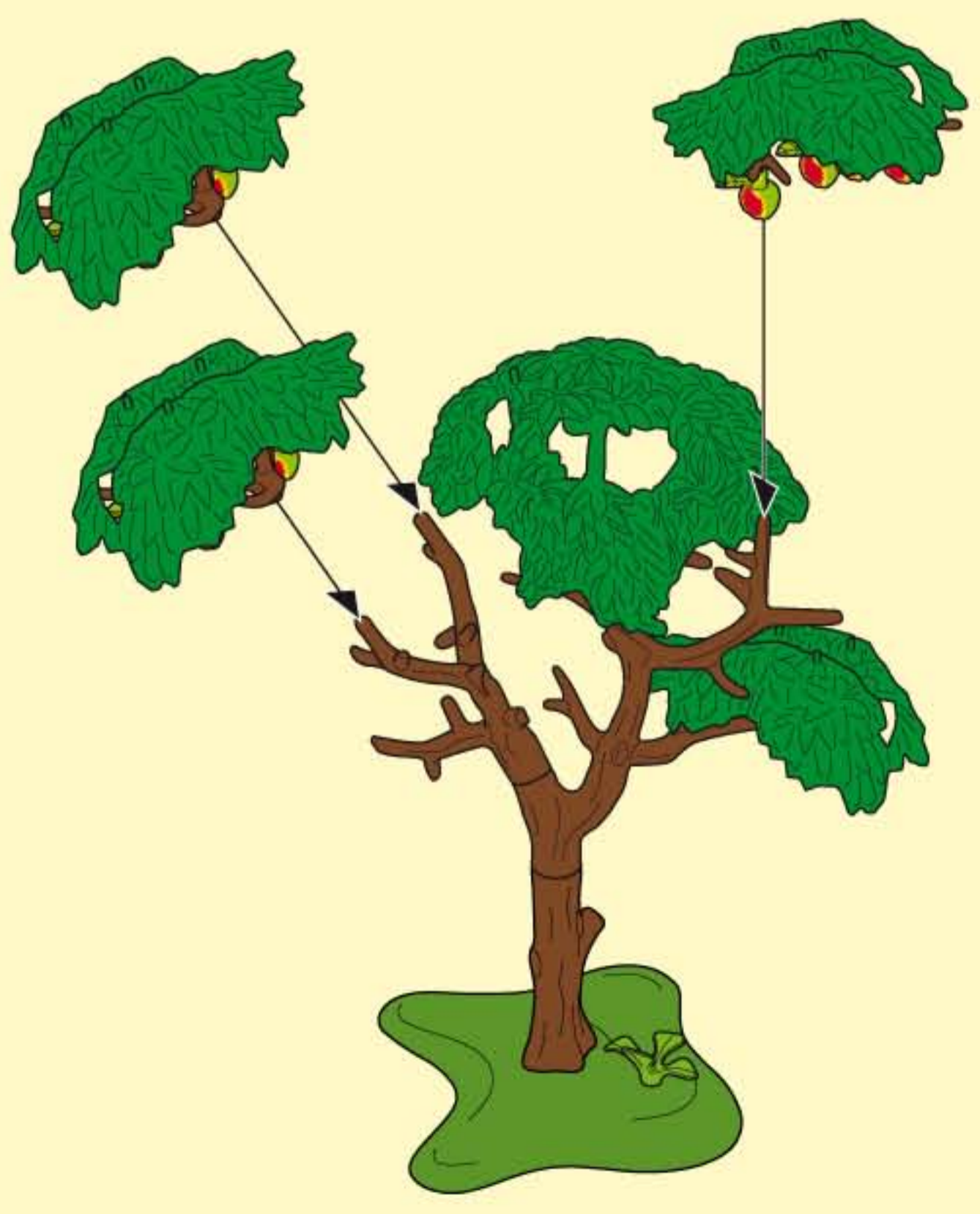

1

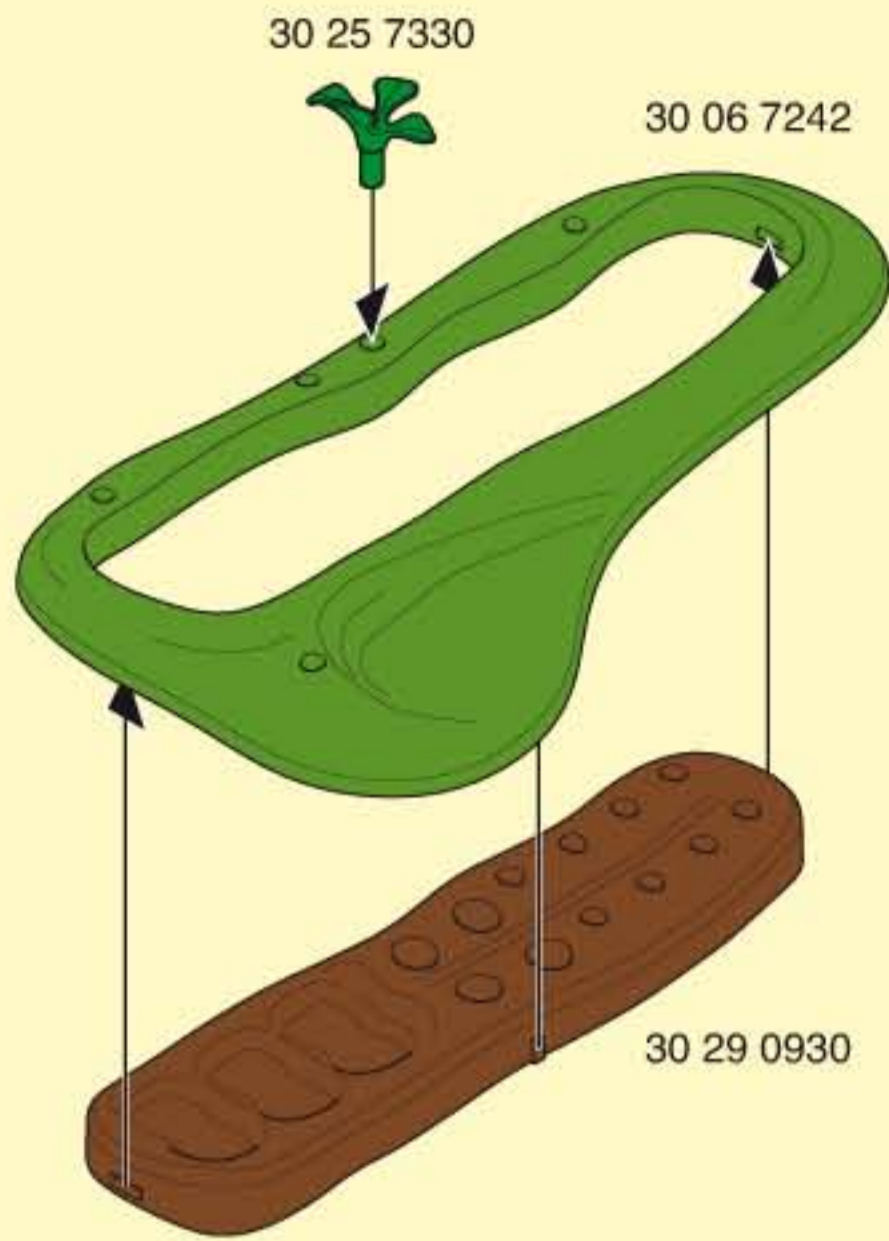

2

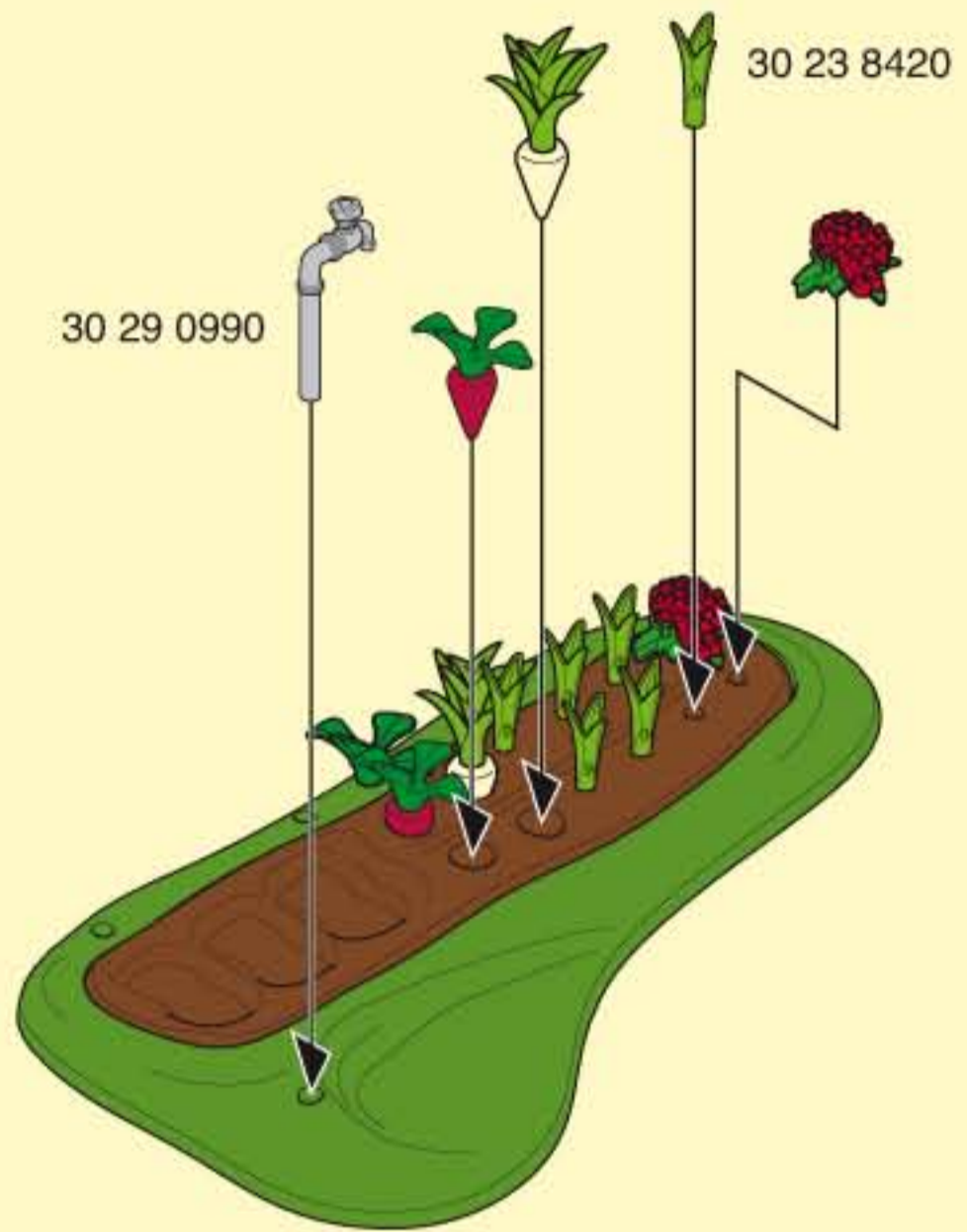
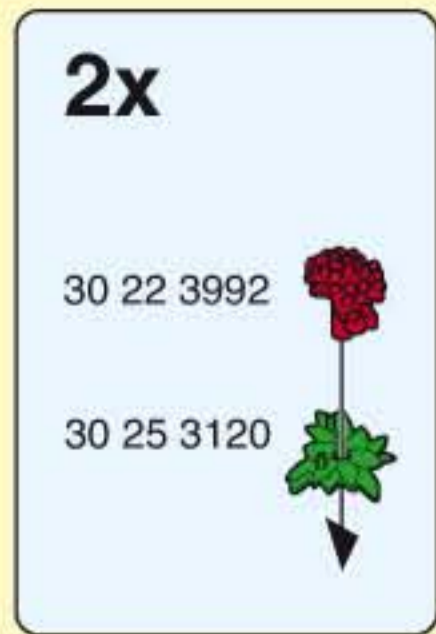
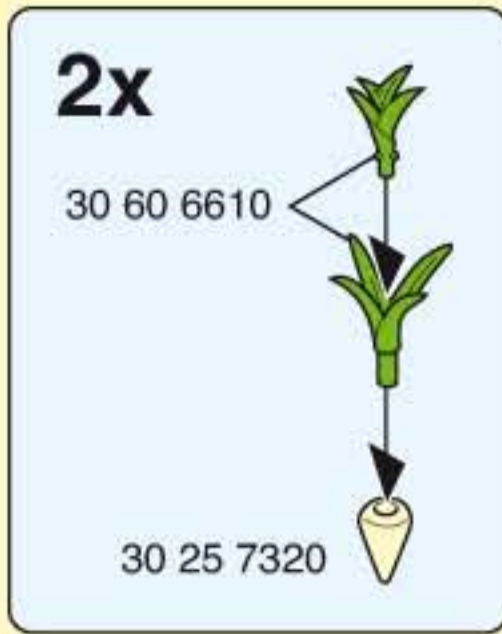
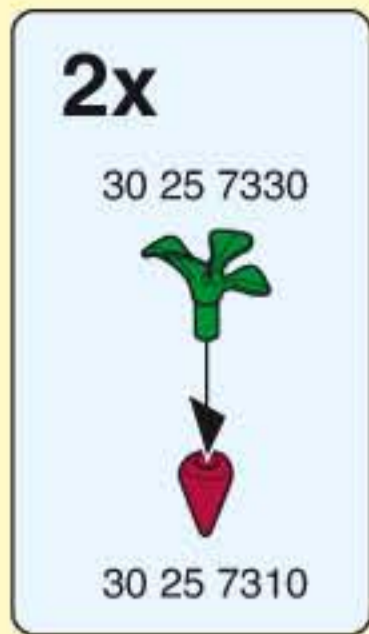

3

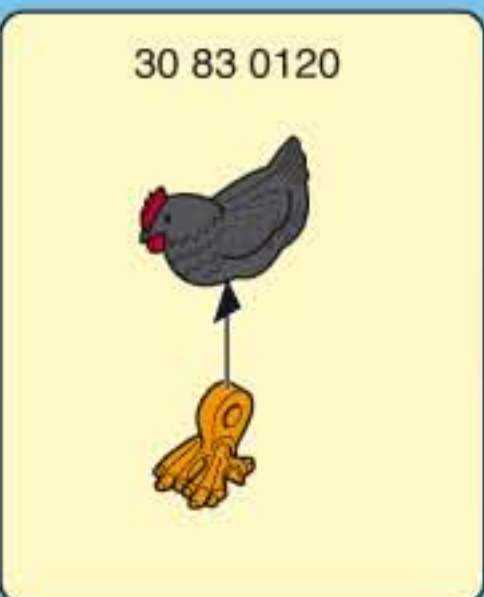
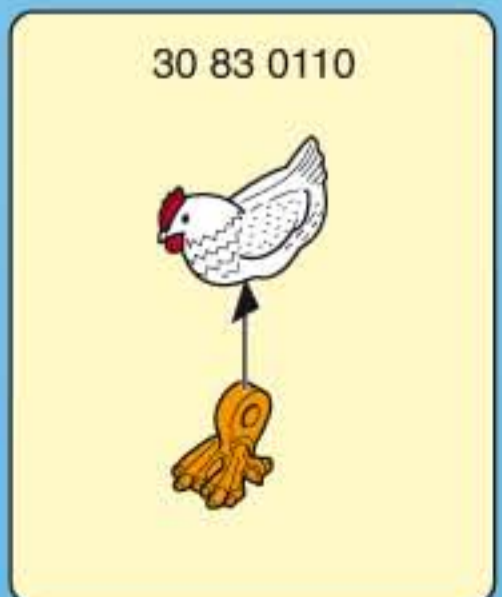
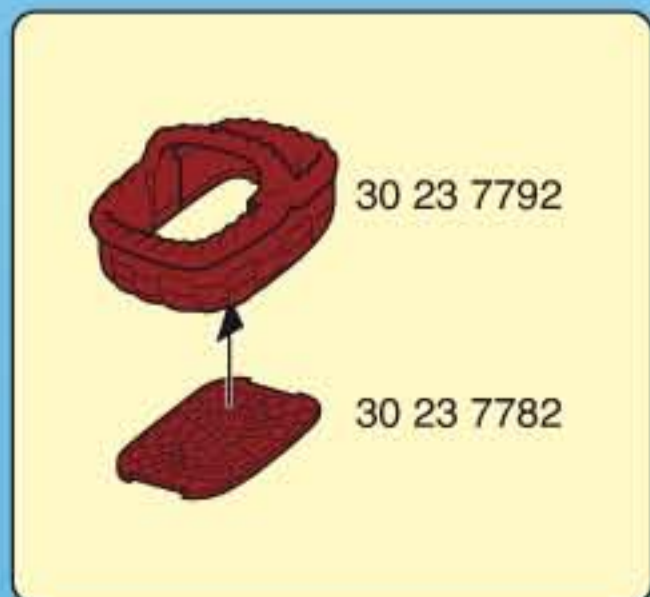
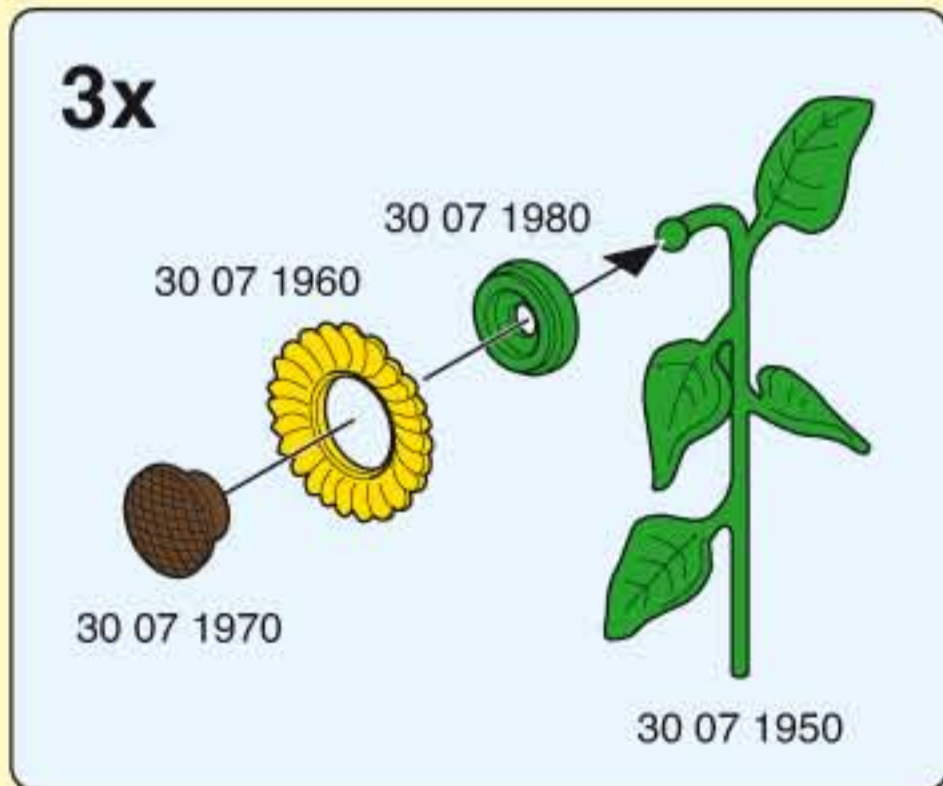

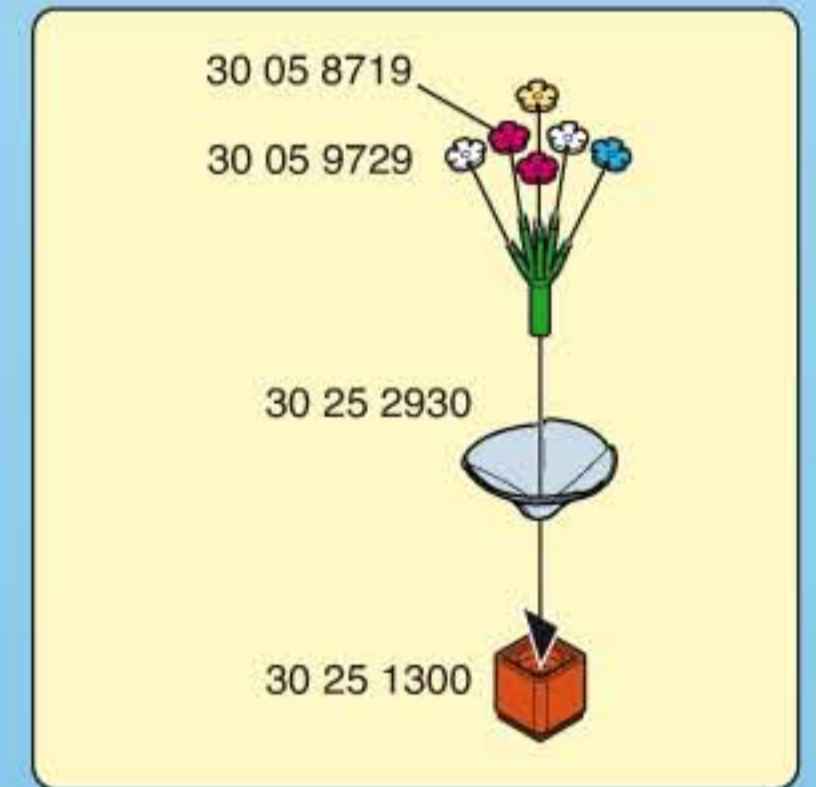
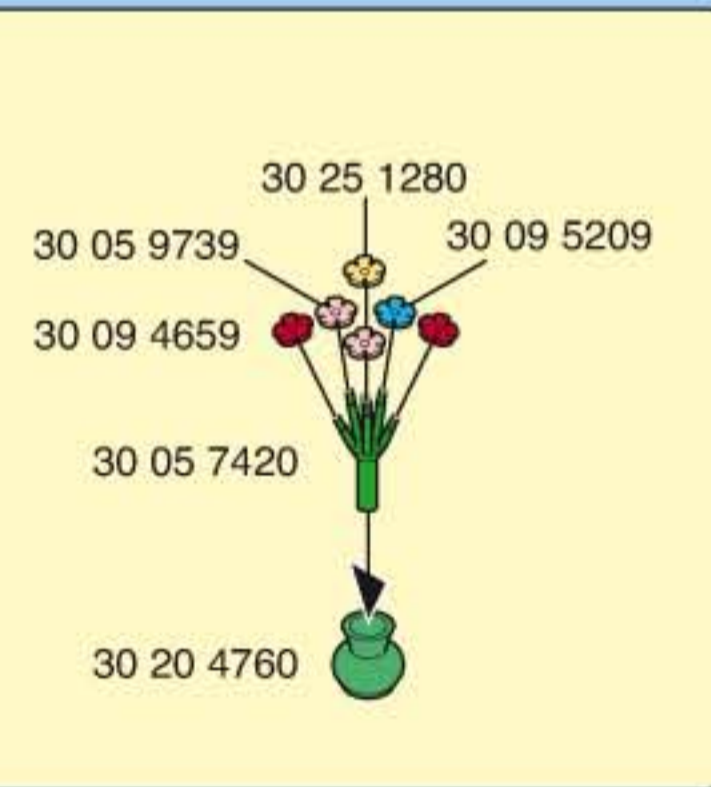
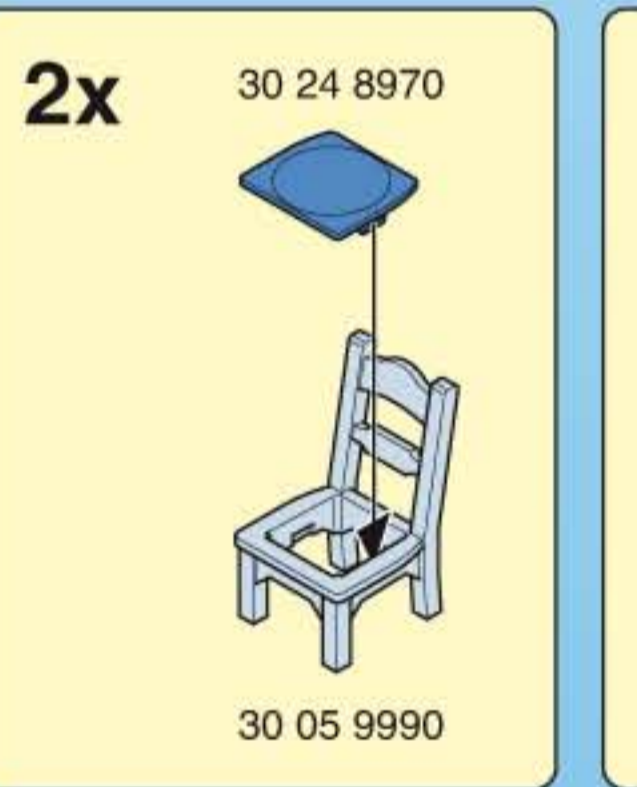
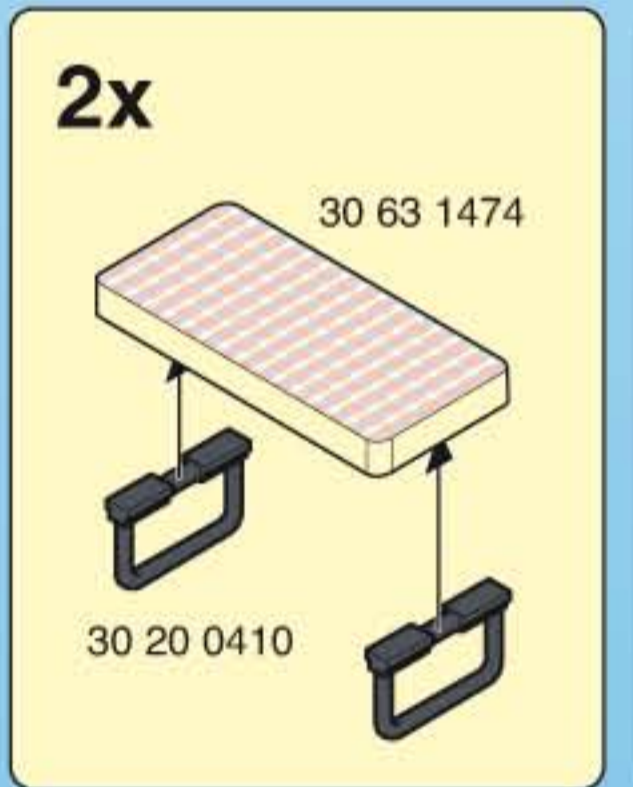
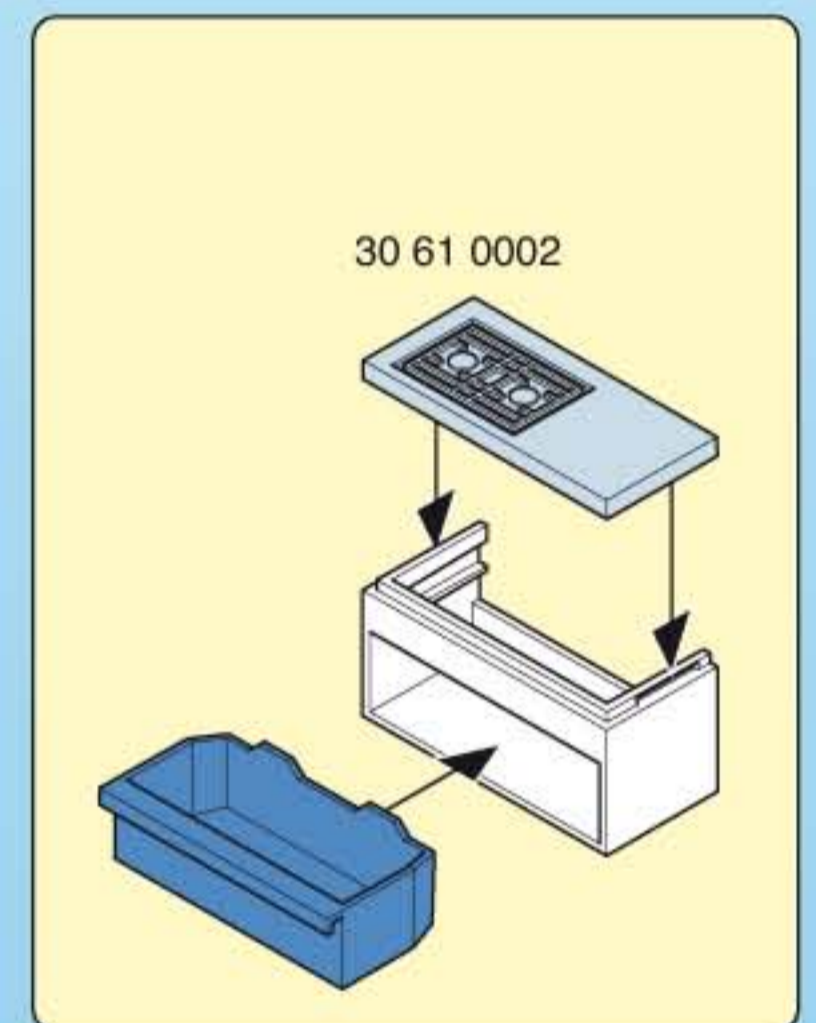
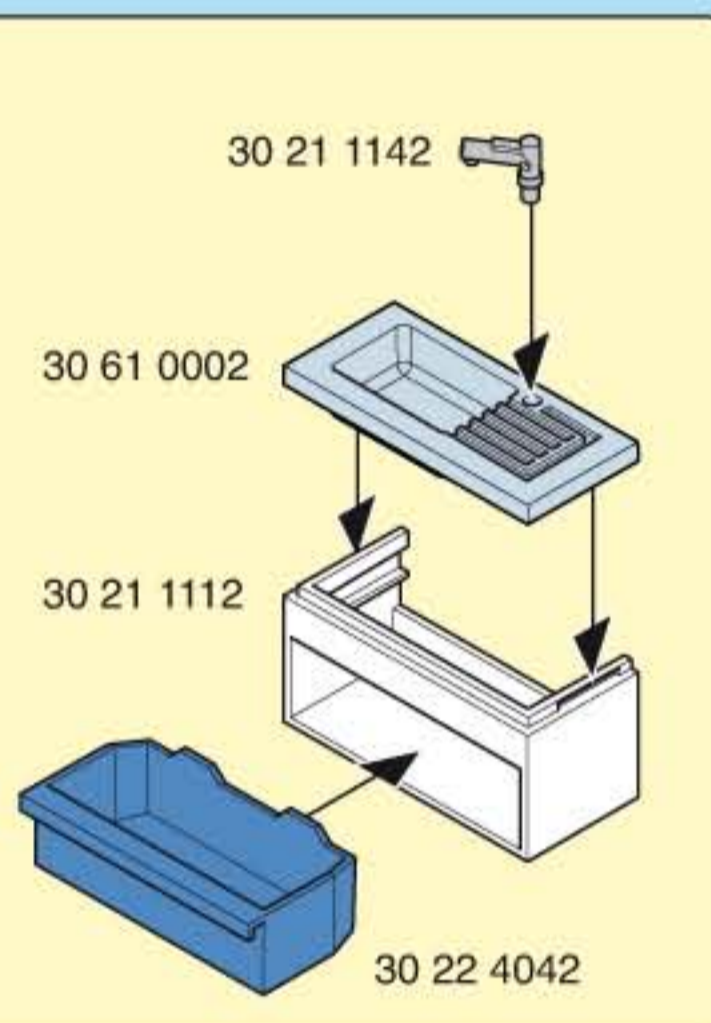
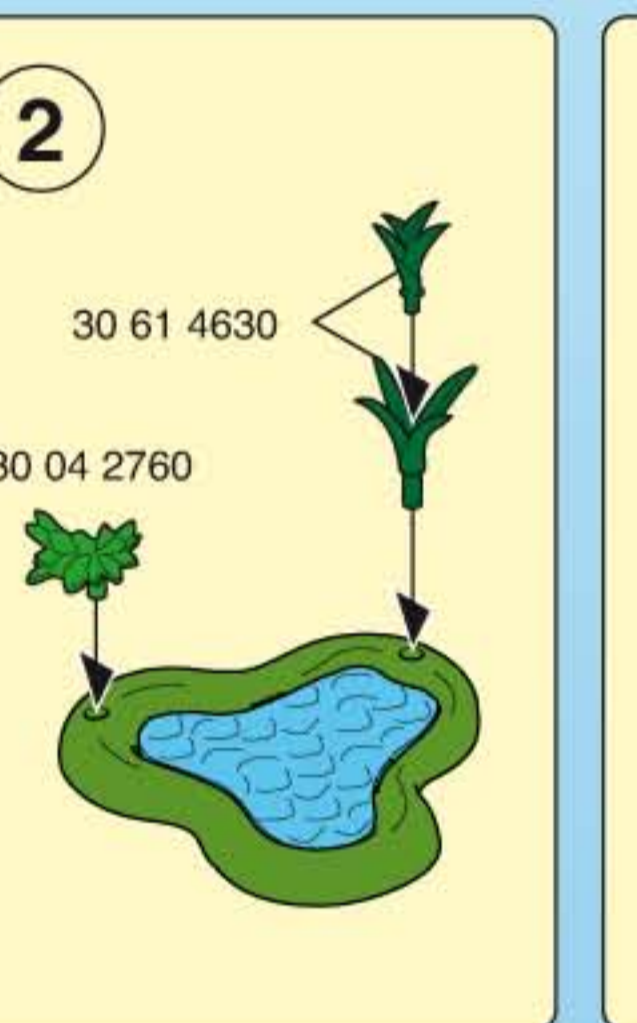
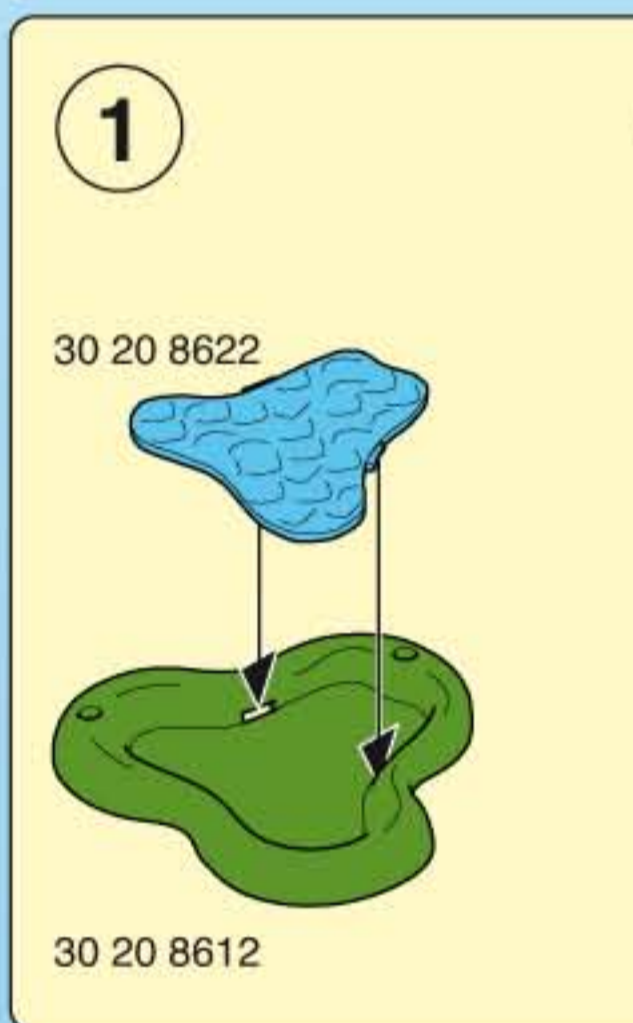
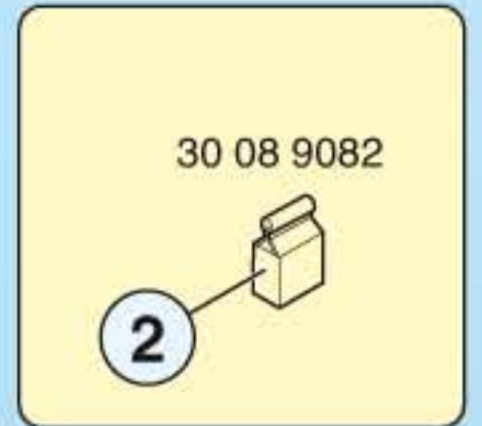
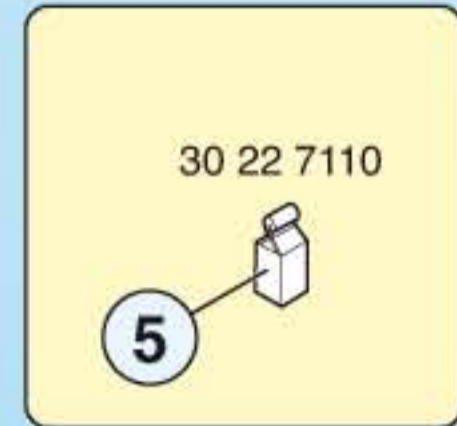
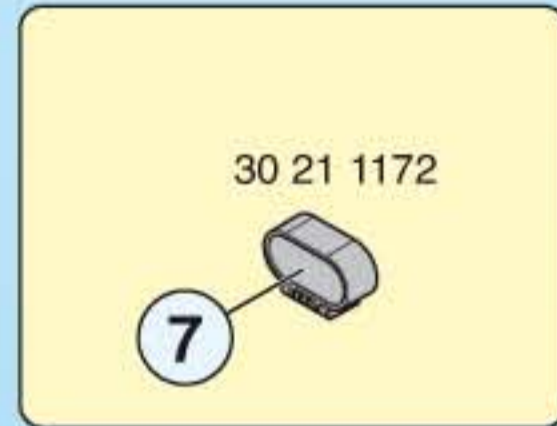
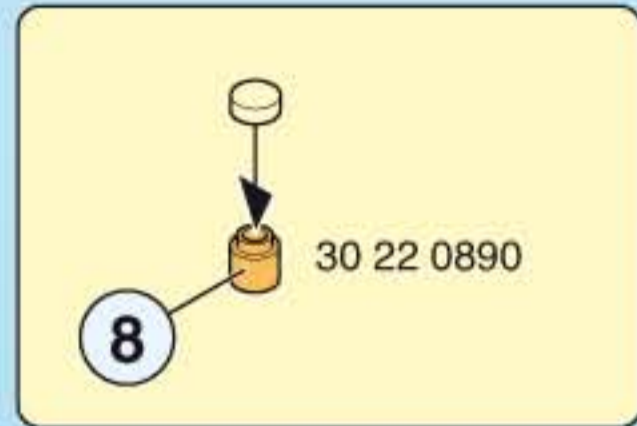
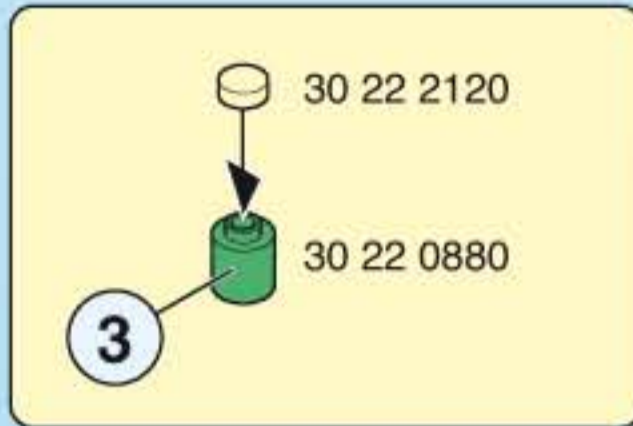
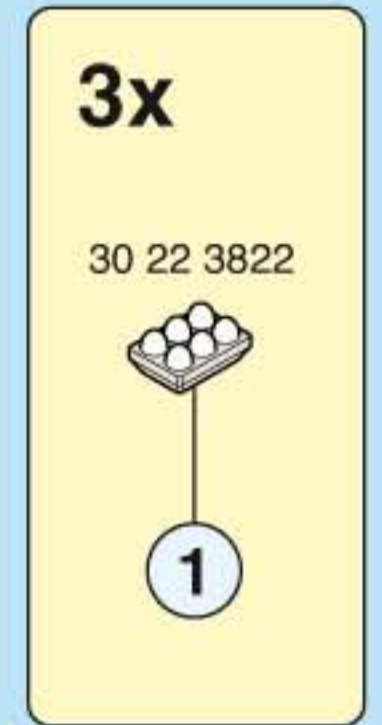
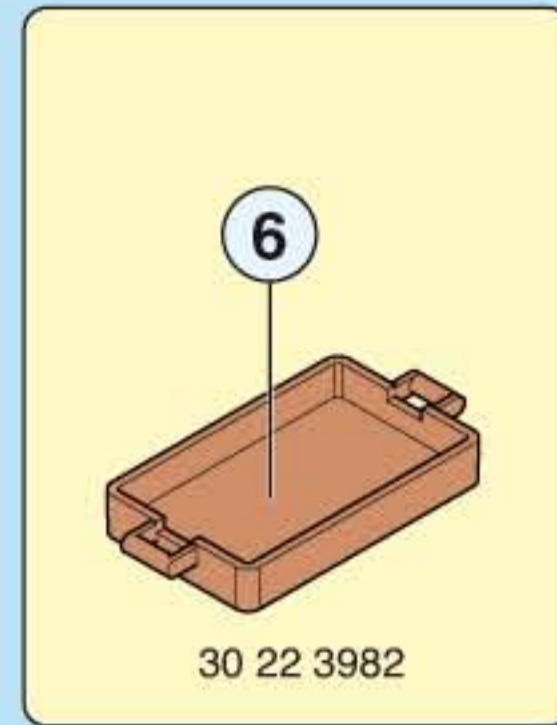
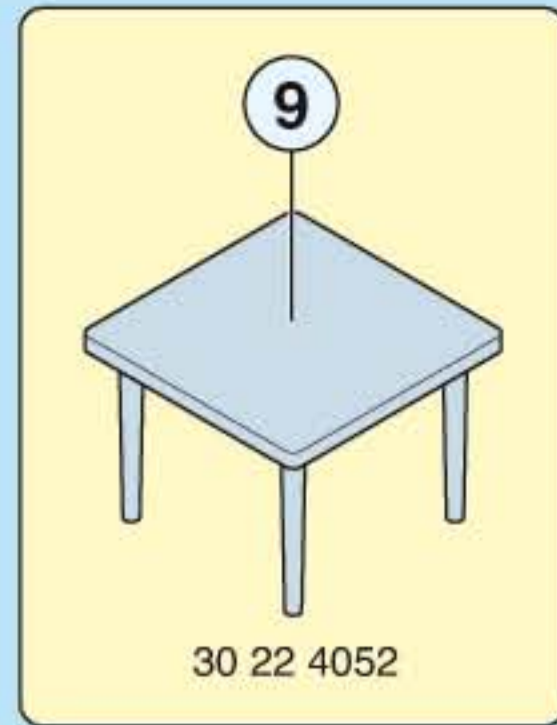
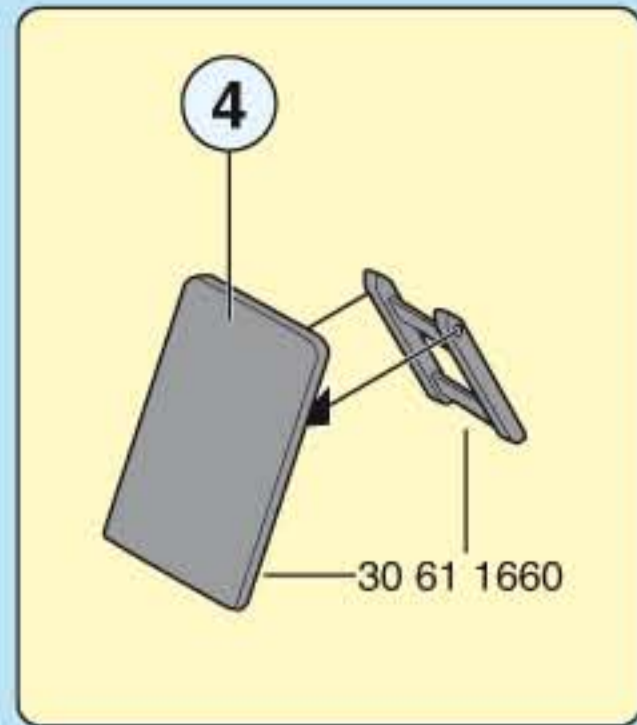

30 00 9002



30 14 5010

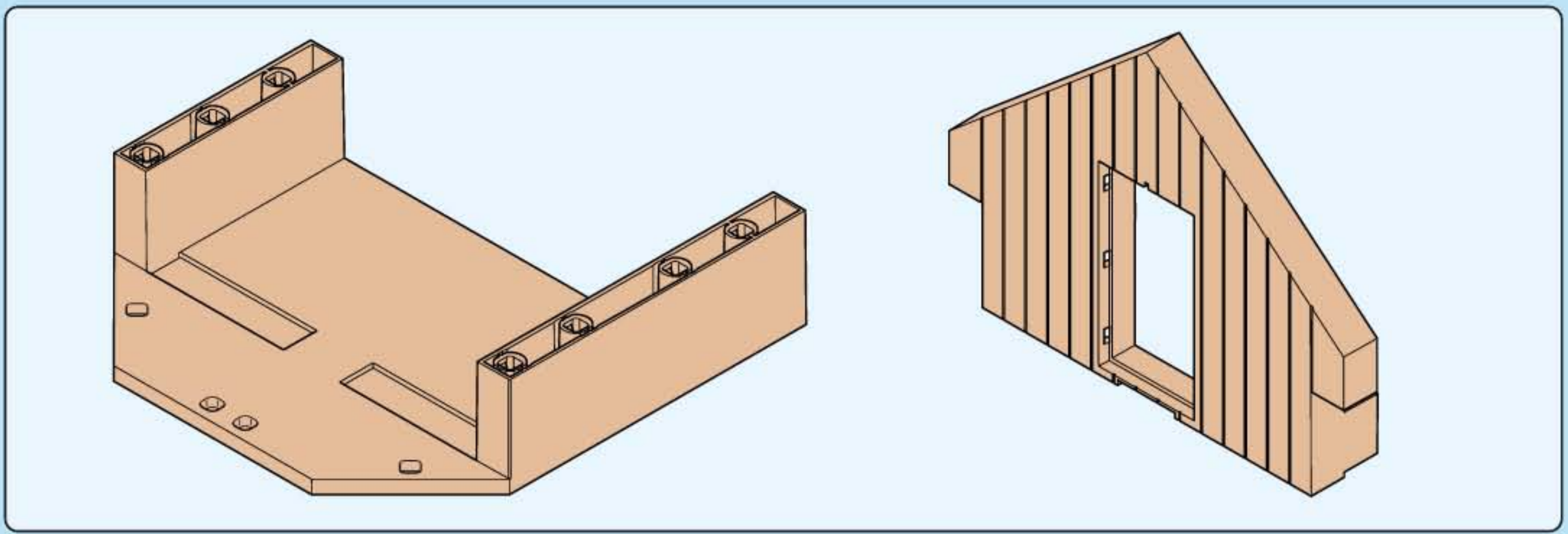

30 51 9120

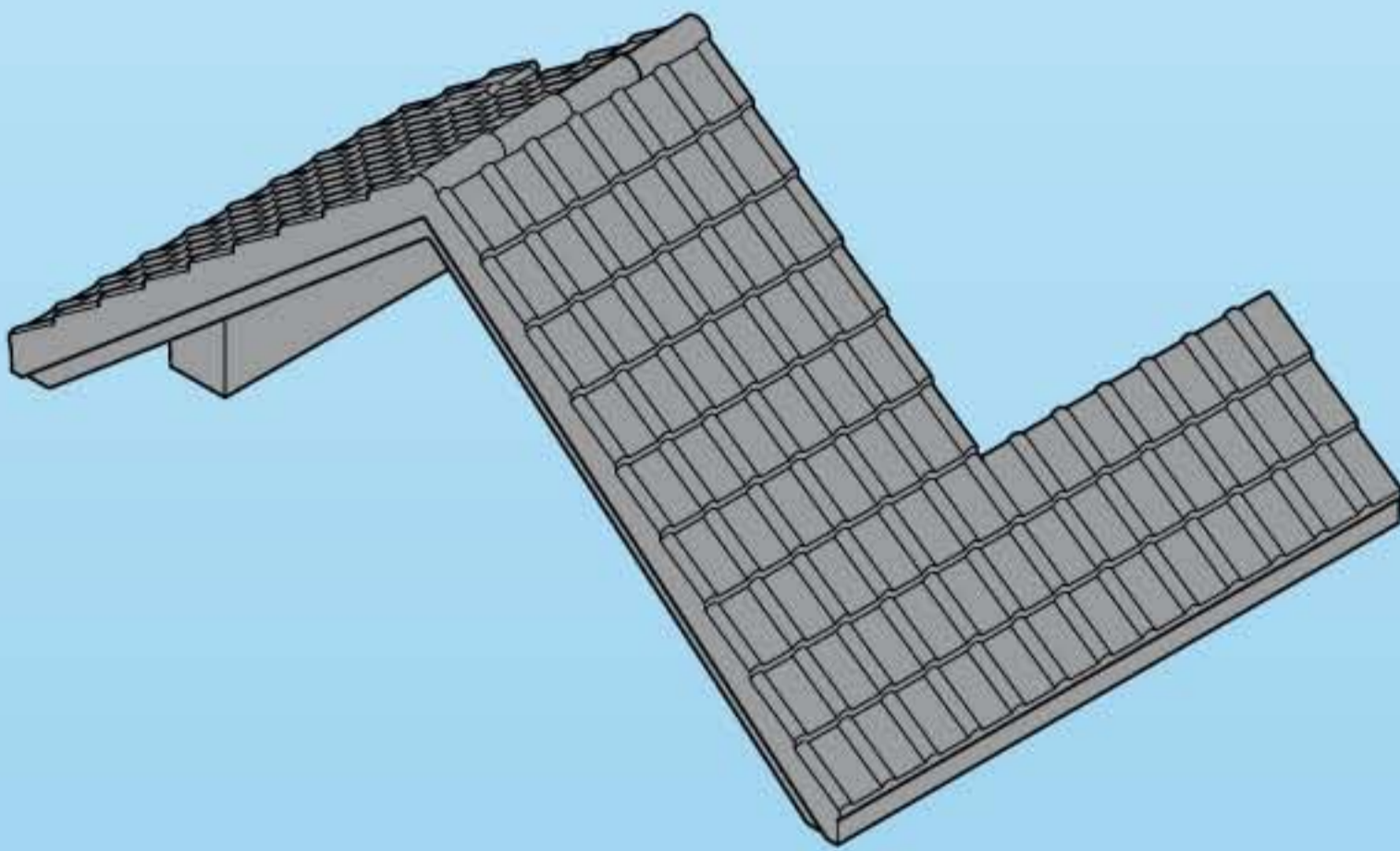

30 22 3902

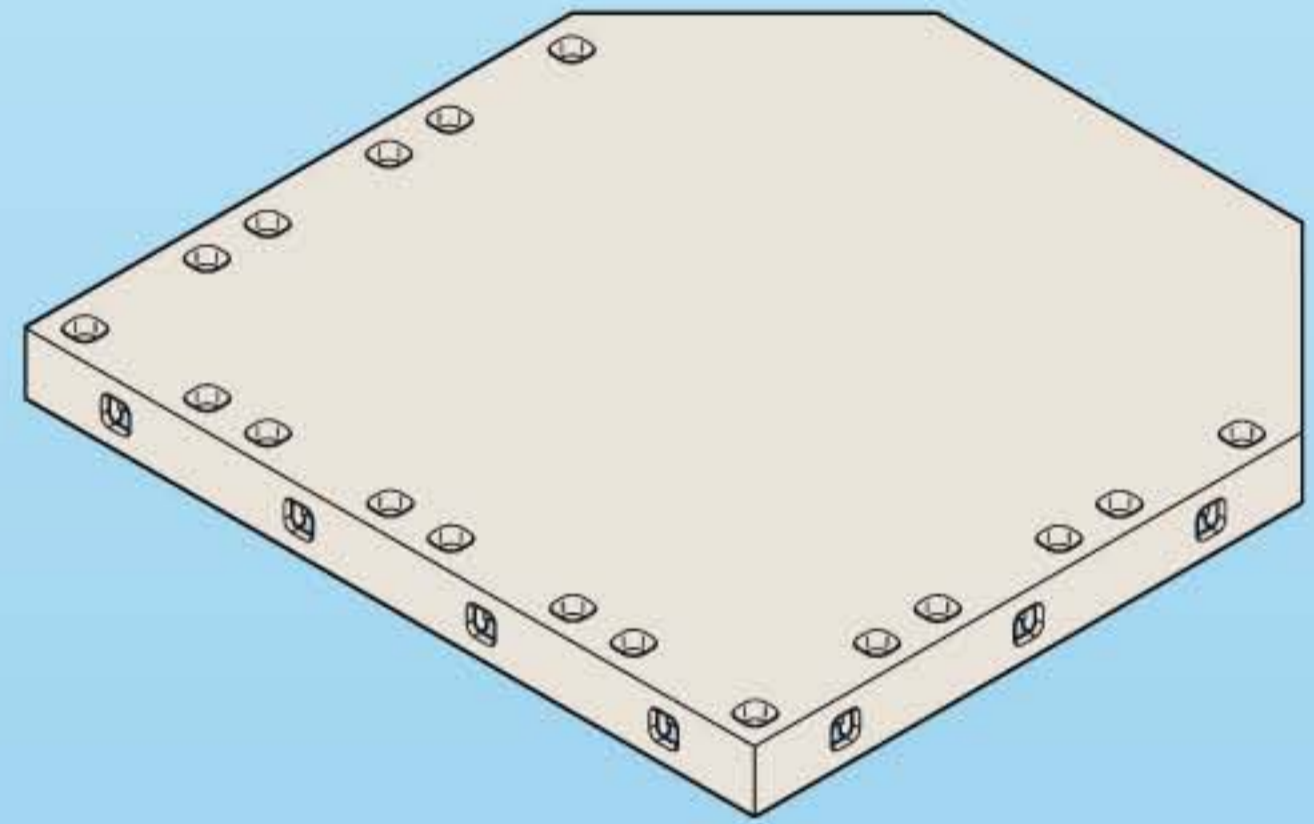

30 22 3882

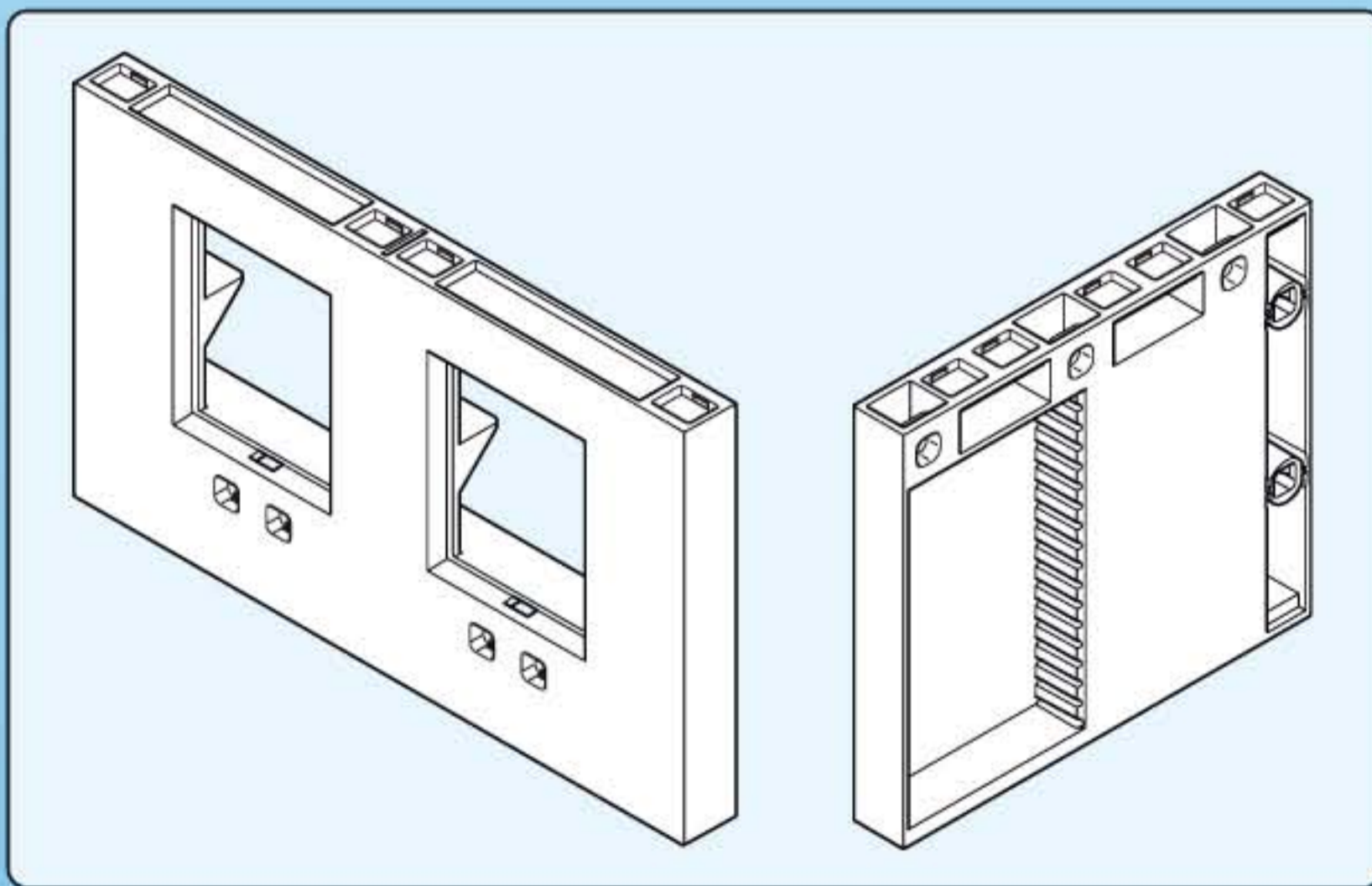

30 51 9130

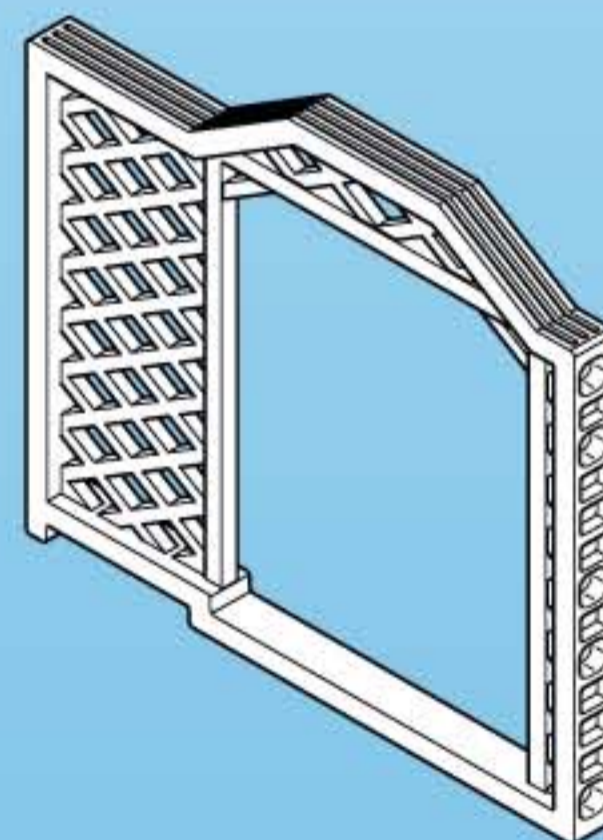

30 22 3852

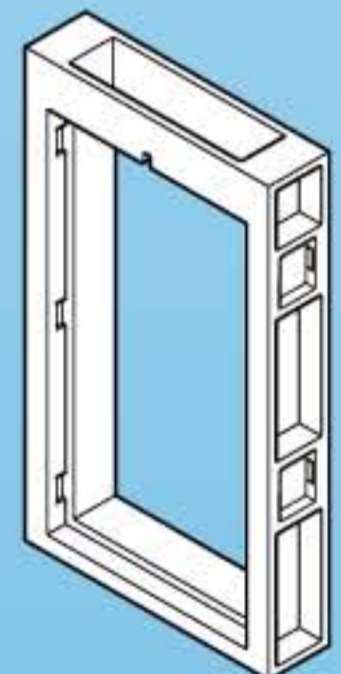

30 22 3932

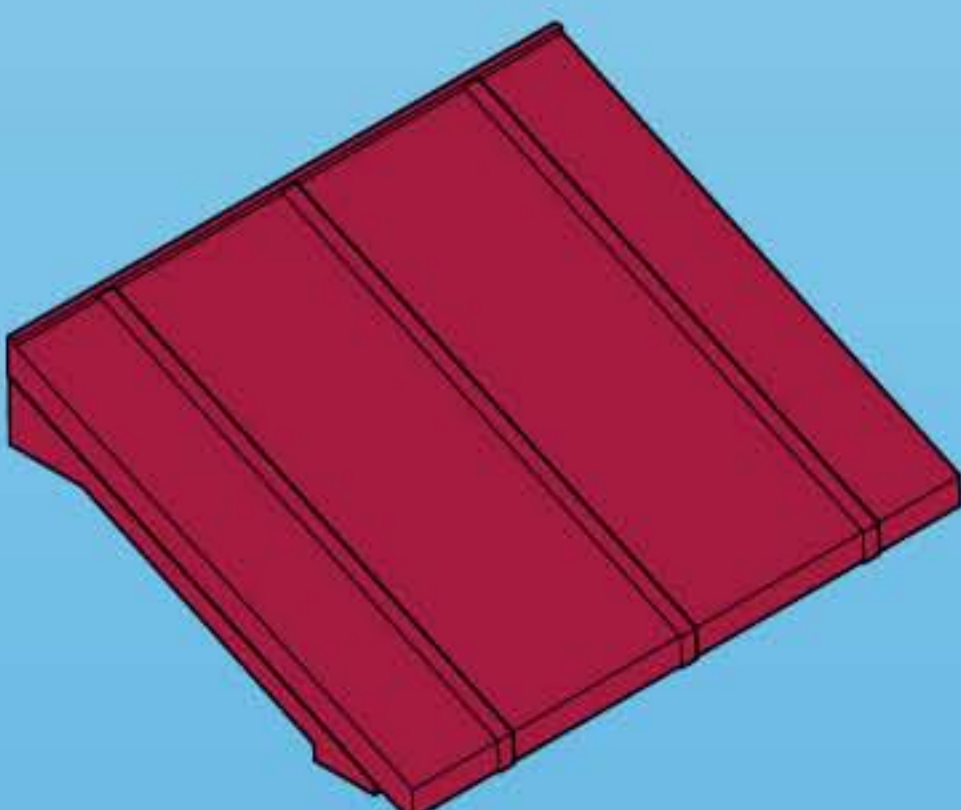

30 22 4072



30 22 3912

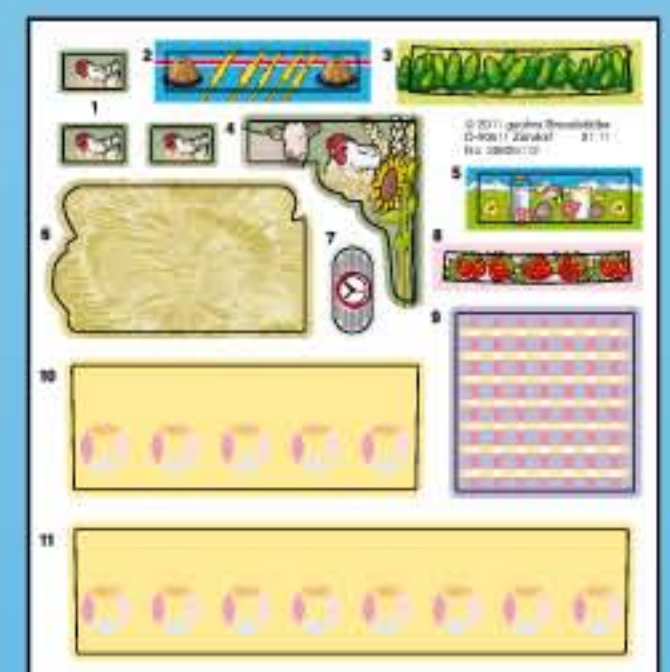

30 82 5112

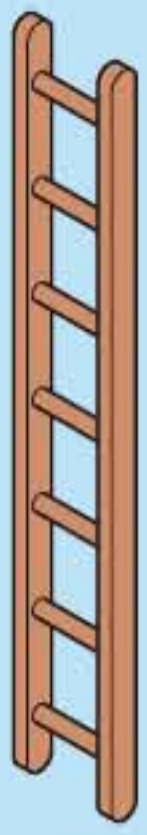

30 23 8630



30 22 4092

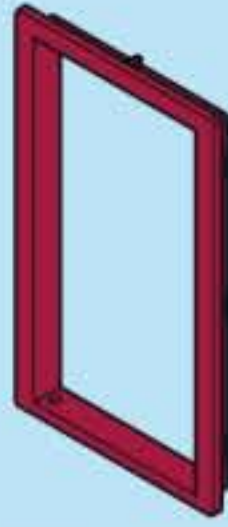

30 22 3952



30 22 4182



30 22 3972



30 25 6550

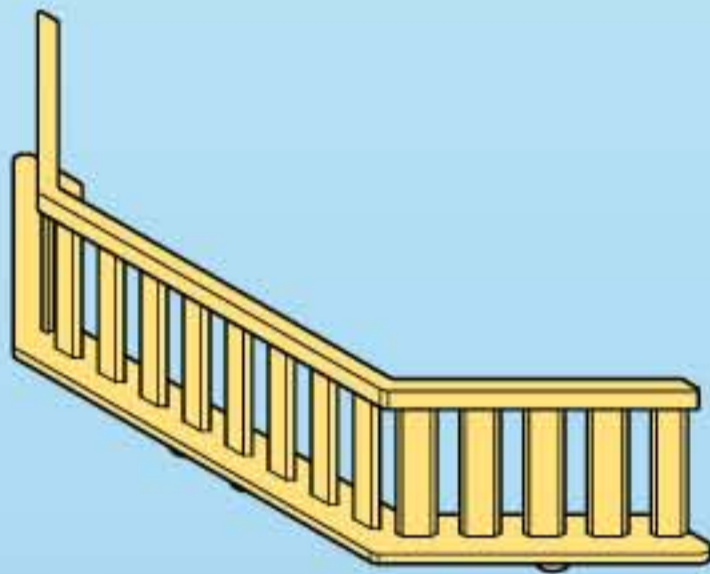

30 22 3892



30 28 8830

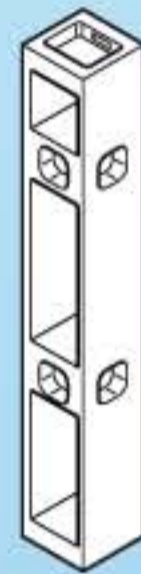

30 22 3922

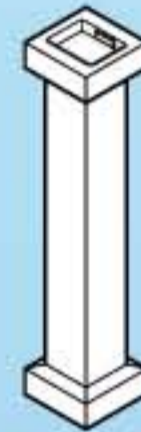

30 29 5870



30 22 3862



2x 30 22 4082



2x 30 22 4222

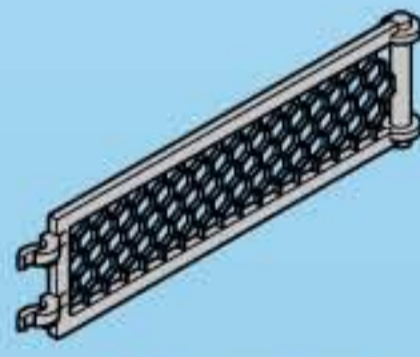

6x 30 22 4202

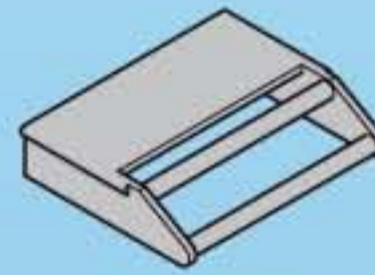

30 24 8300



30 24 8030



2x 30 21 4422

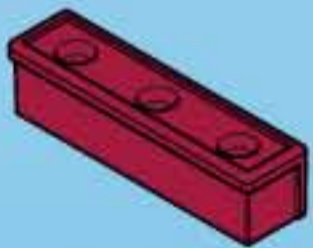

2x 30 23 4322



2x 30 28 7650



30 24 3640



30 29 5950



2x 30 22 1290



2x 30 21 1072

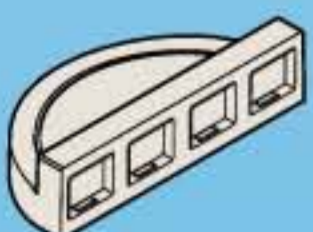

30 22 3872



30 22 3942

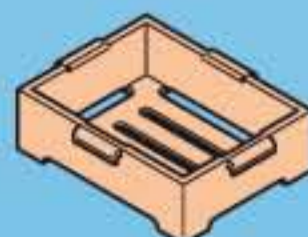

3x 30 23 1030



30 09 7050



3x 30 23 1050



30 80 5350

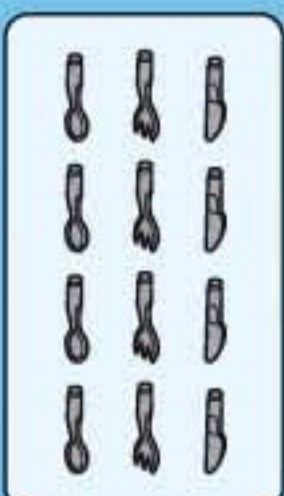

30 51 6832

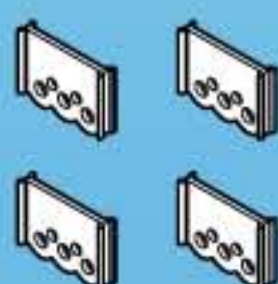

30 51 9140



30 24 5430



30 25 2680



30 08 9730



30 89 5582



30 65 8822



30 20 5030



2x 30 22 4002



30 89 5492



30 89 5412



30 67 1830



2x 30 03 2920



30 09 6820



30 09 6790



2x 30 09 6770



2x 30 09 6830



30 09 6840



2x 30 05 4980



30 61 2170



2x 30 21 4402



30 24 2462



30 22 2192



30 21 2060



30 46 7770



30 46 7760



30 22 4012



30 83 0140



30 05 8610



30 29 2130



30 26 7950



30 23 1730



3x 30 20 9960



2x 30 63 3042



30 25 0080



30 28 7180



4x 30 22 3832



16x 30 03

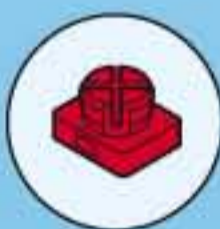

32x 30 09 6900



4x 30 05 9729



6x 30 09 5209

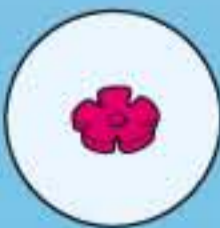

6x 30 05 8719

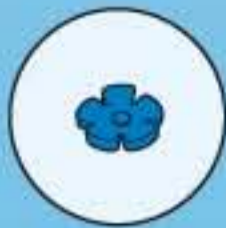

2x 30 22 5859



6x 30 25 1280



6x 30 25 0010



6x 30 25 0020

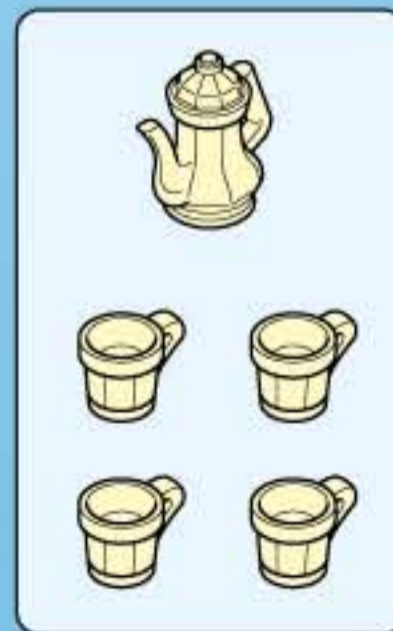

30 51 0582

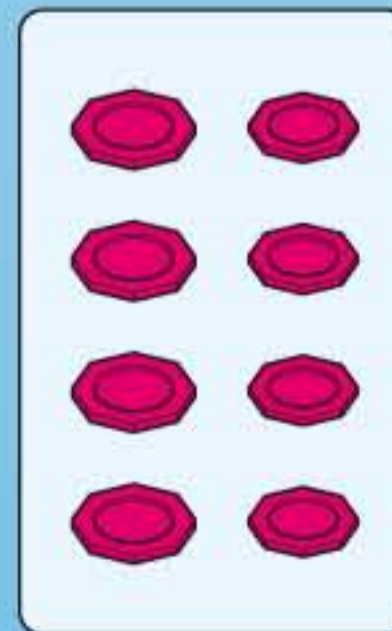

30 51 0382

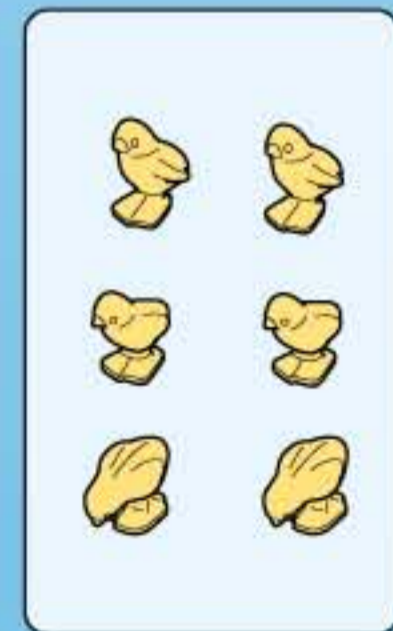

30 51 9150

Serviceadressen finden Sie in allen Playmobil-Prospekten

Addresses of Customer Service Departments are shown in all Playmobil catalogues

L'adresse du service consommateurs est indiquée dans tous les catalogues Playmobil

Troverete gli indirizzi dei centri di assistenza in tutti i cataloghi Playmobil

In alle PLAYMOBIL catalogi vindt u het adres van onze klantendienst.

Las Direcciones de los Departamentos de Servicio al Consumidor se encuentran en todos los catálogos Playmobil

Η διεύθυνση του Γραφείου Εξυπηρέτησης Καταναλωτών PLAYMOBIL βρίσκεται σε όλους τους καταλόγους PLAYMOBIL.

pronounce: plāy-mō-bēēl

