



WARNING:
CHOKING HAZARD
Small parts. Not for children under 3 years.

"Ne concerne que les USA/CDN"

Wichtige Unterlagen, bitte sorgfältig aufbewahren!
Important documents keep carefully!
Documents importants conservez avec soin!
Belangrijke documenten, bewaar deze zorgvuldig!

1

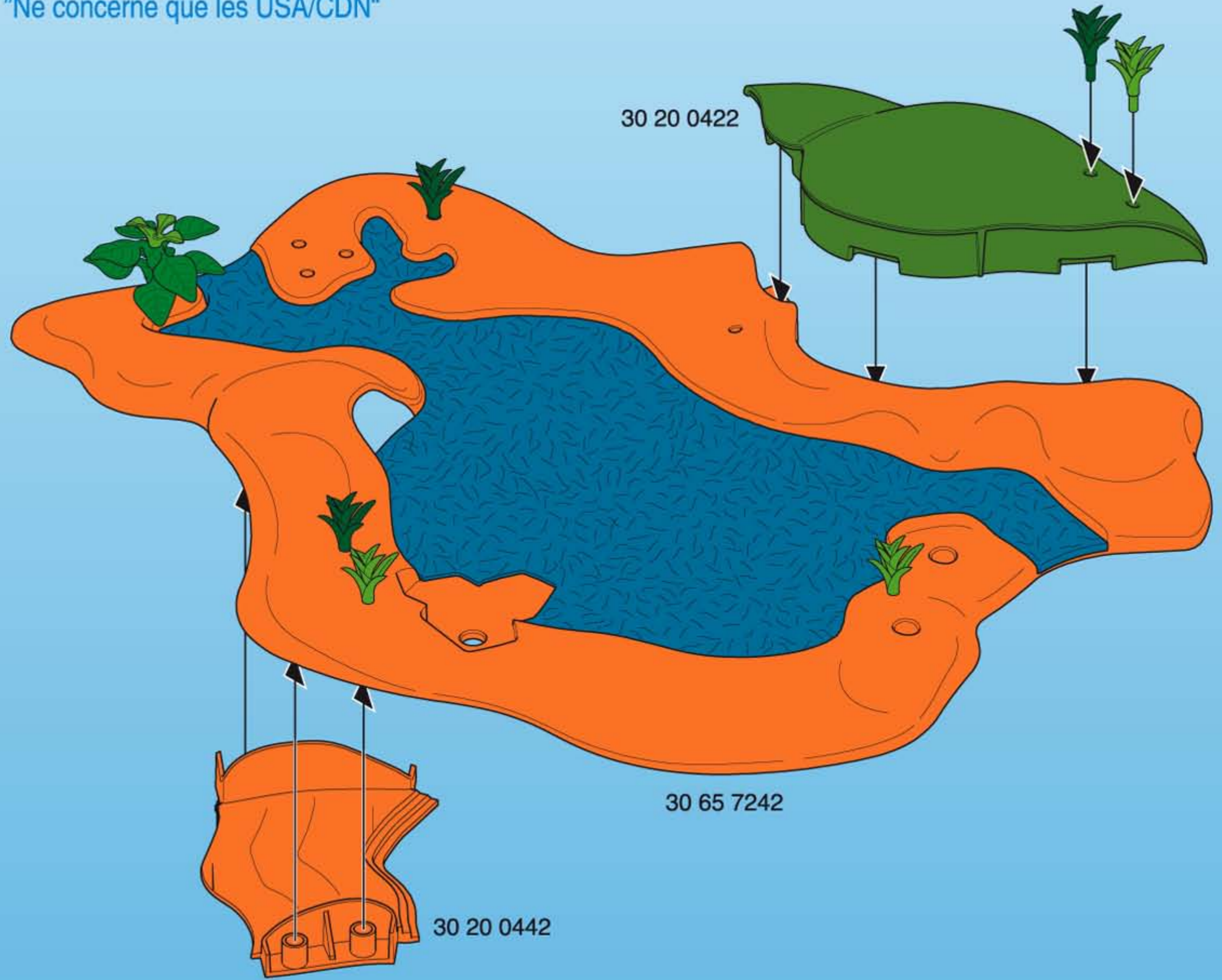
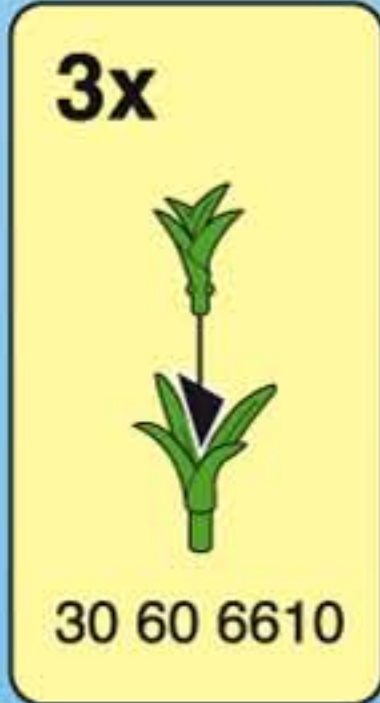
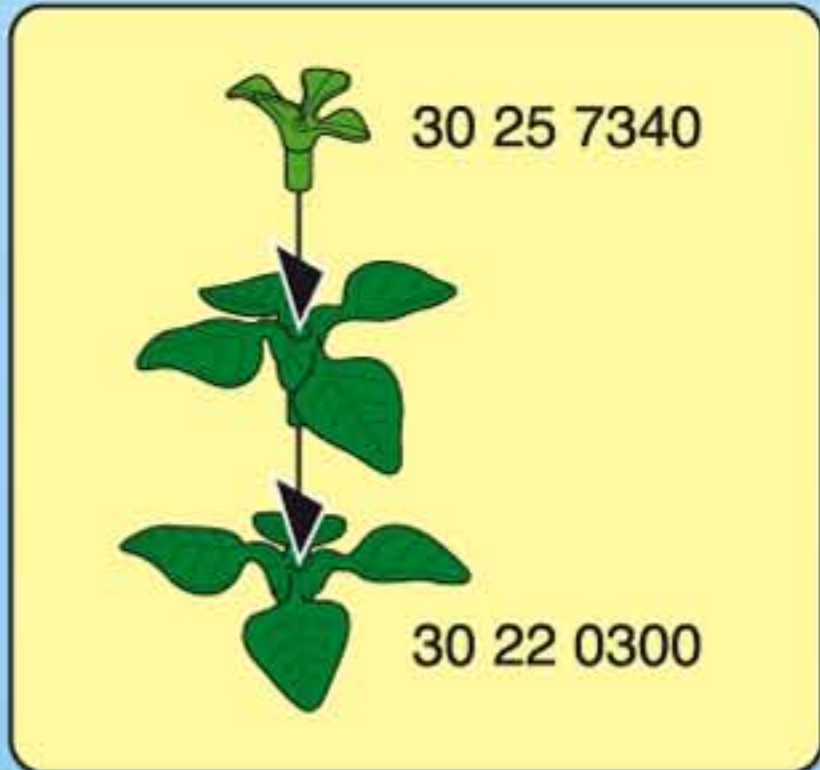

2

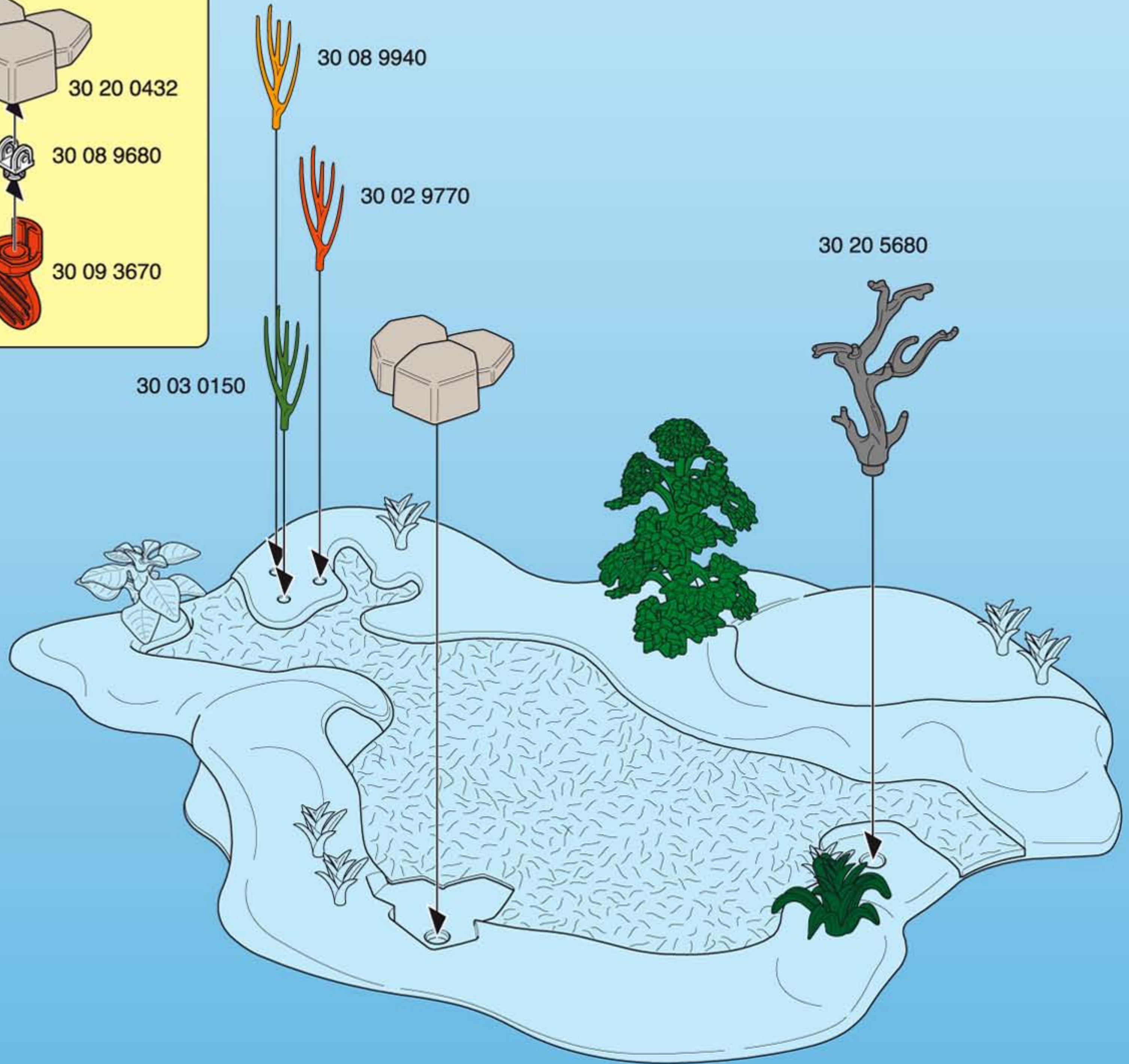
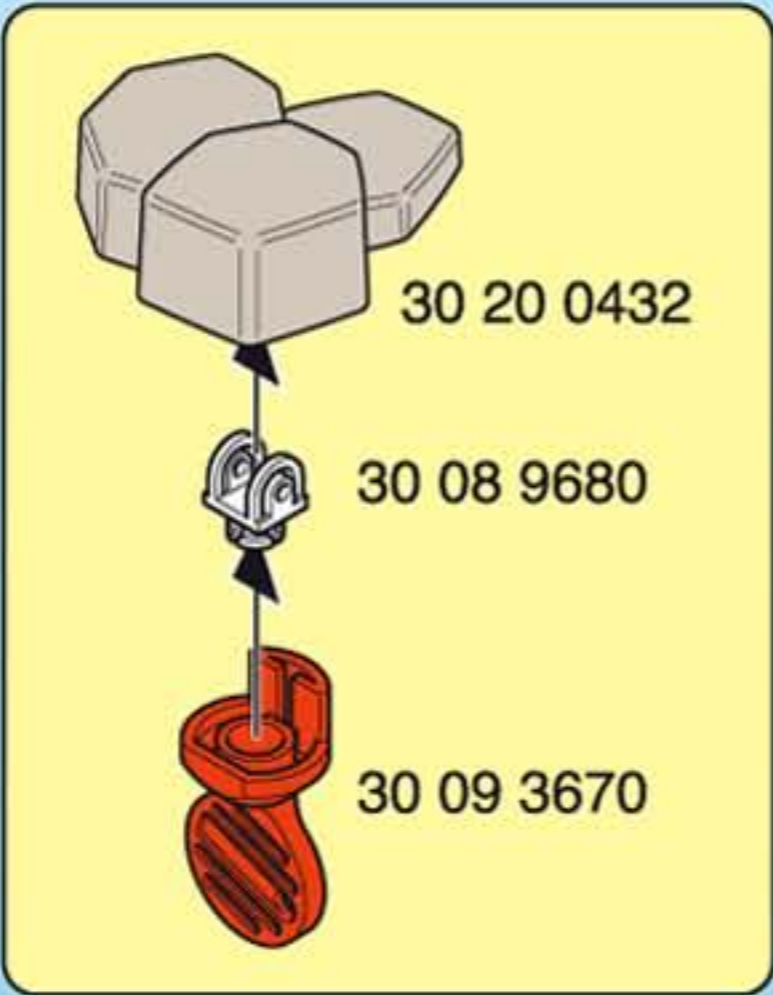
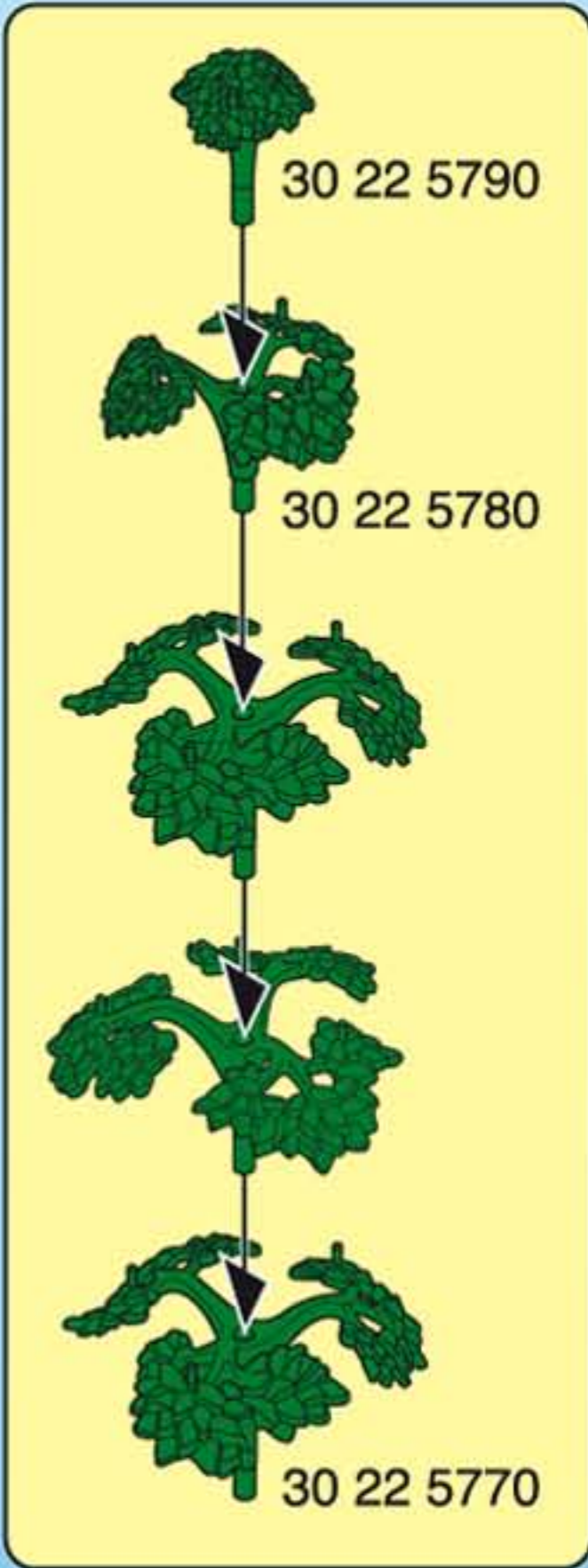

1

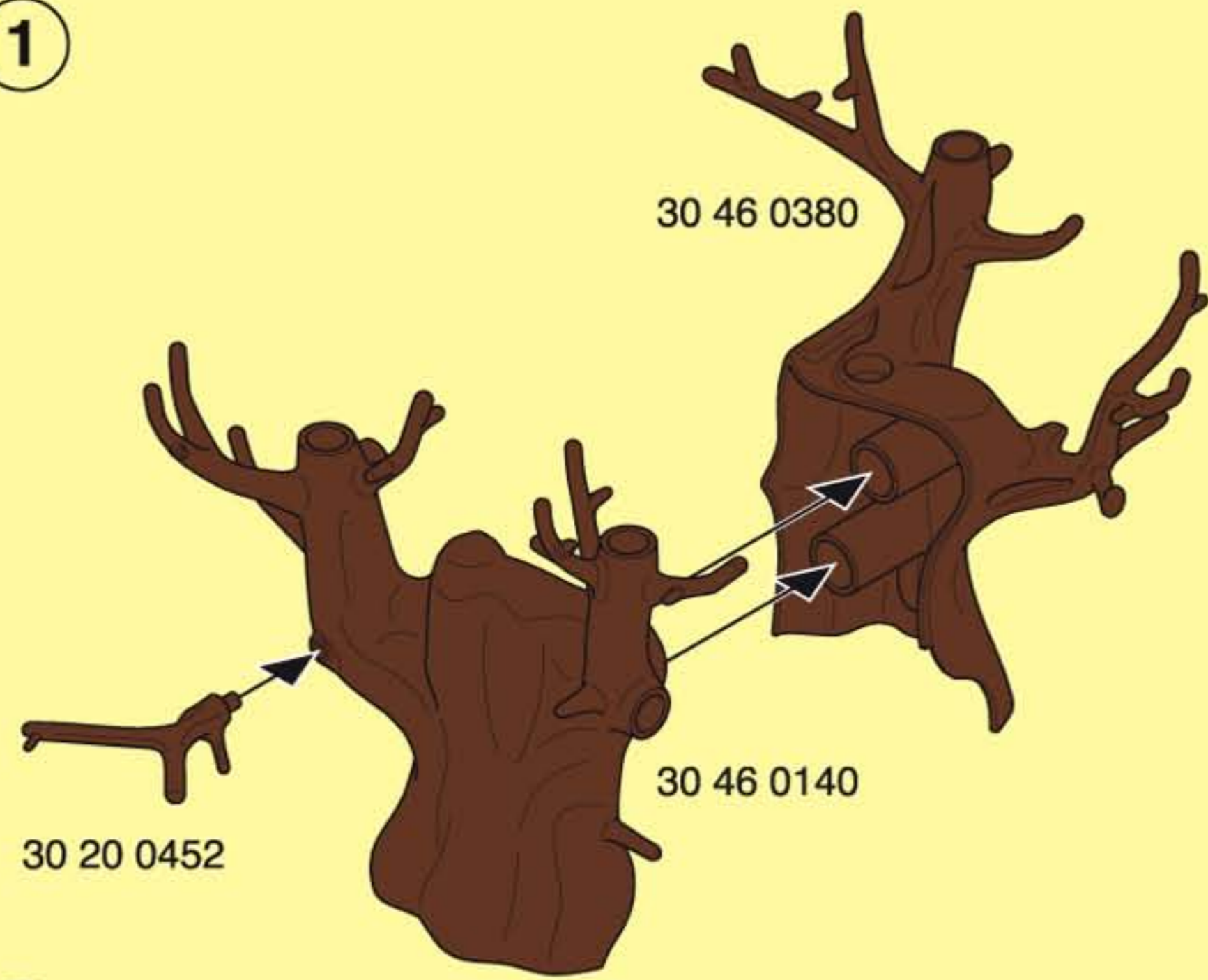

2

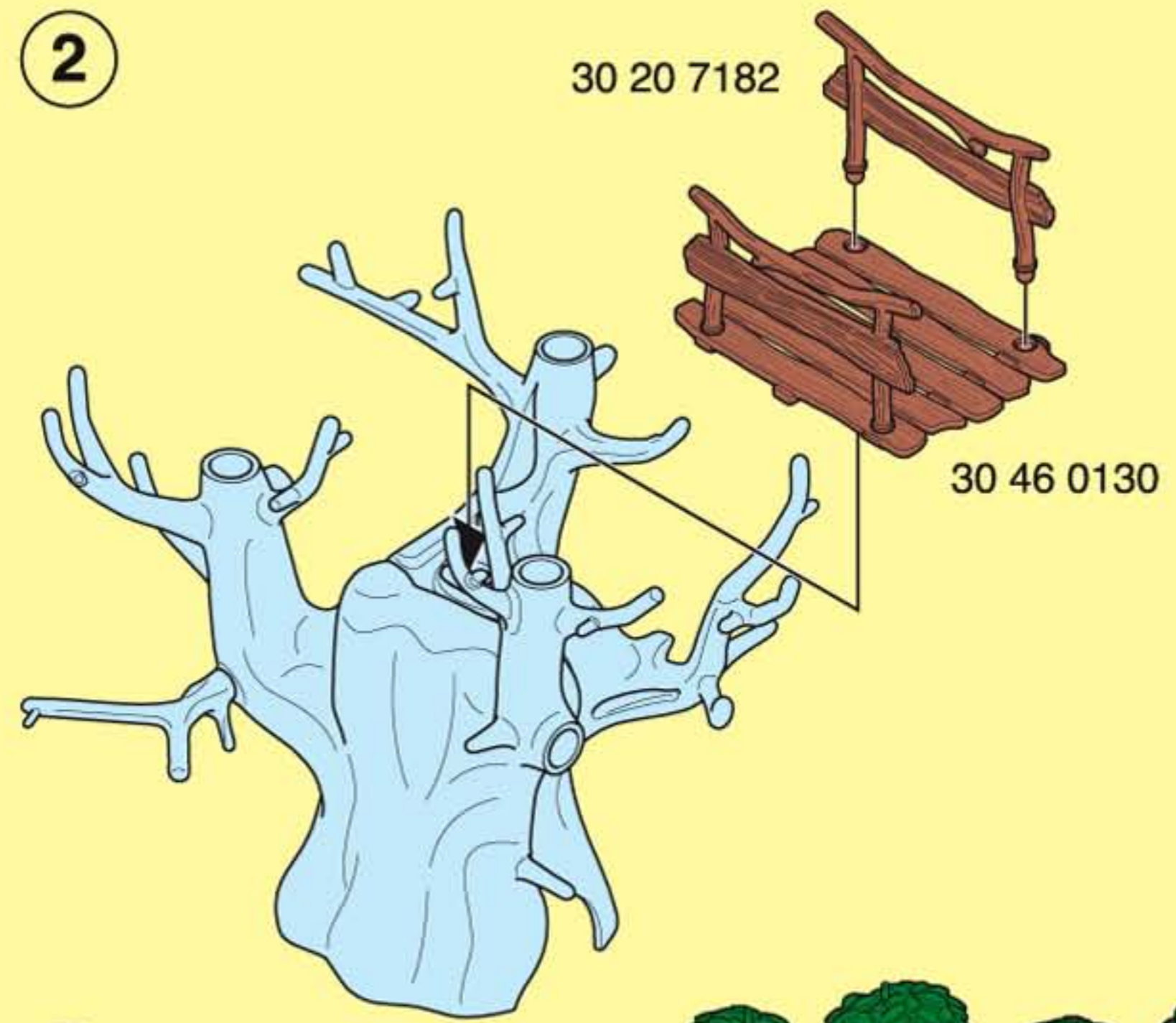

3

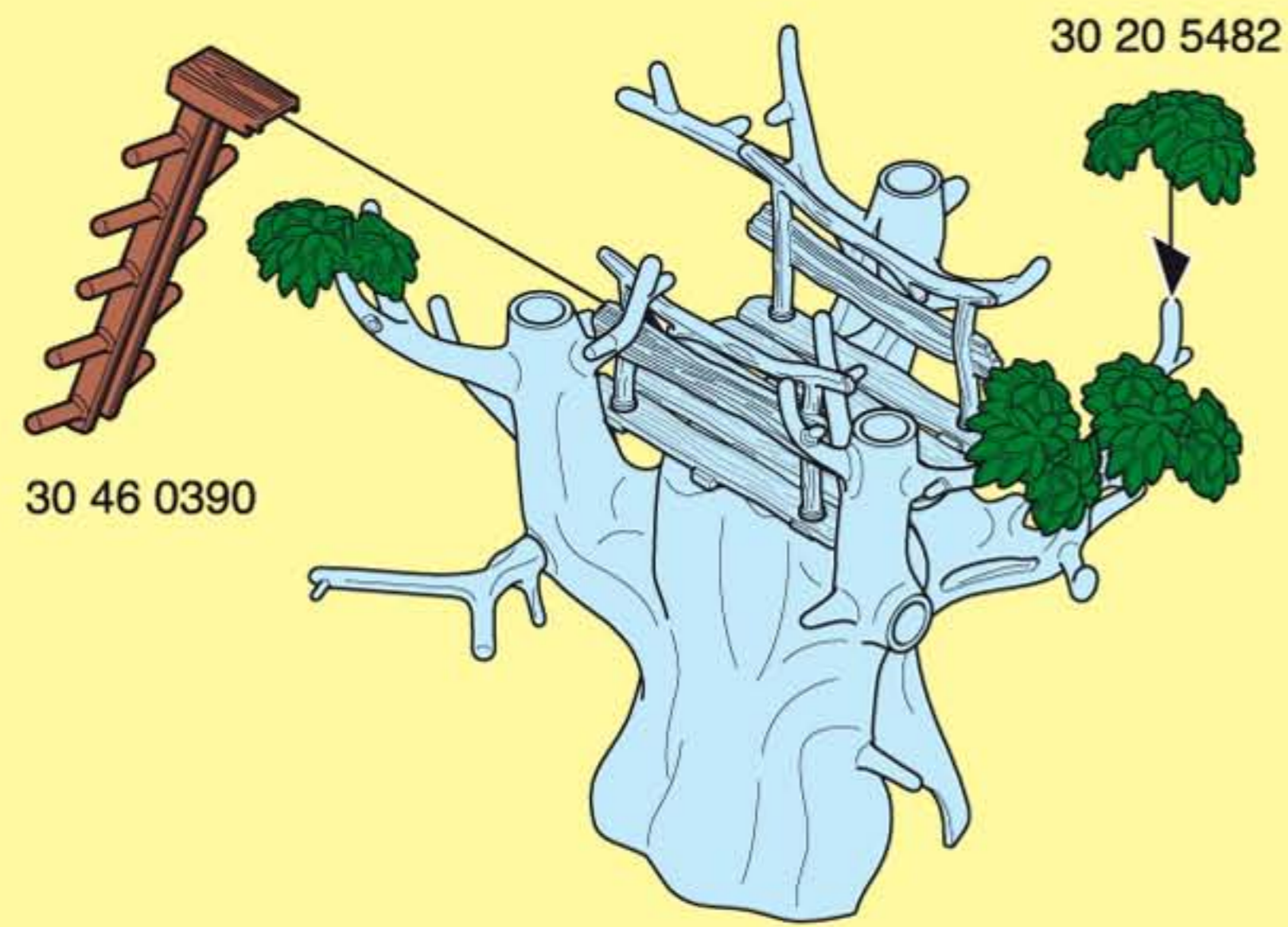

4

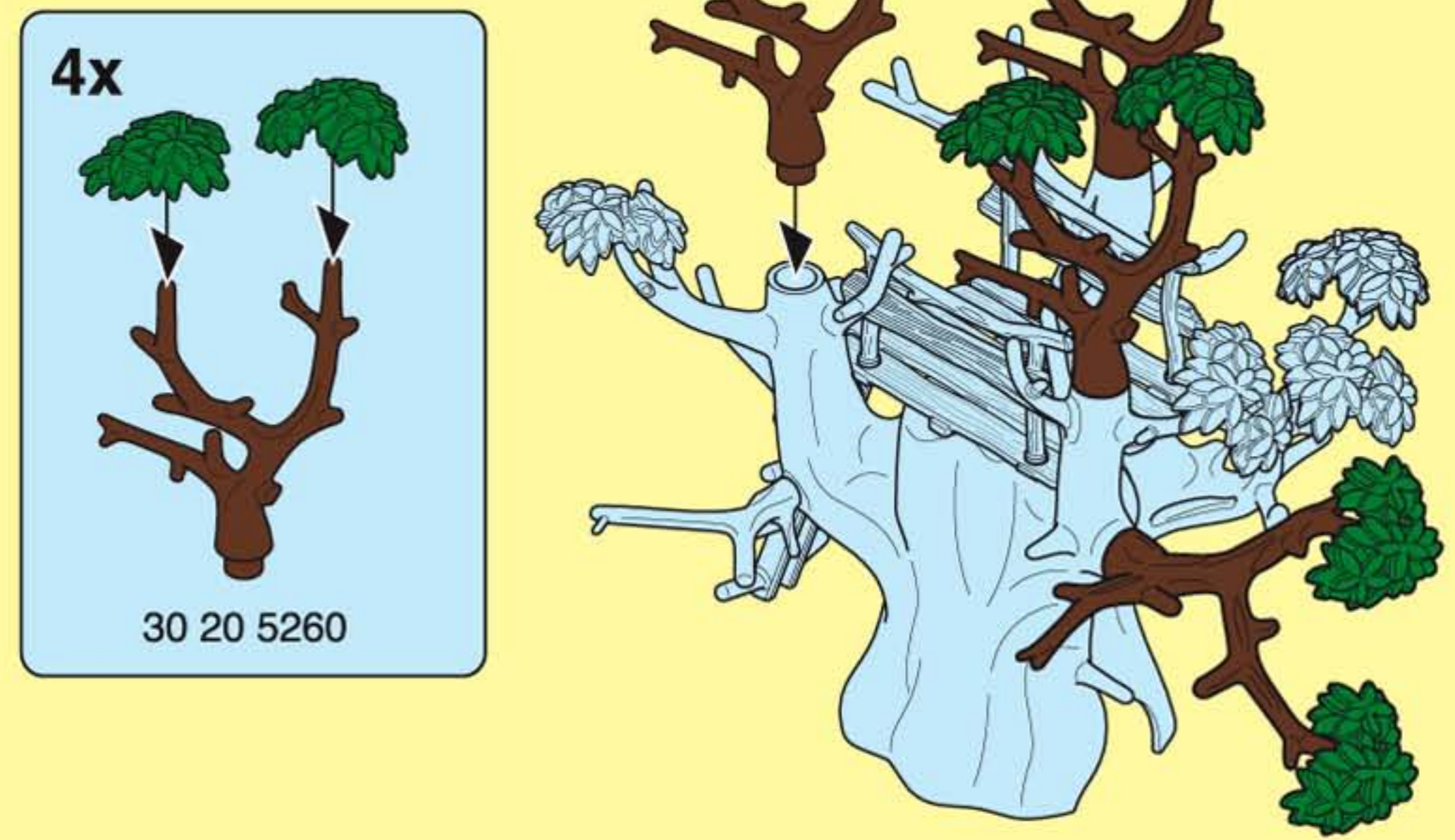

2x

30 65 7232



30 29 9850

30 07 3849



30 07 3820



30 14 4160



30 26 0570



30 26 0380



30 67 0860



30 83 0440



30 83 0010

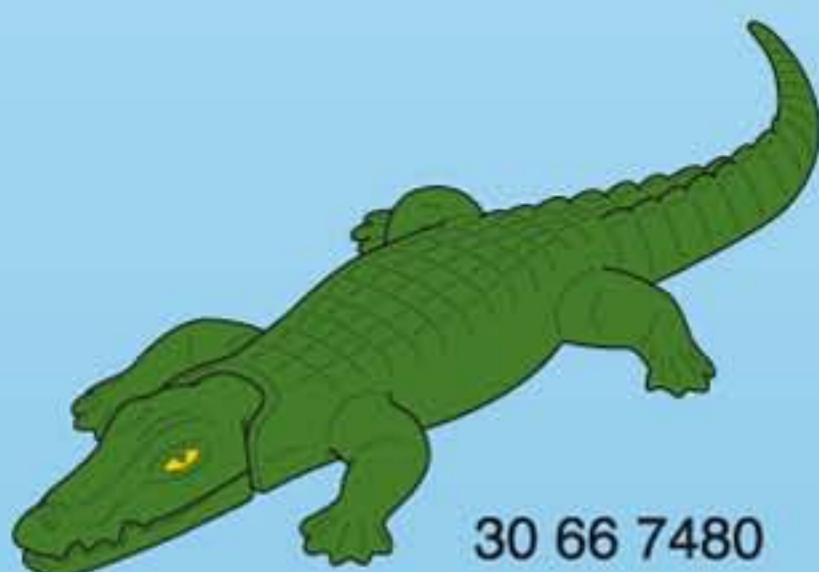

30 66 7480



30 62 3762



30 65 7222



30 66 4590

Serviceadressen finden Sie in allen Playmobil-Prospekten

Addresses of Customer Service Departments are shown in all Playmobil catalogues

L'adresse du service consommateurs est indiquée dans tous les catalogues Playmobil

Troverete gli indirizzi dei centri di assistenza in tutti i cataloghi Playmobil

In alle PLAYMOBIL catalogi vindt u het adres van onze klantendienst.

Las Direcciones de los Departamentos de Servicio al Consumidor se encuentran en todos los catálogos Playmobil

Η διεύθυνση του Γραφείου Εξυπηρέτησεως Πελατών είναι καταχωρημένη σε όλους τους καταλόγους Playmobil

pronounce: plāy-mō-bēēl

(D) (A) (CH) (L) (B) ACHTUNG! Nur unter Aufsicht und nur in flachem Wasser benutzen.

(USA) (GB) (CDN) (M) (IRL) WARNING! Only to be used in water in which the child is within its depth and under supervision

(F) (CDN) (B) (L) (CH) ATTENTION! À n'utiliser qu'en eau où l'enfant a pied et sous surveillance.

(E) (MEX) ¡ ADVERTENCIA! Se deberá utilizar solamente en el agua, donde el niño haga pie y bajo vigilancia.

(NL) (B) WAARSCHUWING! Alleen gebruiken onder toezicht, in water waarin het kind kan staan.

(I) (CH) ATTENZIONE! Utilizzare solo in acque dove il bambino tocca con i piedi e sotto sorveglianza.

(P) AVISO! Utilizar apenas em águas em que a criança tenha pé e sob vigilância.

(DK) ADVARSEL! Må kun anvendes under opsyn og på vanddybder, hvor barnet kan bunde.

(N) ADVARSEL! Skal kun brukes i vann som ikke er for dypt for barnet, og der barnet er under tilsyn.

(S) (FIN) VARNING! Får endast användas på grunt vatten och under uppsikt av vuxen.

(FIN) VAROITUS! Käytetään ainoastaan matalassa vedessä, jossa lapsi voi seistä ja on aikuisen valvonnassa.

(H) FIGYELMEZTETÉS! Mély vízben nem használható! Kérjük, kizárólag szülői felügyelettel használja kis vízben!

(CZ) VAROVÁNÍ! Používáť pouze v mělké vodě a pod dohledem!

(EST) HOIATUS! Kasutamiseks ainult vees, kus lapse jalad ulatuvad põhja ja täiskasvanu järelevalve all.

(LV) BRĪDINĀJUMS! Lietojams tikai sekļā ūdenī un uzraudzībā.

(LT) DĖMESIO! Naudoti prižiūrint suaugusiesiems ir tokiame gylje, kur vaikas gali stovėti.

(SLO) OPOZORILO! Uporabljeni samo v plitvi vodi in pod nadzorom.

(SK) UPOZORNENIE! Používať len vo vode primerane hĺbokej dieťaťu a pod dohľadom.

(PL) UWAGA! Tylko do użytku w wodzie płytkiej i pod nadzorem.

(TR) (CY) ΔΙΚΚΑΤ! Sadece denetim altında ve sadece alçak sularda kullanın.

(GR) (CY) ΠΡΟΣΟΧΗ! Να χρησιμοποιείται μόνο σε νερά όπου πατώνει το παιδί και κάτω από επίβλεψη.

(RO) AVERTIZARE! Se folosește doar sub supraveghere și doar în apă mică.

(BG) ПРЕДУПРЕЖДЕНИЕ! Да се използва само под наблюдение и в плитки води.

(CN) 警告! 可供孩子在水中使用，但必须在有人监护的情况下。