

playmobil®

3900



WARNING:
CHOKING HAZARD

Small parts. Not for children under 3 years.

"Ne concerne que les USA"

Wichtige Unterlagen, bitte sorgfältig aufbewahren !
Important: Please keep these instructions for future reference !
Documents importants, à conserver soigneusement !
Belangrijke documenten, bewaar deze zorgvuldig !

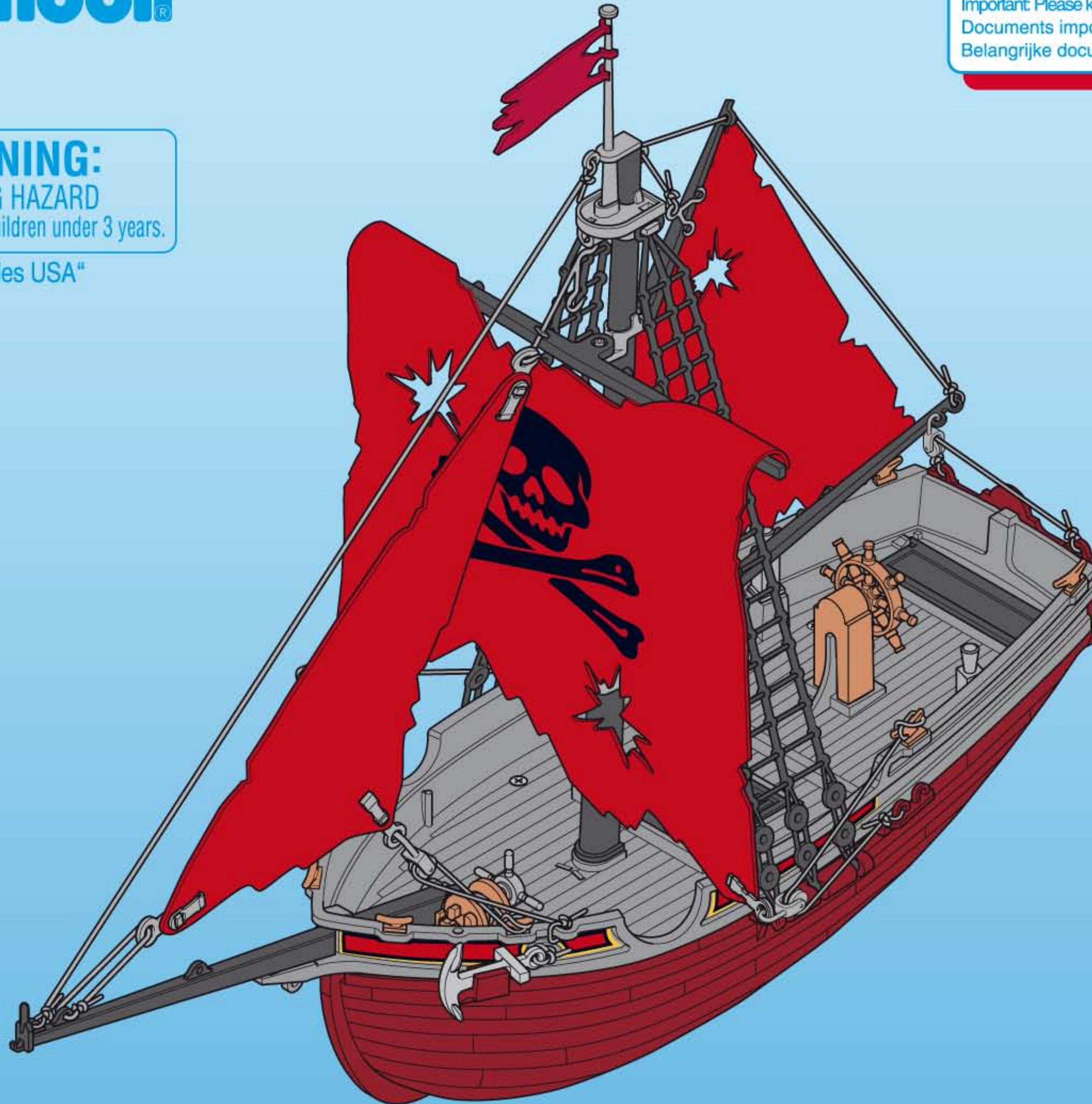

1

1 30 61 4410

30 89 7552
50 cm / (19,7 inch)

2 30 61 2230

3 30 61 5110

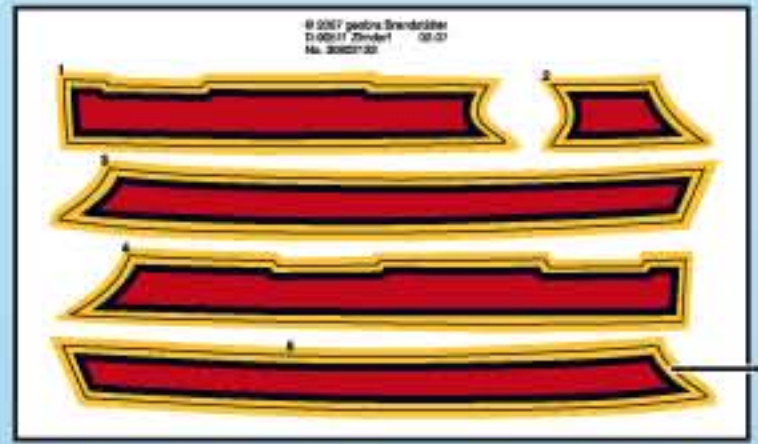

30 80 2132

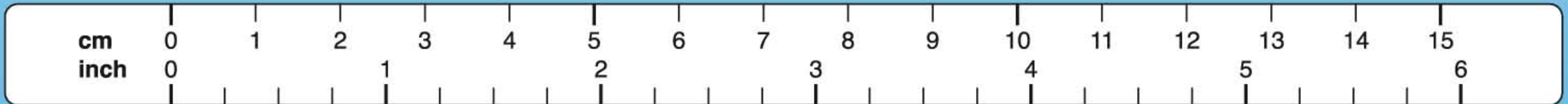
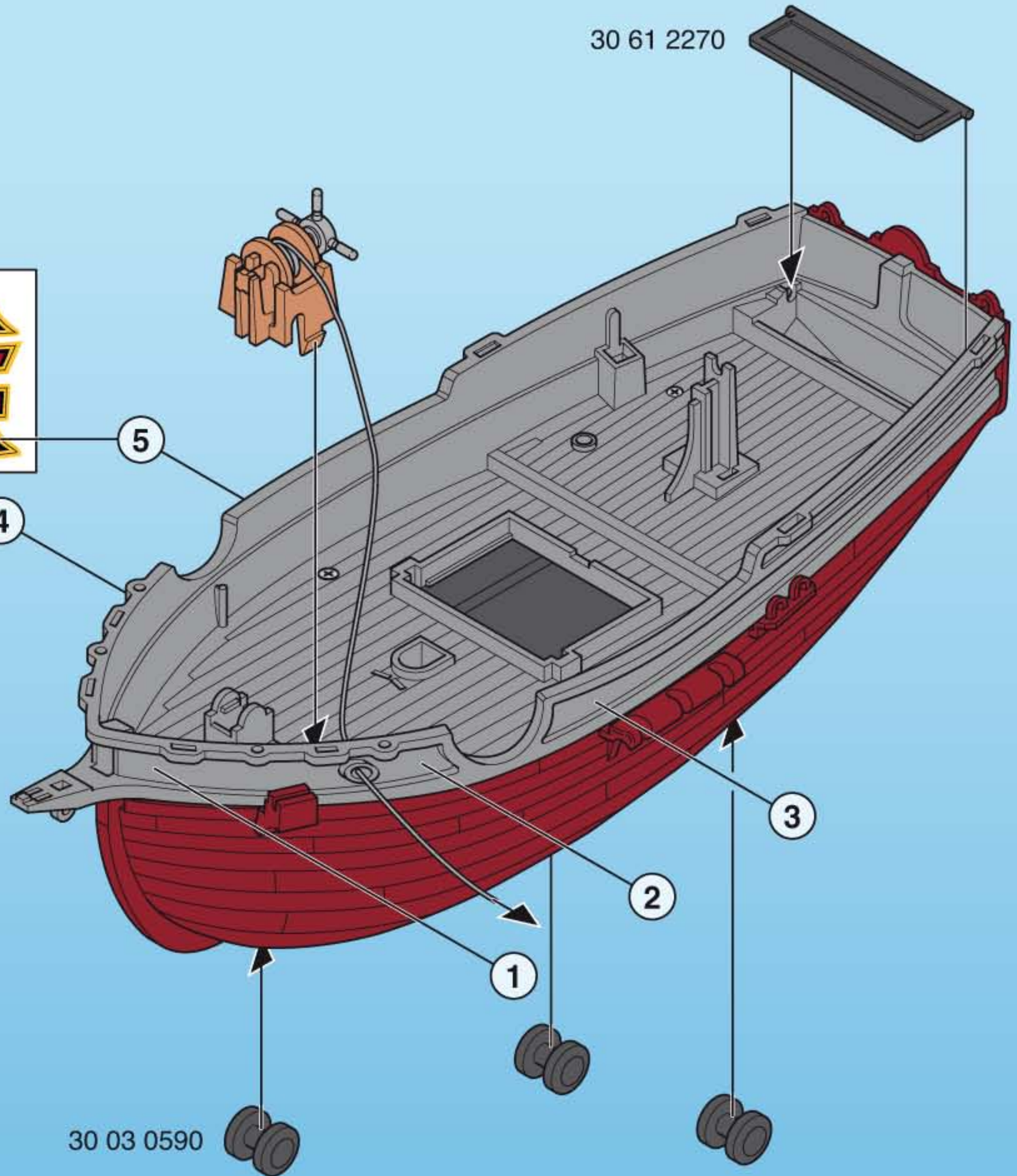

2

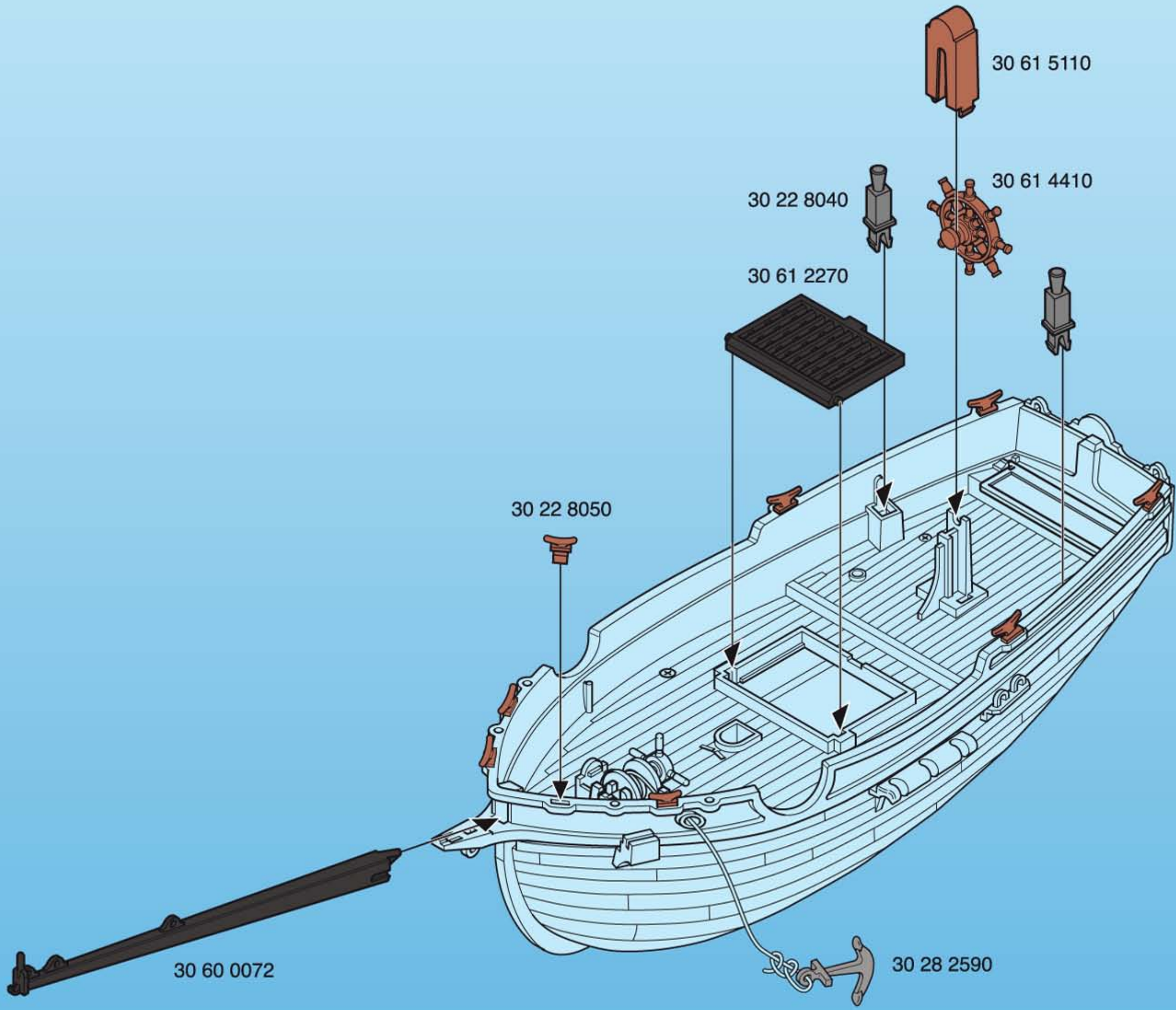

1

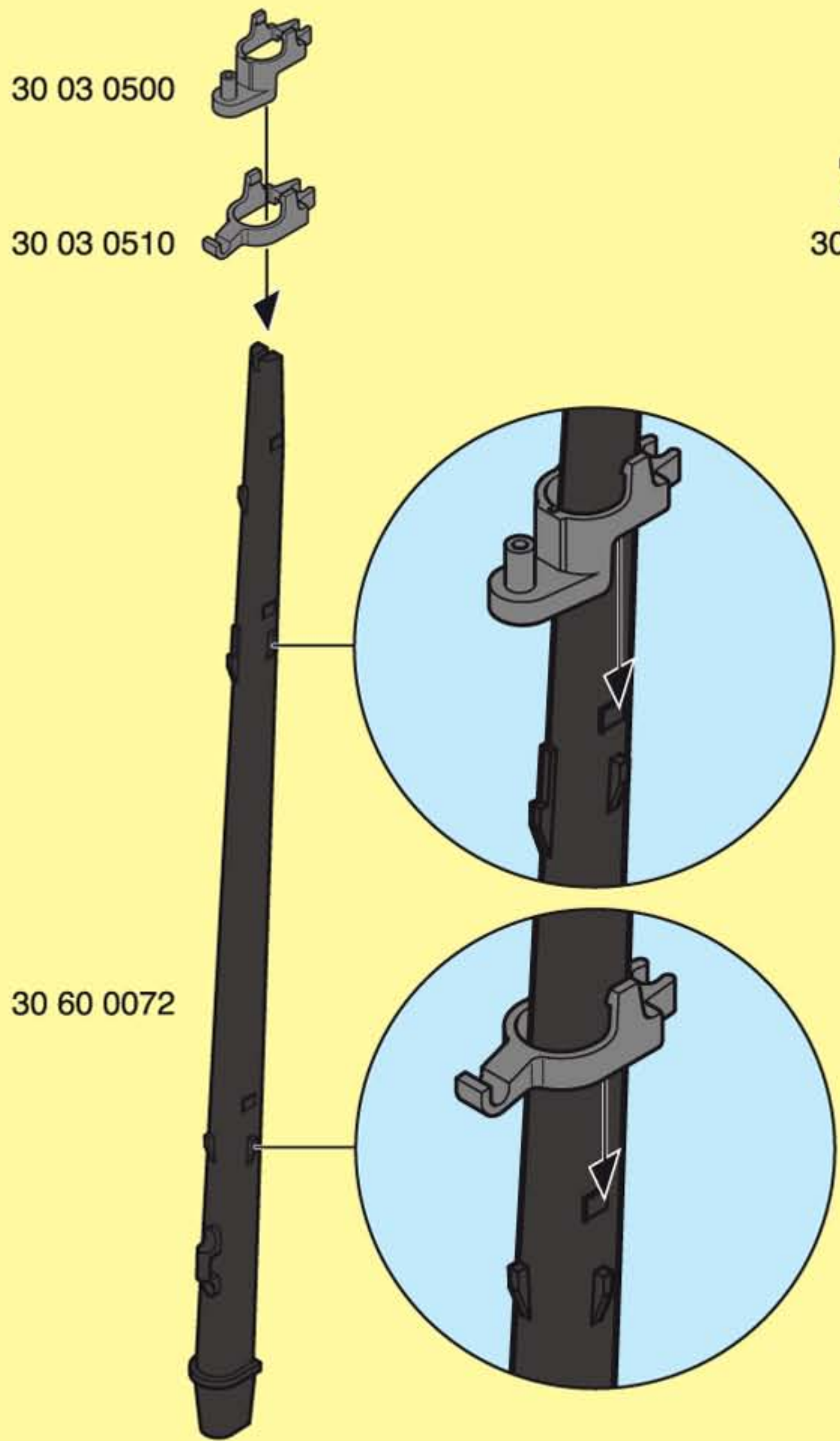

2

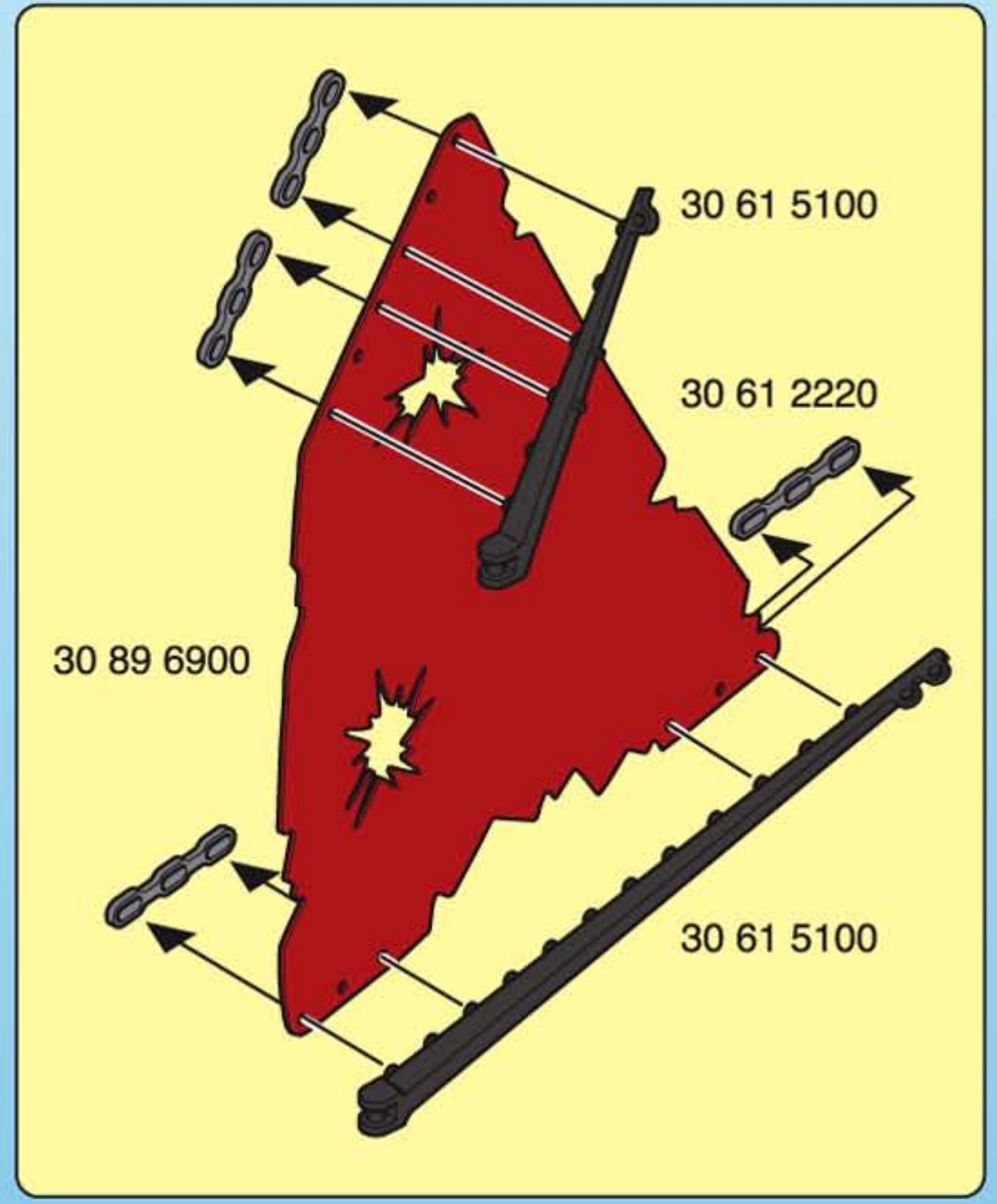
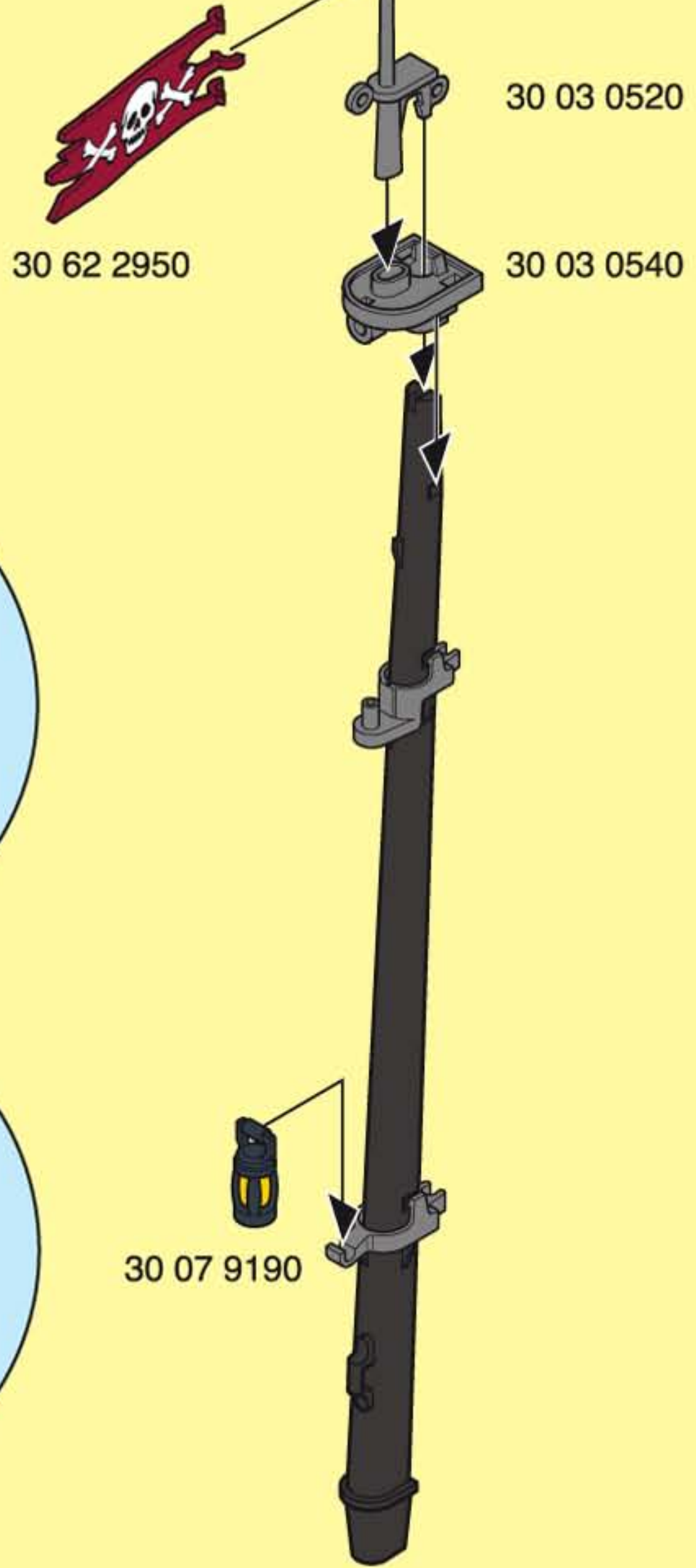

3

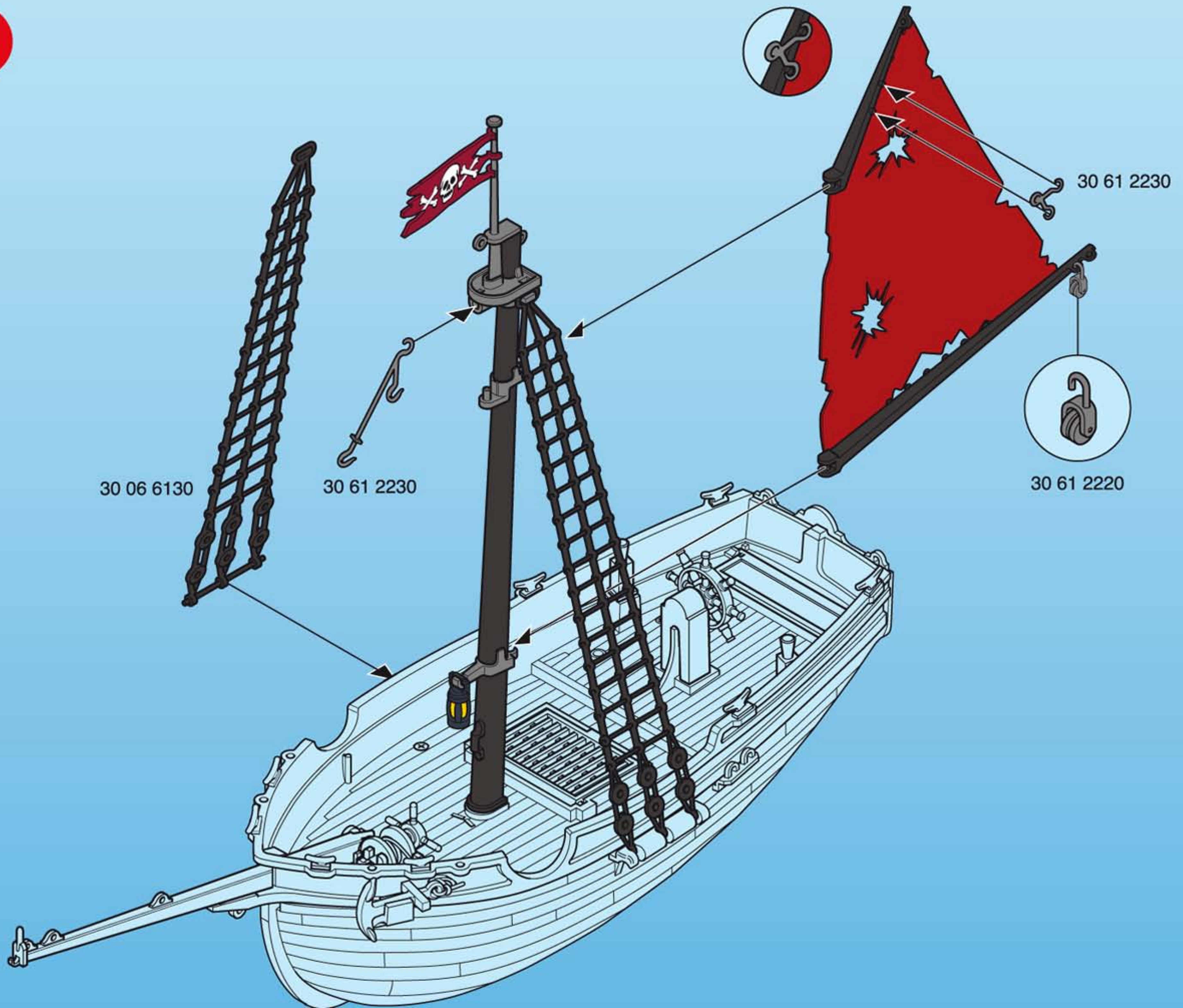

4

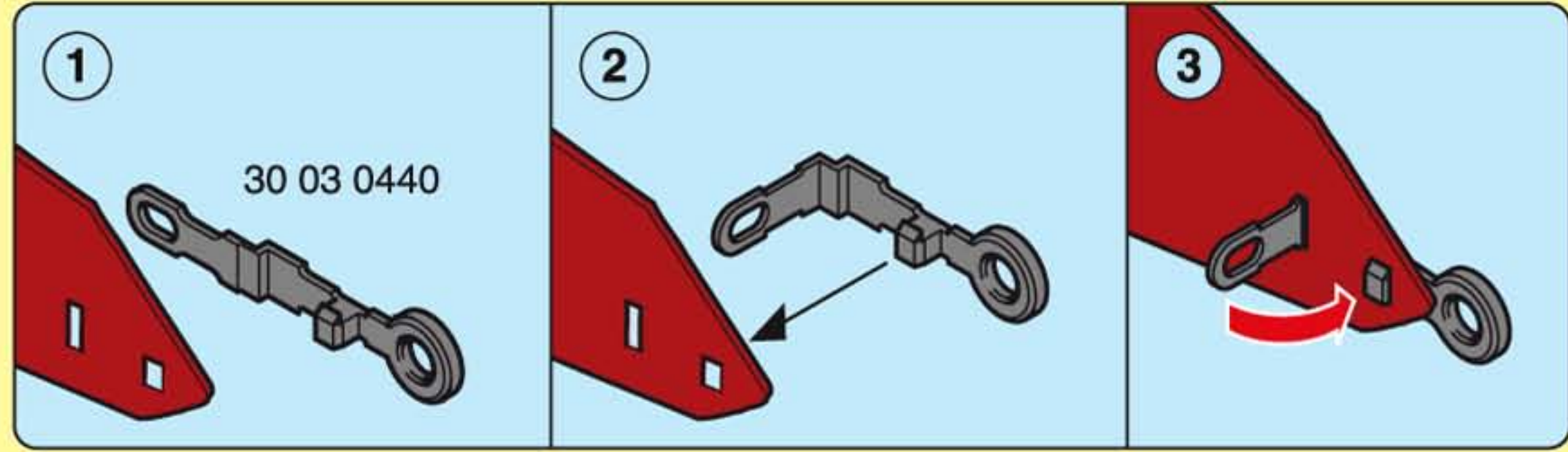



5

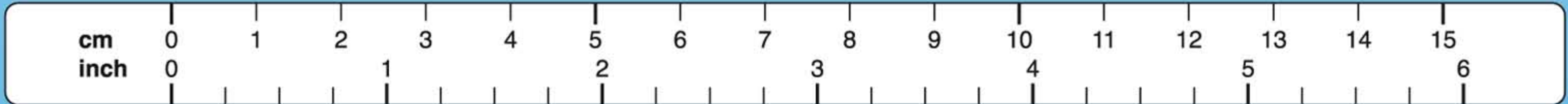
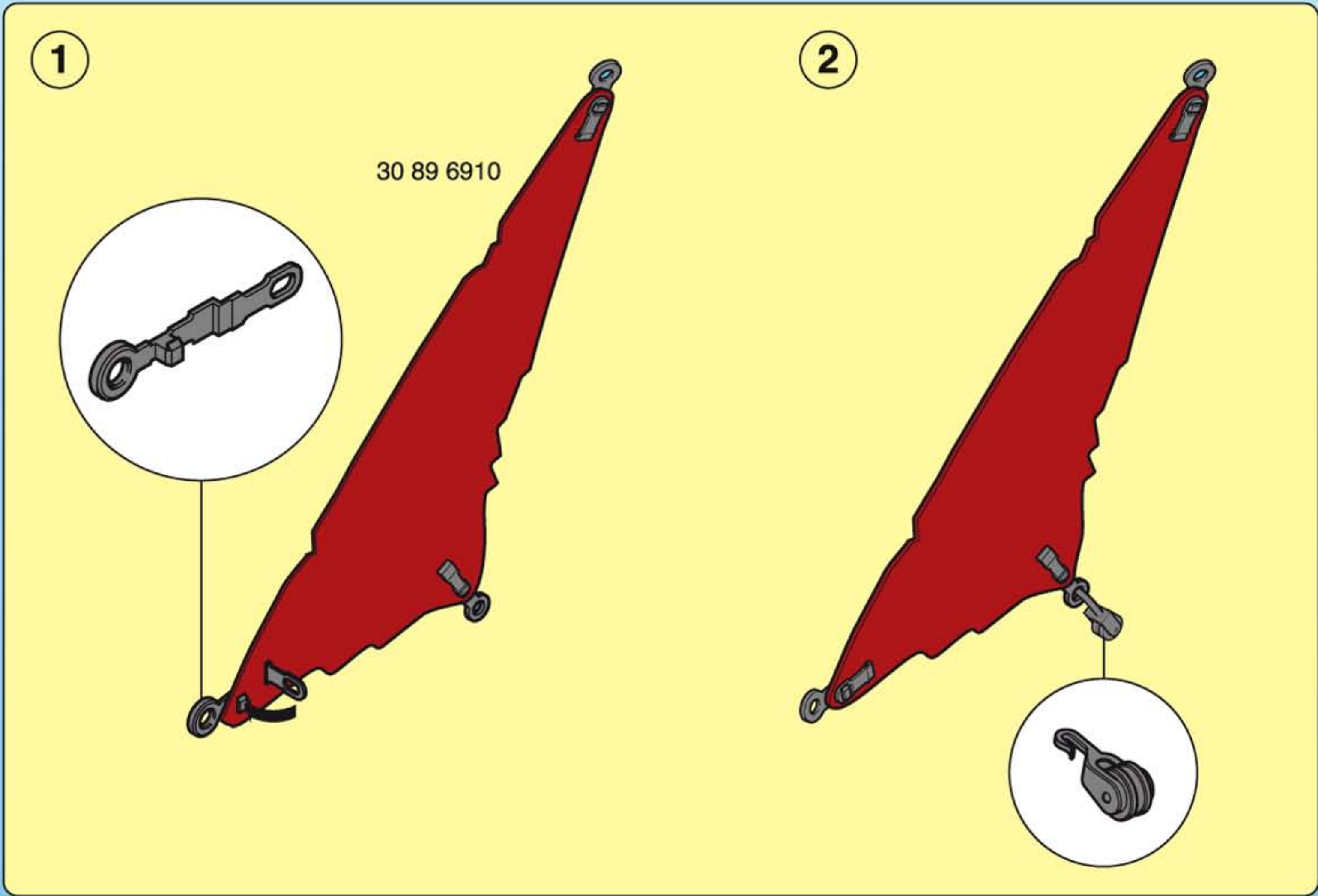

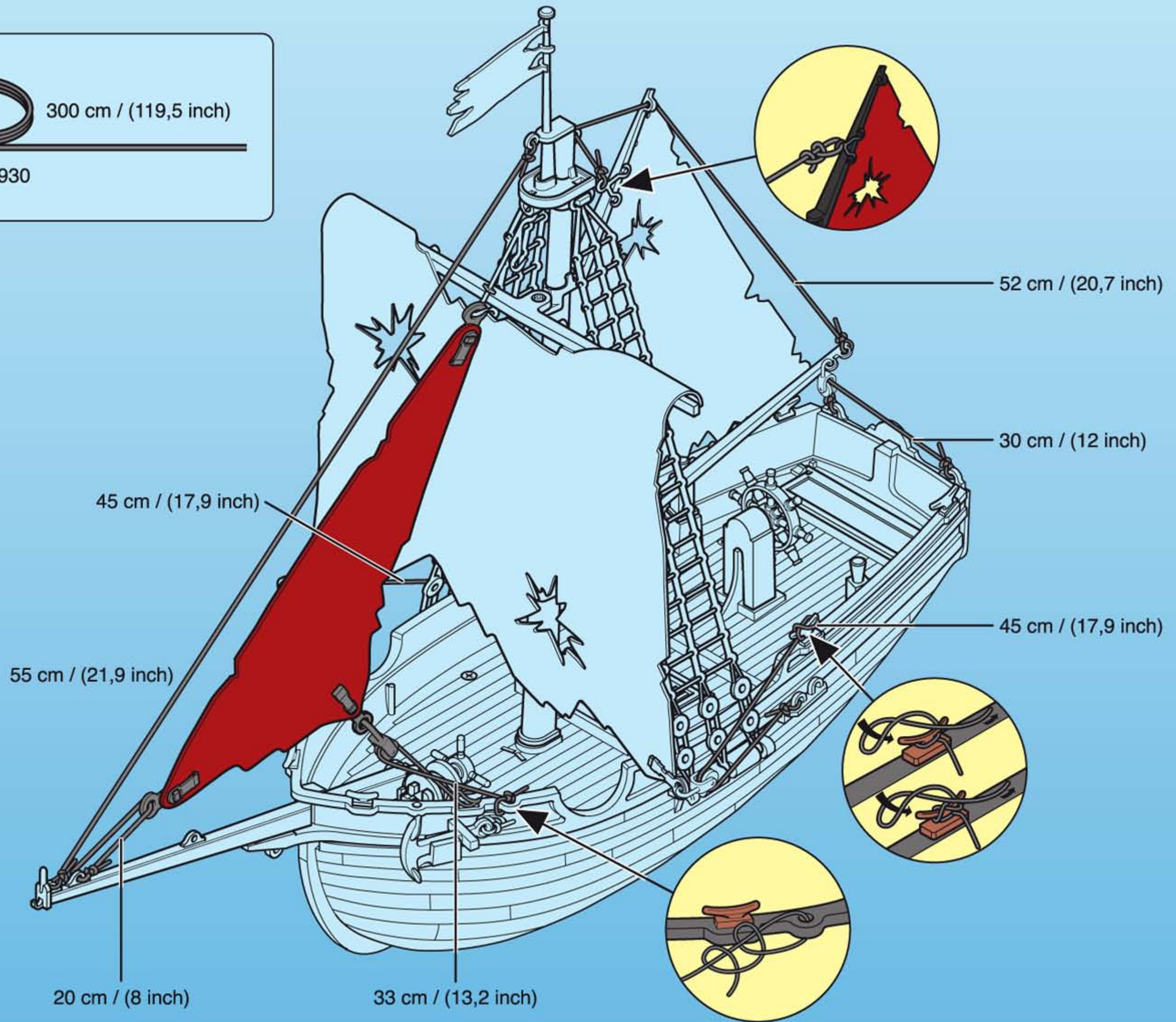
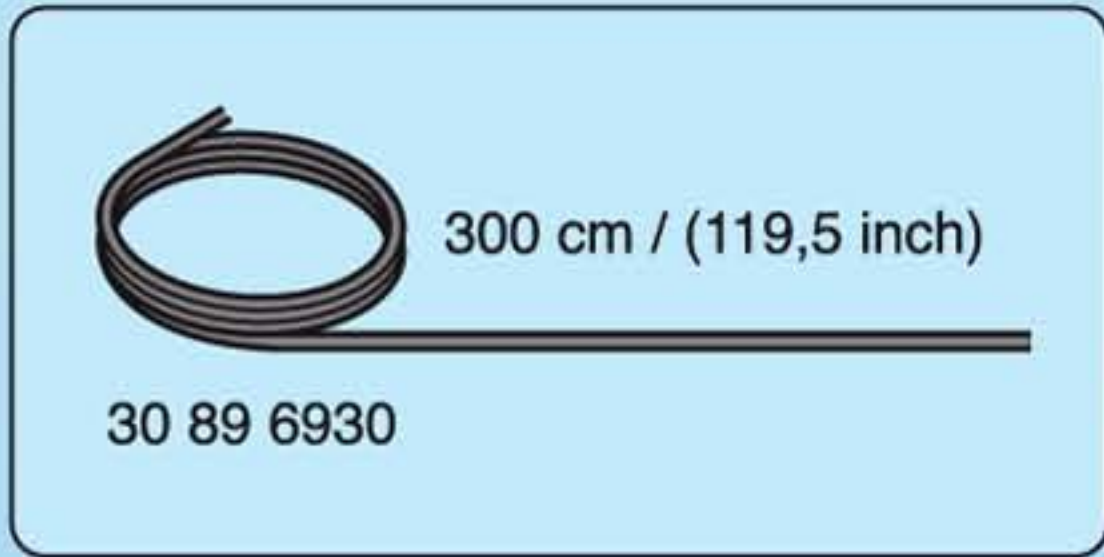

(D) (A) (CH) (L) (B) ACHTUNG!

- Nur im flachen Wasser unter Aufsicht von Erwachsenen verwenden.
- Nur mitgelieferte PLAYMOBIL Geschosse verwenden. Nicht auf Augen oder Gesicht zielen.

(USA) (GB) (CDN) (M) (IRL) WARNING!

- Only to be used in water in which the child is within its depth and under adult supervision.
- Only use the PLAYMOBIL projectiles supplied. Do not aim at eyes or face.

(F) (CDN) (B) (L) (CH) ATTENTION!

- À n'utiliser qu'en eau où l'enfant a pied et sous la surveillance d'un adulte.
- Seulement utiliser les projectiles PLAYMOBIL fournis. Ne pas viser les yeux ou le visage

(E) (MEX) ¡ADVERTENCIA!

- Utilizar sólo en agua donde el niño pueda permanecer de pie y bajo vigilancia de un adulto.
- Utiliza únicamente los proyectiles PLAYMOBIL suministrados. No apuntar a los ojos ni a la cara.

(NL) (B) WAARSCHUWING!

- Gebruiken in water waar kinderen kunnen staan en onder toezicht van volwassenen.
- Uitsluitend meegeleverde PLAYMOBIL delen gebruiken. Niet op ogen of gezicht richten.

(I) (CH) AVVERTENZA!

- Da utilizzare unicamente in acqua dove il bambino tocca il fondo con i piedi e sotto la sorveglianza di un adulto.
- Usare soltanto i proiettili PLAYMOBIL in dotazione. Non mirare agli occhi o al viso.

(P) ATENÇÃO!

- Só utilizar em água onde a criança tenha pé e sob vigilância de adultos.
- Usar apenas os projecteis PLAYMOBIL juntamente fornecidos. Não apontar para os olhos ou face.

(DK) ADVARSEL!

- Må kun anvendes under opsyn af en voksen og på vanddybder, hvor barnet kan bunde.
- Anvend kun de medfølgende PLAYMOBIL projektiler. Sig ikke mod øjne eller ansigt.

(N) ADVARSEL!

- Skal kun brukes i vann som ikke er for dypt for barnet, og der barnet er under tilsyn.
- Benytt kun PLAYMOBIL prosjektil som leveres med. Sikt ikke på ansikt eller øyne.

(S) (FIN) VARNING!

- Får endast användas i vatten där barnet bottnar och under tillsyn av en vuxen.
- Använd endast medlevererade PLAYMOBIL-skott. Sikta inte mot ögon eller ansikte.

(FIN) VAROITUS!

- Lelua saa käyttää vain aikuisen valvonnassa vedessä, jossa lapsi ylettyy pohjaan.
- Käytä vain mukana toimitettuja PLAYMOBIL-ammuksia. Ei saa kohdistaa suoraan silmiin tai kasvoihin.

(H) FIGYELMEZTETÉS.

- Csak a gyermek magasságához képest biztonságos sekély vízben és felnőtt felügyelete mellett szabad használni!
- Csak a csomagban található PLAYMOBIL lövedékeket szabad használni. Tilos szemre vagy arcra célozni.

(CZ) UPOZORNĚNÍ!

- Používáť pouze ve vodě takové hloubky, kde dítě stačí, a pouze pod dohledem dospělé osoby.
- Používejte pouze střely PLAYMOBIL, které jsou součástí dodávky. Nemiřte na oči nebo na obličej!

(EST) HOIATUS!

- Kasutada ainult täiskasvanu järelevalve all vees, kus laps ulatub jalgadega põhja.
- Kasutage ainult kaasaantud PLAYMOBIL'i laskemoona. Ära sihi silmadesse ega näkku.

(LV) BRĪDINĀJUMS!

- Lietot tikai seklā ūdenī un pieaugušo uzraudzībā.
- Izmantot tikai PLAYMOBIL piegādes komplektā iekļautos šāviņus. Nevērst pret acīm vai seju.

(LT) ĮSPĖJIMAS!

- Naudoti tik vaikui tinkamame gylyje ir prižiūrint suaugusiesiems.
- Naudokite tik pridedamus PLAYMOBIL šaudmenis. Netaikyti į akis arba veidą.

(SLO) OPOZORILO!

- Uporabljajte samo v vodi, primerno plitvi za otroka in pod nadzorom odrasle osebe.
- Uporabljajte le priložene PLAYMOBIL-ove krogle. Ne merite v oči ali obraz.

(SK) UPOZORNENIE!

- Používať len vo vode, v ktorej dieťa dočiahne na dno, a pod dohľadom dospelej osoby.
- Používajte len náboje dodávané spolu so sadou PLAYMOBIL. Nemieriť do očí alebo do tváre.

(PL) OSTRZEŻENIE!

- Do używania jedynie w wodzie na głębokości, na której dziecko wyczuwa dno pod nogami oraz pod nadzorem osoby dorosłej.
- Stosować tylko załączone PLAYMOBIL - kule / pociski. Nie celować w oczy i twarz.

(TR) (CY) DİKKAT!

- Sadece denetim altında ve sadece alçak sularda kullanın.
- Sadece birlikte verilen PLAYMOBIL mermileri kullanınız. Göze veya yüze doğru tutmayınız.

(GR) (CY) Προειδοποίηση!

- Να χρησιμοποιείται μόνο σε νερά όπου πατώνει το παιδί και υπό την επίβλεψη ενήλικου.
- Να χρησιμοποιούνται αποκλειστικά τα βλήματα της PLAYMOBIL που περιέχονται στη συσκευασία. Μη μην γίνεται στόχευση στα μάτια ή στο πρόσωπο.

(RO) AVERTISMENT!

- A se utiliza numai acolo unde copilul poate sta în picioare în apă și este sub supraveghere.
- Se folosesc doar proiectilele incluse PLAYMOBIL. Nu se țintește în ochi sau în față.

(BG) Внимание!

- Да се използва само във вода, която е дълбока до нормалния ръст на детето, и под надзора на възрастен.
- Използвайте само приложения PLAYMOBIL снаряди. Не насочвайте към очите и лицето.

(HR) UPOZORENJE!

- Koristiti samo u plitkoj vodi pod nadzorom odraslih.
- Upotrijebiti samo od strane PLAYMOBIL-a isporučene projekte. Ne ciljati u oči ili lice.

(CN) 警告!

- 可供孩子在水中使用，但必须在有人监护的情况下。
- 仅能用PLAYMOBIL的炮弹。禁止瞄准眼睛或脸。请勿瞄准眼睛或脸。

2x

30 65 6332

30 22 8070

30 06 3460

1

4x 30 27 4240

2

click

3

1

30 66 2370

2

35 cm / 13,7 inch

30 03 0730

30 88 4110

30 07 5450

30 23 0392

30 07 7820

30 23 4830

30 00 0182

30 20 5810

30 00 7040

30 04 3340

30 62 6230

2x 30 20 9490

30 00 8830



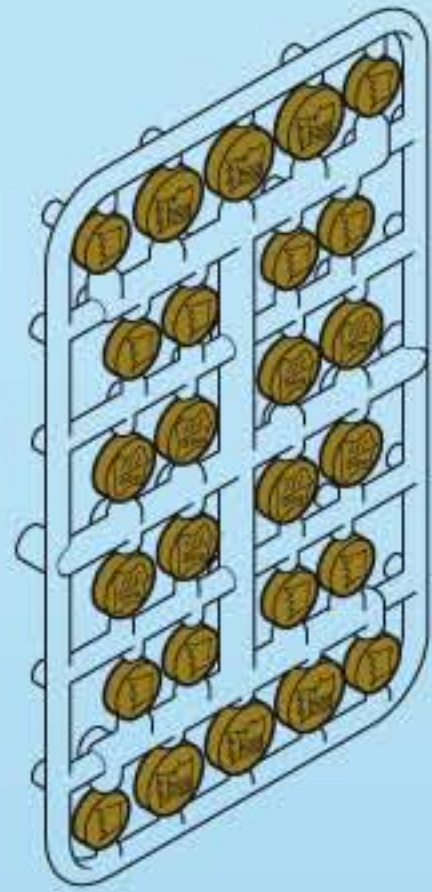

30 61 3730



30 07 2800



30 08 3430



30 65 9340



30 21 8520



30 62 2980



30 06 3690



30 09 5650



30 23 4820



30 06 2180



30 20 5830



30 06 0710



2x 30 09 5440



5x 30 03 0890



30 21 0950



2x 30 20 9400

Serviceadressen finden Sie in allen Playmobil-Prospekten

Addresses of Customer Service Departments are shown in all Playmobil catalogues

L'adresse du service consommateurs est indiquée dans tous les catalogues Playmobil

Troverete gli indirizzi dei centri di assistenza in tutti i cataloghi Playmobil

In alle PLAYMOBIL catalogi vindt u het adres van onze klantendienst.

Las Direcciones de los Departamentos de Servicio al Consumidor se encuentran en todos los catálogos Playmobil

Η διεύθυνση του Γραφείου Εξυπηρέτησης Καταναλωτών PLAYMOBIL βρίσκεται σε όλους τους καταλόγους PLAYMOBIL.

pronounce: plāy-mō-bēēl



www.playmobil.com

© 2008 geobra Brandstätter Stiftung & Co.KG
Brandstätterstr. 2-10
90513 Zirndorf, Germany.
No. 30 81 6072 02.18