

**playmobil**  
3664

**WARNING:**  
CHOKING HAZARD - SMALL PARTS  
Not for children under 3 years.

"Ne concerne que les USA"

Wichtige Unterlagen, bitte sorgfältig aufbewahren!  
Important documents keep carefully!  
Documents importants conservez avec soin!



**7350**

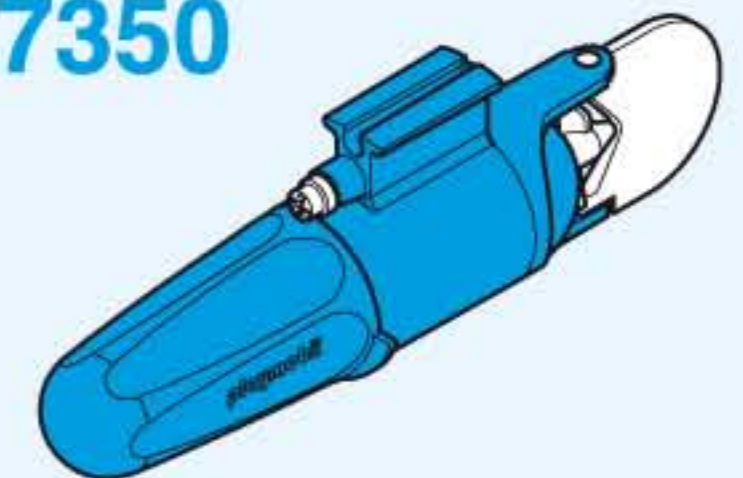

- Nachrüstbar mit Unterwassermotor
- Refittable with underwatermotor
- Moteur submersible, vendu séparément, s'adapte sur ce bateau



1

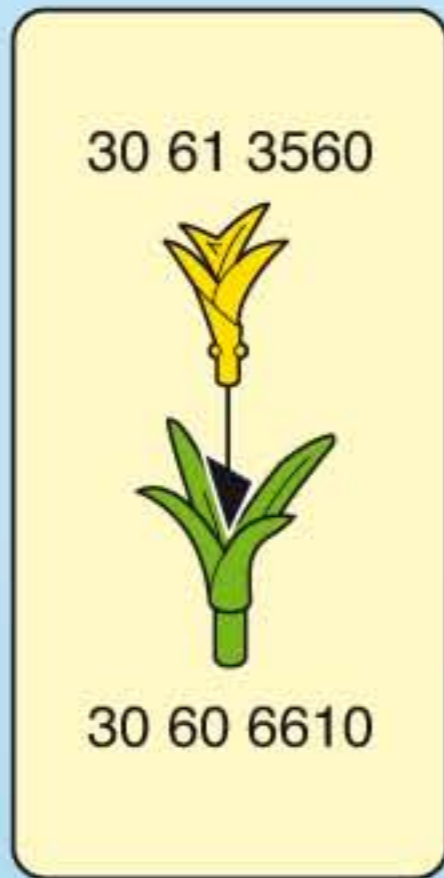

30 62 8262

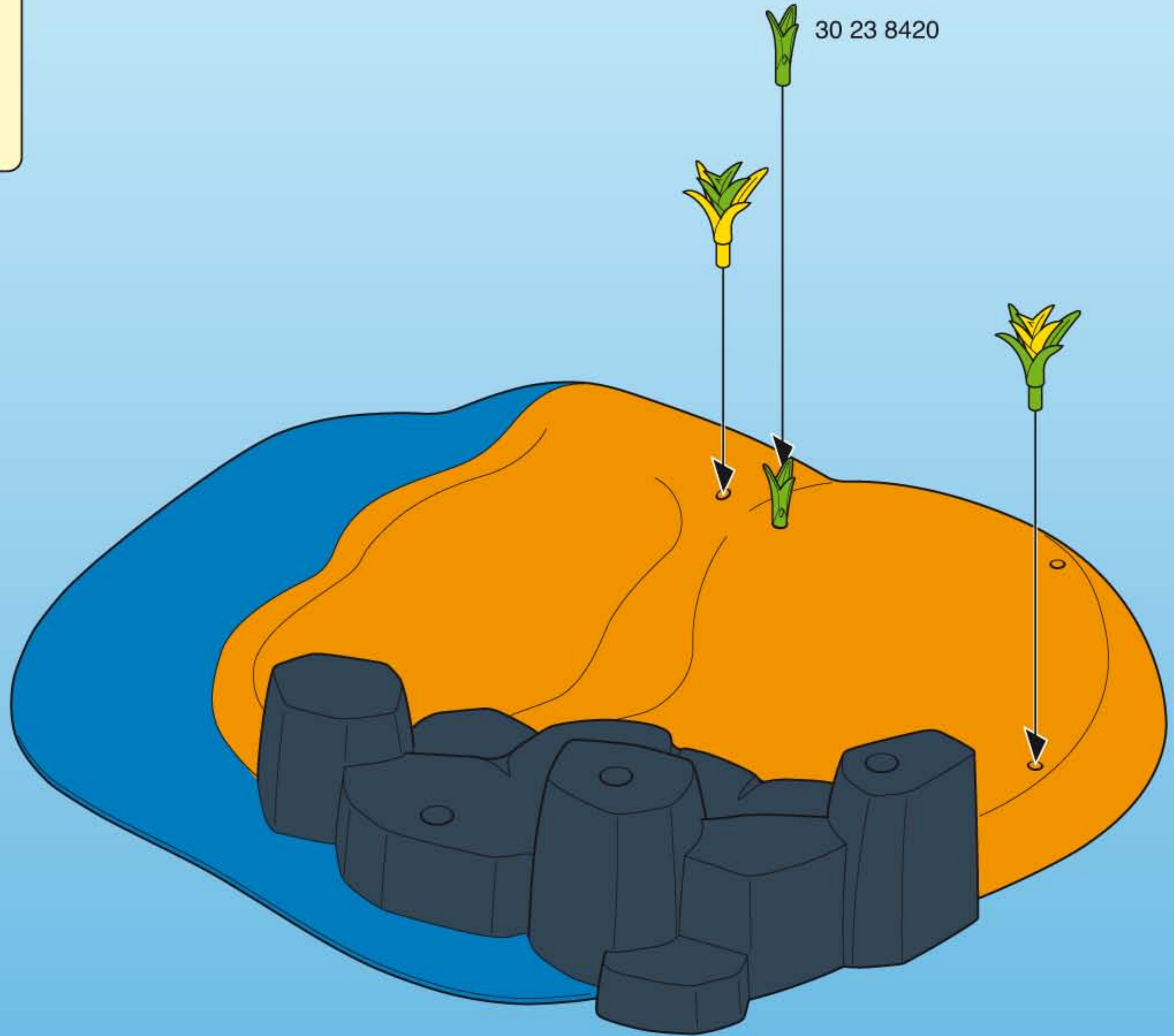

2

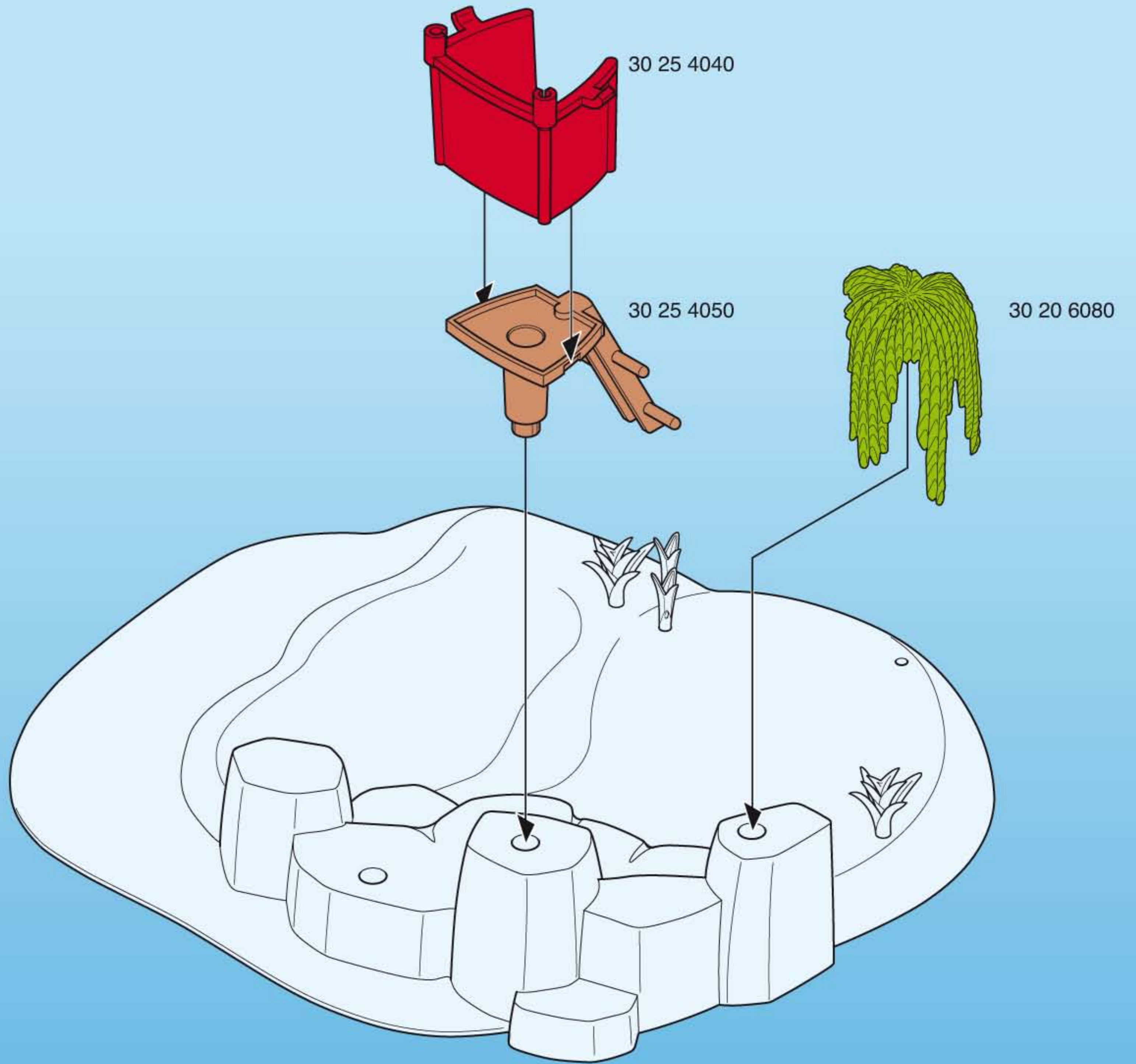



3

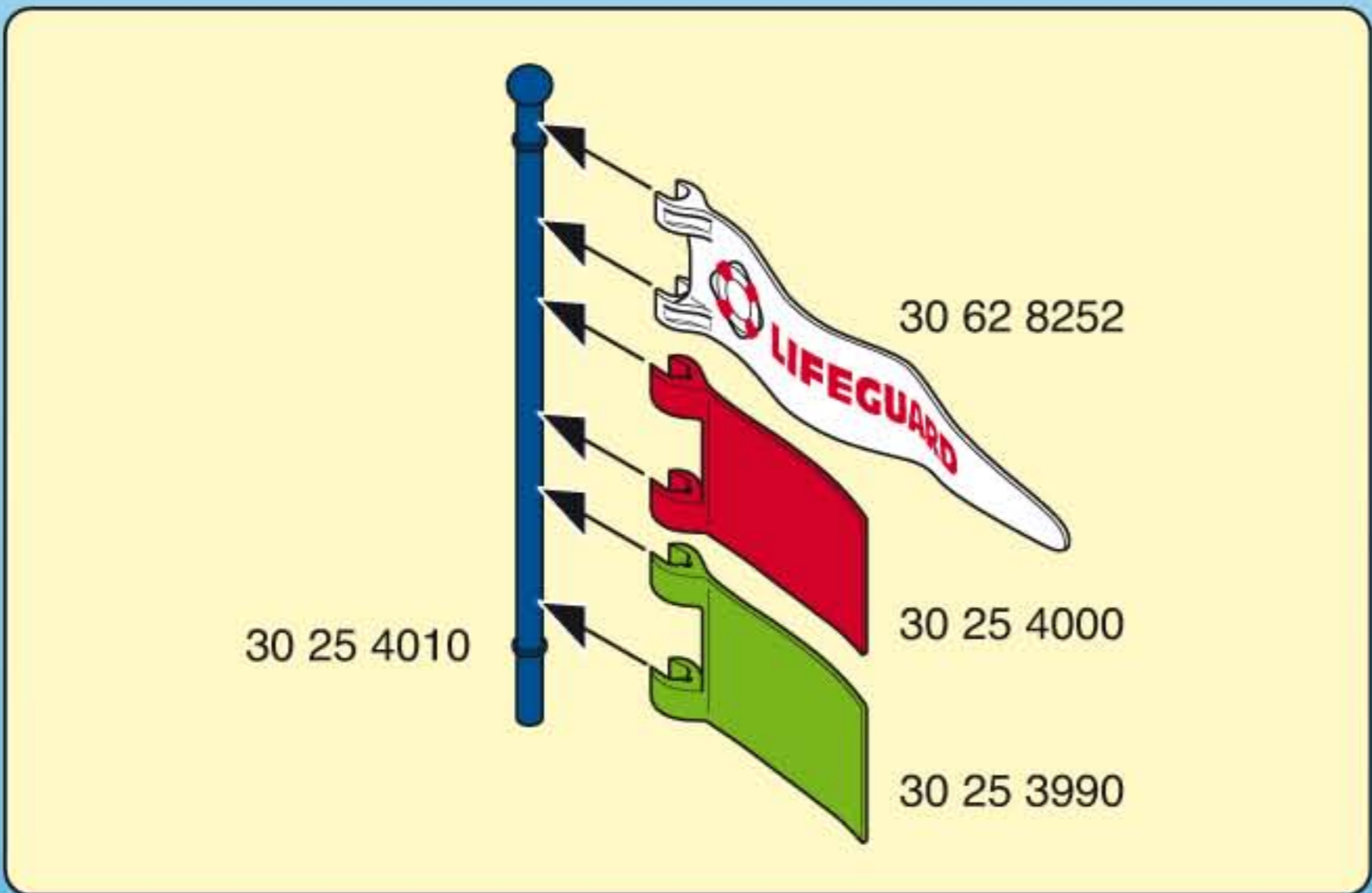
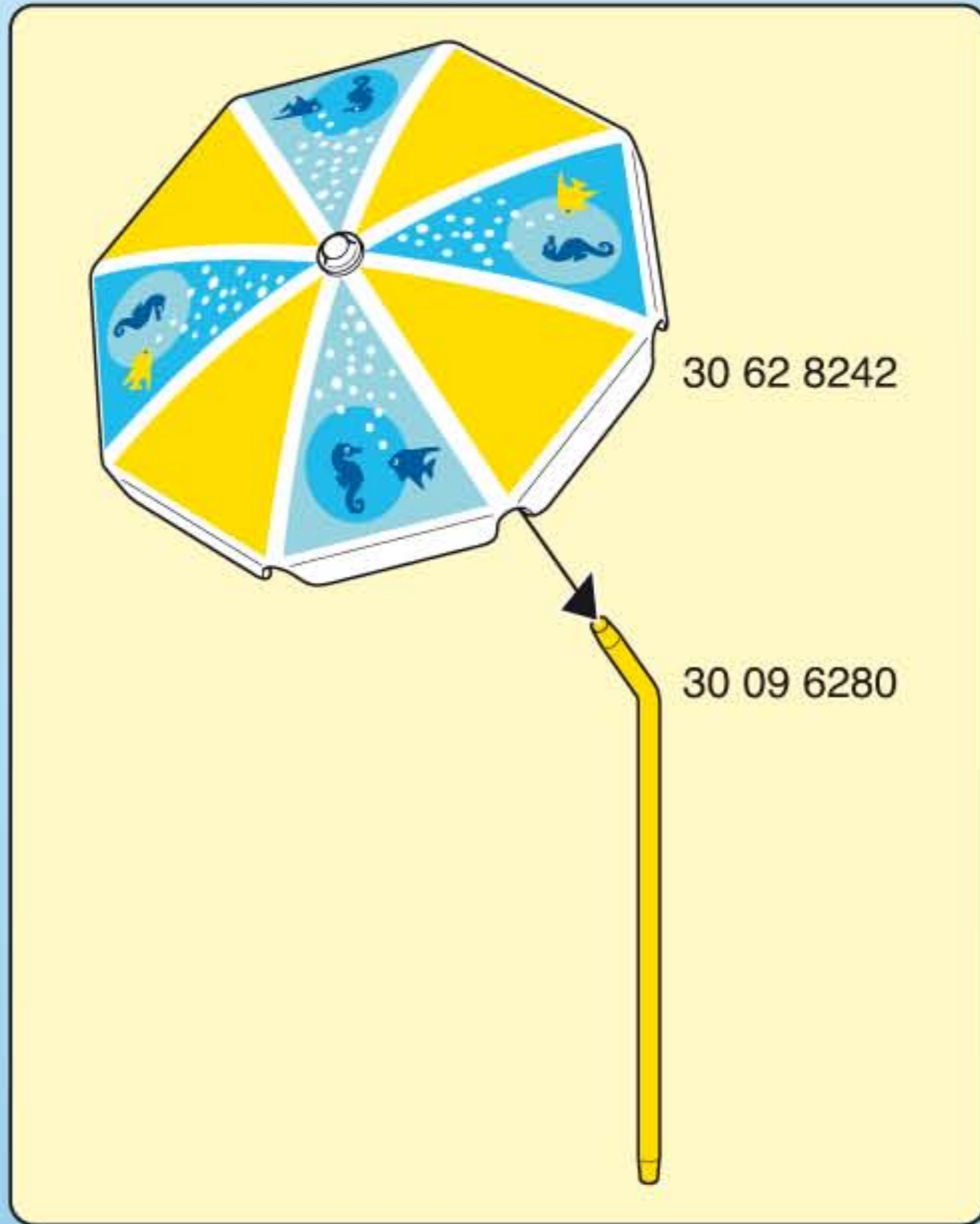
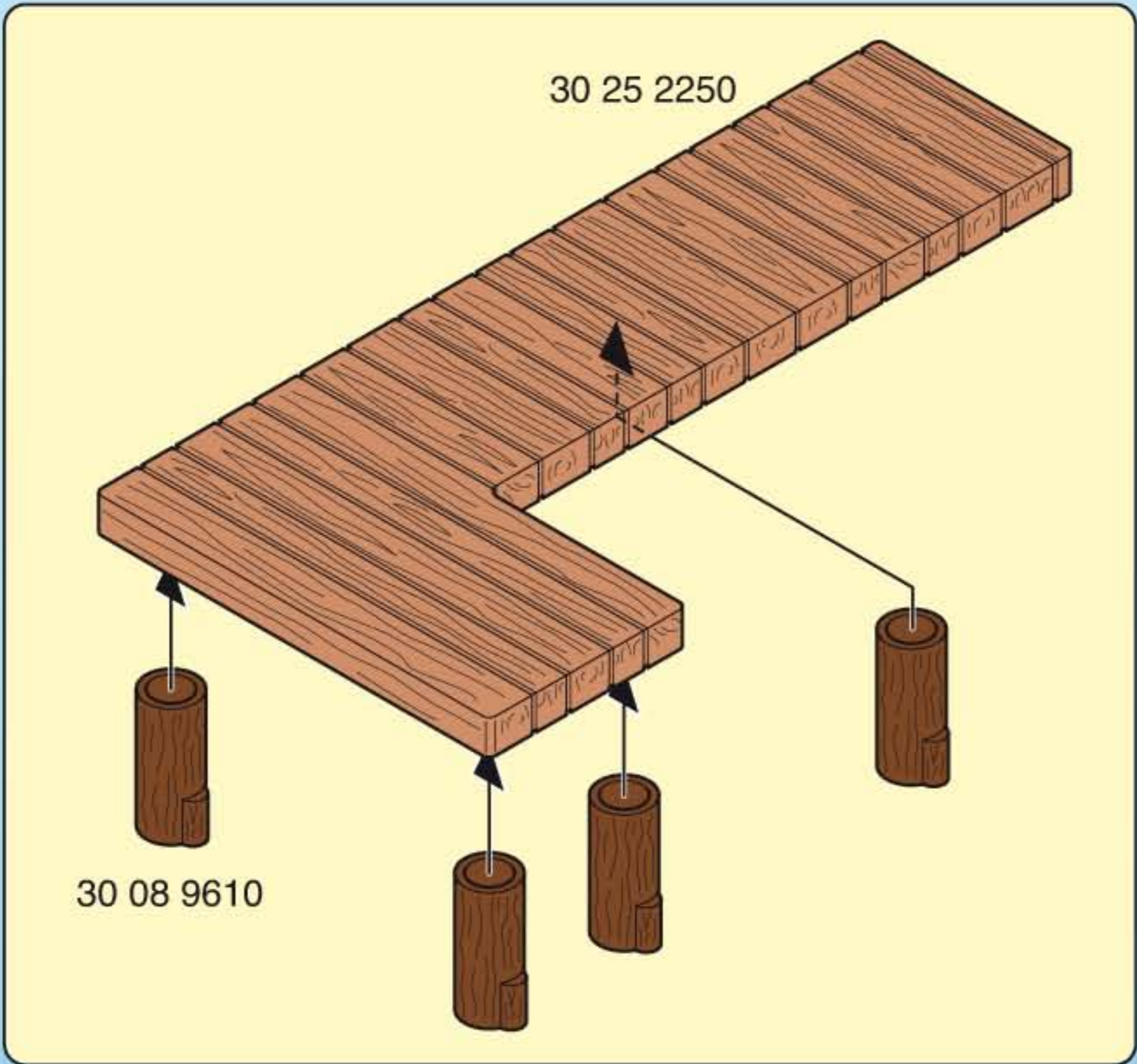



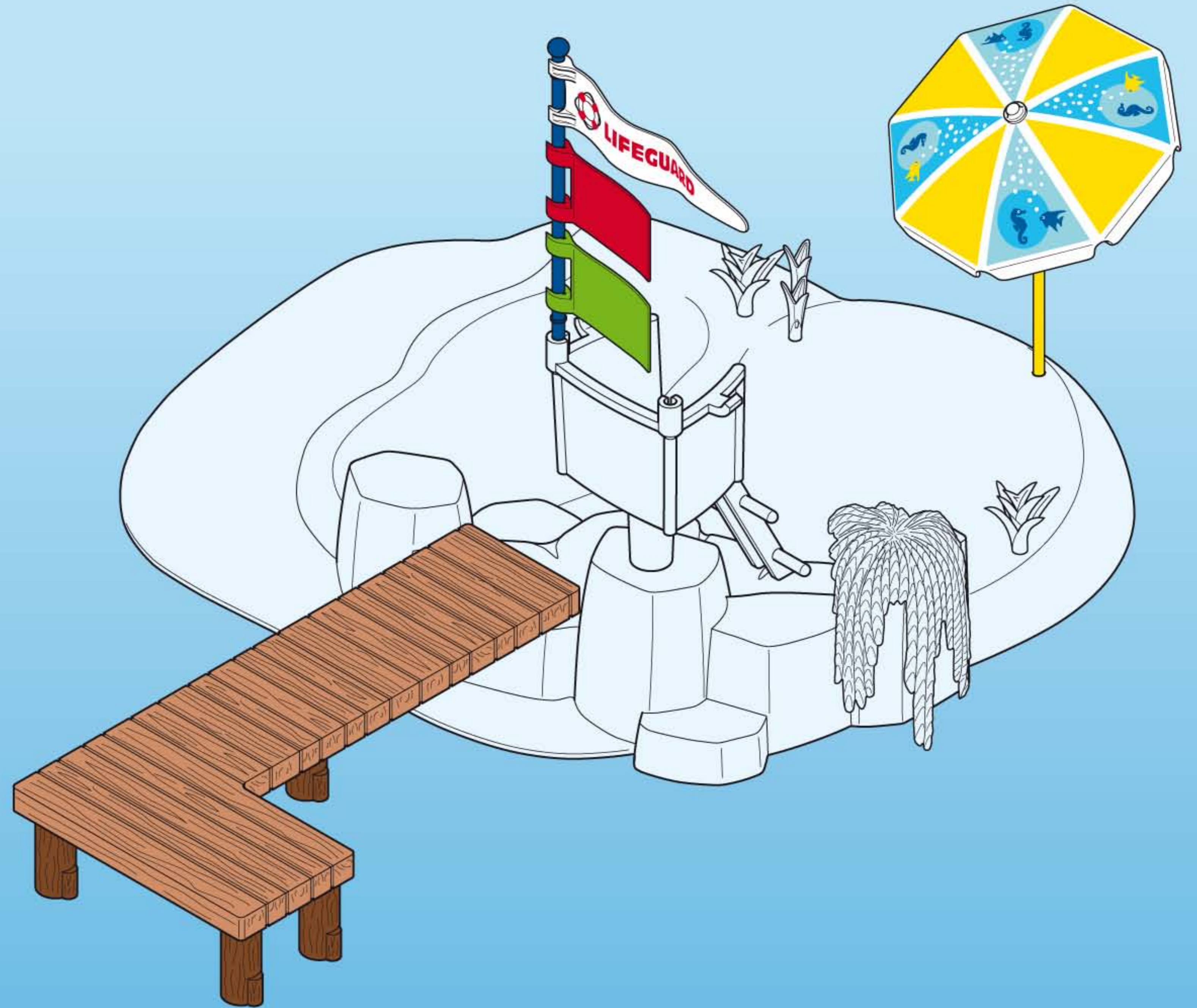



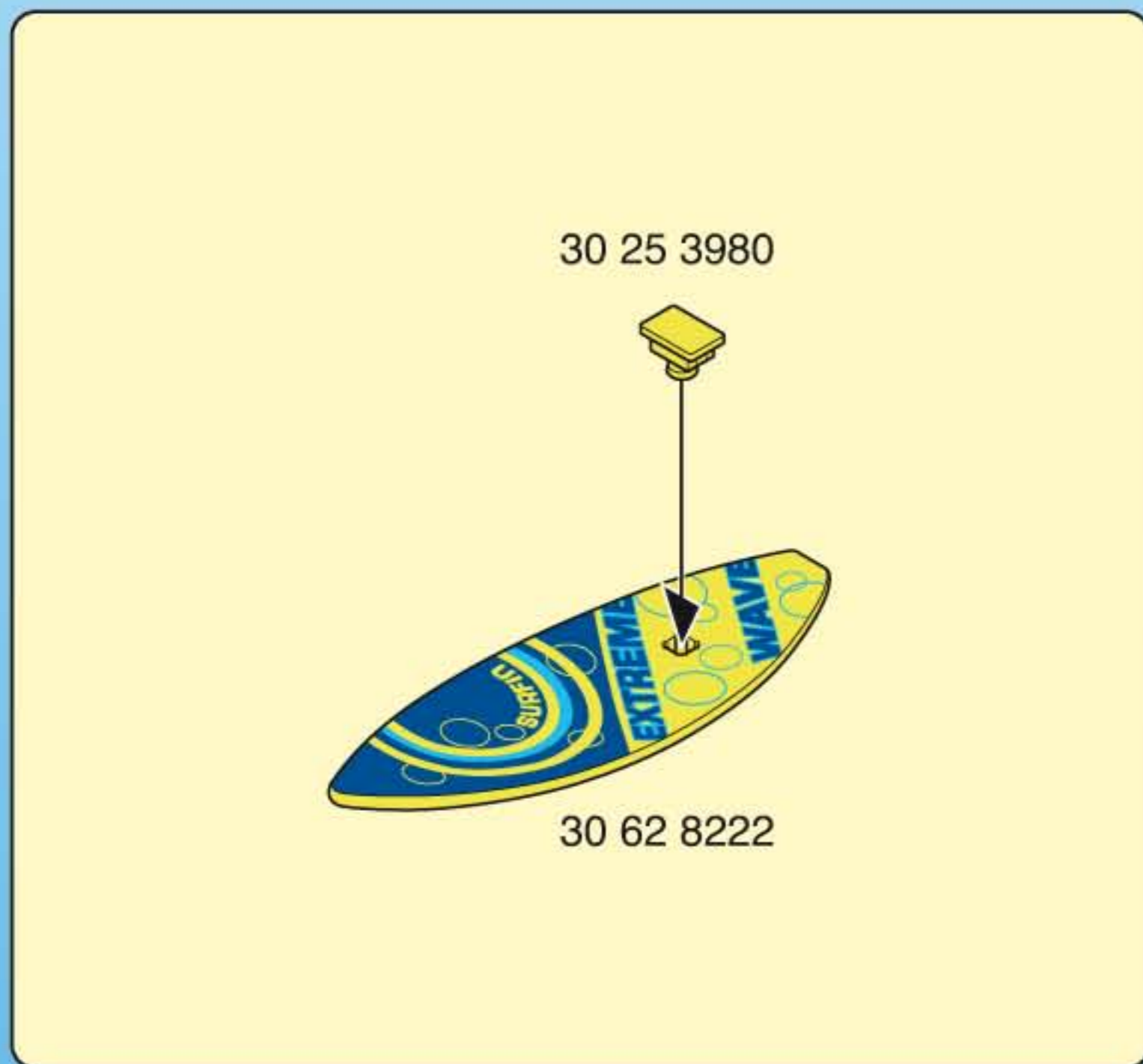
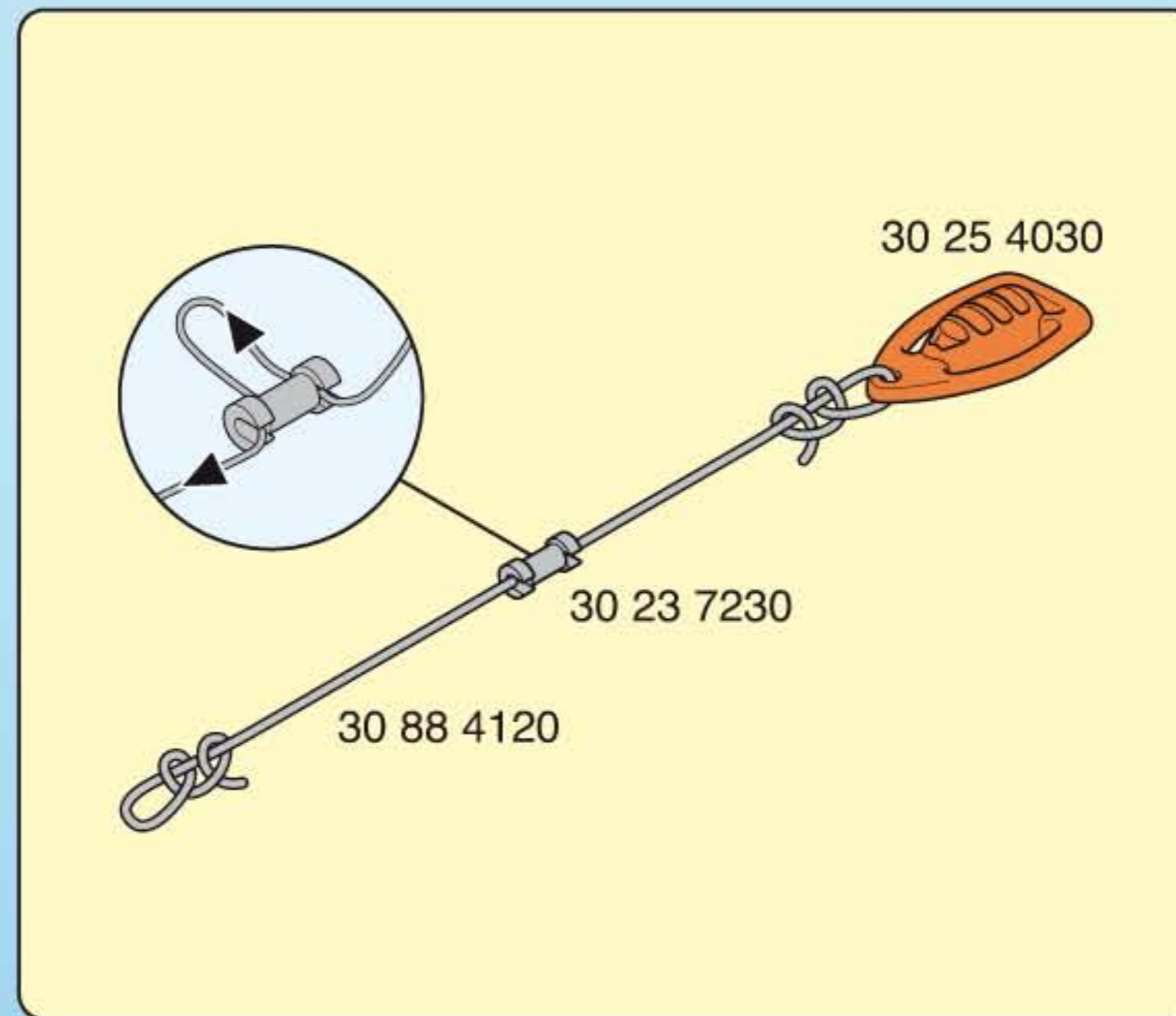
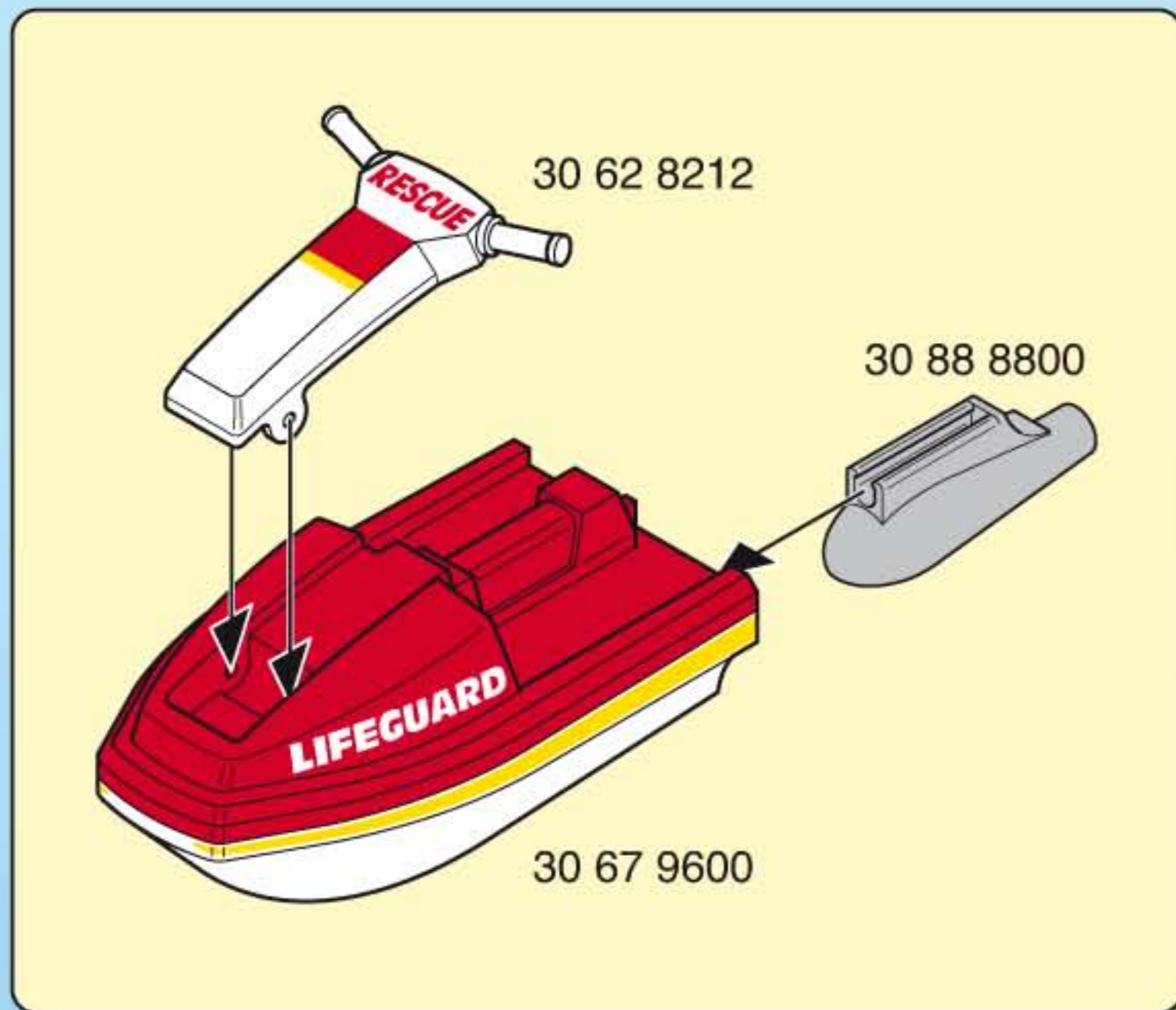



30 25 5080



30 00 1762

30 06 8090



30 00 1752



30 14 2580

30 25 3960



30 21 6840



30 11 1240

**D A CH L WARNING!**

Nur unter Aufsicht und nur in flachem Wasser benutzen.

**USA GB CDN M WARNING!**

Only to be used in water in which the child is within depth and under supervision

**F CDN B L CH ATTENTION!**

À n'utiliser qu'en eau où l'enfant a pied et sous surveillance.

**E MEX I ADVERTENCIA!**

Se deberá utilizar solamente en el agua, donde el niño haga pie y bajo vigilancia.

**NL B WAARSCHUWING!**

Alleen gebruiken onder toezicht, in water waarin het kind kan staan.

**I CH ATTENZIONE!**

Utilizzare solo in acque dove il bambino tocca con i piedi e sotto sorveglianza.

**P AVISO!**

Utilizar apenas em águas em que a criança tenha pé e sob vigilância.

**DK ADVARSEL!**

Må kun anvendes under opsyn og på vanddybder, hvor barnet kan bunde.

**N ADVARSEL!**

Skal kun brukes i vann som ikke er for dypt for barnet, og der barnet er under tilsyn.

**S FIN VARNING!**

Får endast användas på grunt vatten och under uppsikt av vuxen.

**FIN VAROITUS!**

Käytetään ainoastaan matalassa vedessä, jossa lapsi voi seistä ja on aikuisen valvonnassa.

**H FIGYELMEZTETÉS!**

Mély vízben nem használható! Kérjük, kizárólag szülői felügyelettel használja kis vízben!

**CZ VAROVÁNÍ!**

Používáť pouze v mělké vodě a pod dohledem!

**EST HOIATUS!**

Kasutamiseks ainult vees, kus lapse jalad ulatuvad põhja ja täiskasvanu järelevalve all.

**LV BRĪDINĀJUMS!**

Lietojams tikai seklā ūdenī un uzraudzībā.

**LT DĖMESIO!**

Naudoti prižiūrint suaugusiesiems ir tokiam gylje, kur vaikas gali stovėti.

**SLO OPOZORILO!**

Uporabljeni samo v plitvi vodi in pod nadzorom.

**SK UPOZORNENIE!**

Používať len vo vode primerane hĺbokej dieťaťu a pod dohľadom.

**PL UWAGA!**

Tylko do użytku w wodzie płytkiej i pod nadzorem.

**TR CY DIKKATI!**

Sadece denetim altında ve sadece alçak sularda kullanın.

**GR CY ΠΡΟΣΟΧΗ!**

Να χρησιμοποιείται μόνο σε νερά όπου πατώνει το παιδί και κάτω από επίβλεψη.



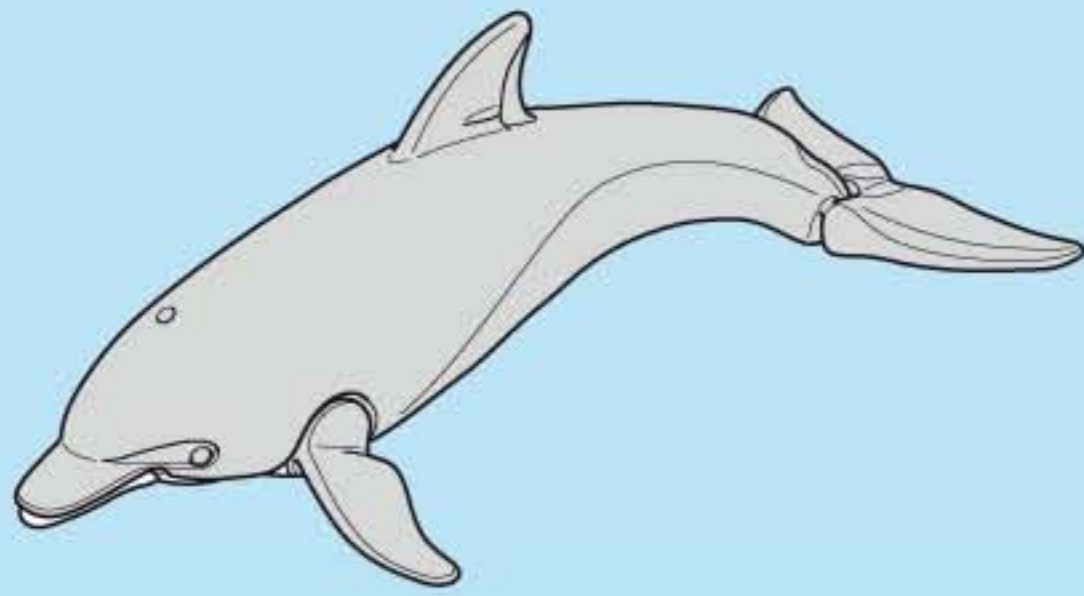

30 66 6010

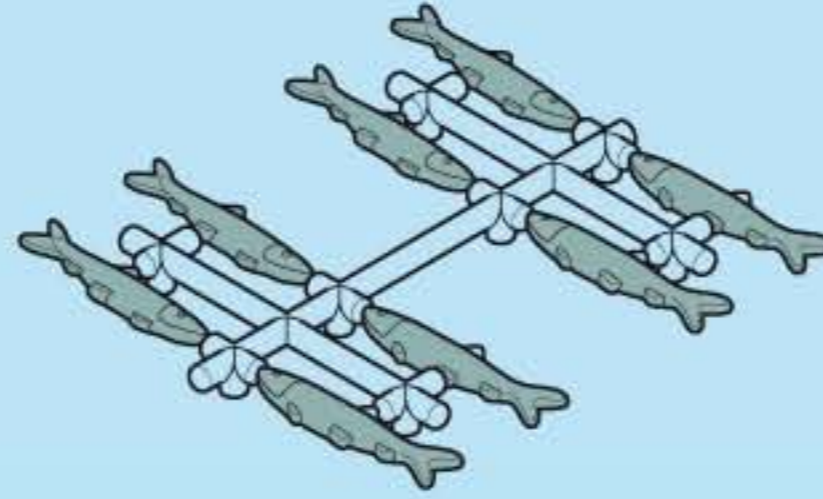

30 04 1270



30 67 0850



30 62 8232

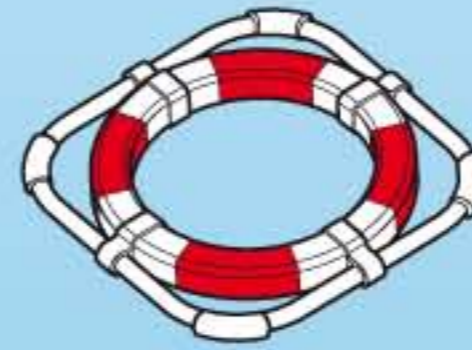

30 04 4720



30 25 4020

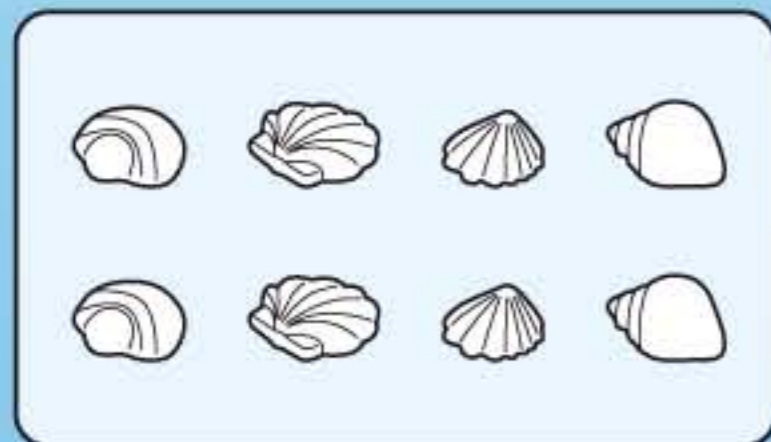

30 51 3380



30 09 9180



30 09 5550

Serviceadressen finden Sie in allen Playmobil-Prospekten

Addresses of Customer Service Departments are shown in all Playmobil catalogues

L'adresse du service consommateurs est indiquée dans tous les catalogues Playmobil

Troverete gli indirizzi dei centri di assistenza in tutti i cataloghi Playmobil

Las Direcciones de los Departamentos de Servicio al Consumidor se encuentran en todos los catálogos Playmobil

Η διεύθυνση του Γραφείου Εξυπηρέτησης Πελατών είναι καταχωρημένη σε όλους τους καταλόγους Playmobil

pronounce: plāy-mō-bēēl